

<b>What's in This Section</b>
-------------------------------

<b>Standard, Transom and Picture Windows</b> .....	<b>Page 3</b>
<b>Parts Illustration</b> .....	<b>3</b>
Parts Illustration .....	3
Color Options Exterior .....	4
Color / Finish Options Interior .....	5
<b>Unit Sizes</b> .....	<b>6</b>
Standard and Custom Window Sizes .....	6
A Series Product Label .....	6
Unit Size Chart - Standard Windows .....	7
Unit Size Chart - Picture Windows .....	9
<b>Product History</b> .....	<b>12</b>
Product History .....	12
<b>Sash</b> .....	<b>13</b>
Sash Size Table .....	13
Sash Illustration - Split Arm .....	22
Sash Illustration - Straight Arm .....	23
Sash Options .....	24
Sash Parts .....	25
Weatherstrip .....	26
<b>Glass</b> .....	<b>27</b>
Glass - Picture Windows .....	27
Glass Parts .....	28
<b>Insect Screens</b> .....	<b>29</b>
Insect Screen - TruScene® Screens .....	29
Insect Screen - Standard Screens .....	30
Insect Screen Parts .....	38
<b>Grilles</b> .....	<b>39</b>
Grilles - Standard / Interior .....	39
Interior Grille Parts .....	40
<b>Hardware</b> .....	<b>41</b>
Operator Chart .....	41
Split Arm Operator .....	42
Straight Arm Operator .....	44
Hinge Chart .....	46
Hinge Kits .....	47
Hinge Parts .....	48
Hardware Packs - Folding .....	49

Operator Covers .....	49
Operator Handles .....	50
Locks ( <i>October 2013 - present</i> ) .....	51
Locks ( <i>2008 - October 2013</i> ) .....	52
Lock Components .....	53
Installation Kit .....	54
Optional Hardware .....	55
Fasteners .....	56
<b>Frames .....</b>	<b>57</b>
Frame Assembly - Standard Windows .....	57
Frame - Standard Window .....	58
Frame Assembly - Picture Windows .....	59
Frame - Picture Window .....	60
Stops - Venting and Stationary Windows .....	61
Stops - Picture Windows .....	64
Extension Jambs .....	67
Stools .....	68
Frame Parts .....	69
<b>Joining Components .....</b>	<b>70</b>
Reinforced (Fiberglass) Joining Kit Exploded View .....	70
Reinforced (Fiberglass) Joining Kits .....	72
Reinforced (Fiberglass) Joining Kit Components .....	73
Miscellaneous Joining Components/Fasteners .....	78
Universal Drip Cap - Continuous .....	80
<b>Service Replacement .....</b>	<b>Page 81</b>
<b>Service Replacement Only Parts .....</b>	<b>81</b>
Service Replacement Only Parts .....	81
Exterior Grilles - Permanently Applied / Taped .....	81
Weatherstrip .....	83



# A-Series Casement & Picture Windows (2008 to Present)

Standard, Transom and Picture Windows

Parts Illustration

## Parts Illustration

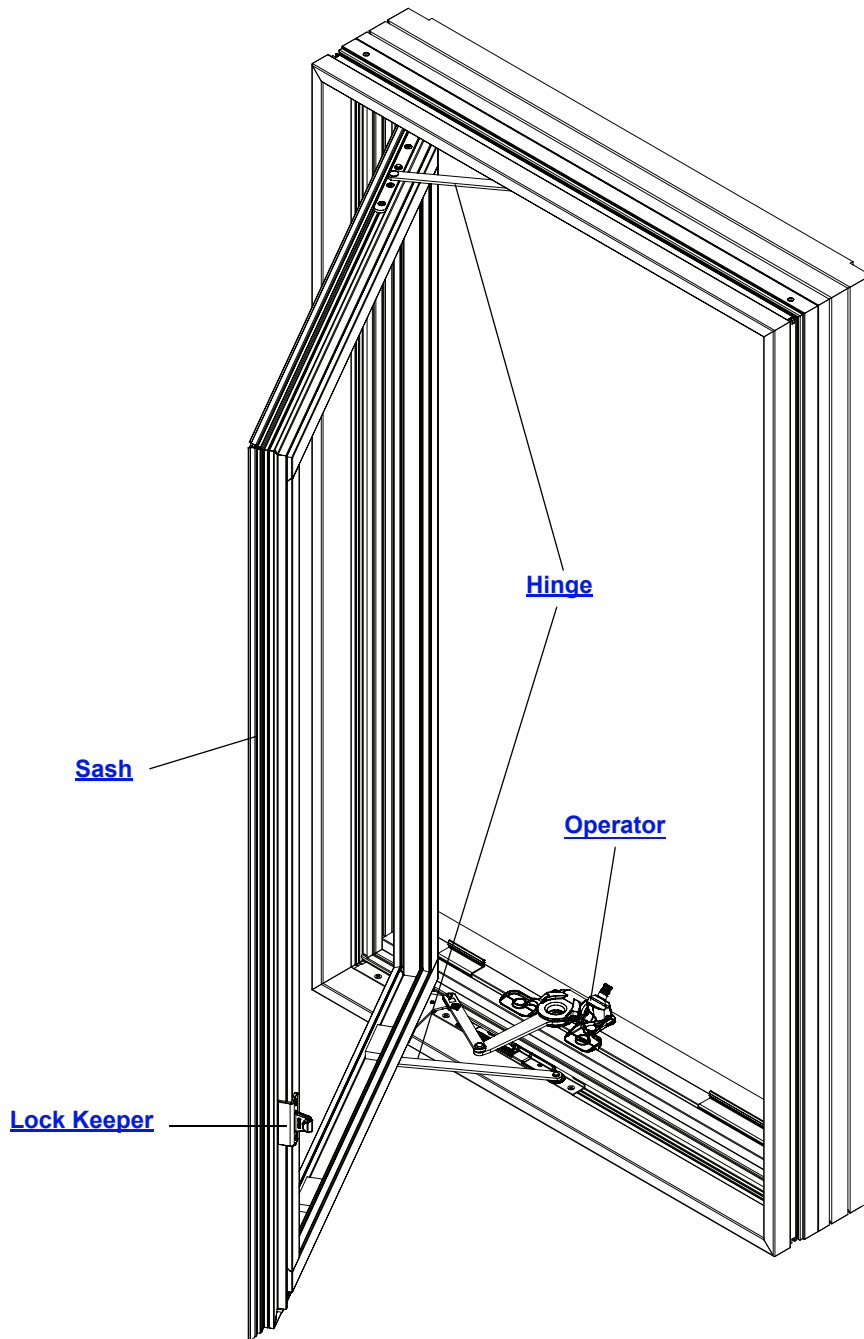

Manufactured 2008 to Present  
A-Series Casement Window Unit Parts

*Unit viewed from exterior.*

## Parts Illustration

### Color Options Exterior

Note:

[Latest Exterior color options.](#)

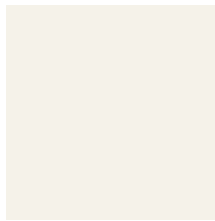

White

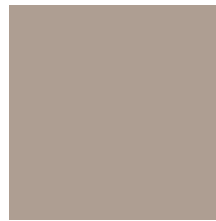

Sandtone

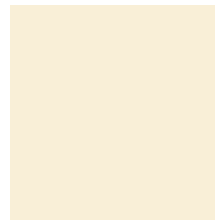

Canvas



Prairie Grass

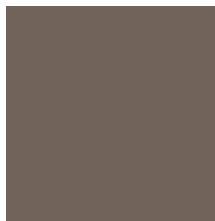

Terratone



Forest Green



Dove Gray

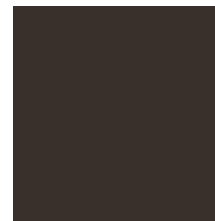

Dark Bronze

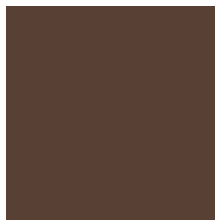

Cocoa Bean



Red Rock



Black

# A-Series Casement & Picture Windows (2008 to Present)

Standard, Transom and Picture Windows

## Parts Illustration

### Color / Finish Options Interior

**Note:**

See [interior species/finish/color options](#). See iQ+ for specific configuration options.

#### Interior Stains



Honey



Natural



Cinnamon



Russet



Mocha



Espresso

#### Interior Species



Pine

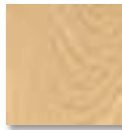

Maple



Vertical Grain  
Douglas Fir



Oak



Cherry



Mahogany

#### Interior Colors / Painted & Primed

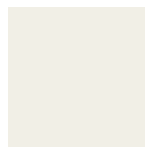

White

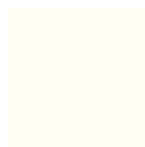

Birch Bark

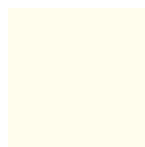

Primed



Sandtone



Canvas



Terratone



Forest Green



Dove Gray



Prairie Grass



Cocoa Bean



Red Rock

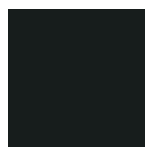

Black



Dark Bronze

## Unit Sizes

---

### Standard and Custom Window Sizes

**Note:**

A-Series Casement Windows are available in standard sizes (see standard size charts, [page 6](#)). Replacement parts for some standard windows can be ordered using the numbers listed in this catalog. Many replacement parts for standard windows are made to order. These items are ordered using the Product ID found on the identification label and a description of the part needed. See [Service Guide 9051877](#).

A-Series Casement Windows are also available in custom sizes in 1/8" increments between the smallest and the largest standard sizes. Most replacement parts for custom-sized windows are made to order and can be ordered with the Product ID found on the identification label and a description of the part needed. See [Service Guide 9051877](#).

### A Series Product Label

**Note:**

Every A-Series Casement Window will have an identification label or glass etching containing a unique Product ID. The Product ID on A-Series Casement Windows will be located at the bottom of the window frame underneath the sill stop or etched into the glass. See [Service Guide 9051877](#). The Product ID may be up to 14 digits long (excluding hyphens), depending on the age of the unit. Replacement parts will also get their own unique Product ID. When ordering replacement parts, providing the Product ID ensures that replacement parts match the specifications.

# A-Series Casement & Picture Windows (2008 to Present)

Standard, Transom and Picture Windows

## Unit Sizes

### Unit Size Chart - Standard Windows

**Note:**

Handing is viewed from exterior. Unit Dimension refers to overall outside-to-outside frame. Unobstructed Glass refers to visible glass dimensions. Numbers in parentheses are metric measurements. See latest [Size Grid](#).

**Table of Casement Window Sizes**  
Scale 1/8" (3) = 1'-0" (305)–1:96

Window Dimension	1'-7 1/8" (489)	1'-11 1/4" (591)	2'-3 1/4" (692)	2'-5 1/4" (743)	2'-7 1/4" (794)	2'-9 1/4" (845)	2'-11 1/4" (895)	3'-1 1/4" (946)	3'-3 1/4" (997)	3'-5 1/4" (1048)	3'-7 1/4" (1099)	3'-9 1/4" (1149)	3'-11 1/4" (1200)
Minimum Rough Opening	1'-8" (508)	2'-0" (610)	2'-4" (711)	2'-6" (762)	2'-8" (813)	2'-10" (864)	3'-0" (914)	3'-2" (965)	3'-4" (1016)	3'-6" (1067)	3'-8" (1118)	3'-10" (1168)	4'-0" (1219)
Unobstructed Glass	12 5/8" (320)	16 5/8" (422)	20 5/8" (523)	22 5/8" (574)	24 5/8" (625)	26 5/8" (676)	28 5/8" (726)	30 5/8" (777)	32 5/8" (828)	34 5/8" (879)	36 5/8" (930)	38 5/8" (981)	40 5/8" (1032)

**CUSTOM SIZES AVAILABLE**

Custom-size windows are available in 1/8" (3) increments.

Left Right Stationary

Choose left, right or stationary as viewed from the exterior.

Window models shown include: ACW1820, ACW2020, ACW2420, ACW1824, ACW2024, ACW2424, ACW2624, ACW2824, ACW1828, ACW2028, ACW2428, ACW2628, ACW2828, ACW21028, ACW3028, ACW1830, ACW2030, ACW2430, ACW2630, ACW2830, ACW21030, ACW3030, ACW3230\*\*†, ACW3430\*\*†, ACW1834, ACW2034, ACW2434, ACW2634, ACW2834, ACW21034, ACW3034, ACW3234\*\*†, ACW3434\*\*†, ACW3634\*\*†, ACW3834\*\*††, ACW1838, ACW2038, ACW2438, ACW2638\*\*†, ACW2838\*\*†, ACW21038\*\*†, ACW3038\*\*†, ACW3238\*\*††, ACW3438\*\*††, ACW3638\*\*††, ACW3838\*\*†††, ACW31038\*\*†††, ACW4038\*\*†††, ACW1840, ACW2040, ACW2440\*\*†, ACW2640\*\*†, ACW2840\*\*†, ACW21040\*\*†, ACW3040\*\*†, ACW3240\*\*††, ACW3440\*\*†††, ACW3640\*\*†††, ACW3840\*\*††††, ACW31040\*\*††††, ACW4040\*\*††††, ACW1844, ACW2044, ACW2444\*\*†, ACW2644\*\*†, ACW2844\*\*†, ACW21044\*\*†, ACW3044\*\*†, ACW3244\*\*††, ACW3444\*\*†††, ACW3644\*\*†††, ACW3844\*\*††††, ACW31044\*\*††††, ACW4044\*\*††††, ACW1848, ACW2048, ACW2448\*\*†, ACW2648\*\*†, ACW2848\*\*†, ACW21048\*\*†, ACW3048\*\*†, ACW3248\*\*††, ACW3448\*\*†††, ACW3648\*\*†††, ACW3848\*\*††††, ACW31048\*\*††††, ACW4048\*\*††††, ACW1850, ACW2050, ACW2450\*\*†, ACW2650\*\*†, ACW2850\*\*†, ACW21050\*\*†, ACW3050\*\*†, ACW3250\*\*††, ACW3450\*\*†††, ACW3650\*\*†††, ACW3850\*\*††††, ACW31050\*\*††††, ACW4050\*\*††††, ACW1854, ACW2054, ACW2454\*\*†, ACW2654\*\*†, ACW2854\*\*†, ACW21054\*\*†, ACW3054\*\*†, ACW3254\*\*††, ACW3454\*\*†††, ACW3654\*\*†††, ACW3854\*\*††††, ACW31054\*\*††††, ACW4054\*\*††††, ACW1858, ACW2058, ACW2458\*\*†, ACW2658\*\*†, ACW2858\*\*†, ACW21058\*\*†, ACW3058\*\*†, ACW3258\*\*††, ACW3458\*\*†††, ACW3658\*\*†††, ACW3858\*\*††††, ACW31058\*\*††††, ACW4058\*\*††††.

\* "Window Dimension" always refers to outside frame to frame dimension.  
 \*\* "Minimum Rough Opening" dimensions may need to be increased to allow for use of building wraps, flashing, sill panning, brackets, fasteners or other items.  
 † Dimensions in parentheses are in millimeters.  
 ‡ Meet or exceed clear opening area of 5.7 sq.ft. or 0.53 m<sup>2</sup>; clear opening width of 20" (508) and clear opening height of 24" (610).  
 †† Available with straight-arm operators only; all other sizes have split-arm operators only.  
 ††† Not available with triple-pane annealed glass.  
 †††† Not available with triple-pane annealed or tempered glass.

### A-Series Casement Standard Window Unit Sizes

Unit viewed from exterior.

# Unit Sizes

## Unit Size Chart - Standard Windows

### Note:

Handing is viewed from exterior. Unit Dimension refers to overall outside-to-outside frame. Unobstructed Glass refers to visible glass dimensions. Numbers in parentheses are metric measurements. See latest [Size Grid](#).

**Table of Casement Window Sizes** (continued)  
Scale 1/8" (3) = 1'-0" (305)– 1:96

Notes on the previous page also apply to this page.

Window Dimension	1'-7 1/4"	1'-11 1/4"	2'-3 1/4"	2'-5 1/4"	2'-7 1/4"	2'-9 1/4"	2'-11 1/4"	3'-1 1/4"	3'-3 1/4"	3'-5 1/4"	3'-7 1/4"	3'-9 1/4"	3'-11 1/4"
Minimum	1'-8"	2'-0"	2'-4"	2'-6"	2'-8"	2'-10"	3'-0"	3'-2"	3'-4"	3'-6"	3'-8"	3'-10"	4'-0"
Rough Opening	(508)	(610)	(711)	(762)	(813)	(864)	(914)	(965)	(1016)	(1067)	(1118)	(1168)	(1219)
Unobstructed Glass	12 5/8"	16 5/8"	20 5/8"	22 5/8"	24 5/8"	26 5/8"	28 5/8"	30 5/8"	32 5/8"	34 5/8"	36 5/8"	38 5/8"	40 5/8"
	(320)	(422)	(523)	(574)	(625)	(676)	(726)	(777)	(828)	(879)	(930)	(1031)	(1133)

Window Dimension	CUSTOM SIZES AVAILABLE												
	1'-7 1/4"	1'-11 1/4"	2'-3 1/4"	2'-5 1/4"	2'-7 1/4"	2'-9 1/4"	2'-11 1/4"	3'-1 1/4"	3'-3 1/4"	3'-5 1/4"	3'-7 1/4"	3'-9 1/4"	3'-11 1/4"
5'-11 1/4"	(1910)	6'-0"	(1929)	63 13/16"	(1921)								
	ACW1860 <sup>††</sup>	ACW2060 <sup>††</sup>	ACW2460 <sup>††</sup>	ACW2660 <sup>††</sup>	ACW2860 <sup>††</sup>	ACW21060 <sup>††</sup>	ACW3060 <sup>††</sup>	ACW3260 <sup>††</sup>	ACW3460 <sup>††</sup>	ACW3660 <sup>††</sup>	ACW3860 <sup>††</sup>	ACW31060 <sup>††</sup>	ACW4060 <sup>††</sup>
6'-3 1/4"	(1911)	6'-4"	(1930)	67 13/16"	(1722)								
	ACW1864 <sup>††</sup>	ACW2064 <sup>††</sup>	ACW2464 <sup>††</sup>	ACW2664 <sup>††</sup>	ACW2864 <sup>††</sup>	ACW21064 <sup>††</sup>	ACW3064 <sup>††</sup>	ACW3264 <sup>††</sup>	ACW3464 <sup>††</sup>	ACW3664 <sup>††</sup>	ACW3864 <sup>††</sup>	ACW31064 <sup>††</sup>	ACW4064 <sup>††</sup>
6'-7 1/4"	(2013)	6'-8"	(2032)	71 13/16"	(1824)								
	ACW1868 <sup>††</sup>	ACW2068 <sup>††</sup>	ACW2468 <sup>††</sup>	ACW2668 <sup>††</sup>	ACW2868 <sup>††</sup>	ACW21068 <sup>††</sup>	ACW3068 <sup>††</sup>	ACW3268 <sup>††</sup>	ACW3468 <sup>††</sup>	ACW3668 <sup>††</sup>	ACW3868 <sup>††</sup>	ACW31068 <sup>††</sup>	ACW4068 <sup>††</sup>
6'-11 1/4"	(2115)	7'-0"	(2134)	75 13/16"	(1925)								
	ACW1870 <sup>††</sup>	ACW2070 <sup>††</sup>	ACW2470 <sup>††</sup>	ACW2670 <sup>††</sup>	ACW2870 <sup>††</sup>	ACW21070 <sup>††</sup>	ACW3070 <sup>††</sup>	ACW3270 <sup>††</sup>	ACW3470 <sup>††</sup>	ACW3670 <sup>††</sup>	ACW3870 <sup>††</sup>	ACW31070 <sup>††</sup>	ACW4070 <sup>††</sup>
7'-3 1/4"	(2216)	7'-4"	(2235)	79 13/16"	(2027)								
	ACW1874 <sup>††</sup>	ACW2074 <sup>††</sup>	ACW2474 <sup>††</sup>	ACW2674 <sup>††</sup>	ACW2874 <sup>††</sup>	ACW21074 <sup>††</sup>	ACW3074 <sup>††</sup>	ACW3274 <sup>††</sup>	ACW3474 <sup>††</sup>	ACW3674 <sup>††</sup>	ACW3874 <sup>††</sup>	ACW31074 <sup>††</sup>	ACW4074 <sup>††</sup>
7'-7 1/4"	(2318)	7'-8"	(2337)	83 13/16"	(2129)								
	ACW1878 <sup>††</sup>	ACW2078 <sup>††</sup>	ACW2478 <sup>††</sup>	ACW2678 <sup>††</sup>	ACW2878 <sup>††</sup>	ACW21078 <sup>††</sup>	ACW3078 <sup>††</sup>	ACW3278 <sup>††</sup>	ACW3478 <sup>††</sup>	ACW3678 <sup>††</sup>	ACW3878 <sup>††</sup>	ACW31078 <sup>††</sup>	ACW4078 <sup>††</sup>
7'-11 1/4"	(2419)	8'-0"	(2438)	87 13/16"	(2230)								
	ACW1880 <sup>††</sup>	ACW2080 <sup>††</sup>	ACW2480 <sup>††</sup>	ACW2680 <sup>††</sup>	ACW2880 <sup>††</sup>	ACW21080 <sup>††</sup>	ACW3080 <sup>††</sup>	ACW3280 <sup>††</sup>	ACW3480 <sup>††</sup>	ACW3680 <sup>††</sup>	ACW3880 <sup>††</sup>	ACW31080 <sup>††</sup>	ACW4080 <sup>††</sup>

- \* "Window Dimension" always refers to outside frame to frame dimension.
- \* "Minimum Rough Opening" dimensions may need to be increased to allow for use of building wraps, flashing, sill panning, brackets, fasteners or other items.
- \* Dimensions in parentheses are in millimeters.
- † Meet or exceed clear opening area of 5.7 sq.ft. or 0.53 m<sup>2</sup>, clear opening width of 20" (508) and clear opening height of 24" (610).
- †† Meet or exceed clear opening area of 5.7 sq.ft. or 0.53 m<sup>2</sup>, clear opening width of 20" (508) and clear opening height of 24" (610) with a limited sash opening.
- ††† Available with straight-arm operators only; all other sizes have split-arm operators only.
- †††† Available with triple-pane annealed glass.
- ††††† Not available with triple-pane annealed or tempered glass.

### A-Series Casement Standard Window Unit Sizes

# A-Series Casement & Picture Windows (2008 to Present)

Standard, Transom and Picture Windows

## Unit Sizes

### Unit Size Chart - Picture Windows

**Note:**

Unit Dimension refers to overall outside-to-outside frame. Unobstructed Glass refers to visible glass dimensions. Numbers in parentheses are metric measurements. See latest [Size Grid](#) in Product Guide (pages 50-54).

Unit Dimension	1'-3 <sup>1</sup> / <sub>4</sub> " (387)	1'-7 <sup>1</sup> / <sub>4</sub> " (489)	1'-11 <sup>1</sup> / <sub>4</sub> " (591)	2'-3 <sup>1</sup> / <sub>4</sub> " (692)	2'-5 <sup>1</sup> / <sub>4</sub> " (743)	2'-7 <sup>1</sup> / <sub>4</sub> " (794)	2'-9 <sup>1</sup> / <sub>4</sub> " (845)	2'-11 <sup>1</sup> / <sub>4</sub> " (895)	3'-1 <sup>1</sup> / <sub>4</sub> " (946)	3'-3 <sup>1</sup> / <sub>4</sub> " (997)	3'-7 <sup>1</sup> / <sub>4</sub> " (1099)	3'-11 <sup>1</sup> / <sub>4</sub> " (1200)	4'-3 <sup>1</sup> / <sub>4</sub> " (1302)
Minimum Rough Opening	1'-4" (406)	1'-8" (508)	2'-0" (610)	2'-4" (711)	2'-6" (762)	2'-8" (813)	2'-10" (864)	3'-0" (914)	3'-2" (965)	3'-4" (1016)	3'-8" (1118)	4'-0" (1219)	4'-4" (1321)
Unobstructed Glass	8 5/8" (219)	12 5/8" (321)	16 5/8" (422)	20 5/8" (524)	22 5/8" (575)	24 5/8" (625)	26 5/8" (676)	28 5/8" (727)	30 5/8" (778)	32 5/8" (829)	36 5/8" (930)	40 5/8" (1032)	44 5/8" (1133)
1'-11 <sup>1</sup> / <sub>4</sub> " (591)													
2'-3 <sup>1</sup> / <sub>4</sub> " (692)													
2'-7 <sup>1</sup> / <sub>4</sub> " (794)													
2'-11 <sup>1</sup> / <sub>4</sub> " (895)													
3'-3 <sup>1</sup> / <sub>4</sub> " (997)													
3'-7 <sup>1</sup> / <sub>4</sub> " (1099)													
3'-11 <sup>1</sup> / <sub>4</sub> " (1200)													
4'-3 <sup>1</sup> / <sub>4</sub> " (1302)													
4'-7 <sup>1</sup> / <sub>4</sub> " (1403)													
4'-11 <sup>1</sup> / <sub>4</sub> " (1505)													
5'-3 <sup>1</sup> / <sub>4</sub> " (1607)													
5'-7 <sup>1</sup> / <sub>4</sub> " (1708)													
5'-11 <sup>1</sup> / <sub>4</sub> " (1810)													

### A-Series Casement Picture Window Unit Sizes

Unit viewed from exterior.

## Unit Sizes

### Unit Size Chart - Picture Windows

**Note:**

Unit Dimension refers to overall outside-to-outside frame. Unobstructed Glass refers to visible glass dimensions. Numbers in parentheses are metric measurements. See latest [Size Grid](#) in Product Guide (pages 50-54).

Unit Dimension	4'-7 1/4" (1403)	4'-11 1/4" (1505)	5'-3 1/4" (1607)	5'-7 1/4" (1708)	5'-11 1/4" (1810)
<b>Minimum Rough Opening</b>	4'-8" (1422)	5'-0" (1524)	5'-4" (1626)	5'-8" (1727)	6'-0" (1829)
<b>Unobstructed Glass</b>	48 5/8" (1335)	52 5/8" (1337)	56 5/8" (1438)	60 5/8" (1540)	64 5/8" (1641)
1'-11 1/4" (591)	2'-0" (610)	2'-0" (610)	2'-0" (610)	2'-0" (610)	2'-0" (610)
2'-3 1/4" (692)	2'-4" (711)	2'-4" (711)	2'-4" (711)	2'-4" (711)	2'-4" (711)
2'-7 1/4" (794)	2'-8" (813)	2'-8" (813)	2'-8" (813)	2'-8" (813)	2'-8" (813)
2'-11 1/4" (895)	3'-0" (914)	3'-0" (914)	3'-0" (914)	3'-0" (914)	3'-0" (914)
3'-3 1/4" (997)	3'-4" (1016)	3'-4" (1016)	3'-4" (1016)	3'-4" (1016)	3'-4" (1016)
3'-7 1/4" (1099)	3'-8" (1118)	3'-8" (1118)	3'-8" (1118)	3'-8" (1118)	3'-8" (1118)
3'-11 1/4" (1200)	4'-0" (1219)	4'-0" (1219)	4'-0" (1219)	4'-0" (1219)	4'-0" (1219)
4'-3 1/4" (1302)	4'-4" (1321)	4'-4" (1321)	4'-4" (1321)	4'-4" (1321)	4'-4" (1321)
4'-7 1/4" (1403)	4'-8" (1422)	4'-8" (1422)	4'-8" (1422)	4'-8" (1422)	4'-8" (1422)
4'-11 1/4" (1505)	5'-0" (1524)	5'-0" (1524)	5'-0" (1524)	5'-0" (1524)	5'-0" (1524)
5'-3 1/4" (1607)	5'-4" (1626)	5'-4" (1626)	5'-4" (1626)	5'-4" (1626)	5'-4" (1626)
5'-7 1/4" (1708)	5'-8" (1727)	5'-8" (1727)	5'-8" (1727)	5'-8" (1727)	5'-8" (1727)
5'-11 1/4" (1810)	6'-0" (1829)	6'-0" (1829)	6'-0" (1829)	6'-0" (1829)	6'-0" (1829)
	63 1/2" (1621)	63 1/2" (1621)	63 1/2" (1621)	63 1/2" (1621)	63 1/2" (1621)
	APW4820	APW5020	APW5420	APW5820	APW6020
	APW4824	APW5024	APW5424	APW5824	APW6024
	APW4828	APW5028	APW5428	APW5828	APW6028
	APW4830	APW5030	APW5430	APW5830	APW6030
	APW4834	APW5034	APW5434	APW5834	APW6034
	APW4838	APW5038	APW5438	APW5838	APW6038
	APW4840	APW5040	APW5440	APW5840	APW6040
	APW4844	APW5044	APW5444	APW5844	APW6044
	APW4848	APW5048	APW5448	APW5848	APW6048
	APW4850	APW5050	APW5450	APW5850	APW6050
	APW4854	APW5054	APW5454	APW5854	APW6054
	APW4858	APW5058	APW5458	APW5858	APW6058
	APW4860	APW5060	APW5460	APW5860	APW6060

### A-Series Casement Picture Window Unit Sizes

*Unit viewed from exterior.*



# A-Series Casement & Picture Windows (2008 to Present)

Standard, Transom and Picture Windows

## Unit Sizes

### Unit Size Chart - Picture Windows

**Note:**

Unit Dimension refers to overall outside-to-outside frame. Unobstructed Glass refers to visible glass dimensions. Numbers in parentheses are metric measurements. See latest [Size Grid](#) in Product Guide (pages 50-54).

Unit Dimension	1'-3 1/4" (387)	1'-7 1/4" (489)	1'-11 1/4" (591)	2'-3 1/4" (692)	2'-5 1/4" (743)	2'-7 1/4" (794)	2'-9 1/4" (845)	2'-11 1/4" (895)	3'-1 1/4" (946)	3'-3 1/4" (997)	3'-7 1/4" (1099)	3'-11 1/4" (1200)	4'-3 1/4" (1302)
Minimum Rough Opening	1'-4" (406)	1'-8" (508)	2'-0" (610)	2'-4" (711)	2'-6" (762)	2'-8" (813)	2'-10" (864)	3'-0" (914)	3'-2" (965)	3'-4" (1016)	3'-8" (1118)	4'-0" (1219)	4'-4" (1321)
Unobstructed Glass	8 5/8" (219)	12 5/8" (321)	16 5/8" (422)	20 5/8" (524)	22 5/8" (575)	24 5/8" (625)	26 5/8" (676)	28 5/8" (727)	30 5/8" (778)	32 5/8" (829)	36 5/8" (930)	40 5/8" (1032)	44 5/8" (1133)
6'-3 1/4" (1911)													
	APW1464	APW1864	APW2064	APW2464	APW2664	APW2864	APW21064	APW3064	APW3264	APW3464	APW3864	APW4064	APW4464
6'-7 1/4" (2013)													
	APW1468	APW1868	APW2068	APW2468	APW2668	APW2868	APW21068	APW3068	APW3268	APW3468	APW3868	APW4068	APW4468
7'-3 1/4" (2216)													
	APW1474	APW1874	APW2074	APW2474	APW2674	APW2874	APW21074	APW3074	APW3274	APW3474	APW3874	APW4074	APW4474
7'-11 1/4" (2419)													
	APW1480	APW1880	APW2080	APW2480	APW2680	APW2880	APW21080	APW3080	APW3280	APW3480	APW3880	APW4080	APW4480

**A-Series Casement Picture Window Unit Sizes**

*Unit viewed from exterior.*

## Product History

---

### Product History

- 2022** PG Upgrade introduced.
- 2019** Additional Stormwatch® sizes up to 3680 introduced.
- 2018** Additional Stormwatch® sizes up to 31074 introduced.
- 2016** Monumental sizes up to 4080 introduced.
- 2016** Triple pane glass introduced.
- 2015** HeatLock™ glass introduced.
- 2015** Vertical Grain Douglas Fir, Cherry and Mahogany interior species introduced.
- 2013** Additional Tandem, Triple Lock/Keeper configurations introduced.
- 2012** Stormwatch® protection introduced.
- 2012** Distressed Nickel finish for traditional style folding hardware introduced.
- 2008** SmartSun™ glass introduced.
- 2008** Casement Window introduced.

# A-Series Casement & Picture Windows (2008 to Present)

Standard, Transom and Picture Windows

## Sash

### Sash Size Table

**Note:**

Overall Sash is measured outside edge to outside edge of frame.

Unobstructed Glass is dimension from outside edge to outside edge of visible glass only.

See [Measuring Visible Glass Video](#).

Sash Size Table - Standard Windows			
Unit No.	Overall Sash (w x h)	Unobstructed Glass (w x h)	
<b>18</b>	<b>ACW1820</b>	17 <sup>9</sup> / <sub>32</sub> x 21 <sup>9</sup> / <sub>32</sub>	12 <sup>5</sup> / <sub>8</sub> x 15 <sup>13</sup> / <sub>16</sub>
	<b>ACW1824</b>	17 <sup>9</sup> / <sub>32</sub> x 25 <sup>9</sup> / <sub>32</sub>	12 <sup>5</sup> / <sub>8</sub> x 19 <sup>13</sup> / <sub>16</sub>
	<b>ACW1828</b>	17 <sup>9</sup> / <sub>32</sub> x 29 <sup>9</sup> / <sub>32</sub>	12 <sup>5</sup> / <sub>8</sub> x 23 <sup>13</sup> / <sub>16</sub>
	<b>ACW1830</b>	17 <sup>9</sup> / <sub>32</sub> x 33 <sup>9</sup> / <sub>32</sub>	12 <sup>5</sup> / <sub>8</sub> x 27 <sup>13</sup> / <sub>16</sub>
	<b>ACW1834</b>	17 <sup>9</sup> / <sub>32</sub> x 37 <sup>9</sup> / <sub>32</sub>	12 <sup>5</sup> / <sub>8</sub> x 31 <sup>13</sup> / <sub>16</sub>
	<b>ACW1838</b>	17 <sup>9</sup> / <sub>32</sub> x 41 <sup>9</sup> / <sub>32</sub>	12 <sup>5</sup> / <sub>8</sub> x 35 <sup>13</sup> / <sub>16</sub>
	<b>ACW1840</b>	17 <sup>9</sup> / <sub>32</sub> x 45 <sup>9</sup> / <sub>32</sub>	12 <sup>5</sup> / <sub>8</sub> x 39 <sup>13</sup> / <sub>16</sub>
	<b>ACW1844</b>	17 <sup>9</sup> / <sub>32</sub> x 49 <sup>9</sup> / <sub>32</sub>	12 <sup>5</sup> / <sub>8</sub> x 43 <sup>13</sup> / <sub>16</sub>
	<b>ACW1848</b>	17 <sup>9</sup> / <sub>32</sub> x 53 <sup>9</sup> / <sub>32</sub>	12 <sup>5</sup> / <sub>8</sub> x 47 <sup>13</sup> / <sub>16</sub>
	<b>ACW1850</b>	17 <sup>9</sup> / <sub>32</sub> x 57 <sup>9</sup> / <sub>32</sub>	12 <sup>5</sup> / <sub>8</sub> x 51 <sup>13</sup> / <sub>16</sub>
	<b>ACW1854</b>	17 <sup>9</sup> / <sub>32</sub> x 61 <sup>9</sup> / <sub>32</sub>	12 <sup>5</sup> / <sub>8</sub> x 55 <sup>13</sup> / <sub>16</sub>
	<b>ACW1858</b>	17 <sup>9</sup> / <sub>32</sub> x 65 <sup>9</sup> / <sub>32</sub>	12 <sup>5</sup> / <sub>8</sub> x 59 <sup>13</sup> / <sub>16</sub>
	<b>ACW1860</b>	17 <sup>9</sup> / <sub>32</sub> x 69 <sup>9</sup> / <sub>32</sub>	12 <sup>5</sup> / <sub>8</sub> x 63 <sup>13</sup> / <sub>16</sub>
	<b>ACW1864</b>	17 <sup>9</sup> / <sub>32</sub> x 73 <sup>9</sup> / <sub>32</sub>	12 <sup>5</sup> / <sub>8</sub> x 67 <sup>13</sup> / <sub>16</sub>
	<b>ACW1868</b>	17 <sup>9</sup> / <sub>32</sub> x 77 <sup>9</sup> / <sub>32</sub>	12 <sup>5</sup> / <sub>8</sub> x 71 <sup>13</sup> / <sub>16</sub>
	<b>ACW1870</b>	17 <sup>9</sup> / <sub>32</sub> x 81 <sup>9</sup> / <sub>32</sub>	12 <sup>5</sup> / <sub>8</sub> x 75 <sup>13</sup> / <sub>16</sub>
	<b>ACW1874</b>	17 <sup>9</sup> / <sub>32</sub> x 85 <sup>9</sup> / <sub>32</sub>	12 <sup>5</sup> / <sub>8</sub> x 79 <sup>13</sup> / <sub>16</sub>
<b>ACW1878</b>	17 <sup>9</sup> / <sub>32</sub> x 89 <sup>9</sup> / <sub>32</sub>	12 <sup>5</sup> / <sub>8</sub> x 83 <sup>13</sup> / <sub>16</sub>	
<b>ACW1880</b>	17 <sup>9</sup> / <sub>32</sub> x 93 <sup>9</sup> / <sub>32</sub>	12 <sup>5</sup> / <sub>8</sub> x 87 <sup>13</sup> / <sub>16</sub>	

## Sash

Sash Size Table - Standard Windows			
Unit No.	Overall Sash (w x h)	Unobstructed Glass (w x h)	
<b>20</b>	<b>ACW2020</b>	21 <sup>9</sup> / <sub>32</sub> X 21 <sup>9</sup> / <sub>32</sub>	16 <sup>5</sup> / <sub>8</sub> X 15 <sup>13</sup> / <sub>16</sub>
	<b>ACW2024</b>	21 <sup>9</sup> / <sub>32</sub> X 25 <sup>9</sup> / <sub>32</sub>	16 <sup>5</sup> / <sub>8</sub> X 19 <sup>13</sup> / <sub>16</sub>
	<b>ACW2028</b>	21 <sup>9</sup> / <sub>32</sub> X 29 <sup>9</sup> / <sub>32</sub>	16 <sup>5</sup> / <sub>8</sub> X 23 <sup>13</sup> / <sub>16</sub>
	<b>ACW2030</b>	21 <sup>9</sup> / <sub>32</sub> X 33 <sup>9</sup> / <sub>32</sub>	16 <sup>5</sup> / <sub>8</sub> X 27 <sup>13</sup> / <sub>16</sub>
	<b>ACW2034</b>	21 <sup>9</sup> / <sub>32</sub> X 37 <sup>9</sup> / <sub>32</sub>	16 <sup>5</sup> / <sub>8</sub> X 31 <sup>13</sup> / <sub>16</sub>
	<b>ACW2038</b>	21 <sup>9</sup> / <sub>32</sub> X 41 <sup>9</sup> / <sub>32</sub>	16 <sup>5</sup> / <sub>8</sub> X 35 <sup>13</sup> / <sub>16</sub>
	<b>ACW2040</b>	21 <sup>9</sup> / <sub>32</sub> X 45 <sup>9</sup> / <sub>32</sub>	16 <sup>5</sup> / <sub>8</sub> X 39 <sup>13</sup> / <sub>16</sub>
	<b>ACW2044</b>	21 <sup>9</sup> / <sub>32</sub> X 49 <sup>9</sup> / <sub>32</sub>	16 <sup>5</sup> / <sub>8</sub> X 43 <sup>13</sup> / <sub>16</sub>
	<b>ACW2048</b>	21 <sup>9</sup> / <sub>32</sub> X 53 <sup>9</sup> / <sub>32</sub>	16 <sup>5</sup> / <sub>8</sub> X 47 <sup>13</sup> / <sub>16</sub>
	<b>ACW2050</b>	21 <sup>9</sup> / <sub>32</sub> X 57 <sup>9</sup> / <sub>32</sub>	16 <sup>5</sup> / <sub>8</sub> X 51 <sup>13</sup> / <sub>16</sub>
	<b>ACW2054</b>	21 <sup>9</sup> / <sub>32</sub> X 61 <sup>9</sup> / <sub>32</sub>	16 <sup>5</sup> / <sub>8</sub> X 55 <sup>13</sup> / <sub>16</sub>
	<b>ACW2058</b>	21 <sup>9</sup> / <sub>32</sub> X 65 <sup>9</sup> / <sub>32</sub>	16 <sup>5</sup> / <sub>8</sub> X 59 <sup>13</sup> / <sub>16</sub>
	<b>ACW2060</b>	21 <sup>9</sup> / <sub>32</sub> X 69 <sup>9</sup> / <sub>32</sub>	16 <sup>5</sup> / <sub>8</sub> X 63 <sup>13</sup> / <sub>16</sub>
	<b>ACW2064</b>	21 <sup>9</sup> / <sub>32</sub> X 73 <sup>9</sup> / <sub>32</sub>	16 <sup>5</sup> / <sub>8</sub> X 67 <sup>13</sup> / <sub>16</sub>
	<b>ACW2068</b>	21 <sup>9</sup> / <sub>32</sub> X 77 <sup>9</sup> / <sub>32</sub>	16 <sup>5</sup> / <sub>8</sub> X 71 <sup>13</sup> / <sub>16</sub>
	<b>ACW2070</b>	21 <sup>9</sup> / <sub>32</sub> X 81 <sup>9</sup> / <sub>32</sub>	16 <sup>5</sup> / <sub>8</sub> X 75 <sup>13</sup> / <sub>16</sub>
<b>ACW2074</b>	21 <sup>9</sup> / <sub>32</sub> X 85 <sup>9</sup> / <sub>32</sub>	16 <sup>5</sup> / <sub>8</sub> X 79 <sup>13</sup> / <sub>16</sub>	
<b>ACW2078</b>	21 <sup>9</sup> / <sub>32</sub> X 89 <sup>9</sup> / <sub>32</sub>	16 <sup>5</sup> / <sub>8</sub> X 83 <sup>13</sup> / <sub>16</sub>	
<b>ACW2080</b>	21 <sup>9</sup> / <sub>32</sub> X 93 <sup>9</sup> / <sub>32</sub>	16 <sup>5</sup> / <sub>8</sub> X 87 <sup>13</sup> / <sub>16</sub>	

# A-Series Casement & Picture Windows (2008 to Present)

Standard, Transom and Picture Windows

## Sash

Sash Size Table - Standard Windows			
Unit No.	Overall Sash (w x h)	Unobstructed Glass (w x h)	
<b>24</b>	<b>ACW2420</b>	25 <sup>9</sup> / <sub>32</sub> X 21 <sup>9</sup> / <sub>32</sub>	20 <sup>5</sup> / <sub>8</sub> X 15 <sup>13</sup> / <sub>16</sub>
	<b>ACW2424</b>	25 <sup>9</sup> / <sub>32</sub> X 25 <sup>9</sup> / <sub>32</sub>	20 <sup>5</sup> / <sub>8</sub> X 19 <sup>13</sup> / <sub>16</sub>
	<b>ACW2428</b>	25 <sup>9</sup> / <sub>32</sub> X 29 <sup>9</sup> / <sub>32</sub>	20 <sup>5</sup> / <sub>8</sub> X 23 <sup>13</sup> / <sub>16</sub>
	<b>ACW2430</b>	25 <sup>9</sup> / <sub>32</sub> X 33 <sup>9</sup> / <sub>32</sub>	20 <sup>5</sup> / <sub>8</sub> X 27 <sup>13</sup> / <sub>16</sub>
	<b>ACW2434</b>	25 <sup>9</sup> / <sub>32</sub> X 37 <sup>9</sup> / <sub>32</sub>	20 <sup>5</sup> / <sub>8</sub> X 31 <sup>13</sup> / <sub>16</sub>
	<b>ACW2438</b>	25 <sup>9</sup> / <sub>32</sub> X 41 <sup>9</sup> / <sub>32</sub>	20 <sup>5</sup> / <sub>8</sub> X 35 <sup>13</sup> / <sub>16</sub>
	<b>ACW2440</b>	25 <sup>9</sup> / <sub>32</sub> X 45 <sup>9</sup> / <sub>32</sub>	20 <sup>5</sup> / <sub>8</sub> X 39 <sup>13</sup> / <sub>16</sub>
	<b>ACW2444</b>	25 <sup>9</sup> / <sub>32</sub> X 49 <sup>9</sup> / <sub>32</sub>	20 <sup>5</sup> / <sub>8</sub> X 43 <sup>13</sup> / <sub>16</sub>
	<b>ACW2448</b>	25 <sup>9</sup> / <sub>32</sub> X 53 <sup>9</sup> / <sub>32</sub>	20 <sup>5</sup> / <sub>8</sub> X 47 <sup>13</sup> / <sub>16</sub>
	<b>ACW2450</b>	25 <sup>9</sup> / <sub>32</sub> X 57 <sup>9</sup> / <sub>32</sub>	20 <sup>5</sup> / <sub>8</sub> X 51 <sup>13</sup> / <sub>16</sub>
	<b>ACW2454</b>	25 <sup>9</sup> / <sub>32</sub> X 61 <sup>9</sup> / <sub>32</sub>	20 <sup>5</sup> / <sub>8</sub> X 55 <sup>13</sup> / <sub>16</sub>
	<b>ACW2458</b>	25 <sup>9</sup> / <sub>32</sub> X 65 <sup>9</sup> / <sub>32</sub>	20 <sup>5</sup> / <sub>8</sub> X 59 <sup>13</sup> / <sub>16</sub>
	<b>ACW2460</b>	25 <sup>9</sup> / <sub>32</sub> X 69 <sup>9</sup> / <sub>32</sub>	20 <sup>5</sup> / <sub>8</sub> X 63 <sup>13</sup> / <sub>16</sub>
	<b>ACW2464</b>	25 <sup>9</sup> / <sub>32</sub> X 73 <sup>9</sup> / <sub>32</sub>	20 <sup>5</sup> / <sub>8</sub> X 67 <sup>13</sup> / <sub>16</sub>
	<b>ACW2468</b>	25 <sup>9</sup> / <sub>32</sub> X 77 <sup>9</sup> / <sub>32</sub>	20 <sup>5</sup> / <sub>8</sub> X 71 <sup>13</sup> / <sub>16</sub>
	<b>ACW2470</b>	25 <sup>9</sup> / <sub>32</sub> X 81 <sup>9</sup> / <sub>32</sub>	20 <sup>5</sup> / <sub>8</sub> X 75 <sup>13</sup> / <sub>16</sub>
	<b>ACW2474</b>	25 <sup>9</sup> / <sub>32</sub> X 85 <sup>9</sup> / <sub>32</sub>	20 <sup>5</sup> / <sub>8</sub> X 79 <sup>13</sup> / <sub>16</sub>
<b>ACW2478</b>	25 <sup>9</sup> / <sub>32</sub> X 89 <sup>9</sup> / <sub>32</sub>	20 <sup>5</sup> / <sub>8</sub> X 83 <sup>13</sup> / <sub>16</sub>	
<b>ACW2480</b>	25 <sup>9</sup> / <sub>32</sub> X 93 <sup>9</sup> / <sub>32</sub>	20 <sup>5</sup> / <sub>8</sub> X 87 <sup>13</sup> / <sub>16</sub>	

## Sash

Sash Size Table - Standard Windows			
Unit No.	Overall Sash (w x h)	Unobstructed Glass (w x h)	
26	ACW2624	27 <sup>9</sup> / <sub>32</sub> X 25 <sup>9</sup> / <sub>32</sub>	22 <sup>5</sup> / <sub>8</sub> X 19 <sup>13</sup> / <sub>16</sub>
	ACW2628	27 <sup>9</sup> / <sub>32</sub> X 29 <sup>9</sup> / <sub>32</sub>	22 <sup>5</sup> / <sub>8</sub> X 23 <sup>13</sup> / <sub>16</sub>
	ACW2630	27 <sup>9</sup> / <sub>32</sub> X 33 <sup>9</sup> / <sub>32</sub>	22 <sup>5</sup> / <sub>8</sub> X 27 <sup>13</sup> / <sub>16</sub>
	ACW2634	27 <sup>9</sup> / <sub>32</sub> X 37 <sup>9</sup> / <sub>32</sub>	22 <sup>5</sup> / <sub>8</sub> X 31 <sup>13</sup> / <sub>16</sub>
	ACW2638	27 <sup>9</sup> / <sub>32</sub> X 41 <sup>9</sup> / <sub>32</sub>	22 <sup>5</sup> / <sub>8</sub> X 35 <sup>13</sup> / <sub>16</sub>
	ACW2640	27 <sup>9</sup> / <sub>32</sub> X 45 <sup>9</sup> / <sub>32</sub>	22 <sup>5</sup> / <sub>8</sub> X 39 <sup>13</sup> / <sub>16</sub>
	ACW2644	27 <sup>9</sup> / <sub>32</sub> X 49 <sup>9</sup> / <sub>32</sub>	22 <sup>5</sup> / <sub>8</sub> X 43 <sup>13</sup> / <sub>16</sub>
	ACW2648	27 <sup>9</sup> / <sub>32</sub> X 53 <sup>9</sup> / <sub>32</sub>	22 <sup>5</sup> / <sub>8</sub> X 47 <sup>13</sup> / <sub>16</sub>
	ACW2650	27 <sup>9</sup> / <sub>32</sub> X 57 <sup>9</sup> / <sub>32</sub>	22 <sup>5</sup> / <sub>8</sub> X 51 <sup>13</sup> / <sub>16</sub>
	ACW2654	27 <sup>9</sup> / <sub>32</sub> X 61 <sup>9</sup> / <sub>32</sub>	22 <sup>5</sup> / <sub>8</sub> X 55 <sup>13</sup> / <sub>16</sub>
	ACW2658	27 <sup>9</sup> / <sub>32</sub> X 65 <sup>9</sup> / <sub>32</sub>	22 <sup>5</sup> / <sub>8</sub> X 59 <sup>13</sup> / <sub>16</sub>
	ACW2660	27 <sup>9</sup> / <sub>32</sub> X 69 <sup>9</sup> / <sub>32</sub>	22 <sup>5</sup> / <sub>8</sub> X 63 <sup>13</sup> / <sub>16</sub>
	ACW2664	27 <sup>9</sup> / <sub>32</sub> X 73 <sup>9</sup> / <sub>32</sub>	22 <sup>5</sup> / <sub>8</sub> X 67 <sup>13</sup> / <sub>16</sub>
	ACW2668	27 <sup>9</sup> / <sub>32</sub> X 77 <sup>9</sup> / <sub>32</sub>	22 <sup>5</sup> / <sub>8</sub> X 71 <sup>13</sup> / <sub>16</sub>
	ACW2670	27 <sup>9</sup> / <sub>32</sub> X 81 <sup>9</sup> / <sub>32</sub>	22 <sup>5</sup> / <sub>8</sub> X 75 <sup>13</sup> / <sub>16</sub>
	ACW2674	27 <sup>9</sup> / <sub>32</sub> X 85 <sup>9</sup> / <sub>32</sub>	22 <sup>5</sup> / <sub>8</sub> X 79 <sup>13</sup> / <sub>16</sub>
ACW2678	27 <sup>9</sup> / <sub>32</sub> X 89 <sup>9</sup> / <sub>32</sub>	22 <sup>5</sup> / <sub>8</sub> X 83 <sup>13</sup> / <sub>16</sub>	
ACW2680	27 <sup>9</sup> / <sub>32</sub> X 93 <sup>9</sup> / <sub>32</sub>	22 <sup>5</sup> / <sub>8</sub> X 87 <sup>13</sup> / <sub>16</sub>	

# A-Series Casement & Picture Windows (2008 to Present)

*Standard, Transom and Picture Windows*

## Sash

Sash Size Table - Standard Windows			
Unit No.	Overall Sash (w x h)	Unobstructed Glass (w x h)	
28	<b>ACW2824</b>	29 <sup>9</sup> / <sub>32</sub> X 25 <sup>9</sup> / <sub>32</sub>	24 <sup>5</sup> / <sub>8</sub> X 19 <sup>13</sup> / <sub>16</sub>
	<b>ACW2828</b>	29 <sup>9</sup> / <sub>32</sub> X 29 <sup>9</sup> / <sub>32</sub>	24 <sup>5</sup> / <sub>8</sub> X 23 <sup>13</sup> / <sub>16</sub>
	<b>ACW2830</b>	29 <sup>9</sup> / <sub>32</sub> X 33 <sup>9</sup> / <sub>32</sub>	24 <sup>5</sup> / <sub>8</sub> X 27 <sup>13</sup> / <sub>16</sub>
	<b>ACW2834</b>	29 <sup>9</sup> / <sub>32</sub> X 37 <sup>9</sup> / <sub>32</sub>	24 <sup>5</sup> / <sub>8</sub> X 31 <sup>13</sup> / <sub>16</sub>
	<b>ACW2838</b>	29 <sup>9</sup> / <sub>32</sub> X 41 <sup>9</sup> / <sub>32</sub>	24 <sup>5</sup> / <sub>8</sub> X 35 <sup>13</sup> / <sub>16</sub>
	<b>ACW2840</b>	29 <sup>9</sup> / <sub>32</sub> X 45 <sup>9</sup> / <sub>32</sub>	24 <sup>5</sup> / <sub>8</sub> X 39 <sup>13</sup> / <sub>16</sub>
	<b>ACW2844</b>	29 <sup>9</sup> / <sub>32</sub> X 49 <sup>9</sup> / <sub>32</sub>	24 <sup>5</sup> / <sub>8</sub> X 43 <sup>13</sup> / <sub>16</sub>
	<b>ACW2848</b>	29 <sup>9</sup> / <sub>32</sub> X 53 <sup>9</sup> / <sub>32</sub>	24 <sup>5</sup> / <sub>8</sub> X 47 <sup>13</sup> / <sub>16</sub>
	<b>ACW2850</b>	29 <sup>9</sup> / <sub>32</sub> X 57 <sup>9</sup> / <sub>32</sub>	24 <sup>5</sup> / <sub>8</sub> X 51 <sup>13</sup> / <sub>16</sub>
	<b>ACW2854</b>	29 <sup>9</sup> / <sub>32</sub> X 61 <sup>9</sup> / <sub>32</sub>	24 <sup>5</sup> / <sub>8</sub> X 55 <sup>13</sup> / <sub>16</sub>
	<b>ACW2858</b>	29 <sup>9</sup> / <sub>32</sub> X 65 <sup>9</sup> / <sub>32</sub>	24 <sup>5</sup> / <sub>8</sub> X 59 <sup>13</sup> / <sub>16</sub>
	<b>ACW2860</b>	29 <sup>9</sup> / <sub>32</sub> X 69 <sup>9</sup> / <sub>32</sub>	24 <sup>5</sup> / <sub>8</sub> X 63 <sup>13</sup> / <sub>16</sub>
	<b>ACW2864</b>	29 <sup>9</sup> / <sub>32</sub> X 73 <sup>9</sup> / <sub>32</sub>	24 <sup>5</sup> / <sub>8</sub> X 67 <sup>13</sup> / <sub>16</sub>
	<b>ACW2868</b>	29 <sup>9</sup> / <sub>32</sub> X 77 <sup>9</sup> / <sub>32</sub>	24 <sup>5</sup> / <sub>8</sub> X 71 <sup>13</sup> / <sub>16</sub>
	<b>ACW2870</b>	29 <sup>9</sup> / <sub>32</sub> X 81 <sup>9</sup> / <sub>32</sub>	24 <sup>5</sup> / <sub>8</sub> X 75 <sup>13</sup> / <sub>16</sub>
	<b>ACW2874</b>	29 <sup>9</sup> / <sub>32</sub> X 85 <sup>9</sup> / <sub>32</sub>	24 <sup>5</sup> / <sub>8</sub> X 79 <sup>13</sup> / <sub>16</sub>
<b>ACW2878</b>	29 <sup>9</sup> / <sub>32</sub> X 89 <sup>9</sup> / <sub>32</sub>	24 <sup>5</sup> / <sub>8</sub> X 83 <sup>13</sup> / <sub>16</sub>	
<b>ACW2880</b>	29 <sup>9</sup> / <sub>32</sub> X 93 <sup>9</sup> / <sub>32</sub>	24 <sup>5</sup> / <sub>8</sub> X 87 <sup>13</sup> / <sub>16</sub>	
210	<b>ACW21028</b>	31 <sup>9</sup> / <sub>32</sub> X 29 <sup>9</sup> / <sub>32</sub>	26 <sup>5</sup> / <sub>8</sub> X 23 <sup>13</sup> / <sub>16</sub>
	<b>ACW21030</b>	31 <sup>9</sup> / <sub>32</sub> X 33 <sup>9</sup> / <sub>32</sub>	26 <sup>5</sup> / <sub>8</sub> X 27 <sup>13</sup> / <sub>16</sub>
	<b>ACW21034</b>	31 <sup>9</sup> / <sub>32</sub> X 37 <sup>9</sup> / <sub>32</sub>	26 <sup>5</sup> / <sub>8</sub> X 31 <sup>13</sup> / <sub>16</sub>
	<b>ACW21038</b>	31 <sup>9</sup> / <sub>32</sub> X 41 <sup>9</sup> / <sub>32</sub>	26 <sup>5</sup> / <sub>8</sub> X 35 <sup>13</sup> / <sub>16</sub>
	<b>ACW21040</b>	31 <sup>9</sup> / <sub>32</sub> X 45 <sup>9</sup> / <sub>32</sub>	26 <sup>5</sup> / <sub>8</sub> X 39 <sup>13</sup> / <sub>16</sub>
	<b>ACW21044</b>	31 <sup>9</sup> / <sub>32</sub> X 49 <sup>9</sup> / <sub>32</sub>	26 <sup>5</sup> / <sub>8</sub> X 43 <sup>13</sup> / <sub>16</sub>
	<b>ACW21048</b>	31 <sup>9</sup> / <sub>32</sub> X 53 <sup>9</sup> / <sub>32</sub>	26 <sup>5</sup> / <sub>8</sub> X 47 <sup>13</sup> / <sub>16</sub>
	<b>ACW21050</b>	31 <sup>9</sup> / <sub>32</sub> X 57 <sup>9</sup> / <sub>32</sub>	26 <sup>5</sup> / <sub>8</sub> X 51 <sup>13</sup> / <sub>16</sub>
	<b>ACW21054</b>	31 <sup>9</sup> / <sub>32</sub> X 61 <sup>9</sup> / <sub>32</sub>	26 <sup>5</sup> / <sub>8</sub> X 55 <sup>13</sup> / <sub>16</sub>
	<b>ACW21058</b>	31 <sup>9</sup> / <sub>32</sub> X 65 <sup>9</sup> / <sub>32</sub>	26 <sup>5</sup> / <sub>8</sub> X 59 <sup>13</sup> / <sub>16</sub>
	<b>ACW21060</b>	31 <sup>9</sup> / <sub>32</sub> X 69 <sup>9</sup> / <sub>32</sub>	26 <sup>5</sup> / <sub>8</sub> X 63 <sup>13</sup> / <sub>16</sub>
	<b>ACW21064</b>	31 <sup>9</sup> / <sub>32</sub> X 73 <sup>9</sup> / <sub>32</sub>	26 <sup>5</sup> / <sub>8</sub> X 67 <sup>13</sup> / <sub>16</sub>
	<b>ACW21068</b>	31 <sup>9</sup> / <sub>32</sub> X 77 <sup>9</sup> / <sub>32</sub>	26 <sup>5</sup> / <sub>8</sub> X 71 <sup>13</sup> / <sub>16</sub>
	<b>ACW21070</b>	31 <sup>9</sup> / <sub>32</sub> X 81 <sup>9</sup> / <sub>32</sub>	26 <sup>5</sup> / <sub>8</sub> X 75 <sup>13</sup> / <sub>16</sub>
	<b>ACW21074</b>	31 <sup>9</sup> / <sub>32</sub> X 85 <sup>9</sup> / <sub>32</sub>	26 <sup>5</sup> / <sub>8</sub> X 79 <sup>13</sup> / <sub>16</sub>
	<b>ACW21078</b>	31 <sup>9</sup> / <sub>32</sub> X 89 <sup>9</sup> / <sub>32</sub>	26 <sup>5</sup> / <sub>8</sub> X 83 <sup>13</sup> / <sub>16</sub>
<b>ACW21080</b>	31 <sup>9</sup> / <sub>32</sub> X 93 <sup>9</sup> / <sub>32</sub>	26 <sup>5</sup> / <sub>8</sub> X 87 <sup>13</sup> / <sub>16</sub>	

## Sash

Sash Size Table - Standard Windows			
Unit No.	Overall Sash (w x h)	Unobstructed Glass (w x h)	
<b>30</b>	<b>ACW3028</b>	33 <sup>9</sup> / <sub>32</sub> X 29 <sup>9</sup> / <sub>32</sub>	28 <sup>5</sup> / <sub>8</sub> X 23 <sup>13</sup> / <sub>16</sub>
	<b>ACW3030</b>	33 <sup>9</sup> / <sub>32</sub> X 33 <sup>9</sup> / <sub>32</sub>	28 <sup>5</sup> / <sub>8</sub> X 27 <sup>13</sup> / <sub>16</sub>
	<b>ACW3034</b>	33 <sup>9</sup> / <sub>32</sub> X 37 <sup>9</sup> / <sub>32</sub>	28 <sup>5</sup> / <sub>8</sub> X 31 <sup>13</sup> / <sub>16</sub>
	<b>ACW3038</b>	33 <sup>9</sup> / <sub>32</sub> X 41 <sup>9</sup> / <sub>32</sub>	28 <sup>5</sup> / <sub>8</sub> X 35 <sup>13</sup> / <sub>16</sub>
	<b>ACW3040</b>	33 <sup>9</sup> / <sub>32</sub> X 45 <sup>9</sup> / <sub>32</sub>	28 <sup>5</sup> / <sub>8</sub> X 39 <sup>13</sup> / <sub>16</sub>
	<b>ACW3044</b>	33 <sup>9</sup> / <sub>32</sub> X 49 <sup>9</sup> / <sub>32</sub>	28 <sup>5</sup> / <sub>8</sub> X 43 <sup>13</sup> / <sub>16</sub>
	<b>ACW3048</b>	33 <sup>9</sup> / <sub>32</sub> X 53 <sup>9</sup> / <sub>32</sub>	28 <sup>5</sup> / <sub>8</sub> X 47 <sup>13</sup> / <sub>16</sub>
	<b>ACW3050</b>	33 <sup>9</sup> / <sub>32</sub> X 57 <sup>9</sup> / <sub>32</sub>	28 <sup>5</sup> / <sub>8</sub> X 51 <sup>13</sup> / <sub>16</sub>
	<b>ACW3054</b>	33 <sup>9</sup> / <sub>32</sub> X 61 <sup>9</sup> / <sub>32</sub>	28 <sup>5</sup> / <sub>8</sub> X 55 <sup>13</sup> / <sub>16</sub>
	<b>ACW3058</b>	33 <sup>9</sup> / <sub>32</sub> X 65 <sup>9</sup> / <sub>32</sub>	28 <sup>5</sup> / <sub>8</sub> X 59 <sup>13</sup> / <sub>16</sub>
	<b>ACW3060</b>	33 <sup>9</sup> / <sub>32</sub> X 69 <sup>9</sup> / <sub>32</sub>	28 <sup>5</sup> / <sub>8</sub> X 63 <sup>13</sup> / <sub>16</sub>
	<b>ACW3064</b>	33 <sup>9</sup> / <sub>32</sub> X 73 <sup>9</sup> / <sub>32</sub>	28 <sup>5</sup> / <sub>8</sub> X 67 <sup>13</sup> / <sub>16</sub>
	<b>ACW3068</b>	33 <sup>9</sup> / <sub>32</sub> X 77 <sup>9</sup> / <sub>32</sub>	28 <sup>5</sup> / <sub>8</sub> X 71 <sup>13</sup> / <sub>16</sub>
	<b>ACW3070</b>	33 <sup>9</sup> / <sub>32</sub> X 81 <sup>9</sup> / <sub>32</sub>	28 <sup>5</sup> / <sub>8</sub> X 75 <sup>13</sup> / <sub>16</sub>
	<b>ACW3074</b>	33 <sup>9</sup> / <sub>32</sub> X 85 <sup>9</sup> / <sub>32</sub>	28 <sup>5</sup> / <sub>8</sub> X 79 <sup>13</sup> / <sub>16</sub>
<b>ACW3078</b>	33 <sup>9</sup> / <sub>32</sub> X 89 <sup>9</sup> / <sub>32</sub>	28 <sup>5</sup> / <sub>8</sub> X 83 <sup>13</sup> / <sub>16</sub>	
<b>ACW3080</b>	33 <sup>9</sup> / <sub>32</sub> X 93 <sup>9</sup> / <sub>32</sub>	28 <sup>5</sup> / <sub>8</sub> X 87 <sup>13</sup> / <sub>16</sub>	
<b>32</b>	<b>ACW3230</b>	35 <sup>9</sup> / <sub>32</sub> X 33 <sup>9</sup> / <sub>32</sub>	30 <sup>5</sup> / <sub>8</sub> X 27 <sup>13</sup> / <sub>16</sub>
	<b>ACW3234</b>	35 <sup>9</sup> / <sub>32</sub> X 37 <sup>9</sup> / <sub>32</sub>	30 <sup>5</sup> / <sub>8</sub> X 31 <sup>13</sup> / <sub>16</sub>
	<b>ACW3238</b>	35 <sup>9</sup> / <sub>32</sub> X 41 <sup>9</sup> / <sub>32</sub>	30 <sup>5</sup> / <sub>8</sub> X 35 <sup>13</sup> / <sub>16</sub>
	<b>ACW3240</b>	35 <sup>9</sup> / <sub>32</sub> X 45 <sup>9</sup> / <sub>32</sub>	30 <sup>5</sup> / <sub>8</sub> X 39 <sup>13</sup> / <sub>16</sub>
	<b>ACW3244</b>	35 <sup>9</sup> / <sub>32</sub> X 49 <sup>9</sup> / <sub>32</sub>	30 <sup>5</sup> / <sub>8</sub> X 43 <sup>13</sup> / <sub>16</sub>
	<b>ACW3248</b>	35 <sup>9</sup> / <sub>32</sub> X 53 <sup>9</sup> / <sub>32</sub>	30 <sup>5</sup> / <sub>8</sub> X 47 <sup>13</sup> / <sub>16</sub>
	<b>ACW3250</b>	35 <sup>9</sup> / <sub>32</sub> X 57 <sup>9</sup> / <sub>32</sub>	30 <sup>5</sup> / <sub>8</sub> X 51 <sup>13</sup> / <sub>16</sub>
	<b>ACW3254</b>	35 <sup>9</sup> / <sub>32</sub> X 61 <sup>9</sup> / <sub>32</sub>	30 <sup>5</sup> / <sub>8</sub> X 55 <sup>13</sup> / <sub>16</sub>
	<b>ACW3258</b>	35 <sup>9</sup> / <sub>32</sub> X 65 <sup>9</sup> / <sub>32</sub>	30 <sup>5</sup> / <sub>8</sub> X 59 <sup>13</sup> / <sub>16</sub>
	<b>ACW3260</b>	35 <sup>9</sup> / <sub>32</sub> X 69 <sup>9</sup> / <sub>32</sub>	30 <sup>5</sup> / <sub>8</sub> X 63 <sup>13</sup> / <sub>16</sub>
	<b>ACW3264</b>	35 <sup>9</sup> / <sub>32</sub> X 73 <sup>9</sup> / <sub>32</sub>	30 <sup>5</sup> / <sub>8</sub> X 67 <sup>13</sup> / <sub>16</sub>
	<b>ACW3268</b>	35 <sup>9</sup> / <sub>32</sub> X 77 <sup>9</sup> / <sub>32</sub>	30 <sup>5</sup> / <sub>8</sub> X 71 <sup>13</sup> / <sub>16</sub>
	<b>ACW3270</b>	35 <sup>9</sup> / <sub>32</sub> X 81 <sup>9</sup> / <sub>32</sub>	30 <sup>5</sup> / <sub>8</sub> X 75 <sup>13</sup> / <sub>16</sub>
	<b>ACW3274</b>	35 <sup>9</sup> / <sub>32</sub> X 85 <sup>9</sup> / <sub>32</sub>	30 <sup>5</sup> / <sub>8</sub> X 79 <sup>13</sup> / <sub>16</sub>
	<b>ACW3278</b>	35 <sup>9</sup> / <sub>32</sub> X 89 <sup>9</sup> / <sub>32</sub>	30 <sup>5</sup> / <sub>8</sub> X 83 <sup>13</sup> / <sub>16</sub>
<b>ACW3280</b>	35 <sup>9</sup> / <sub>32</sub> X 93 <sup>9</sup> / <sub>32</sub>	30 <sup>5</sup> / <sub>8</sub> X 87 <sup>13</sup> / <sub>16</sub>	



# A-Series Casement & Picture Windows (2008 to Present)

*Standard, Transom and Picture Windows*

## Sash

Sash Size Table - Standard Windows			
Unit No.	Overall Sash (w x h)	Unobstructed Glass (w x h)	
34	<b>ACW3430</b>	$37 \frac{9}{32} \times 33 \frac{9}{32}$	$32 \frac{5}{8} \times 27 \frac{13}{16}$
	<b>ACW3434</b>	$37 \frac{9}{32} \times 37 \frac{9}{32}$	$32 \frac{5}{8} \times 31 \frac{13}{16}$
	<b>ACW3438</b>	$37 \frac{9}{32} \times 41 \frac{9}{32}$	$32 \frac{5}{8} \times 35 \frac{13}{16}$
	<b>ACW3440</b>	$37 \frac{9}{32} \times 45 \frac{9}{32}$	$32 \frac{5}{8} \times 39 \frac{13}{16}$
	<b>ACW3444</b>	$37 \frac{9}{32} \times 49 \frac{9}{32}$	$32 \frac{5}{8} \times 43 \frac{13}{16}$
	<b>ACW3448</b>	$37 \frac{9}{32} \times 53 \frac{9}{32}$	$32 \frac{5}{8} \times 47 \frac{13}{16}$
	<b>ACW3450</b>	$37 \frac{9}{32} \times 57 \frac{9}{32}$	$32 \frac{5}{8} \times 51 \frac{13}{16}$
	<b>ACW3454</b>	$37 \frac{9}{32} \times 61 \frac{9}{32}$	$32 \frac{5}{8} \times 55 \frac{13}{16}$
	<b>ACW3458</b>	$37 \frac{9}{32} \times 65 \frac{9}{32}$	$32 \frac{5}{8} \times 59 \frac{13}{16}$
	<b>ACW3460</b>	$37 \frac{9}{32} \times 69 \frac{9}{32}$	$32 \frac{5}{8} \times 63 \frac{13}{16}$
	<b>ACW3464</b>	$37 \frac{9}{32} \times 73 \frac{9}{32}$	$32 \frac{5}{8} \times 67 \frac{13}{16}$
	<b>ACW3468</b>	$37 \frac{9}{32} \times 77 \frac{9}{32}$	$32 \frac{5}{8} \times 71 \frac{13}{16}$
	<b>ACW3470</b>	$37 \frac{9}{32} \times 81 \frac{9}{32}$	$32 \frac{5}{8} \times 75 \frac{13}{16}$
	<b>ACW3474</b>	$37 \frac{9}{32} \times 85 \frac{9}{32}$	$32 \frac{5}{8} \times 79 \frac{13}{16}$
<b>ACW3478</b>	$37 \frac{9}{32} \times 89 \frac{9}{32}$	$32 \frac{5}{8} \times 83 \frac{13}{16}$	
<b>ACW3480</b>	$37 \frac{9}{32} \times 93 \frac{9}{32}$	$32 \frac{5}{8} \times 87 \frac{13}{16}$	
36	<b>ACW3634</b>	$39 \frac{9}{32} \times 37 \frac{9}{32}$	$34 \frac{5}{8} \times 31 \frac{13}{16}$
	<b>ACW3638</b>	$39 \frac{9}{32} \times 41 \frac{9}{32}$	$34 \frac{5}{8} \times 35 \frac{13}{16}$
	<b>ACW3640</b>	$39 \frac{9}{32} \times 45 \frac{9}{32}$	$34 \frac{5}{8} \times 39 \frac{13}{16}$
	<b>ACW3644</b>	$39 \frac{9}{32} \times 49 \frac{9}{32}$	$34 \frac{5}{8} \times 43 \frac{13}{16}$
	<b>ACW3648</b>	$39 \frac{9}{32} \times 53 \frac{9}{32}$	$34 \frac{5}{8} \times 47 \frac{13}{16}$
	<b>ACW3650</b>	$39 \frac{9}{32} \times 57 \frac{9}{32}$	$34 \frac{5}{8} \times 51 \frac{13}{16}$
	<b>ACW3654</b>	$39 \frac{9}{32} \times 61 \frac{9}{32}$	$34 \frac{5}{8} \times 55 \frac{13}{16}$
	<b>ACW3658</b>	$39 \frac{9}{32} \times 65 \frac{9}{32}$	$34 \frac{5}{8} \times 59 \frac{13}{16}$
	<b>ACW3660</b>	$39 \frac{9}{32} \times 69 \frac{9}{32}$	$34 \frac{5}{8} \times 63 \frac{13}{16}$
	<b>ACW3664</b>	$39 \frac{9}{32} \times 73 \frac{9}{32}$	$34 \frac{5}{8} \times 67 \frac{13}{16}$
	<b>ACW3668</b>	$39 \frac{9}{32} \times 77 \frac{9}{32}$	$34 \frac{5}{8} \times 71 \frac{13}{16}$
	<b>ACW3670</b>	$39 \frac{9}{32} \times 81 \frac{9}{32}$	$34 \frac{5}{8} \times 75 \frac{13}{16}$
	<b>ACW3674</b>	$39 \frac{9}{32} \times 85 \frac{9}{32}$	$34 \frac{5}{8} \times 79 \frac{13}{16}$
	<b>ACW3678</b>	$39 \frac{9}{32} \times 89 \frac{9}{32}$	$34 \frac{5}{8} \times 83 \frac{13}{16}$
<b>ACW3680</b>	$39 \frac{9}{32} \times 93 \frac{9}{32}$	$34 \frac{5}{8} \times 87 \frac{13}{16}$	

## Sash

Sash Size Table - Standard Windows			
Unit No.	Overall Sash (w x h)	Unobstructed Glass (w x h)	
<b>38</b>	ACW3834	41 <sup>9</sup> / <sub>32</sub> X 37 <sup>9</sup> / <sub>32</sub>	36 <sup>5</sup> / <sub>8</sub> X 31 <sup>13</sup> / <sub>16</sub>
	ACW3838	41 <sup>9</sup> / <sub>32</sub> X 41 <sup>9</sup> / <sub>32</sub>	36 <sup>5</sup> / <sub>8</sub> X 35 <sup>13</sup> / <sub>16</sub>
	ACW3840	41 <sup>9</sup> / <sub>32</sub> X 45 <sup>9</sup> / <sub>32</sub>	36 <sup>5</sup> / <sub>8</sub> X 39 <sup>13</sup> / <sub>16</sub>
	ACW3844	41 <sup>9</sup> / <sub>32</sub> X 49 <sup>9</sup> / <sub>32</sub>	36 <sup>5</sup> / <sub>8</sub> X 43 <sup>13</sup> / <sub>16</sub>
	ACW3848	41 <sup>9</sup> / <sub>32</sub> X 53 <sup>9</sup> / <sub>32</sub>	36 <sup>5</sup> / <sub>8</sub> X 47 <sup>13</sup> / <sub>16</sub>
	ACW3850	41 <sup>9</sup> / <sub>32</sub> X 57 <sup>9</sup> / <sub>32</sub>	36 <sup>5</sup> / <sub>8</sub> X 51 <sup>13</sup> / <sub>16</sub>
	ACW3854	41 <sup>9</sup> / <sub>32</sub> X 61 <sup>9</sup> / <sub>32</sub>	36 <sup>5</sup> / <sub>8</sub> X 55 <sup>13</sup> / <sub>16</sub>
	ACW3858	41 <sup>9</sup> / <sub>32</sub> X 65 <sup>9</sup> / <sub>32</sub>	36 <sup>5</sup> / <sub>8</sub> X 59 <sup>13</sup> / <sub>16</sub>
	ACW3860	41 <sup>9</sup> / <sub>32</sub> X 69 <sup>9</sup> / <sub>32</sub>	36 <sup>5</sup> / <sub>8</sub> X 63 <sup>13</sup> / <sub>16</sub>
	ACW3864	41 <sup>9</sup> / <sub>32</sub> X 73 <sup>9</sup> / <sub>32</sub>	36 <sup>5</sup> / <sub>8</sub> X 67 <sup>13</sup> / <sub>16</sub>
	ACW3868	41 <sup>9</sup> / <sub>32</sub> X 77 <sup>9</sup> / <sub>32</sub>	36 <sup>5</sup> / <sub>8</sub> X 71 <sup>13</sup> / <sub>16</sub>
	ACW3870	41 <sup>9</sup> / <sub>32</sub> X 81 <sup>9</sup> / <sub>32</sub>	36 <sup>5</sup> / <sub>8</sub> X 75 <sup>13</sup> / <sub>16</sub>
	ACW3874	41 <sup>9</sup> / <sub>32</sub> X 85 <sup>9</sup> / <sub>32</sub>	36 <sup>5</sup> / <sub>8</sub> X 79 <sup>13</sup> / <sub>16</sub>
	ACW3878	41 <sup>9</sup> / <sub>32</sub> X 89 <sup>9</sup> / <sub>32</sub>	36 <sup>5</sup> / <sub>8</sub> X 83 <sup>13</sup> / <sub>16</sub>
ACW3880	41 <sup>9</sup> / <sub>32</sub> X 93 <sup>9</sup> / <sub>32</sub>	36 <sup>5</sup> / <sub>8</sub> X 87 <sup>13</sup> / <sub>16</sub>	
<b>310</b>	ACW31038	43 <sup>9</sup> / <sub>32</sub> X 41 <sup>9</sup> / <sub>32</sub>	38 <sup>5</sup> / <sub>8</sub> X 35 <sup>13</sup> / <sub>16</sub>
	ACW31040	43 <sup>9</sup> / <sub>32</sub> X 45 <sup>9</sup> / <sub>32</sub>	38 <sup>5</sup> / <sub>8</sub> X 39 <sup>13</sup> / <sub>16</sub>
	ACW31044	43 <sup>9</sup> / <sub>32</sub> X 49 <sup>9</sup> / <sub>32</sub>	38 <sup>5</sup> / <sub>8</sub> X 43 <sup>13</sup> / <sub>16</sub>
	ACW31048	43 <sup>9</sup> / <sub>32</sub> X 53 <sup>9</sup> / <sub>32</sub>	38 <sup>5</sup> / <sub>8</sub> X 47 <sup>13</sup> / <sub>16</sub>
	ACW31050	43 <sup>9</sup> / <sub>32</sub> X 57 <sup>9</sup> / <sub>32</sub>	38 <sup>5</sup> / <sub>8</sub> X 51 <sup>13</sup> / <sub>16</sub>
	ACW31054	43 <sup>9</sup> / <sub>32</sub> X 61 <sup>9</sup> / <sub>32</sub>	38 <sup>5</sup> / <sub>8</sub> X 55 <sup>13</sup> / <sub>16</sub>
	ACW31058	43 <sup>9</sup> / <sub>32</sub> X 65 <sup>9</sup> / <sub>32</sub>	38 <sup>5</sup> / <sub>8</sub> X 59 <sup>13</sup> / <sub>16</sub>
	ACW31060	43 <sup>9</sup> / <sub>32</sub> X 69 <sup>9</sup> / <sub>32</sub>	38 <sup>5</sup> / <sub>8</sub> X 63 <sup>13</sup> / <sub>16</sub>
	ACW31064	43 <sup>9</sup> / <sub>32</sub> X 73 <sup>9</sup> / <sub>32</sub>	38 <sup>5</sup> / <sub>8</sub> X 67 <sup>13</sup> / <sub>16</sub>
	ACW31068	43 <sup>9</sup> / <sub>32</sub> X 77 <sup>9</sup> / <sub>32</sub>	38 <sup>5</sup> / <sub>8</sub> X 71 <sup>13</sup> / <sub>16</sub>
	ACW31070	43 <sup>9</sup> / <sub>32</sub> X 81 <sup>9</sup> / <sub>32</sub>	38 <sup>5</sup> / <sub>8</sub> X 75 <sup>13</sup> / <sub>16</sub>
	ACW31074	43 <sup>9</sup> / <sub>32</sub> X 85 <sup>9</sup> / <sub>32</sub>	38 <sup>5</sup> / <sub>8</sub> X 79 <sup>13</sup> / <sub>16</sub>
	ACW31078	43 <sup>9</sup> / <sub>32</sub> X 89 <sup>9</sup> / <sub>32</sub>	38 <sup>5</sup> / <sub>8</sub> X 83 <sup>13</sup> / <sub>16</sub>
	ACW31080	43 <sup>9</sup> / <sub>32</sub> X 93 <sup>9</sup> / <sub>32</sub>	38 <sup>5</sup> / <sub>8</sub> X 87 <sup>13</sup> / <sub>16</sub>

# A-Series Casement & Picture Windows (2008 to Present)

Standard, Transom and Picture Windows

## Sash

Sash Size Table - Standard Windows			
Unit No.	Overall Sash (w x h)	Unobstructed Glass (w x h)	
<b>40</b>	<b>ACW4038</b>	45 <sup>9</sup> / <sub>32</sub> X 41 <sup>9</sup> / <sub>32</sub>	40 <sup>5</sup> / <sub>8</sub> X 35 <sup>13</sup> / <sub>16</sub>
	<b>ACW4040</b>	45 <sup>9</sup> / <sub>32</sub> X 45 <sup>9</sup> / <sub>32</sub>	40 <sup>5</sup> / <sub>8</sub> X 39 <sup>13</sup> / <sub>16</sub>
	<b>ACW4044</b>	45 <sup>9</sup> / <sub>32</sub> X 49 <sup>9</sup> / <sub>32</sub>	40 <sup>5</sup> / <sub>8</sub> X 43 <sup>13</sup> / <sub>16</sub>
	<b>ACW4048</b>	45 <sup>9</sup> / <sub>32</sub> X 53 <sup>9</sup> / <sub>32</sub>	40 <sup>5</sup> / <sub>8</sub> X 47 <sup>13</sup> / <sub>16</sub>
	<b>ACW4050</b>	45 <sup>9</sup> / <sub>32</sub> X 57 <sup>9</sup> / <sub>32</sub>	40 <sup>5</sup> / <sub>8</sub> X 51 <sup>13</sup> / <sub>16</sub>
	<b>ACW4054</b>	45 <sup>9</sup> / <sub>32</sub> X 61 <sup>9</sup> / <sub>32</sub>	40 <sup>5</sup> / <sub>8</sub> X 55 <sup>13</sup> / <sub>16</sub>
	<b>ACW4058</b>	45 <sup>9</sup> / <sub>32</sub> X 65 <sup>9</sup> / <sub>32</sub>	40 <sup>5</sup> / <sub>8</sub> X 59 <sup>13</sup> / <sub>16</sub>
	<b>ACW4060</b>	45 <sup>9</sup> / <sub>32</sub> X 69 <sup>9</sup> / <sub>32</sub>	40 <sup>5</sup> / <sub>8</sub> X 63 <sup>13</sup> / <sub>16</sub>
	<b>ACW4064</b>	45 <sup>9</sup> / <sub>32</sub> X 73 <sup>9</sup> / <sub>32</sub>	40 <sup>5</sup> / <sub>8</sub> X 67 <sup>13</sup> / <sub>16</sub>
	<b>ACW4068</b>	45 <sup>9</sup> / <sub>32</sub> X 77 <sup>9</sup> / <sub>32</sub>	40 <sup>5</sup> / <sub>8</sub> X 71 <sup>13</sup> / <sub>16</sub>
	<b>ACW4070</b>	45 <sup>9</sup> / <sub>32</sub> X 81 <sup>9</sup> / <sub>32</sub>	40 <sup>5</sup> / <sub>8</sub> X 75 <sup>13</sup> / <sub>16</sub>
	<b>ACW4074</b>	45 <sup>9</sup> / <sub>32</sub> X 85 <sup>9</sup> / <sub>32</sub>	40 <sup>5</sup> / <sub>8</sub> X 79 <sup>13</sup> / <sub>16</sub>
	<b>ACW4078</b>	45 <sup>9</sup> / <sub>32</sub> X 89 <sup>9</sup> / <sub>32</sub>	40 <sup>5</sup> / <sub>8</sub> X 83 <sup>13</sup> / <sub>16</sub>
	<b>ACW4080</b>	45 <sup>9</sup> / <sub>32</sub> X 93 <sup>9</sup> / <sub>32</sub>	40 <sup>5</sup> / <sub>8</sub> X 87 <sup>13</sup> / <sub>16</sub>

## Sash

### Sash Illustration - Split Arm

**Note:**

See current sash [Product Details](#).

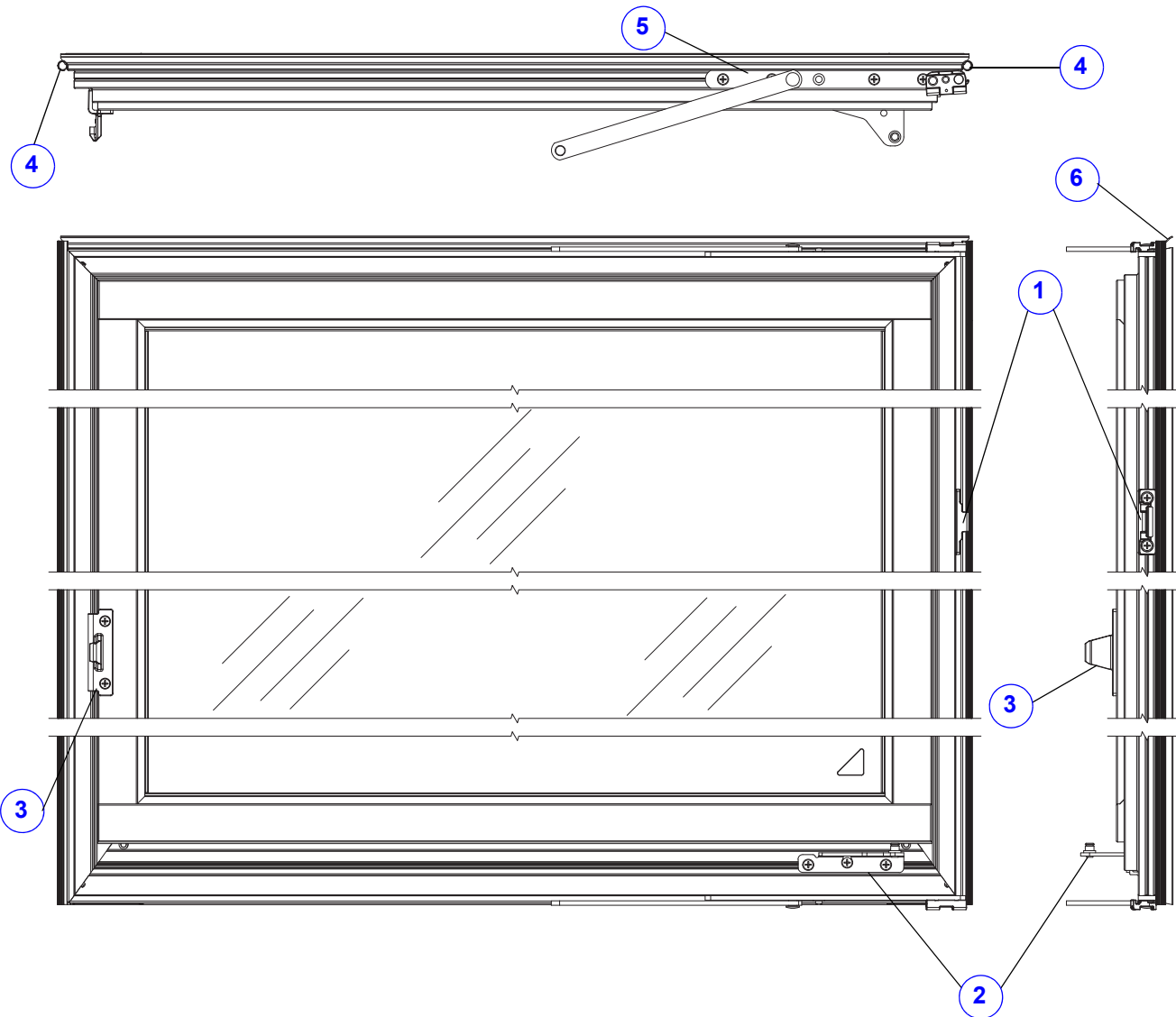

- 1. [Snubber](#)
- 2. [Split Arm Bracket](#)
- 3. [Keeper](#)
- 4. [Bulb Weatherstrip Waterbar](#) (Side)
- 5. [Hinge](#)
- 6. [Leaf Weatherstrip Waterbar](#) (Top)

**Sash w/Split Arm Hardware**

# A-Series Casement & Picture Windows (2008 to Present)

Standard, Transom and Picture Windows

## Sash

### Sash Illustration - Straight Arm

**Note:**

See current sash [Product Details](#).

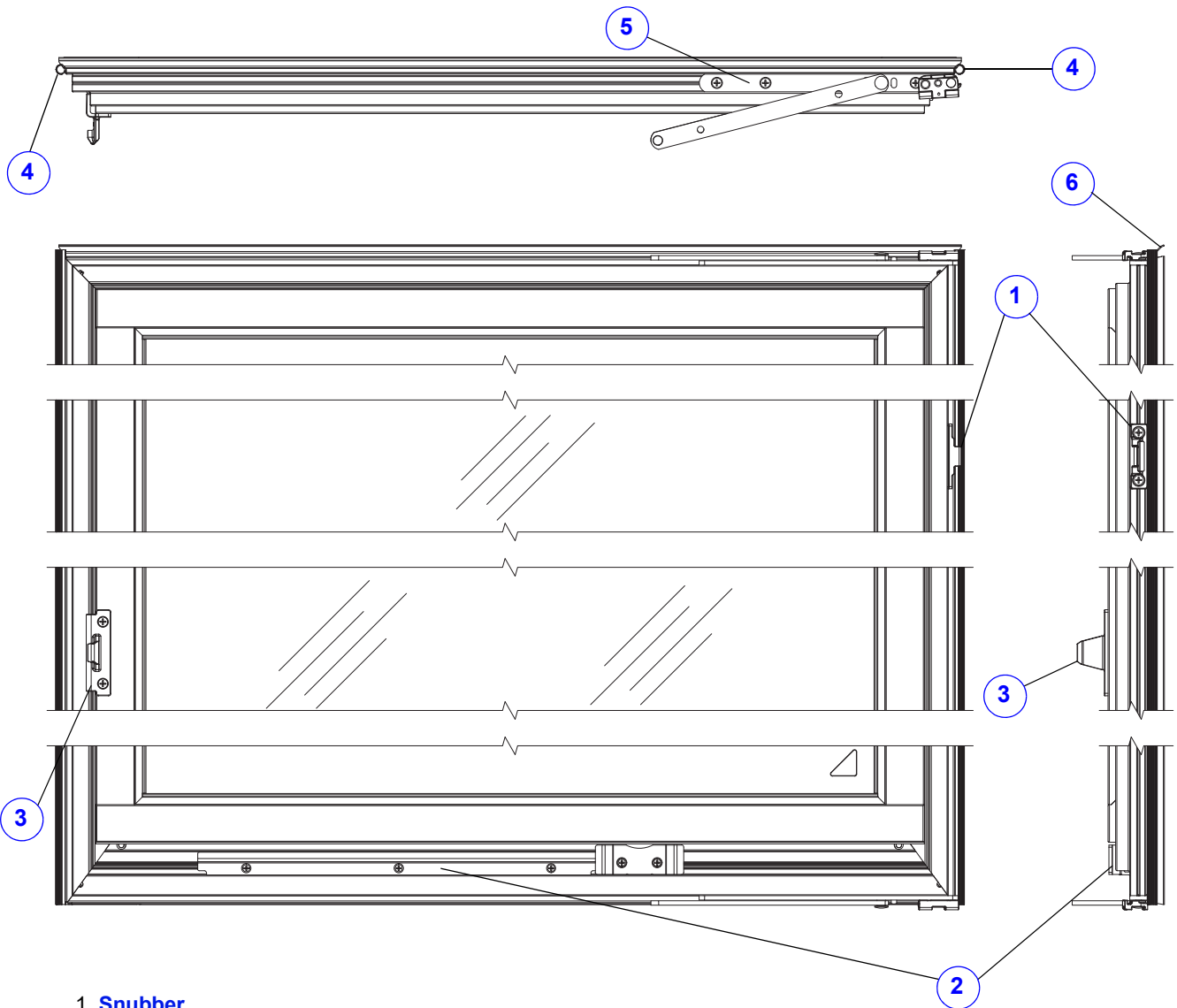

- 1. [Snubber](#)
- 2. [Straight Arm Track](#)
- 3. [Keeper](#)
- 4. [Bulb Weatherstrip Waterbar](#) (Side)
- 5. [Hinge](#)
- 6. [Leaf Weatherstrip Waterbar](#) (Top)

Sash w/Straight Arm Hardware

# Sash

## Sash Options

**Note:**

See [Service Guide 9001738](#) for stationary sash replacement.  
 See [Service Guide 9001740](#) for venting sash with split arm replacement.  
 See [Service Guide 9001739](#) for venting sash with straight arm replacement.  
 See current sash [Product Details](#).

1" glazing uses triple pane glass and art glass only. All other glazing options are 3/4".

### Sash - Standard Window

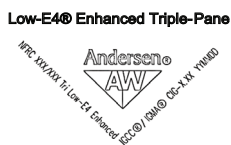

Low-E4® PassiveSun® glass with HeatLock™ technology



TEMPERED  
 16 CFR 1201.11  
 ANSI Z97.1-2009  
 SGGC XXXX  
 CIG-XX Xmm MM/DD/YR  
 CAN/CGSB 12.1-M90

**Exterior color options:**

White	Canvas	Dove Gray
Terratone	Prairie Grass	Red Rock
Sandtone	Cocoa Bean	Black
Forest Green	Dark Bronze	

**Interior species/finish/color options:**

Pine	Maple	Oak	Mahogany
Douglas Fir	Cherry		
Unfinished	Russet	Espresso	Clear Coat
Honey	Cinnamon	Mocha	
White-Painted	Birch Bark	Primed	Sandtone
Canvas	Terratone	Forest Green	Dove Gray
Prairie Grass	Cocoa Bean	Red Rock	Dark Bronze
Black			

**Glass options: (See Logo/Etching examples)**

3/4"		1"
Low-E4®	Low-E4® HeatLock	Low-E4® Triple-Pane
Low-E4® Smart-Sun™	Low-E4® Smart-Sun HeatLock	Low-E4® Smart-Sun Triple-Pane
Low-E4® Passive Sun	Low-E4® Sun Heat-Lock	Low-E4® Enhanced Triple-Pane
Low-E4® Sun	Low-E4® HeatLock Tempered	Low-E4® Smart-Sun Enhanced Triple-Pane
Low-E4® Passive Sun Heatlock	Obscure	Low-E4® Enhanced Triple-Pane Heat-Lock
Low-E4® Tempered	Cascade	Low-E4® Smart-Sun Enhanced Triple-Pane HeatLock
Low-E4® SmartSun Tempered	Reed	Art Glass
Fern		

To order, state:

Product ID (from product label), see [Service Guide 9051877](#)

OR

1. Unit or frame size (ACW XXXX or frame W x H dimensions)
2. Description of part (Sash)
3. Sash handing (Right, Left, or Stationary)
4. Exterior color of sash to be replaced
5. Interior wood species/finish/color of sash to be replaced
6. Glazing type

# A-Series Casement & Picture Windows (2008 to Present)

Standard, Transom and Picture Windows

## Sash

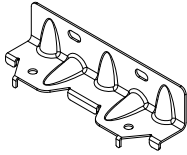
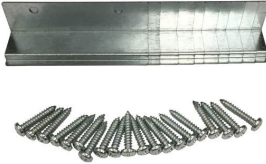
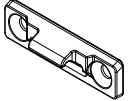
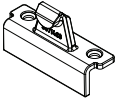
Sash Parts		
<b>Stationary Sash Bracket Kit</b> (October 2012 - Present)		
	<b>Kit Includes:</b> (5) Brackets (20) Screws <a href="#">Service Guide 9001738.</a>	<b>Order No.</b>
		9177141
<b>Stationary Sash Bracket Kit</b> (2008 - September 2012)		
	<b>Kit Includes:</b> (10) Brackets (20) Screws <a href="#">Service Guide 9001738.</a>	<b>Order No.</b>
		9019483
<b>Snubber Kit</b> Ref. No. 1 <a href="#">page 22</a> and <a href="#">page 23</a>		
	<b>Kit Includes:</b> (2) Snubbers (4) Screws	<b>Gray</b>
		9070857
<b>Screw - Snubber</b>		
	<b>Note:</b> #7 X .750, PH FH, 18-8 SS	<b>Order No.</b>
		9003134
<b>Keeper Kit</b>		
	<b>Kit Includes:</b> (1) Keeper (2) Screws  View lock in hardware section <a href="#">page 52.</a>	<b>Gray</b>
		9019485
<b>Screw - Keeper</b>		
	<b>Note:</b> #7 X 1 1/16 XTYPE 17 430 SS	<b>Order No.</b>
		9177142

## Sash

### Weatherstrip

#### Leaf Weatherstrip - Waterbar Ref. No. 6 [page 22](#) and [page 23](#)

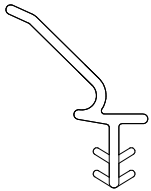

**Note:**

Waterbar is pressure fit. Replacement waterbars are made to order.

*To order, state:*

1. Unit or frame size (ACW xxxx or frame width and height dimension)
2. Description of part (waterbar rail)
3. Color (white, canvas or gray)
4. Product ID (from product label), see [Service Guide 9051877](#).

#### Bulb Weatherstrip - Waterbar / Exterior Ref. No. 4 [page 22](#) and [page 23](#)

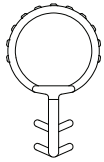

**Note:**

Ships as 8' length. Replaces all vintage side weatherstrip.

Color	Order No.
White	9143805
Canvas	9143806
Gray	9143807



# A-Series Casement & Picture Windows (2008 to Present)

Standard, Transom and Picture Windows

## Glass

### Glass - Picture Windows

**Note:**

Replacement glass for standard and custom-sized picture windows is made to order. Stops may also need to be ordered. See [Service Guide 9001736](#).

### Glass - Picture Window

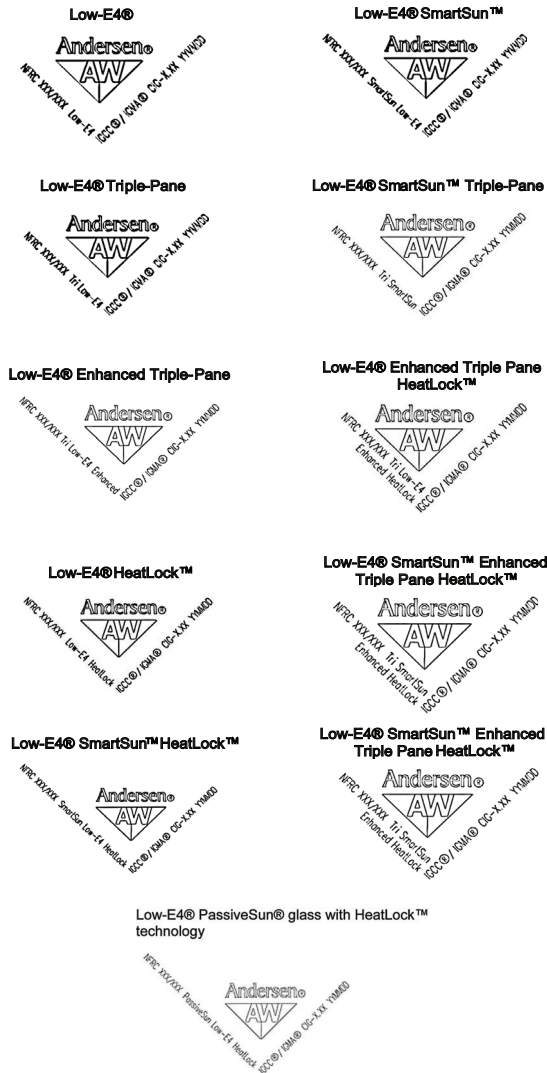

TEMPERED OR  
110°C/120°F  
ANSI Z87.1-2009  
SGCC XXXX  
CIG-XX Xmm MM/DD/YR  
CAN/CGSB 12.1-M9 0

**Glass options:** (See Logo/Etching examples):

	3/4"	1"
Low-E4®	Low-E4® HeatLock	Low-E4® Triple-Pane
Low-E4® Smart-Sun™	Low-E4® Smart-Sun HeatLock	Low-E4® Smart-Sun Triple-Pane
Low-E4® Passive Sun	Low-E4® Sun Heat-Lock	Low-E4® Enhanced Triple-Pane
Low-E4® Sun	Low-E4® HeatLock Tempered	Low-E4® Smart-Sun Enhanced Triple-Pane
Low-E4® Passive Sun Heatlock	Obscure	Low-E4® Enhanced Triple-Pane Heat-Lock
Low-E4® Tempered	Cascade	Low-E4® Smart-Sun Enhanced Triple-Pane HeatLock
Low-E4® SmartSun Tempered	Reed	Art Glass
Fern		

To order, state:

Product ID (from product label), see [Service Guide 9051877](#)

OR

1. Unit or frame size (ACW XXXX or frame W x H dimensions)
2. Description of part (Glass, Glazing Type)

<b>Glass Parts</b>		
<b>Setting Block</b>		
<p><b>Note:</b> Available by description as glass widths can vary. Use the glass label on the unit to order.</p>		
	<b>Dimensions</b>	<b>Order No.</b>
	3/8" x 3/16" x 1-1/2"	OBD

# A-Series Casement & Picture Windows (2008 to Present)

Standard, Transom and Picture Windows

## Insect Screens

### Insect Screens

#### Insect Screen - TruScene® Screens

**Note:**

TruScene® Insect Screens are available in six wood species and six stain colors. Replacement screen for standard and custom sized casement window is made to order.



**Interior Finish Options:**

Pine	Cherry (Not Shown)	Clear Coat	Honey
Oak	Mahogany (Not Shown)	Cinnamon	Russet
Maple	Douglas Fir (Not Shown)	Mocha	Espresso

To order, state:

1. Description of part (TruScene® Insect Screen)
2. Product ID (from product label), see [Service Guide 9051877](#)

#### Insect Screens - Dimensions to Wing Blade

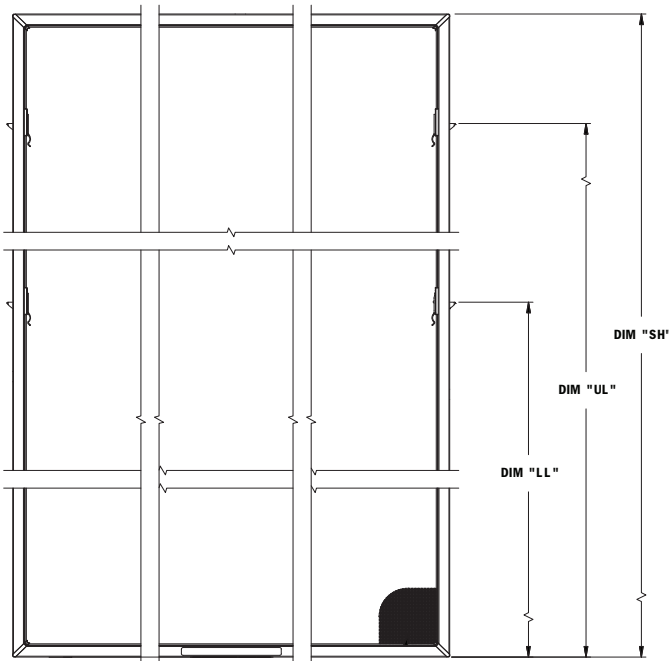

CUSTOM	77.934 AND ABOVE	23.170	SH- 23.142
CUSTOM	65.934 TO 77.933	17.170	SH- 17.142
CUSTOM	57.933 TO 65.933	29.170	NA
CUSTOM	49.933 TO 57.932	23.170	NA
CUSTOM	37.933 TO 49.932	17.170	NA
CUSTOM	UP TO 37.932	10.545	NA
ACWXX80	89.933	23.170	66.791
ACWXX78	85.933	23.170	62.791
ACWXX74	81.933	23.170	58.791
ACWXX70	77.933	17.170	60.791
ACWXX68	73.933	17.170	56.791
ACWXX64	69.933	17.170	52.791
ACWXX60	65.933	29.170	NA
ACWXX58	61.933	29.170	NA
ACWXX54	57.933	29.170	NA
ACWXX50	53.933	23.170	NA
ACWXX48	49.933	23.170	NA
ACWXX44	45.933	17.170	NA
ACWXX40	41.933	17.170	NA
ACWXX38	37.933	17.170	NA
ACWXX34	33.933	10.545	NA
ACWXX30	29.933	10.545	NA
ACWXX28	25.933	10.545	NA
ACWXX24	21.933	10.545	NA
ACWXX20	17.933	10.545	NA
SIZE DES	DIM "SH"	DIM "LL"	DIM "UL"

SCREEN HEIGHT	
ACW40XX	42.902
ACW310XX	40.902
ACW38XX	38.902
ACW36XX	36.902
ACW34XX	34.902
ACW32XX	32.902
ACW30XX	30.902
ACW210XX	28.902
ACW28XX	26.902
ACW26XX	24.902
ACW24XX	22.902
ACW20XX	18.902
ACW18XX	14.902
SIZE DES	DIM "SW"
SCREEN WIDTH	

## Insect Screens

### Insect Screen - Standard Screens

Insect Screen - Standard Screens					
Unit No.	Dimensions (w x h)	White	Stone	Gold Dust	
<b>18</b>	<b>ACW1820</b>	14 <sup>29</sup> / <sub>32</sub> X 17 <sup>15</sup> / <sub>16</sub>	By description	By description	By description
	<b>ACW1824</b>	14 <sup>29</sup> / <sub>32</sub> X 21 <sup>15</sup> / <sub>16</sub>	By description	By description	By description
	<b>ACW1828</b>	14 <sup>29</sup> / <sub>32</sub> X 25 <sup>15</sup> / <sub>16</sub>	By description	By description	By description
	<b>ACW1830</b>	14 <sup>29</sup> / <sub>32</sub> X 29 <sup>15</sup> / <sub>16</sub>	By description	By description	By description
	<b>ACW1834</b>	14 <sup>29</sup> / <sub>32</sub> X 33 <sup>15</sup> / <sub>16</sub>	By description	By description	By description
	<b>ACW1838</b>	14 <sup>29</sup> / <sub>32</sub> X 37 <sup>15</sup> / <sub>16</sub>	By description	By description	By description
	<b>ACW1840</b>	14 <sup>29</sup> / <sub>32</sub> X 41 <sup>15</sup> / <sub>16</sub>	By description	By description	By description
	<b>ACW1844</b>	14 <sup>29</sup> / <sub>32</sub> X 45 <sup>15</sup> / <sub>16</sub>	By description	By description	By description
	<b>ACW1848</b>	14 <sup>29</sup> / <sub>32</sub> X 49 <sup>15</sup> / <sub>16</sub>	By description	By description	By description
	<b>ACW1850</b>	14 <sup>29</sup> / <sub>32</sub> X 53 <sup>15</sup> / <sub>16</sub>	By description	By description	By description
	<b>ACW1854</b>	14 <sup>29</sup> / <sub>32</sub> X 57 <sup>15</sup> / <sub>16</sub>	By description	By description	By description
	<b>ACW1858</b>	14 <sup>29</sup> / <sub>32</sub> X 61 <sup>15</sup> / <sub>16</sub>	By description	By description	By description
	<b>ACW1860</b>	14 <sup>29</sup> / <sub>32</sub> X 65 <sup>15</sup> / <sub>16</sub>	By description	By description	By description
	<b>ACW1864</b>	14 <sup>29</sup> / <sub>32</sub> X 69 <sup>15</sup> / <sub>16</sub>	By description	By description	By description
	<b>ACW1868</b>	14 <sup>29</sup> / <sub>32</sub> X 73 <sup>15</sup> / <sub>16</sub>	By description	By description	By description
	<b>ACW1870</b>	14 <sup>29</sup> / <sub>32</sub> X 77 <sup>15</sup> / <sub>16</sub>	By description	By description	By description
	<b>ACW1874</b>	14 <sup>29</sup> / <sub>32</sub> X 81 <sup>15</sup> / <sub>16</sub>	By description	By description	By description
	<b>ACW1878</b>	14 <sup>29</sup> / <sub>32</sub> X 85 <sup>15</sup> / <sub>16</sub>	By description	By description	By description
<b>ACW1880</b>	14 <sup>29</sup> / <sub>32</sub> X 89 <sup>15</sup> / <sub>16</sub>	By description	By description	By description	

# A-Series Casement & Picture Windows (2008 to Present)

*Standard, Transom and Picture Windows*

## Insect Screens

Insect Screen - Standard Screens					
Unit No.	Dimensions (w x h)	White	Stone	Gold Dust	
<b>20</b>	<b>ACW2020</b>	18 <sup>29</sup> / <sub>32</sub> X 17 <sup>15</sup> / <sub>16</sub>	By description	By description	By description
	<b>ACW2024</b>	18 <sup>29</sup> / <sub>32</sub> X 21 <sup>15</sup> / <sub>16</sub>	By description	By description	By description
	<b>ACW2028</b>	18 <sup>29</sup> / <sub>32</sub> X 25 <sup>15</sup> / <sub>16</sub>	By description	By description	By description
	<b>ACW2030</b>	18 <sup>29</sup> / <sub>32</sub> X 29 <sup>15</sup> / <sub>16</sub>	0400701	0400801	0400601
	<b>ACW2034</b>	18 <sup>29</sup> / <sub>32</sub> X 33 <sup>15</sup> / <sub>16</sub>	0400702	0400802	0400602
	<b>ACW2038</b>	18 <sup>29</sup> / <sub>32</sub> X 37 <sup>15</sup> / <sub>16</sub>	By description	By description	By description
	<b>ACW2040</b>	18 <sup>29</sup> / <sub>32</sub> X 41 <sup>15</sup> / <sub>16</sub>	By description	By description	By description
	<b>ACW2044</b>	18 <sup>29</sup> / <sub>32</sub> X 45 <sup>15</sup> / <sub>16</sub>	By description	By description	By description
	<b>ACW2048</b>	18 <sup>29</sup> / <sub>32</sub> X 49 <sup>15</sup> / <sub>16</sub>	By description	By description	By description
	<b>ACW2050</b>	18 <sup>29</sup> / <sub>32</sub> X 53 <sup>15</sup> / <sub>16</sub>	By description	By description	By description
	<b>ACW2054</b>	18 <sup>29</sup> / <sub>32</sub> X 57 <sup>15</sup> / <sub>16</sub>	By description	By description	By description
	<b>ACW2058</b>	18 <sup>29</sup> / <sub>32</sub> X 61 <sup>15</sup> / <sub>16</sub>	By description	By description	By description
	<b>ACW2060</b>	18 <sup>29</sup> / <sub>32</sub> X 65 <sup>15</sup> / <sub>16</sub>	By description	By description	By description
	<b>ACW2064</b>	18 <sup>29</sup> / <sub>32</sub> X 69 <sup>15</sup> / <sub>16</sub>	By description	By description	By description
	<b>ACW2068</b>	18 <sup>29</sup> / <sub>32</sub> X 73 <sup>15</sup> / <sub>16</sub>	By description	By description	By description
	<b>ACW2070</b>	18 <sup>29</sup> / <sub>32</sub> X 77 <sup>15</sup> / <sub>16</sub>	By description	By description	By description
	<b>ACW2074</b>	18 <sup>29</sup> / <sub>32</sub> X 81 <sup>15</sup> / <sub>16</sub>	By description	By description	By description
	<b>ACW2078</b>	18 <sup>29</sup> / <sub>32</sub> X 89 <sup>15</sup> / <sub>16</sub>	By description	By description	By description
<b>ACW2080</b>	18 <sup>29</sup> / <sub>32</sub> X 89 <sup>15</sup> / <sub>16</sub>	By description	By description	By description	

## Insect Screens

Insect Screen - Standard Screens					
Unit No.	Dimensions (w x h)	White	Stone	Gold Dust	
<b>24</b>	<b>ACW2420</b>	22 <sup>29</sup> / <sub>32</sub> X 17 <sup>15</sup> / <sub>16</sub>	By description	By description	By description
	<b>ACW2424</b>	22 <sup>29</sup> / <sub>32</sub> X 21 <sup>15</sup> / <sub>16</sub>	By description	By description	By description
	<b>ACW2428</b>	22 <sup>29</sup> / <sub>32</sub> X 25 <sup>15</sup> / <sub>16</sub>	By description	By description	By description
	<b>ACW2430</b>	22 <sup>29</sup> / <sub>32</sub> X 29 <sup>15</sup> / <sub>16</sub>	By description	By description	By description
	<b>ACW2434</b>	22 <sup>29</sup> / <sub>32</sub> X 33 <sup>15</sup> / <sub>16</sub>	0400703	0400803	0400603
	<b>ACW2438</b>	22 <sup>29</sup> / <sub>32</sub> X 37 <sup>15</sup> / <sub>16</sub>	0400705	0400805	0400605
	<b>ACW2440</b>	22 <sup>29</sup> / <sub>32</sub> X 41 <sup>15</sup> / <sub>16</sub>	0400706	0400806	0400606
	<b>ACW2444</b>	22 <sup>29</sup> / <sub>32</sub> X 45 <sup>15</sup> / <sub>16</sub>	0400707	0400807	0400607
	<b>ACW2448</b>	22 <sup>29</sup> / <sub>32</sub> X 49 <sup>15</sup> / <sub>16</sub>	0400708	0400808	0400608
	<b>ACW2450</b>	22 <sup>29</sup> / <sub>32</sub> X 53 <sup>15</sup> / <sub>16</sub>	0400709	0400809	0400609
	<b>ACW2454</b>	22 <sup>29</sup> / <sub>32</sub> X 57 <sup>15</sup> / <sub>16</sub>	0400710	0400810	0400610
	<b>ACW2458</b>	22 <sup>29</sup> / <sub>32</sub> X 61 <sup>15</sup> / <sub>16</sub>	By description	By description	By description
	<b>ACW2460</b>	22 <sup>29</sup> / <sub>32</sub> X 65 <sup>15</sup> / <sub>16</sub>	0400711	0400811	0400611
	<b>ACW2464</b>	22 <sup>29</sup> / <sub>32</sub> X 69 <sup>15</sup> / <sub>16</sub>	By description	By description	By description
	<b>ACW2468</b>	22 <sup>29</sup> / <sub>32</sub> X 73 <sup>15</sup> / <sub>16</sub>	By description	By description	By description
	<b>ACW2470</b>	22 <sup>29</sup> / <sub>32</sub> X 77 <sup>15</sup> / <sub>16</sub>	By description	By description	By description
	<b>ACW2474</b>	22 <sup>29</sup> / <sub>32</sub> X 81 <sup>15</sup> / <sub>16</sub>	By description	By description	By description
	<b>ACW2478</b>	22 <sup>29</sup> / <sub>32</sub> X 85 <sup>15</sup> / <sub>16</sub>	By description	By description	By description
	<b>ACW2480</b>	22 <sup>29</sup> / <sub>32</sub> X 89 <sup>15</sup> / <sub>16</sub>	By description	By description	By description

## A-Series Casement & Picture Windows (2008 to Present)

*Standard, Transom and Picture Windows*

### Insect Screens

Insect Screen - Standard Screens					
Unit No.	Dimensions (w x h)	White	Stone	Gold Dust	
<b>26</b>	<b>ACW2624</b>	24 <sup>29</sup> / <sub>32</sub> X 21 <sup>15</sup> / <sub>16</sub>	By description	By description	By description
	<b>ACW2628</b>	24 <sup>29</sup> / <sub>32</sub> X 25 <sup>15</sup> / <sub>16</sub>	By description	By description	By description
	<b>ACW2630</b>	24 <sup>29</sup> / <sub>32</sub> X 29 <sup>15</sup> / <sub>16</sub>	By description	By description	By description
	<b>ACW2634</b>	24 <sup>29</sup> / <sub>32</sub> X 33 <sup>15</sup> / <sub>16</sub>	0400712	0400812	0400612
	<b>ACW2638</b>	24 <sup>29</sup> / <sub>32</sub> X 37 <sup>15</sup> / <sub>16</sub>	0400714	0400814	0400614
	<b>ACW2640</b>	24 <sup>29</sup> / <sub>32</sub> X 41 <sup>15</sup> / <sub>16</sub>	0400715	0400815	0400615
	<b>ACW2644</b>	24 <sup>29</sup> / <sub>32</sub> X 45 <sup>15</sup> / <sub>16</sub>	0400716	0400816	0400616
	<b>ACW2648</b>	24 <sup>29</sup> / <sub>32</sub> X 49 <sup>15</sup> / <sub>16</sub>	0400717	0400817	0400617
	<b>ACW2650</b>	24 <sup>29</sup> / <sub>32</sub> X 53 <sup>15</sup> / <sub>16</sub>	0400718	0400818	0400618
	<b>ACW2654</b>	24 <sup>29</sup> / <sub>32</sub> X 57 <sup>15</sup> / <sub>16</sub>	0400719	0400819	0400619
	<b>ACW2658</b>	24 <sup>29</sup> / <sub>32</sub> X 61 <sup>15</sup> / <sub>16</sub>	By description	By description	By description
	<b>ACW2660</b>	24 <sup>29</sup> / <sub>32</sub> X 65 <sup>15</sup> / <sub>16</sub>	0400720	0400820	0400620
	<b>ACW2664</b>	24 <sup>29</sup> / <sub>32</sub> X 69 <sup>15</sup> / <sub>16</sub>	By description	By description	By description
	<b>ACW2668</b>	24 <sup>29</sup> / <sub>32</sub> X 73 <sup>15</sup> / <sub>16</sub>	By description	By description	By description
	<b>ACW2670</b>	24 <sup>29</sup> / <sub>32</sub> X 77 <sup>15</sup> / <sub>16</sub>	By description	By description	By description
	<b>ACW2674</b>	24 <sup>29</sup> / <sub>32</sub> X 81 <sup>15</sup> / <sub>16</sub>	By description	By description	By description
	<b>ACW2678</b>	24 <sup>29</sup> / <sub>32</sub> X 85 <sup>15</sup> / <sub>16</sub>	By description	By description	By description
<b>ACW2680</b>	24 <sup>29</sup> / <sub>32</sub> X 89 <sup>15</sup> / <sub>16</sub>	By description	By description	By description	

## Insect Screens

Insect Screen - Standard Screens					
Unit No.	Dimensions (w x h)	White	Stone	Gold Dust	
<b>28</b>	<b>ACW2824</b>	26 <sup>29</sup> / <sub>32</sub> X 21 <sup>15</sup> / <sub>16</sub>	By description	By description	By description
	<b>ACW2828</b>	26 <sup>29</sup> / <sub>32</sub> X 25 <sup>15</sup> / <sub>16</sub>	By description	By description	By description
	<b>ACW2830</b>	26 <sup>29</sup> / <sub>32</sub> X 29 <sup>15</sup> / <sub>16</sub>	By description	By description	By description
	<b>ACW2834</b>	26 <sup>29</sup> / <sub>32</sub> X 33 <sup>15</sup> / <sub>16</sub>	By description	By description	By description
	<b>ACW2838</b>	26 <sup>29</sup> / <sub>32</sub> X 37 <sup>15</sup> / <sub>16</sub>	By description	By description	By description
	<b>ACW2840</b>	26 <sup>29</sup> / <sub>32</sub> X 41 <sup>15</sup> / <sub>16</sub>	By description	By description	By description
	<b>ACW2844</b>	26 <sup>29</sup> / <sub>32</sub> X 45 <sup>15</sup> / <sub>16</sub>	By description	By description	By description
	<b>ACW2848</b>	26 <sup>29</sup> / <sub>32</sub> X 49 <sup>15</sup> / <sub>16</sub>	By description	By description	By description
	<b>ACW2850</b>	26 <sup>29</sup> / <sub>32</sub> X 53 <sup>15</sup> / <sub>16</sub>	By description	By description	By description
	<b>ACW2854</b>	26 <sup>29</sup> / <sub>32</sub> X 57 <sup>15</sup> / <sub>16</sub>	By description	By description	By description
	<b>ACW2858</b>	26 <sup>29</sup> / <sub>32</sub> X 61 <sup>15</sup> / <sub>16</sub>	By description	By description	By description
	<b>ACW2860</b>	26 <sup>29</sup> / <sub>32</sub> X 65 <sup>15</sup> / <sub>16</sub>	By description	By description	By description
	<b>ACW2864</b>	26 <sup>29</sup> / <sub>32</sub> X 69 <sup>15</sup> / <sub>16</sub>	By description	By description	By description
	<b>ACW2868</b>	26 <sup>29</sup> / <sub>32</sub> X 73 <sup>15</sup> / <sub>16</sub>	By description	By description	By description
	<b>ACW2870</b>	26 <sup>29</sup> / <sub>32</sub> X 77 <sup>15</sup> / <sub>16</sub>	By description	By description	By description
	<b>ACW2874</b>	26 <sup>29</sup> / <sub>32</sub> X 81 <sup>15</sup> / <sub>16</sub>	By description	By description	By description
	<b>ACW2878</b>	26 <sup>29</sup> / <sub>32</sub> X 85 <sup>15</sup> / <sub>16</sub>	By description	By description	By description
	<b>ACW2880</b>	26 <sup>29</sup> / <sub>32</sub> X 89 <sup>15</sup> / <sub>16</sub>	By description	By description	By description
<b>210</b>	<b>ACW21028</b>	28 <sup>29</sup> / <sub>32</sub> X 25 <sup>15</sup> / <sub>16</sub>	By description	By description	By description
	<b>ACW21030</b>	28 <sup>29</sup> / <sub>32</sub> X 29 <sup>15</sup> / <sub>16</sub>	By description	By description	By description
	<b>ACW21034</b>	28 <sup>29</sup> / <sub>32</sub> X 33 <sup>15</sup> / <sub>16</sub>	By description	By description	By description
	<b>ACW21038</b>	28 <sup>29</sup> / <sub>32</sub> X 37 <sup>15</sup> / <sub>16</sub>	By description	By description	By description
	<b>ACW21040</b>	28 <sup>29</sup> / <sub>32</sub> X 41 <sup>15</sup> / <sub>16</sub>	By description	By description	By description
	<b>ACW21044</b>	28 <sup>29</sup> / <sub>32</sub> X 45 <sup>15</sup> / <sub>16</sub>	By description	By description	By description
	<b>ACW21048</b>	28 <sup>29</sup> / <sub>32</sub> X 49 <sup>15</sup> / <sub>16</sub>	By description	By description	By description
	<b>ACW21050</b>	28 <sup>29</sup> / <sub>32</sub> X 53 <sup>15</sup> / <sub>16</sub>	By description	By description	By description
	<b>ACW21054</b>	28 <sup>29</sup> / <sub>32</sub> X 57 <sup>15</sup> / <sub>16</sub>	By description	By description	By description
	<b>ACW21058</b>	28 <sup>29</sup> / <sub>32</sub> X 61 <sup>15</sup> / <sub>16</sub>	By description	By description	By description
	<b>ACW21060</b>	28 <sup>29</sup> / <sub>32</sub> X 65 <sup>15</sup> / <sub>16</sub>	By description	By description	By description
	<b>ACW21064</b>	28 <sup>29</sup> / <sub>32</sub> X 69 <sup>15</sup> / <sub>16</sub>	By description	By description	By description
	<b>ACW21068</b>	28 <sup>29</sup> / <sub>32</sub> X 73 <sup>15</sup> / <sub>16</sub>	By description	By description	By description
	<b>ACW21070</b>	28 <sup>29</sup> / <sub>32</sub> X 77 <sup>15</sup> / <sub>16</sub>	By description	By description	By description
	<b>ACW21074</b>	28 <sup>29</sup> / <sub>32</sub> X 81 <sup>15</sup> / <sub>16</sub>	By description	By description	By description
	<b>ACW21078</b>	28 <sup>29</sup> / <sub>32</sub> X 85 <sup>15</sup> / <sub>16</sub>	By description	By description	By description
<b>ACW21080</b>	28 <sup>29</sup> / <sub>32</sub> X 89 <sup>15</sup> / <sub>16</sub>	By description	By description	By description	



# A-Series Casement & Picture Windows (2008 to Present)

*Standard, Transom and Picture Windows*

## Insect Screens

Insect Screen - Standard Screens					
	Unit No.	Dimensions (w x h)	White	Stone	Gold Dust
<b>30</b>	<b>ACW3028</b>	30 <sup>29</sup> / <sub>32</sub> X 25 <sup>15</sup> / <sub>16</sub>	By description	By description	By description
	<b>ACW3030</b>	30 <sup>29</sup> / <sub>32</sub> X 29 <sup>15</sup> / <sub>16</sub>	By description	By description	By description
	<b>ACW3034</b>	30 <sup>29</sup> / <sub>32</sub> X 33 <sup>15</sup> / <sub>16</sub>	By description	By description	By description
	<b>ACW3038</b>	30 <sup>29</sup> / <sub>32</sub> X 37 <sup>15</sup> / <sub>16</sub>	By description	By description	By description
	<b>ACW3040</b>	30 <sup>29</sup> / <sub>32</sub> X 41 <sup>15</sup> / <sub>16</sub>	0400721	0400821	0400621
	<b>ACW3044</b>	30 <sup>29</sup> / <sub>32</sub> X 45 <sup>15</sup> / <sub>16</sub>	0400722	0400822	0400622
	<b>ACW3048</b>	30 <sup>29</sup> / <sub>32</sub> X 49 <sup>15</sup> / <sub>16</sub>	0400723	0400823	0400623
	<b>ACW3050</b>	30 <sup>29</sup> / <sub>32</sub> X 53 <sup>15</sup> / <sub>16</sub>	0400724	0400824	0400624
	<b>ACW3054</b>	30 <sup>29</sup> / <sub>32</sub> X 57 <sup>15</sup> / <sub>16</sub>	By description	By description	By description
	<b>ACW3058</b>	30 <sup>29</sup> / <sub>32</sub> X 61 <sup>15</sup> / <sub>16</sub>	By description	By description	By description
	<b>ACW3060</b>	30 <sup>29</sup> / <sub>32</sub> X 65 <sup>15</sup> / <sub>16</sub>	0400725	0400825	0400625
	<b>ACW3064</b>	30 <sup>29</sup> / <sub>32</sub> X 69 <sup>15</sup> / <sub>16</sub>	By description	By description	By description
	<b>ACW3068</b>	30 <sup>29</sup> / <sub>32</sub> X 73 <sup>15</sup> / <sub>16</sub>	By description	By description	By description
	<b>ACW3070</b>	30 <sup>29</sup> / <sub>32</sub> X 77 <sup>15</sup> / <sub>16</sub>	By description	By description	By description
	<b>ACW3074</b>	30 <sup>29</sup> / <sub>32</sub> X 81 <sup>15</sup> / <sub>16</sub>	By description	By description	By description
	<b>ACW3078</b>	30 <sup>29</sup> / <sub>32</sub> X 85 <sup>15</sup> / <sub>16</sub>	By description	By description	By description
<b>ACW3080</b>	30 <sup>29</sup> / <sub>32</sub> X 89 <sup>15</sup> / <sub>16</sub>	By description	By description	By description	
<b>32</b>	<b>ACW3230</b>	32 <sup>29</sup> / <sub>32</sub> X 29 <sup>15</sup> / <sub>16</sub>	By description	By description	By description
	<b>ACW3234</b>	32 <sup>29</sup> / <sub>32</sub> X 33 <sup>15</sup> / <sub>16</sub>	By description	By description	By description
	<b>ACW3238</b>	32 <sup>29</sup> / <sub>32</sub> X 37 <sup>15</sup> / <sub>16</sub>	By description	By description	By description
	<b>ACW3240</b>	32 <sup>29</sup> / <sub>32</sub> X 41 <sup>15</sup> / <sub>16</sub>	By description	By description	By description
	<b>ACW3244</b>	32 <sup>29</sup> / <sub>32</sub> X 45 <sup>15</sup> / <sub>16</sub>	By description	By description	By description
	<b>ACW3248</b>	32 <sup>29</sup> / <sub>32</sub> X 49 <sup>15</sup> / <sub>16</sub>	By description	By description	By description
	<b>ACW3250</b>	32 <sup>29</sup> / <sub>32</sub> X 53 <sup>15</sup> / <sub>16</sub>	By description	By description	By description
	<b>ACW3254</b>	32 <sup>29</sup> / <sub>32</sub> X 57 <sup>15</sup> / <sub>16</sub>	By description	By description	By description
	<b>ACW3258</b>	32 <sup>29</sup> / <sub>32</sub> X 61 <sup>15</sup> / <sub>16</sub>	By description	By description	By description
	<b>ACW3260</b>	32 <sup>29</sup> / <sub>32</sub> X 65 <sup>15</sup> / <sub>16</sub>	By description	By description	By description
	<b>ACW3264</b>	32 <sup>29</sup> / <sub>32</sub> X 69 <sup>15</sup> / <sub>16</sub>	By description	By description	By description
	<b>ACW3268</b>	32 <sup>29</sup> / <sub>32</sub> X 73 <sup>15</sup> / <sub>16</sub>	By description	By description	By description
	<b>ACW3270</b>	32 <sup>29</sup> / <sub>32</sub> X 77 <sup>15</sup> / <sub>16</sub>	By description	By description	By description
	<b>ACW3274</b>	32 <sup>29</sup> / <sub>32</sub> X 81 <sup>15</sup> / <sub>16</sub>	By description	By description	By description
<b>ACW3278</b>	32 <sup>29</sup> / <sub>32</sub> X 85 <sup>15</sup> / <sub>16</sub>	By description	By description	By description	
<b>ACW3280</b>	32 <sup>29</sup> / <sub>32</sub> X 89 <sup>15</sup> / <sub>16</sub>	By description	By description	By description	

## Insect Screens

Insect Screen - Standard Screens					
Unit No.	Dimensions (w x h)	White	Stone	Gold Dust	
<b>34</b>	<b>ACW3430</b>	34 <sup>29</sup> / <sub>32</sub> X 29 <sup>15</sup> / <sub>16</sub>	By description	By description	By description
	<b>ACW3434</b>	34 <sup>29</sup> / <sub>32</sub> X 33 <sup>15</sup> / <sub>16</sub>	By description	By description	By description
	<b>ACW3438</b>	34 <sup>29</sup> / <sub>32</sub> X 37 <sup>15</sup> / <sub>16</sub>	By description	By description	By description
	<b>ACW3440</b>	34 <sup>29</sup> / <sub>32</sub> X 41 <sup>15</sup> / <sub>16</sub>	By description	By description	By description
	<b>ACW3444</b>	34 <sup>29</sup> / <sub>32</sub> X 45 <sup>15</sup> / <sub>16</sub>	By description	By description	By description
	<b>ACW3448</b>	34 <sup>29</sup> / <sub>32</sub> X 49 <sup>15</sup> / <sub>16</sub>	By description	By description	By description
	<b>ACW3450</b>	34 <sup>29</sup> / <sub>32</sub> X 53 <sup>15</sup> / <sub>16</sub>	By description	By description	By description
	<b>ACW3454</b>	34 <sup>29</sup> / <sub>32</sub> X 57 <sup>15</sup> / <sub>16</sub>	By description	By description	By description
	<b>ACW3458</b>	34 <sup>29</sup> / <sub>32</sub> X 61 <sup>15</sup> / <sub>16</sub>	By description	By description	By description
	<b>ACW3460</b>	34 <sup>29</sup> / <sub>32</sub> X 65 <sup>15</sup> / <sub>16</sub>	By description	By description	By description
	<b>ACW3464</b>	34 <sup>29</sup> / <sub>32</sub> X 69 <sup>15</sup> / <sub>16</sub>	By description	By description	By description
	<b>ACW3468</b>	34 <sup>29</sup> / <sub>32</sub> X 73 <sup>15</sup> / <sub>16</sub>	By description	By description	By description
	<b>ACW3470</b>	34 <sup>29</sup> / <sub>32</sub> X 77 <sup>15</sup> / <sub>16</sub>	By description	By description	By description
	<b>ACW3474</b>	34 <sup>29</sup> / <sub>32</sub> X 81 <sup>15</sup> / <sub>16</sub>	By description	By description	By description
	<b>ACW3478</b>	34 <sup>29</sup> / <sub>32</sub> X 85 <sup>15</sup> / <sub>16</sub>	By description	By description	By description
	<b>ACW3480</b>	34 <sup>29</sup> / <sub>32</sub> X 89 <sup>15</sup> / <sub>16</sub>	By description	By description	By description
<b>36</b>	<b>ACW3634</b>	36 <sup>29</sup> / <sub>32</sub> X 33 <sup>15</sup> / <sub>16</sub>	By description	By description	By description
	<b>ACW3638</b>	36 <sup>29</sup> / <sub>32</sub> X 37 <sup>15</sup> / <sub>16</sub>	By description	By description	By description
	<b>ACW3640</b>	36 <sup>29</sup> / <sub>32</sub> X 41 <sup>15</sup> / <sub>16</sub>	By description	By description	By description
	<b>ACW3644</b>	36 <sup>29</sup> / <sub>32</sub> X 45 <sup>15</sup> / <sub>16</sub>	By description	By description	By description
	<b>ACW3648</b>	36 <sup>29</sup> / <sub>32</sub> X 49 <sup>15</sup> / <sub>16</sub>	By description	By description	By description
	<b>ACW3650</b>	36 <sup>29</sup> / <sub>32</sub> X 53 <sup>15</sup> / <sub>16</sub>	By description	By description	By description
	<b>ACW3654</b>	36 <sup>29</sup> / <sub>32</sub> X 57 <sup>15</sup> / <sub>16</sub>	By description	By description	By description
	<b>ACW3658</b>	36 <sup>29</sup> / <sub>32</sub> X 61 <sup>15</sup> / <sub>16</sub>	By description	By description	By description
	<b>ACW3660</b>	36 <sup>29</sup> / <sub>32</sub> X 65 <sup>15</sup> / <sub>16</sub>	By description	By description	By description
	<b>ACW3664</b>	36 <sup>29</sup> / <sub>32</sub> X 69 <sup>15</sup> / <sub>16</sub>	By description	By description	By description
	<b>ACW3668</b>	36 <sup>29</sup> / <sub>32</sub> X 73 <sup>15</sup> / <sub>16</sub>	By description	By description	By description
	<b>ACW3670</b>	36 <sup>29</sup> / <sub>32</sub> X 77 <sup>15</sup> / <sub>16</sub>	By description	By description	By description
	<b>ACW3674</b>	36 <sup>29</sup> / <sub>32</sub> X 81 <sup>15</sup> / <sub>16</sub>	By description	By description	By description
	<b>ACW3678</b>	36 <sup>29</sup> / <sub>32</sub> X 85 <sup>15</sup> / <sub>16</sub>	By description	By description	By description
<b>ACW3680</b>	36 <sup>29</sup> / <sub>32</sub> X 89 <sup>15</sup> / <sub>16</sub>	By description	By description	By description	

# A-Series Casement & Picture Windows (2008 to Present)

*Standard, Transom and Picture Windows*

## Insect Screens

Insect Screen - Standard Screens					
Unit No.	ACW#	Dimensions (w x h)	White	Stone	Gold Dust
<b>38</b>	<b>ACW3834</b>	38 <sup>29</sup> / <sub>32</sub> X 33 <sup>15</sup> / <sub>16</sub>	By description	By description	By description
	<b>ACW3838</b>	38 <sup>29</sup> / <sub>32</sub> X 37 <sup>15</sup> / <sub>16</sub>	By description	By description	By description
	<b>ACW3840</b>	38 <sup>29</sup> / <sub>32</sub> X 41 <sup>15</sup> / <sub>16</sub>	By description	By description	By description
	<b>ACW3844</b>	38 <sup>29</sup> / <sub>32</sub> X 45 <sup>15</sup> / <sub>16</sub>	By description	By description	By description
	<b>ACW3848</b>	38 <sup>29</sup> / <sub>32</sub> X 49 <sup>15</sup> / <sub>16</sub>	By description	By description	By description
	<b>ACW3850</b>	38 <sup>29</sup> / <sub>32</sub> X 53 <sup>15</sup> / <sub>16</sub>	By description	By description	By description
	<b>ACW3854</b>	38 <sup>29</sup> / <sub>32</sub> X 57 <sup>15</sup> / <sub>16</sub>	By description	By description	By description
	<b>ACW3858</b>	38 <sup>29</sup> / <sub>32</sub> X 61 <sup>15</sup> / <sub>16</sub>	By description	By description	By description
	<b>ACW3860</b>	38 <sup>29</sup> / <sub>32</sub> X 65 <sup>15</sup> / <sub>16</sub>	By description	By description	By description
	<b>ACW3864</b>	38 <sup>29</sup> / <sub>32</sub> X 69 <sup>15</sup> / <sub>16</sub>	By description	By description	By description
	<b>ACW3868</b>	38 <sup>29</sup> / <sub>32</sub> X 73 <sup>15</sup> / <sub>16</sub>	By description	By description	By description
	<b>ACW3870</b>	38 <sup>29</sup> / <sub>32</sub> X 77 <sup>15</sup> / <sub>16</sub>	By description	By description	By description
	<b>ACW3874</b>	38 <sup>29</sup> / <sub>32</sub> X 81 <sup>15</sup> / <sub>16</sub>	By description	By description	By description
	<b>ACW3878</b>	38 <sup>29</sup> / <sub>32</sub> X 85 <sup>15</sup> / <sub>16</sub>	By description	By description	By description
<b>ACW3880</b>	38 <sup>29</sup> / <sub>32</sub> X 89 <sup>15</sup> / <sub>16</sub>	By description	By description	By description	
<b>310</b>	<b>ACW31038</b>	40 <sup>29</sup> / <sub>32</sub> X 37 <sup>15</sup> / <sub>16</sub>	By description	By description	By description
	<b>ACW31040</b>	40 <sup>29</sup> / <sub>32</sub> X 41 <sup>15</sup> / <sub>16</sub>	By description	By description	By description
	<b>ACW31044</b>	40 <sup>29</sup> / <sub>32</sub> X 45 <sup>15</sup> / <sub>16</sub>	By description	By description	By description
	<b>ACW31048</b>	40 <sup>29</sup> / <sub>32</sub> X 49 <sup>15</sup> / <sub>16</sub>	By description	By description	By description
	<b>ACW31050</b>	40 <sup>29</sup> / <sub>32</sub> X 53 <sup>15</sup> / <sub>16</sub>	By description	By description	By description
	<b>ACW31054</b>	40 <sup>29</sup> / <sub>32</sub> X 57 <sup>15</sup> / <sub>16</sub>	By description	By description	By description
	<b>ACW31058</b>	40 <sup>29</sup> / <sub>32</sub> X 61 <sup>15</sup> / <sub>16</sub>	By description	By description	By description
	<b>ACW31060</b>	40 <sup>29</sup> / <sub>32</sub> X 65 <sup>15</sup> / <sub>16</sub>	By description	By description	By description
	<b>ACW31064</b>	40 <sup>29</sup> / <sub>32</sub> X 69 <sup>15</sup> / <sub>16</sub>	By description	By description	By description
	<b>ACW31068</b>	40 <sup>29</sup> / <sub>32</sub> X 73 <sup>15</sup> / <sub>16</sub>	By description	By description	By description
	<b>ACW31070</b>	40 <sup>29</sup> / <sub>32</sub> X 77 <sup>15</sup> / <sub>16</sub>	By description	By description	By description
	<b>ACW31074</b>	40 <sup>29</sup> / <sub>32</sub> X 81 <sup>15</sup> / <sub>16</sub>	By description	By description	By description
<b>ACW31078</b>	40 <sup>29</sup> / <sub>32</sub> X 85 <sup>15</sup> / <sub>16</sub>	By description	By description	By description	
<b>ACW31080</b>	40 <sup>29</sup> / <sub>32</sub> X 89 <sup>15</sup> / <sub>16</sub>	By description	By description	By description	

Insect Screen - Standard Screens						
Unit No.	Dimensions (w x h)	White	Stone	Gold Dust		
<b>40</b>	<b>ACW4038</b>	42 <sup>29</sup> / <sub>32</sub> X 37 <sup>15</sup> / <sub>16</sub>	By description	By description	By description	
	<b>ACW4040</b>	42 <sup>29</sup> / <sub>32</sub> X 41 <sup>15</sup> / <sub>16</sub>	By description	By description	By description	
	<b>ACW4044</b>	42 <sup>29</sup> / <sub>32</sub> X 45 <sup>15</sup> / <sub>16</sub>	By description	By description	By description	
	<b>ACW4048</b>	42 <sup>29</sup> / <sub>32</sub> X 49 <sup>15</sup> / <sub>16</sub>	By description	By description	By description	
	<b>ACW4050</b>	42 <sup>29</sup> / <sub>32</sub> X 53 <sup>15</sup> / <sub>16</sub>	By description	By description	By description	
	<b>ACW4054</b>	42 <sup>29</sup> / <sub>32</sub> X 57 <sup>15</sup> / <sub>16</sub>	By description	By description	By description	
	<b>ACW4058</b>	42 <sup>29</sup> / <sub>32</sub> X 61 <sup>15</sup> / <sub>16</sub>	By description	By description	By description	
	<b>ACW4060</b>	42 <sup>29</sup> / <sub>32</sub> X 65 <sup>15</sup> / <sub>16</sub>	By description	By description	By description	
	<b>ACW4064</b>	42 <sup>29</sup> / <sub>32</sub> X 69 <sup>15</sup> / <sub>16</sub>	By description	By description	By description	
	<b>ACW4068</b>	42 <sup>29</sup> / <sub>32</sub> X 73 <sup>15</sup> / <sub>16</sub>	By description	By description	By description	
	<b>ACW4070</b>	42 <sup>29</sup> / <sub>32</sub> X 77 <sup>15</sup> / <sub>16</sub>	By description	By description	By description	
	<b>ACW4074</b>	42 <sup>29</sup> / <sub>32</sub> X 81 <sup>15</sup> / <sub>16</sub>	By description	By description	By description	
	<b>ACW4078</b>	42 <sup>29</sup> / <sub>32</sub> X 85 <sup>15</sup> / <sub>16</sub>	By description	By description	By description	
	<b>ACW4080</b>	42 <sup>29</sup> / <sub>32</sub> X 89 <sup>15</sup> / <sub>16</sub>	By description	By description	By description	

Insect Screen Parts			
Insect Screen Strike			
		Color	Order No.
		Tan	1361393
		White	1361395
		Black	9134999

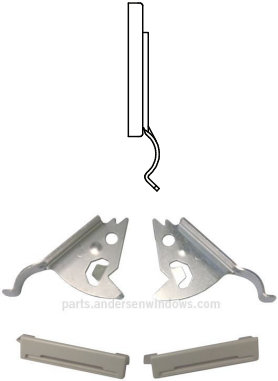
Screen Latch with Housing			
	<b>Note:</b> Ships as a pair. Terratone used with screens that have a wood veneer (all species/finishes)?	<b>Color</b>	<b>Order No.</b>
		White	1693417
		Terratone	2791264
		Sandtone	1191313
		Forest Green	0381364
		Canvas	9014568
		Cocoa Bean	9014570
		Prairie Grass	9014571
		Dove Gray	9014572
		Black	9014573
		Red Rock	9014574
		Dark Bronze	9076928
		Gold Dust	9014569
Stone	By description		

# A-Series Casement & Picture Windows (2008 to Present)

Standard, Transom and Picture Windows

## Grilles

### Grilles

#### Grilles - Standard / Interior

**Note:**

See iQ+ for additional options. Replacement removable interior grilles for standard and custom-sized windows are made to order. Grilles include fasteners. Permanently applied interior/exterior grilles can only be ordered by Andersen Territory Service Representatives, Andersen Service Dealers and Providers available in the Service Replacement Only section [page 81](#).

#### Grilles - Standard / Interior

**To order, state:**

1. Description of Part (Interior Grille, Exterior/Interior color/finish, Pattern, Profile)
2. Product ID (from product label), see [page 6](#)



**Exterior color options:**

White	Canvas	Dove Gray	Sandtone
Terratone	Forest Green	Prairie Grass	Red Rock
Black	Dark Bronze	Cocoa Bean	



**Interior species/finish/color options:**

	Clear Coat	Honey	White	Cherry (Not Shown)
Oak	Cinnamon	Russet	Birch Bark	Mahogany (Not Shown)
Maple	Mocha	Espresso	Primed	Douglas Fir (Not Shown)

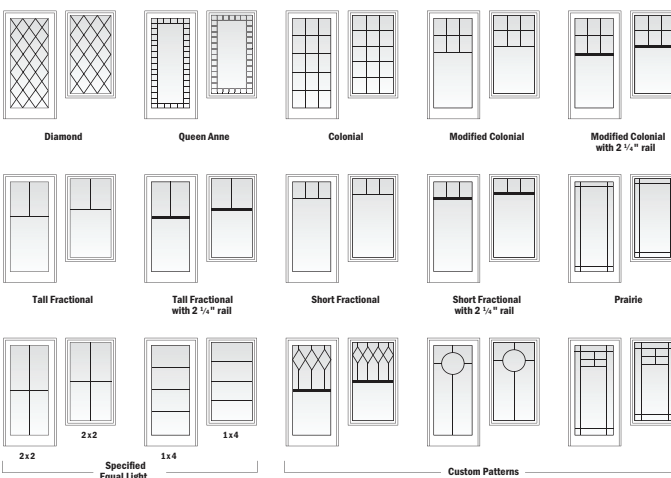

**Pattern options:**

Diamond	Queen Anne	Colonial	Modified Colonial	Modified Colonial w/ SCR
Tall Fractional	Tall Fractional w/SCR	Short Fractional	Short Fractional w/SCR	Prairie
Specified Equal Light		Custom		

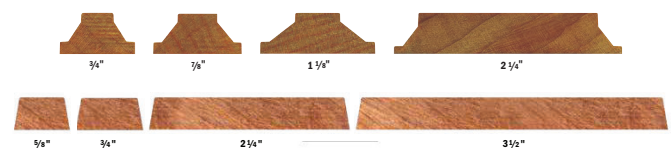

**Profile options:**

Traditional Sizes	3/4 inch	7/8 inch	1 1/8 inch	2 1/4 inch
Contemporary Sizes	5/8 inch	3/4 inch	2 1/4 inch	3 1/2 inch

**Interior Grille Parts**

**Interior Grille Fastener**

	<b>Color</b>	<b>Order No.</b>
	White	0174951
	Terratone	0174952
	Sandtone	0174953
	Forest Green	0174955
	Canvas	0174954
	Prairie Grass	9010542
	Cocoa Bean	9010541
	Dove Gray	9010540
	Red Rock	9010538
	Black	9010539
	Dark Bronze	9020288

**Installation Tool**

	<b>Order No.</b>
	9019326

# A-Series Casement & Picture Windows (2008 to Present)

Standard, Transom and Picture Windows

## Hardware

### Hardware

#### Operator Chart

**Note:**

- Use Casement Split Arm Operator on these units. See [page 42](#)
- Use Casement 14" Straight Arm Operator on these units. See [page 44](#)
- Use Casement 12" Straight Arm Operator on these units. See [page 44](#)

Unit Size			WIDTH													
			18	20	24	26	28	210	30	32	34	36	38	310	40	
Rough Opening (in)			20	24	28	30	32	34	36	38	40	42	44	46	48	
Unit (in)			19 1/4	23 1/4	27 1/4	29 1/4	31 1/4	33 1/4	35 1/4	37 1/4	39 1/4	41 1/4	43 1/4	45 1/4	47 1/4	
HEIGHT	20	24	23 1/4	1820	2020	2420										
	24	28	27 1/4	1824	2024	2424	2624	2824								
	28	32	31 1/4	1828	2028	2428	2628	2828	21028	3028						
	30	36	35 1/4	1830	2030	2430	2630	2830	21030	3030	3230	3430				
	34	40	39 1/4	1834	2034	2434	2634	2834	21034	3034	3234	3434	3634	3834		
	38	44	43 1/4	1838	2038	2438	2638	2838	21038	3038	3238	3438	3638	3838	31038	4038
	40	48	47 1/4	1840	2040	2440	2640	2840	21040	3040	3240	3440	3640	3840	31040	4040
	44	52	51 1/4	1844	2044	2444	2644	2844	21044	3044	3244	3444	3644	3844	31044	4044
	48	56	55 1/4	1848	2048	2448	2648	2848	21048	3048	3248	3448	3648	3848	31048	4048
	50	60	59 1/4	1850	2050	2450	2650	2850	21050	3050	3250	3450	3650	3850	31050	4050
	54	64	63 1/4	1854	2054	2454	2654	2854	21054	3054	3254	3454	3654	3854	31054	4054
	58	68	67 1/4	1858	2058	2458	2658	2858	21058	3058	3258	3458	3658	3858	31058	4058
	60	72	71 1/4	1860	2060	2460	2660	2860	21060	3060	3260	3460	3660	3860	31060	4060
	64	76	75 1/4	1864	2064	2464	2664	2864	21064	3064	3264	3464	3664	3864	31064	4064
	68	80	79 1/4	1868	2068	2468	2668	2868	21068	3068	3268	3468	3668	3868	31068	4068
	70	84	83 1/4	1870	2070	2470	2670	2870	21070	3070	3270	3470	3670	3870	31070	4070
74	88	87 1/4	1874	2074	2474	2674	2874	21074	3074	3274	3474	3674	3874	31074	4074	
78	92	91 1/4	1878	2078	2478	2678	2878	21078	3078	3278	3478	3678	3878	31078	4078	
80	96	95 1/4	1880	2080	2480	2680	2880	21080	3080	3280	3480	3680	3880	31080	4080	

## Hardware

### Split Arm Operator

**Note:**

See [Service Guide 9014620](#) for operator adjustment.

See [Service Guide 9011001](#) for operator replacement.

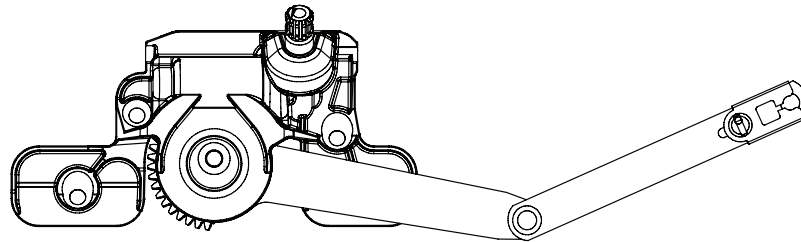

**Operator**

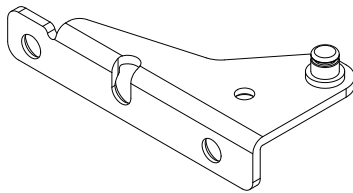

**Sash Bracket**

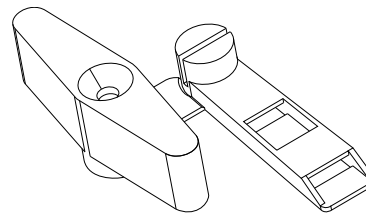

**Temporary Handle**

**Split Arm Operator**

### Operator Picture

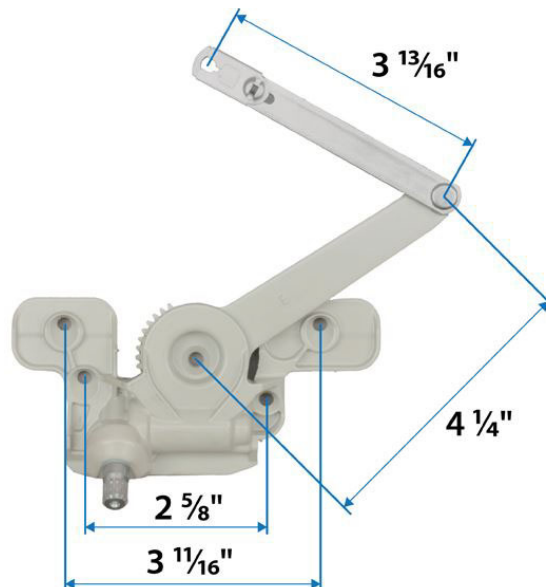





# A-Series Casement & Picture Windows (2008 to Present)

Standard, Transom and Picture Windows

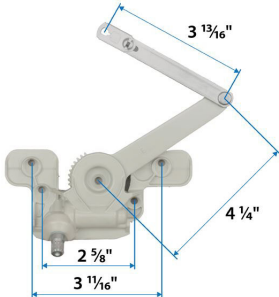
## Hardware

Split Arm Operator with Screws			
		<b>Standard</b>	<b>Corrosion Resistant</b>
		1361484	1361481
Split Arm Sash Bracket with Screws			
		<b>Corrosion Resistant</b>	
		<b>Left</b>	<b>Right</b>
		9019493	9019492

## Hardware

### Straight Arm Operator

**Note:**

See [Service Guide 9011001](#) for operator replacement.

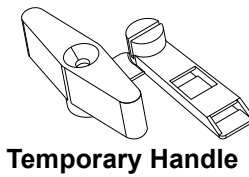
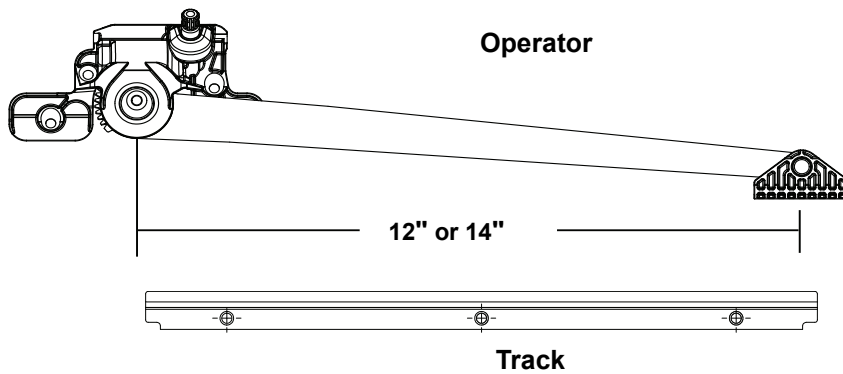

### Straight Arm Operator

#### Operator and Track Picture

Straight Arm Operator with Screws / 12"

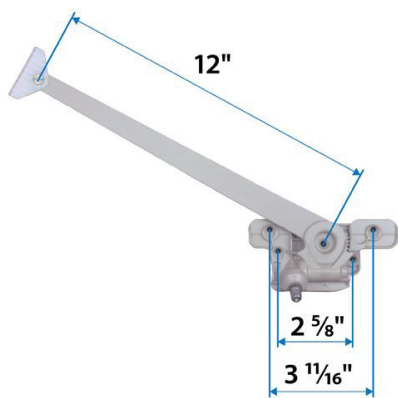

Straight Arm Operator with Screws / 14"

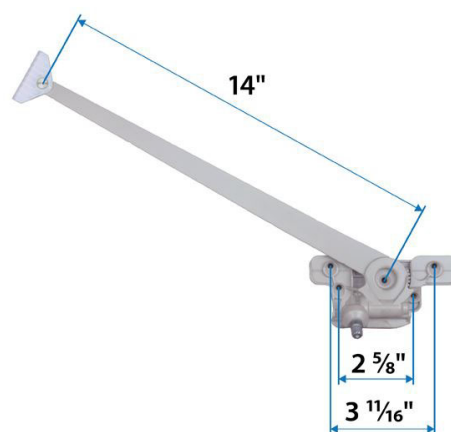

patent andersenwindows.com



# A-Series Casement & Picture Windows (2008 to Present)

Standard, Transom and Picture Windows

## Hardware

### Straight Arm Operator with Screws / 12"

**Note:**

Part number is typically marked on operator.

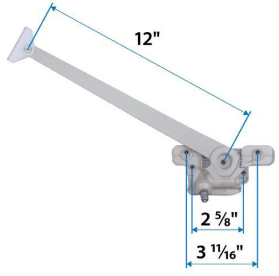
	<b>Standard</b>		<b>Corrosion Resistant</b>	
	<b>Left</b>	<b>Right</b>	<b>Left</b>	<b>Right</b>
	9052565	9052564	9142381	9142380

### Straight Arm Operator with Screws / 14"

**Note:**

Part number is typically marked on operator.

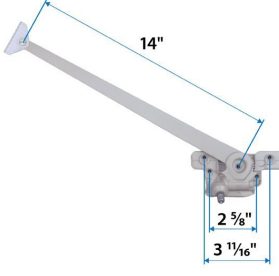
	<b>Standard</b>		<b>Corrosion Resistant</b>	
	<b>Left</b>	<b>Right</b>	<b>Left</b>	<b>Right</b>
	1361483	1361482	9142379	9142378

### Straight Arm Track Kit with Screws Ref. No. 2 [page 23](#)

**Note:**

Track is universal.

	<b>Standard</b>	<b>Corrosion Resistant</b>
	9019489	9019494

### Straight Arm Operator Track Limiter

**Note:**

Track is universal.

	<b>Order No.</b>
	9152138

### Temporary Handle - Operator and Lock

	<b>Order No.</b>
	1361394

## Hardware

### Hinge Chart

**Note:**

- Use 10" Hinge on these units. See [page 47](#)
- Use 10" Egress Hinge on these units. See [page 47](#)
- Use 13" Hinge on these units. See [page 47](#)
- Use 13" Egress Hinge on these units. See [page 47](#)

				WIDTH												
Unit Size				18	20	24	26	28	210	30	32	34	36	38	310	40
Rough Opening (in)				20	24	28	30	32	34	36	38	40	42	44	46	48
Unit (in)				19 1/4	23 1/4	27 1/4	29 1/4	31 1/4	33 1/4	35 1/4	37 1/4	39 1/4	41 1/4	43 1/4	45 1/4	47 1/4
HEIGHT	20	24	23 1/4	1820	2020	2420										
	24	28	27 1/4	1824	2024	2424	2624	2824								
	28	32	31 1/4	1828	2028	2428	2628	2828	21028	3028						
	30	36	35 1/4	1830	2030	2430	2630	2830	21030	3030	3230	3430				
	34	40	39 1/4	1834	2034	2434	2634	2834	21034	3034	3234	3434	3634	3834		
	38	44	43 1/4	1838	2038	2438	2638	2838	21038	3038	3238	3438	3638	3838	31038	4038
	40	48	47 1/4	1840	2040	2440	2640	2840	21040	3040	3240	3440	3640	3840	31040	4040
	44	52	51 1/4	1844	2044	2444	2644	2844	21044	3044	3244	3444	3644	3844	31044	4044
	48	56	55 1/4	1848	2048	2448	2648	2848	21048	3048	3248	3448	3648	3848	31048	4048
	50	60	59 1/4	1850	2050	2450	2650	2850	21050	3050	3250	3450	3650	3850	31050	4050
	54	64	63 1/4	1854	2054	2454	2654	2854	21054	3054	3254	3454	3654	3854	31054	4054
	58	68	67 1/4	1858	2058	2458	2658	2858	21058	3058	3258	3458	3658	3858	31058	4058
	60	72	71 1/4	1860	2060	2460	2660	2860	21060	3060	3260	3460	3660	3860	31060	4060
	64	76	75 1/4	1864	2064	2464	2664	2864	21064	3064	3264	3464	3664	3864	31064	4064
	68	80	79 1/4	1868	2068	2468	2668	2868	21068	3068	3268	3468	3668	3868	31068	4068
	70	84	83 1/4	1870	2070	2470	2670	2870	21070	3070	3270	3470	3670	3870	31070	4070
74	88	87 1/4	1874	2074	2474	2674	2874	21074	3074	3274	3474	3674	3874	31074	4074	
78	92	91 1/4	1878	2078	2478	2678	2878	21078	3078	3278	3478	3678	3878	31078	4078	
80	96	95 1/4	1880	2080	2480	2680	2880	21080	3080	3280	3480	3680	3880	31080	4080	

# A-Series Casement & Picture Windows (2008 to Present)

Standard, Transom and Picture Windows

## Hardware

### Hinge Kits

**Note:**

A left-hand unit uses a LH hinge kit on the sill and a RH hinge kit on the head.  
See [Service Guide 9010998](#) for hinge replacement.

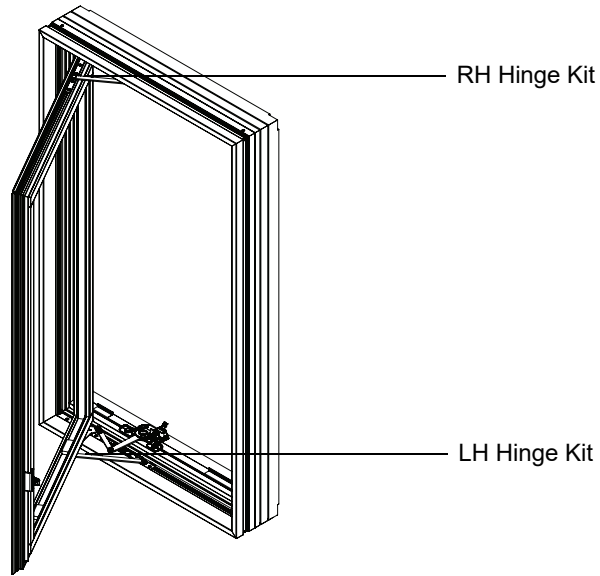

Left-Hand Unit Shown

### Hinge Kit - 10" Opening

**Note:**

Kit contains hinge arm, hinge track, screws and [Service Guide 9010998](#). LH hinge kit shown.

	<b>Standard</b>		<b>Egress</b>	
	<b>Left</b>	<b>Right</b>	<b>Standard</b>	
	9019498	9019497	<b>Left</b>	<b>Right</b>
	<b>Corrosion Resistant</b>		<b>Corrosion Resistant</b>	
	<b>Left</b>	<b>Right</b>	<b>Left</b>	<b>Right</b>
	9019510	9019509	9019512	9019511

### Hinge Kit - 13" Opening

**Note:**

Kit contains hinge arm, hinge track, screws and [Service Guide 9010998](#). Corrosion resistant finish is standard with 13" egress hinge kit. LH hinge kit shown.

	<b>Standard</b>		<b>Egress</b>	
	<b>Left</b>	<b>Right</b>		
	9019502	9019501		
	<b>Corrosion Resistant</b>		<b>Corrosion Resistant</b>	
	<b>Left</b>	<b>Right</b>	<b>Left</b>	<b>Right</b>
	9019514	9019513	9152135	9152136

## Hardware

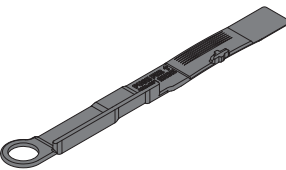
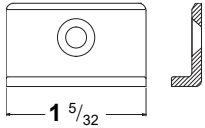
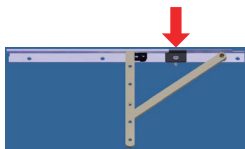
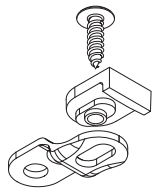
Hinge Parts			
Adjustment Wrench			
		Order No.	
		9006253	
Sill Bracket			
<b>Note:</b> See <a href="#">Accessory Guide 9160159</a> .			
		Order No.	
		Left	Right
		9163529	9163530
Casement Hinge Clip			
		Order No.	
		9142679	
Hinge Pin Kit - Support Bracket			
<b>Note:</b> See <a href="#">Accessory/Service Guide 9184696</a> .			
		Order No.	
		9184704	

# A-Series Casement & Picture Windows (2008 to Present)

Standard, Transom and Picture Windows

## Hardware

### Hardware Packs - Folding

**Note:**

See [Accessory Guide 0005171](#).

#### Hardware Pack - Folding / Traditional

	<b>Pack Includes:</b> (1) Lock bezel (1) Lock handle (1) Handle (1) Cover (1) Nylon washer	<b>Finish</b>	<b>Order No.</b>
		Stone	0400201
		White	0400202
		Gold Dust	0400203
		Black	0400213
		Bright Brass	9005392
		Satin Nickel	9005393
		Oil Rubbed Bronze	9005394
		Antique Brass	9005395
		Brushed Chrome	9005396
		Polished Chrome	9005397
		Distressed Bronze	9016116
		Distressed Nickel	9016117

#### Hardware Pack - Folding / Contemporary

	<b>Pack Includes:</b> (1) Lock bezel (1) Lock handle (1) Handle (1) Cover (1) Nylon washer	<b>Finish</b>	<b>Order No.</b>
		Stone	0400207
		White	0400208
		Gold Dust	0400209
		Black	0400215
		Bright Brass	9005404
		Satin Nickel	9005594
		Oil Rubbed Bronze	9005595

### Operator Covers

#### Operator Cover — Traditional

	<b>Note:</b> Stone, white, black, and gold dust covers are not available, replace with complete hardware set <a href="#">page 49</a> .	<b>Finish</b>	<b>Order No.</b>
		Bright Brass	9016078
		Satin Nickel	9016079
		Oil Rubbed Bronze	9016080
		Antique Brass	9016081
		Brushed Chrome	9016082
		Polished Chrome	9016083
		Distressed Bronze	9016084
		Distressed Nickel	9016085

#### Operator Cover - Contemporary

	<b>Note:</b> Stone, white, black, and gold dust covers are not available, replace with complete hardware set <a href="#">page 49</a> .	<b>Finish</b>	<b>Order No.</b>
		Bright Brass	9016092
		Satin Nickel	9016093
Oil Rubbed Bronze	9016094		

## Hardware

### Operator Handles

#### Operator Handle - Folding / Traditional

	<b>Note:</b> Stone, white, black, and gold dust handles are not available, replace with complete hardware set <a href="#">page 49</a> .	<b>Finish</b>	<b>Order No.</b>
		Bright Brass	9016099
		Antique Brass	9016102
		Satin Nickel	9016100
		Distressed Nickel	9016106
		Oil Rubbed Bronze	9016101
		Distressed Bronze	9016105
		Brushed Chrome	9016103
Polished Chrome	9016104		

#### Operator Handle - Folding / Contemporary

	<b>Note:</b> Stone, white, black, and gold dust handles are not available, replace with complete hardware set <a href="#">page 49</a> .	<b>Finish</b>	<b>Order No.</b>
		Bright Brass	9016113
		Satin Nickel	9016114
		Oil Rubbed Bronze	9016115

#### Set Screw / Zinc

	<b>Note:</b> Used on both the traditional and contemporary operator handles.	<b>Order No.</b>
		9066667

#### Washer - Folding

	<b>Note:</b> Opaque nylon washer used between handle and cover of Contemporary and Traditional folding hardware.	<b>Order No.</b>
		9069020

#### Handle - T / Metal

	<b>Note:</b> Set screw available by description. #10 - 32 x .215 LG. Specify size, color and handle style.	<b>Color</b>	<b>Order No.</b>
		Stone	1361487
		White	1361488

#### Handle - Compact Operator

		<b>Color</b>	<b>Order No.</b>
		Stone	1361804
		White	1351334

#### Temporary Handle - Operator and Lock

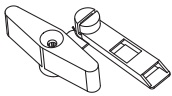
		<b>Order No.</b>
		1361394





# A-Series Casement & Picture Windows (2008 to Present)

Standard, Transom and Picture Windows

## Hardware

<b>Locks (October 2013 - present)</b>			
<b>Lock with Screws - Single (October 2013 - present)</b>			
	<b>Note:</b> Use for unit dimension heights of 24.875" or less.	<b>Left</b>	<b>Right</b>
		1351433	1351434
<b>Lock with Screws - Tandem 12 (October 2013 - present)</b>			
	<b>Note:</b> Use for unit dimension heights greater than 24.875" and less than or equal to 32.625".	<b>Left</b>	<b>Right</b>
		1361894	1361895
<b>Lock with Screws - Tandem 18 (October 2013 - present)</b>			
	<b>Note:</b> Use for unit dimension heights greater than 32.625" and less than or equal to 39.500".	<b>Left</b>	<b>Right</b>
		9098388	9098389
<b>Lock with Screws - Tandem 24 (October 2013 - present)</b>			
	<b>Note:</b> Use for unit dimension heights greater than 39.500" and less than or equal to 46.125".	<b>Left</b>	<b>Right</b>
		1351435	1351436
<b>Lock with Screws - Triple 30 (October 2013 - present)</b>			
	<b>Note:</b> Use for unit dimension heights greater than 46.125" and less than or equal to 51.875".	<b>Left</b>	<b>Right</b>
		9098390	9098391
<b>Lock with Screws - Triple 36 (October 2013 - present)</b>			
	<b>Note:</b> Use for unit dimension heights greater than 51.875" and less than or equal to 58.625".	<b>Left</b>	<b>Right</b>
		1361898	1361896
<b>Lock with Screws - Triple 42 (October 2013 - present)</b>			
	<b>Note:</b> Use for unit dimension heights greater than 58.625" and less than or equal to 65.375".	<b>Left</b>	<b>Right</b>
		9098392	9098393
<b>Lock with Screws - Triple 48 (October 2013 - present)</b>			
	<b>Note:</b> Use for unit dimension heights greater than 65.375" and less than or equal to 71.250".	<b>Left</b>	<b>Right</b>
		9098394	9098395
<b>Lock with Screws - Quad 55 (October 2016 - present)</b>			
	<b>Note:</b> Use for unit dimension heights greater than 71.250" and less than or equal to 77.250".	<b>Left</b>	<b>Right</b>
		9152127	9152128
<b>Lock with Screws - Quad 60 (October 2016 - present)</b>			
	<b>Note:</b> Use for unit dimension heights greater than 77.250" and less than or equal to 83.250".	<b>Left</b>	<b>Right</b>
		9152129	9152130
<b>Lock with Screws - Quad 68 (October 2016 - present)</b>			
	<b>Note:</b> Use for unit dimension heights greater than 83.250" and less than or equal to 89.250".	<b>Left</b>	<b>Right</b>
		9152131	9152132
<b>Lock with Screws - Quad 74 (October 2016 - present)</b>			
	<b>Note:</b> Use for unit dimension heights greater than 89.250" and less than or equal to 95.250".	<b>Left</b>	<b>Right</b>
		9152133	9152134

## Hardware

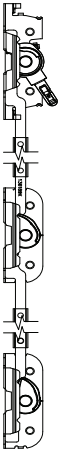
<b>Locks (2008 - October 2013)</b>			
<b>Lock with Screws - Single (2008 -October 2013)</b>			
	<b>Note:</b> Use for unit dimension heights of 29.25" or less.  View keeper in hardware section <a href="#">page 25</a> .	<b>Left</b>	<b>Right</b>
		1351433	1351434
<b>Lock with Screws - Tandem 12 (2008 -October 2013)</b>			
	<b>Note:</b> Use for unit dimension heights greater than 29.25" and less than or equal to 41.875".	<b>Left</b>	<b>Right</b>
		1361894	1361895
<b>Lock with Screws - Tandem 24 (2008 -October 2013)</b>			
	<b>Note:</b> Use for unit dimension heights greater than 41.875" and less than or equal to 53.25".	<b>Left</b>	<b>Right</b>
		1351435	1351436
<b>Lock with Screws - Triple 36 (2008 -October 2013)</b>			
	<b>Note:</b> Use for unit dimension heights greater than 53.25".	<b>Left</b>	<b>Right</b>
		1361898	1361896

# A-Series Casement & Picture Windows (2008 to Present)

Standard, Transom and Picture Windows

## Hardware

### Lock Components

#### Lock Handle - Traditional & Contemporary

	<p><b>Note:</b> Use same lock handle for traditional and contemporary style.</p> <p>Stone, white, black and gold dust handles not available separately. Replace with complete hardware set <a href="#">page 49</a>.</p>	<b>Finish</b>	<b>Order No.</b>
		Bright Brass	9016064
		Satin Nickel	9016065
		Distressed Nickel	9016071
		Oil Rubbed Bronze	9016066
		Antique Brass	9016067
		Brushed Chrome	9016068
		Polished Chrome	9016069
		Distressed Bronze	9016070

#### Keeper Kit No. 3 [page 22](#) and [page 23](#)

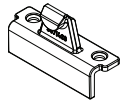
	<p><b>Kit Includes:</b> (1) Keeper (2) Screws</p> <p>View lock in hardware section <a href="#">page 52</a>.</p>	<b>Gray</b>
		9019485

#### Screw - Keeper

	<p><b>Note:</b> #7 X 1 1/16 XTYPE 17 430 SS</p>	<b>Order No.</b>
		9177142

#### Lock Bezel - Traditional & Contemporary

	<p><b>Note:</b> Black and gold dust bezels not available separately. Replace with complete hardware set <a href="#">page 49</a>.</p>	<b>Finish</b>	<b>Order No.</b>
		Bright Brass	1361547
		Satin Nickel	1361558
		Distressed Nickel	1300092
		Oil Rubbed Bronze	1300032
		Antique Brass	1300098
		Brushed Chrome	1300037
		Polished Chrome	1361549
		Distressed Bronze	1300083
		White	1351443
Stone	1351444		

## Hardware

Installation Kit		
Installation Kit - A Series Windows - without flange		
	<b>Kit Includes:</b> (28) Installation screws (16) Installation shims 1/32" (48) Installation shims 1/16" (28 feet) 3/8" Backer rod	<b>Order No.</b> 9078295
Installation Kit - Windows		
<b>Note:</b> Used for rectangular openings up to 46" x 72". See <a href="#">Installation Guide 9080775</a> .		
	<b>Kit Includes:</b> (20 feet) Backer rod (64) Shims 1/16" (54) Fasteners 1 1/2" nails (24 feet) Self-Adhering flashing tape (5 feet) Flexible sill flashing tape (1) Insulating foam- 12 oz. can (1) Sealant - 10.1 oz. tube Installation guide	<b>Order No.</b> 9080773

Installation Material				
Formable Sill Flashing				
<p><b>FORMABLE SILL</b></p>		Size	Order No.	
		25'	9105776	
		75'	9105777	
Straight Flashing				
<p><b>75 FT ROLL</b></p>		Size	Order No.	
		75'	9105778	
Silicone Sealant				
		Color	Type	Order No.
		Clear	DC794F	9014182

# A-Series Casement & Picture Windows (2008 to Present)

Standard, Transom and Picture Windows

## Hardware

### Optional Hardware

#### Opening Control Device Kit

	<b>Kit Includes:</b> (1) Track assembly (1) Extension arm assembly (1) Push button packet (1) Screw packet (1) Safety card <a href="#">Accessory Guide 9052526</a>	<b>Color</b>	<b>Left</b>	<b>Right</b>
		Stone	9051706	9051704
		White	9051705	9051703
		Black	9152274	9152275

#### Opening Control Device / Installation Kit

	<b>Kit Includes:</b> (1) Drill fixture (1) Drill bit (1) Screw	<b>Order No.</b>
		9051887

#### Opening Control Device / Track and Arm Kit

	<b>Kit Includes:</b> (1) Track assembly (1) Extension arm (5) Screws - 6 x 3/4" PH SMS SS18-8	<b>Left</b>	<b>Right</b>
		9053850	9053849

#### Opening Control Device / Screw Pack

	<b>Pack Includes:</b> (1) Screw - 7 x 7/8" PH PH TYP A (5) Screws - 6 x 3/4" PH SMS SS18-8	<b>Color</b>	<b>Order No.</b>
		Stone	9051889
		White	9051543
		Black	9152270

#### Opening Control Device / Release Button Kit

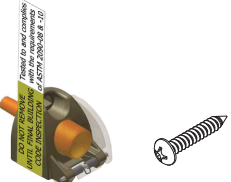
	<b>Kit Includes:</b> (1) Release button (1) Screw - 7 x 7/8" PH PH TYP A	<b>Color</b>	<b>Order No.</b>
		Stone	9053848
		White	9053847
		Black	9152273

**Fasteners**

<b>Screw - Operator</b>		
	<b>Note:</b> Used on both split arm and straight arm operators.	<b>Order No.</b> 1361961
<b>Screw - Hinge</b>		
	<b>Note:</b> Used to secure hinge.	<b>Order No.</b> 9066673
	<b>Description</b> 3/4 X #7 18-8SS PH FHUC TYPE 17	
<b>Screw - Dummy 90</b>		
	<b>Description</b> 1/2 X 8	<b>Order No.</b> 1351346
<b>Screw - Lock</b>		
		<b>Order No.</b> 1361962
<b>Screw</b>		
	<b>Description</b> 1 1/2 X 7 302 SST FLAT HEAD TYPE 17	<b>Order No.</b> 1361942
<b>Screw</b>		
	<b>Description</b> 1 1/16 X 7 430 SST FLAT HEAD TYPE 17	<b>Order No.</b> 9177142
<b>Screw</b>		
	<b>Description</b> 5/8 X 7 302 SST FL TRUSS HD	<b>Order No.</b> 1361938
<b>Screw</b>		
	<b>Description</b> 5/8 X 7 430 SST FLAT HEAD TYPE 17	<b>Order No.</b> 1361939
<b>Screw</b>		
	<b>Description</b> 5/8 X 8 302 SST FILST HD	<b>Order No.</b> 1361948
<b>Screw</b>		
	<b>Description</b> 7/8 X 7 430 SST FL TRUSS HD TYPE 17	<b>Order No.</b> 1361945
<b>Screw</b>		
	<b>Description</b> 8-18 X 9/16 PH SP DOME 430 SS DORR TYPE 17	<b>Order No.</b> 1351351

# A-Series Casement & Picture Windows (2008 to Present)

Standard, Transom and Picture Windows

## Frames

### Frames

#### Frame Assembly - Standard Windows

**Note:**

See current frame [Product Details](#).

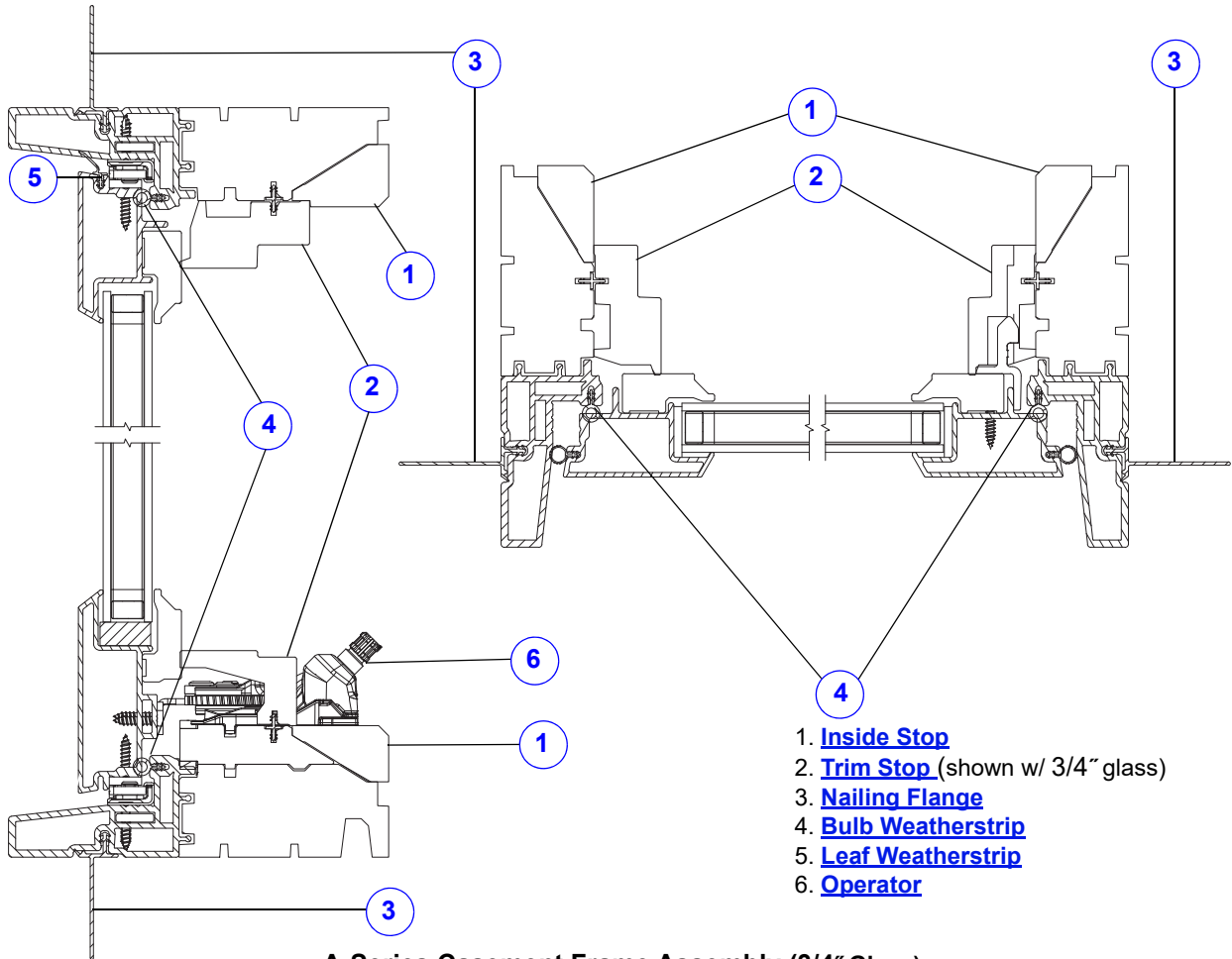

**A-Series Casement Frame Assembly (3/4" Glass)**

## Frames

### Frame - Standard Window

**Note:**

Replacement frames are made to order. Frame ships with trim stops. Clear coat finish can be applied on all six species shown. See iQ+ for additional detail. See current frame [Product Details](#).

To order, state:

1. **Unit or frame size** (ACW XXXX or frame W X H dimensions)
2. **Glazing Type**
3. **Product ID** (from product label), see [Service Guide 9051877](#).

### Frame - Standard Window

Exterior color options



Interior species/finish/color options

Unfinished or clear coat.



Shown on pine. Available on pine, maple and oak only.



Available with pine and maple only.

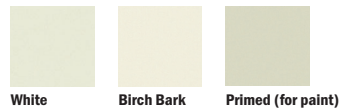

See your Andersen dealer for details.





# A-Series Casement & Picture Windows (2008 to Present)

Standard, Transom and Picture Windows

## Frames

### Frame Assembly - Picture Windows

**Note:**

See current frame [Product Details](#).

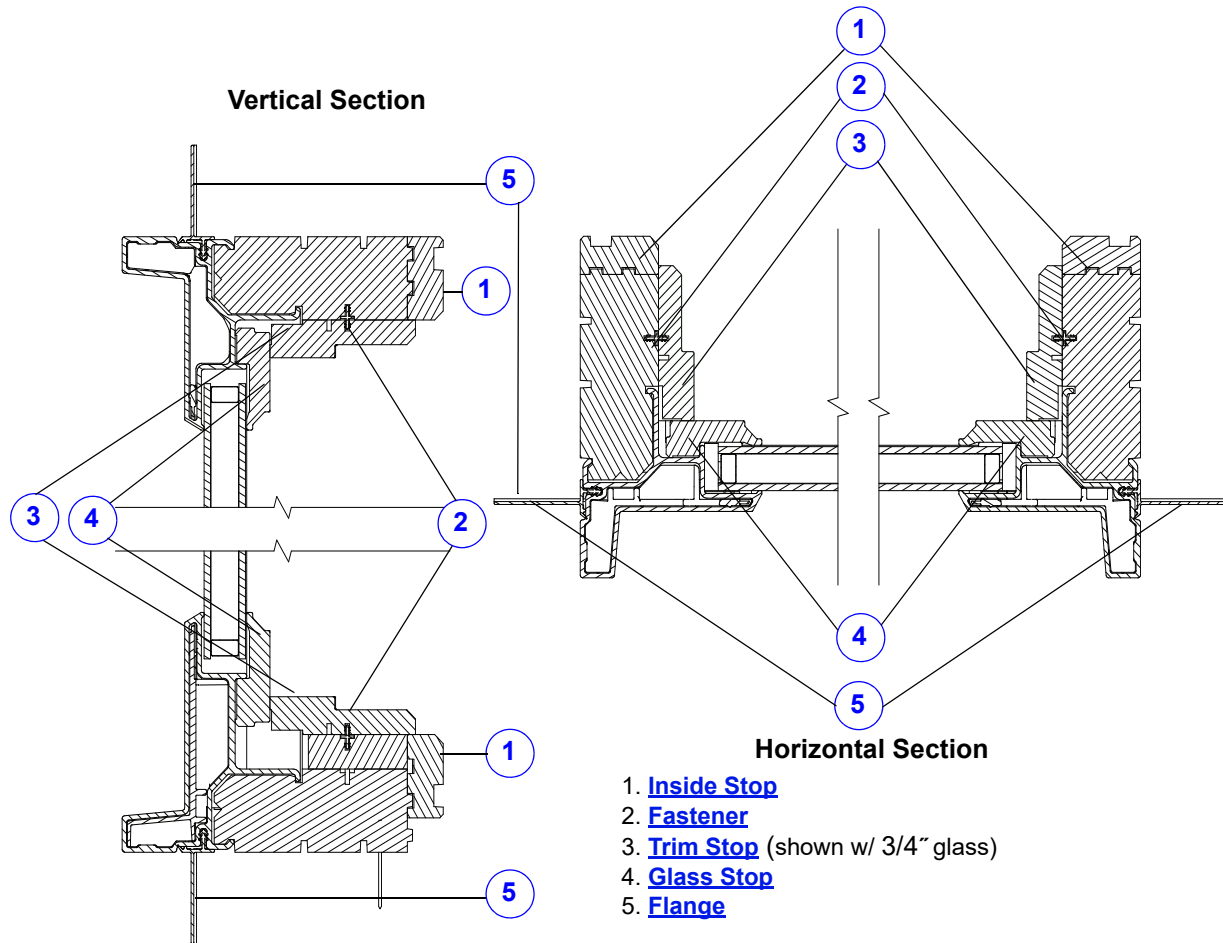

**A-Series Casement Picture Window Frame Assembly (3/4" Glass)**

## Frames

### Frame - Picture Window

**Note:**

Replacement frames are made to order. Frame ships with trim stops. See current frame [Product Details](#).

To order, state:

1. Unit or frame size (APW XXXX or frame W X H dimensions)
2. Glazing Type
3. Product ID (from product label), see [Service Guide 9051877](#).

### Frame - Picture Window

Exterior color options



Interior species/finish/color options

Unfinished or clear coat.



Shown on pine. Available on pine, maple and oak only.



Available with pine and maple only.

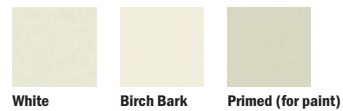

See your Andersen dealer for details.



# A-Series Casement & Picture Windows (2008 to Present)

Standard, Transom and Picture Windows

## Frames

### Stops - Venting and Stationary Windows

**Note:**

See [Service Guide 9044186](#) for sill stop replacement. Vintage stops shown for identification purposes. Current stop shown will ship. Clear coat finish can be applied on all six species shown. See iQ+ for additional detail.

Interior species/finish/color options



Shown on pine. Available on pine, maple and oak only.



Available with pine and maple only.



See your Andersen dealer for details.



## Frames

Stop - Trim / Sill / Venting and Stationary Window		
<b>3/4" Glass</b>	<b>1" Glass</b>	<p><b>Note:</b> Replacement trim stops are made to order.</p> <p><i>To order, state:</i></p> <ol style="list-style-type: none"> <li><b>Description of Part (Trim Stop - Sill)</b></li> <li><b>RH, LH or Stationary</b></li> <li><b>Split Arm or Straight Arm</b></li> <li><b>Interior Species/Finish/Color (see <a href="#">page 61</a>)</b></li> <li><b>Glazing Type</b></li> <li><b>Quantity</b></li> <li><b>Product ID (from product label), see <a href="#">Service Guide 9051877</a></b></li> </ol>
<i>2008 - present</i>	<i>January 2016 - present</i>	

Stop - Trim / Head / Venting and Stationary Window		
<b>3/4" Glass</b>	<b>1" Glass</b>	<p><b>Note:</b> Replacement trim stops are made to order.</p> <p><i>To order, state:</i></p> <ol style="list-style-type: none"> <li><b>Description of Part (Trim Stop - Head)</b></li> <li><b>Interior Species/Finish/Color (see <a href="#">page 61</a>)</b></li> <li><b>Glazing Type</b></li> <li><b>Quantity</b></li> <li><b>Product ID (from product label), see <a href="#">Service Guide 9051877</a></b></li> </ol>
<i>2008 - September 2012</i>	<i>October 2012 - present</i>	

Stop - Trim / Lock Side / Venting Window		
<b>3/4" Glass</b>	<b>1" Glass</b>	<p><b>Note:</b> Replacement trim stops are made to order.</p> <p><i>To order, state:</i></p> <ol style="list-style-type: none"> <li><b>Description of Part (Trim Stop - Lock Side)</b></li> <li><b>RH or LH</b></li> <li><b>Interior Species/Finish/Color (see <a href="#">page 61</a>)</b></li> <li><b>Glazing Type</b></li> <li><b>Quantity</b></li> <li><b>Product ID (from product label), see <a href="#">Service Guide 9051877</a></b></li> </ol>
<i>2008 - September 2012</i>	<i>October 2012 - present</i>	

Stop - Trim / Hinge Side / Venting Window		
<b>3/4" Glass</b>	<b>1" Glass</b>	<p><b>Note:</b> Replacement trim stops are made to order.</p> <p><i>To order, state:</i></p> <ol style="list-style-type: none"> <li><b>Description of Part (Trim Stop - Hinge Side)</b></li> <li><b>RH or LH</b></li> <li><b>Interior Species/Finish/Color (see <a href="#">page 61</a>)</b></li> <li><b>Glazing Type</b></li> <li><b>Quantity</b></li> <li><b>Product ID (from product label), see <a href="#">Service Guide 9051877</a></b></li> </ol>
<i>2008 - September 2012</i>	<i>October 2012 - present</i>	

# A-Series Casement & Picture Windows (2008 to Present)

Standard, Transom and Picture Windows

## Frames

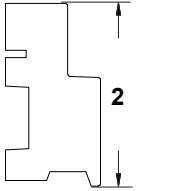
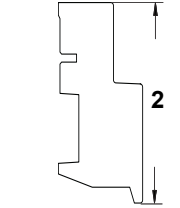
Stop - Trim / Stationary Side / Stationary Window		
3/4" Glass	1" Glass	<b>Note:</b> Replacement trim stops are made to order.  To order, state: <ol style="list-style-type: none"> <li>1. Description of Part (Trim Stop - Stationary Side)</li> <li>2. Interior Species/Finish/Color (see <a href="#">page 61</a>)</li> <li>3. Glazing Type</li> <li>4. Quantity</li> <li>5. Product ID (from product label), see <a href="#">Service Guide 9051877</a></li> </ol>
		
2008 - September 2012	October 2012 - present	January 2016 - present

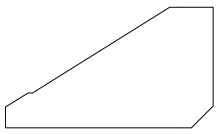
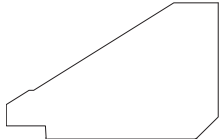
Stop - Inside / Head / Venting and Stationary Window		
3/4" Glass	1" Glass	<b>Note:</b> Replacement inside stops are made to order.  To order, state: <ol style="list-style-type: none"> <li>1. Description of Part (Inside Stop - Head)</li> <li>2. Interior Species/Finish/Color (see <a href="#">page 61</a>)</li> <li>3. Glazing Type</li> <li>4. Quantity</li> <li>5. Product ID (from product label), see <a href="#">Service Guide 9051877</a></li> </ol>
		
2008 - September 2012	October 2012 - present	January 2016 - present

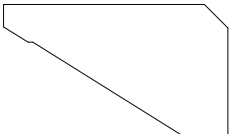
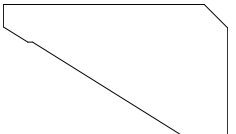
Stop - Inside / Side and Sill / Venting and Stationary Window		
3/4" Glass	1" Glass	<b>Note:</b> Replacement inside stops are made to order. Side stop handed as viewed from exterior.  To order, state: <ol style="list-style-type: none"> <li>1. Description of Part (Inside Stop - Side or Sill)</li> <li>2. Interior Species/Finish/Color (see <a href="#">page 61</a>)</li> <li>3. Glazing Type</li> <li>4. Quantity</li> <li>5. Product ID (from product label), see <a href="#">Service Guide 9051877</a></li> </ol>
		
2008 - present	January 2016 - present	

## Frames

### Stops - Picture Windows

Interior species/finish/color options



Shown on pine. Available on pine, maple and oak only.



Available with pine and maple only.

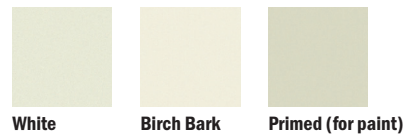

See your Andersen dealer for details.

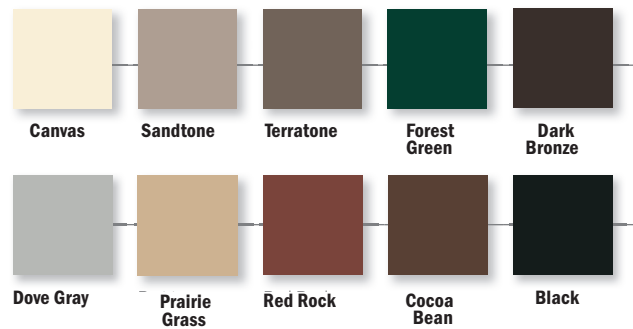

# A-Series Casement & Picture Windows (2008 to Present)

Standard, Transom and Picture Windows

## Frames

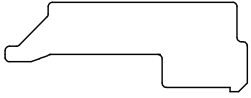
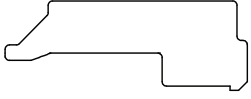
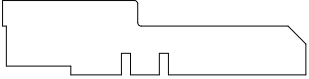
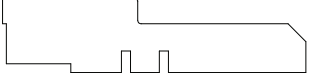
Glass Stop - Picture Window / Head and Sill	
	<p><b>Note:</b> Replacement glass stops are made to order.</p> <p><i>To order, state:</i></p> <ol style="list-style-type: none"><li>1. <b>Description of Part (Glass Stop - Head and Sill)</b></li><li>2. <b>Interior Species/Finish/Color</b> (see <a href="#">page 64</a>)</li><li>3. <b>Quantity</b></li><li>4. <b>Product ID</b> (from product label), see <a href="#">Service Guide 9051877</a></li></ol>
Glass Stop - Picture Window / Side	
	<p><b>Note:</b> Replacement glass stops are made to order. Handed as viewed from exterior.</p> <p><i>To order, state:</i></p> <ol style="list-style-type: none"><li>1. <b>Description of Part (Glass Stop - Side)</b></li><li>2. <b>RH or LH</b></li><li>3. <b>Interior Species/Finish/Color</b> (see <a href="#">page 64</a>)</li><li>4. <b>Quantity</b></li><li>5. <b>Product ID</b> (from product label), see <a href="#">Service Guide 9051877</a></li></ol>
Trim Stop - Picture Window / Head and Sill	
	<p><b>Note:</b> Replacement trim stops are made to order.</p> <p><i>To order, state:</i></p> <ol style="list-style-type: none"><li>1. <b>Description of Part (Trim Stop - Head and Sill)</b></li><li>2. <b>Interior Species/Finish/Color</b> (see <a href="#">page 64</a>)</li><li>3. <b>Quantity</b></li><li>4. <b>Product ID</b> (from product label, see <a href="#">Service Guide 9051877</a>)</li></ol>
Trim Stop - Picture Window / Side	
	<p><b>Note:</b> Replacement trim stops are made to order. Handed as viewed from exterior.</p> <p><i>To order, state:</i></p> <ol style="list-style-type: none"><li>1. <b>Description of Part (Trim Stop- Side)</b></li><li>2. <b>RH or LH</b></li><li>3. <b>Interior Species/Finish/Color</b> (see <a href="#">page 64</a>)</li><li>4. <b>Quantity</b></li><li>5. <b>Product ID</b> (from product label), see <a href="#">Service Guide 9051877</a></li></ol>

## Frames

### Inside Stop - Picture Window / Head and Sill

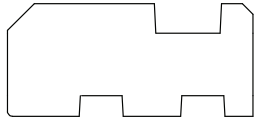

**Note:**  
Replacement inside stops are made to order.

*To order, state:*

1. **Description of Part (Inside Stop - Head and Sill)**
2. **Interior Species/Finish/Color** (see [page 64](#))
3. **Quantity**
4. **Product ID** (from product label), see [Service Guide 9051877](#)

### Inside Stop - Picture Window / Side

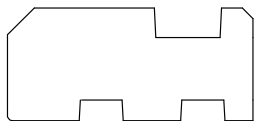

**Note:**  
Replacement inside stops are made to order. Handed as viewed from exterior.

*To order, state:*

1. **Description of Part (Inside Stop - Side)**
2. **RH or LH**
3. **Interior Species/Finish/Color** (see [page 64](#))
4. **Quantity**
5. **Product ID** (from product label), see [Service Guide 9051877](#)



# A-Series Casement & Picture Windows (2008 to Present)

Standard, Transom and Picture Windows

## Frames

### Extension Jamb

**Note:**

See latest [detail](#).

Size	Dim A
5 1/4	0.719
6 9/16	2.032
7 1/8	2.594

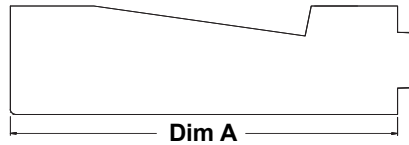

Unit No.	Length	Natural Wood			Prefinished Interior White (Painted)			Vinyl Wrapped White
		5 1/4" Wall	6 9/16" Wall	7 1/8" Wall	5 1/4" Wall	6 9/16" Wall	7 1/8" Wall	6 9/16" Wall
<b>TW96</b>	96	1636627	1636637	1636647	1694669	1694628	1694711	N/A
<b>TW144</b>	144	1636628	1636638	1636648	1694670	1694629	1694712	N/A

## Frames

### Stools

**Note:**

Casing is offset  $7/32$  from edge of stool. Custom sized stools available as configured items.

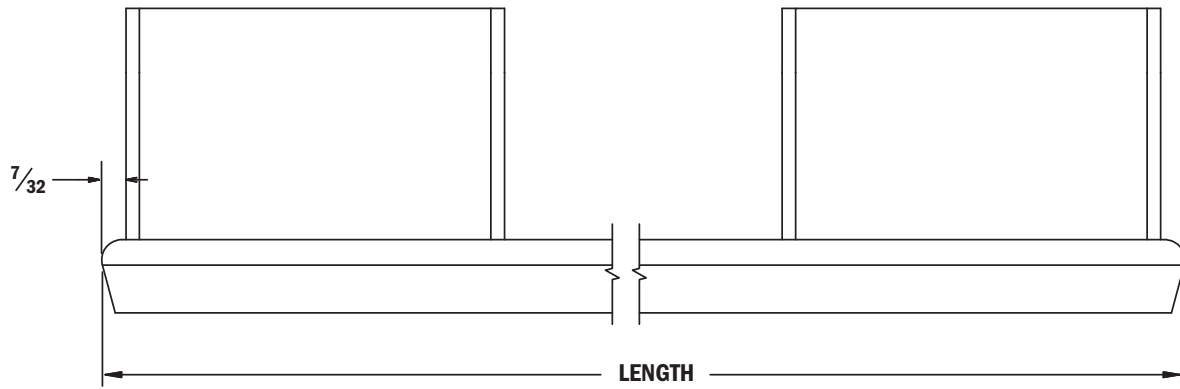

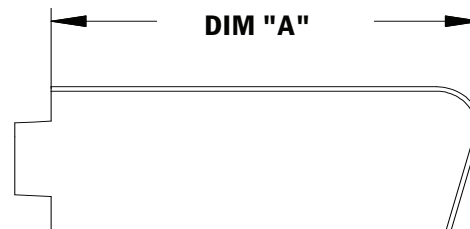

Depth	Dim A
4 $\frac{9}{16}$	1 $\frac{55}{64}$
5 $\frac{1}{4}$	2 $\frac{35}{64}$
6 $\frac{9}{16}$	3 $\frac{55}{64}$
7 $\frac{1}{8}$	4 $\frac{27}{64}$

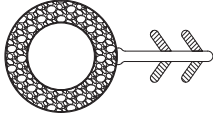
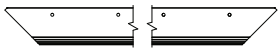

# A-Series Casement & Picture Windows (2008 to Present)

Standard, Transom and Picture Windows

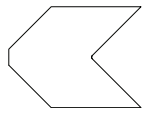
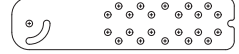
Frame Parts			
Weatherstrip Kit			
<b>Note:</b> Sits vertically on the side jambs and horizontally on the head and sill.			
	<b>Kit Includes:</b> (27') Weatherstrip <a href="#">Service Guide 9011006</a>	<b>Beige</b>	
		9019482	
Nailing Flange Ref. No. 13 <a href="#">page 70</a>			
		<b>For Unit Dimensions Up to</b>	<b>Order No.</b>
		37 1/4	3030002
		59 1/4	3030004
		95 1/4	9021961
Stop Fastener			
	<b>Note:</b> (12) Fasteners	<b>Order No.</b>	
		9019521	
Flange Corner Seal			
	<b>Note:</b> Black in color, ships as a quantity of two (2) per sheet. Adhesive back	<b>Order No.</b>	
		3030005	
Clip - Installation Kit with Screws			
		<b>Quantity</b>	<b>Order No.</b>
		14 clips	6 3/8 x 1 1/2

## Joining Components

---

## Joining Components

---

### Reinforced (Fiberglass) Joining Kit Exploded View

**Note:**

See (1-Way) [Installation Guide 9161599](#) and (1-Way Assembly in Opening) [Installation Guide 9161601](#).

See (2-Way) [Installation Guide 9161600](#).

# A-Series Casement & Picture Windows (2008 to Present)

Standard, Transom and Picture Windows

## Joining Components

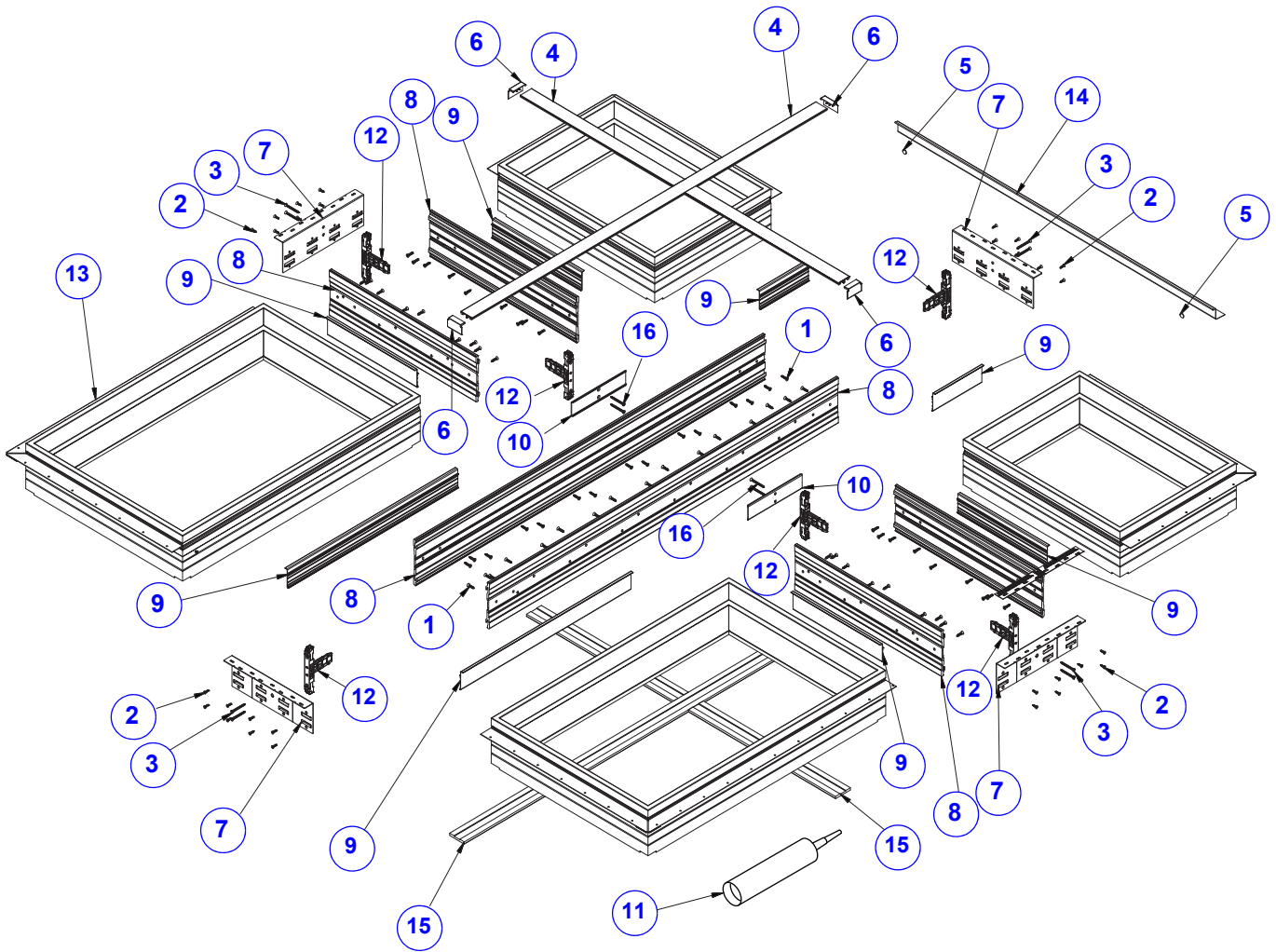

1. [Joining Plate Screw](#)
2. [Gusset Plate Screw](#)
3. [Locking Plug Screw](#)
4. [Exterior Trim Strip](#)
5. [Felt Pad](#)
6. [End Cap](#)
7. [Gusset Plate](#)
8. [Joining Plate](#)



9. [Joining Plate Alignment Spacer](#)
10. [Intersection Bracket \(2/Join\)](#)
11. [Sealant](#)
12. [Locking/Sealing Plug](#)
13. [Flange](#)
14. [Drip Cap](#)
15. [Interior Casing](#)
16. [Intersection Screw \(Long\)](#)

## Joining Components

### Reinforced (Fiberglass) Joining Kits

**Kit Includes:**

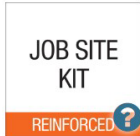
- (2) Gusset plates
- (2) Joining plates
- (1) Joining plate alignment spacer
- (1) Exterior trim strip
- (2) Locking/sealing plugs
- (2) Mull end caps
- (1) Tube of Sealant
- Hardware pack(s) (quantities vary depending on configuration)

		<b>Note:</b> Configured with multiple exterior/interior/flange options. Drip cap needs to be ordered separately. See (1-Way) <a href="#">Installation Guide 9161599</a> and (2-Way) <a href="#">Installation Guide 9161600</a> . See additional <a href="#">detail</a> .	<b>Length</b>	<b>Order No.</b>
 <b>JOB SITE KIT</b> REINFORCED 	 <b>DEALER KIT</b> REINFORCED			72"
Reinforced Join - Jobsite Assembled w/ Kit	Reinforced Join - Dealer Assembled w/ Kit		96"	Configured

# A-Series Casement & Picture Windows (2008 to Present)

Standard, Transom and Picture Windows

## Joining Components

### Reinforced (Fiberglass) Joining Kit Components

#### Inside Casing - 2 1/8"

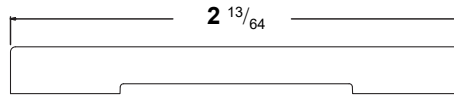

Finish	96"			120"					
	PINE	MAPLE	OAK	PINE	MAPLE	OAK	CHERRY	MAHOGANY	DOUGLAS FIR
Unfinished	9067316	9064335	9064417	9068749	9068751	9068750	9140911	9140912	9140910
Clear Coat	9013183	9013187	9013185	9013184	9013188	9013186			
Cinnamon	9013207	9013211	9013209	9013208	9013212	9013210			
Mocha	9013195	9013199	9013197	9013196	9013200	9013198			
Primed	9013181	9055407	9040763	9013182	9040764	9055404			
Honey	9013201	9013205	9013203	9013202	9013206	9013204			
Russet	9013189	9013193	9013191	9013190	9013194	9013192			
Espresso	9013215	9013219	9013217	9013216	9013220	9013218			
Birch Bark (Bright White)	9013213	9055408	9040765	9013214	9040766	9055405			
<b>White</b>	9013179	9055406	9040761	9013180	9040762	9055403			
<b>Terratone</b>	9178875	9178857	9178866	9178830	9178848	9178839			
<b>Sandtone</b>	9178874	9178856	9178865	9178829	9178847	9178838			
<b>Forest Green</b>	9178881	9178863	9178872	9178836	9178854	9178845			
<b>Canvas</b>	9178873	9178855	9178864	9178828	9178846	9178837			
<b>Prairie Grass</b>									
<b>Cocoa Bean</b>	9178880	9178862	9178871	9178835	9178853	9178844			
<b>Dove Gray</b>	9178879	9178861	9178870	9178834	9178852	9178843			
<b>Red Rock</b>	9178878	9178860	9178869	9178833	9178851	9178842			
<b>Black</b>	9178876	9178858	9178867	9178831	9178849	9178840			
<b>Dark Bronze</b>	9178877	9178859	9178868	9178832	9178850	9178841			

## Joining Components

### Inside Casing - 2 3/4"

**Note:**

Used when a wide bottom rail (A-Series Casement or A-Series Awning) unit is mulled above other A-Series windows or doors.

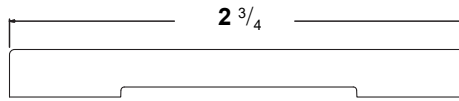

Finish	96"		
	Pine	Maple	Oak
Unfinished	9067323	9068753	9068752
White	9055372	9055385	9055394
Clear Coat	9055373	9055386	9055395
Cinnamon	9055374	9055387	9055396
Mocha	9055375	9055388	9055397
Primed	9055376	9055389	9055398
Honey	9055377	9055390	9055399
Russet	9055378	9055391	9055400
Espresso	9055379	9055392	9055401
Birch Bark (Bright White)	9055380	9055393	9055402



# A-Series Casement & Picture Windows (2008 to Present)

Standard, Transom and Picture Windows

## Joining Components

### Trim Strip Ref. No. 4 [page 70](#)

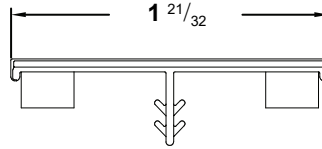

Color	10 ft Lineal (123 1/4")	12 ft Lineal (143 3/4")	31 (35 13/16")	68 (79 1/4")	611 (82 1/8")	80 (95 1/4")
White	2510101	N/A	9044058	2573492	2573496	2573488
Terratone	2640746	N/A	9044098	2640743	2640744	2640745
Sandtone	0903753	N/A	9044068	0903750	0903751	0903752
Forest Green	1262851	N/A	9044099	1262848	1262849	1262850
Canvas	9033574	N/A	9044078	9033578	9033579	9033577
Prairie Grass	By description	N/A	9044103	9044135	9044143	9044151
Cocoa Bean	By description	N/A	9044102	9044134	9044142	9044150
Dove Gray	By description	N/A	9044088	9044092	9044093	9044094
Red Rock	By description	N/A	9044100	9044132	9044140	9044148
Black	By description	N/A	9044101	9044133	9044141	9044149
Dark Bronze	9020917	N/A	9044104	9044136	9044144	9044152

### End Cap Ref. No. 6 [page 70](#)

**Note:**

3/2012 - Present vintage used on LVL and fiberglass kits. End caps from 11/20-2/2012 are not available, replace with current.

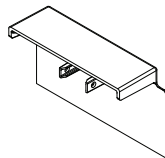
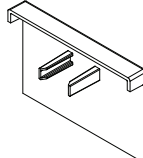
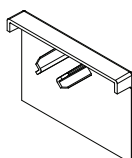
	Month/Year		
	3/2012 - Present	11/2010 - 2/2012	2008 - 10/2010
			
Color	Order No.	Order No.	Order No.
White	9043111	N/A	9034557
Terratone	9043119	N/A	9034565
Sandtone	9043110	N/A	9034556
Forest Green	9043118	N/A	9034564
Canvas	9043112	N/A	9034558
Prairie Grass	9043117	N/A	9034563
Cocoa Bean	9043116	N/A	9034562
Dove Gray	9043113	N/A	9034559
Red Rock	9043114	N/A	9034560
Black	9043115	N/A	9034561

## Joining Components

End Cap Ref. No. 6 <a href="#">page 70</a>			
Dark Bronze	9043120	N/A	9034566

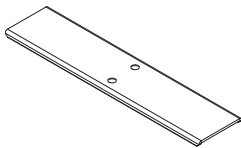
Bracket - FGL Intersection Ref. No. 10 <a href="#">page 70</a>	
	Order No. 9152243

Joining Plate - FGL Ref. No. 8 <a href="#">page 70</a>			
<b>Note:</b> Need two per mull. Cut to fit joining plates 1 1/2" shorter than the overall mull length or width.			
		Size	Order No.
		34 1/4"	9150659
		94 1/4"	9150660
		118 1/4"	9150661
		142 1/2"	9163966

Joining Plate Alignment Spacer - FGL Ref. No. 9 <a href="#">page 70</a>			
<b>Note:</b> Need one per unit jamb that is to be joined. Required length: Unit length - 10"			
		Size	Order No.
		88"	9160158
		136"	9163967

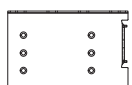
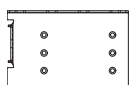
Half Gusset Plate - Assemble In Opening				
<b>Note:</b> Gusset required for rough opening mulling.				
 Type A	 Type B		Type	
			A	9173227
			B	9173228

Gusset Plate Ref. No. 7 <a href="#">page 70</a>			
---	--	--	--

# A-Series Casement & Picture Windows (2008 to Present)

Standard, Transom and Picture Windows

## Joining Components

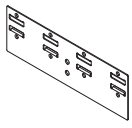
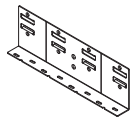
 <p><b>Flat</b></p>	 <p><b>Flanged</b></p>		<b>Type</b>	<b>Size</b>	<b>Order No.</b>
			Flanged	12"	3020001
			Flat		9023933
			Flanged	18"	3020004
	Flat	9023934			

### Gasket - Assemble In Opening

**Note:**

Two gaskets required for each Fiberglass (Easy Connect) join.

		<b>Order No.</b>
		9123317

### End Plug

**Note:**

Required for rough opening mulling.

		<b>Order No.</b>
		9173229

### Locking/Sealing Plug - FGL (November 5, 2018 to Present) Ref. No. 12 [page 70](#)

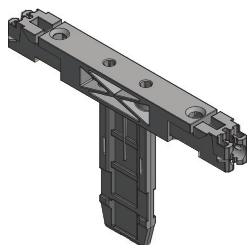
		<b>Order No.</b>
		9177451

## Joining Components

### Miscellaneous Joining Components/Fasteners

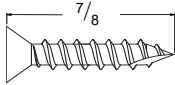
Screw Package - 7/8" FGL Screw Ref. No. 1 <a href="#">page 70</a>			
	<b>Package Includes:</b> Screw, 10-12 x 7/8 PH FL Type 17	<b>Qty</b>	<b>Order No.</b>
		52	9159384
		1	9159383

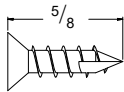
Screw - Gusset Plate / Intersection Bracket (Short) Ref. No. 2 <a href="#">page 70</a>			
	<b>Description</b> 5/8 X #8	<b>Qty</b>	<b>Order No.</b>
		1	3020011
		16	9017649

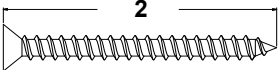
Screw - Gusset Plate / Intersection Bracket (Long) Ref. No. 3 & 16 <a href="#">page 70</a>		
	<b>Description</b>	<b>Order No.</b>
	2 X #10	9017654

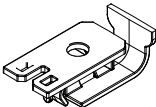
End Plug - Non-Reinforced		
		<b>Order No.</b>
		9043109

Trim Strip Receiver - Non-Reinforced			
		<b>Length</b>	<b>Order No.</b>
		144"	9043374

## A-Series Casement & Picture Windows (2008 to Present)

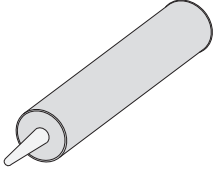
Installation Sealant Ref. No. 11 <a href="#">page 70</a>		
		<b>Color</b>
		<b>Order No.</b>
		White
		9105774
		Sandtone
		9160293
		Canvas
		9160299
		Terratone
		9160294
		Forest Green
		9160296
	Prairie Grass	
	9160297	
	Dove Gray	
	9160298	
	Dark Bronze	
	9160292	
	Cocoa Bean	
	9160300	
	Red Rock	
	9160301	
	Black	
	9160295	

Felt Pad - Black Ref. No. 6 <a href="#">page 70</a>		
	<b>Description</b>	<b>Order No.</b>
	1/2" diameter X 1/16" thick	By Description

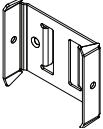
Slide Clip - Non-Reinforced		
		<b>Order No.</b>
		3020005

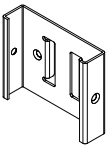
Receiver Clip - Non-Reinforced		
		<b>Order No.</b>
		3020012

## Joining Components

### Universal Drip Cap - Continuous

**Note:**

Use on side-by-side or vertical joins mullied at the factory or distributor. Consists of 24 gauge aluminum material.

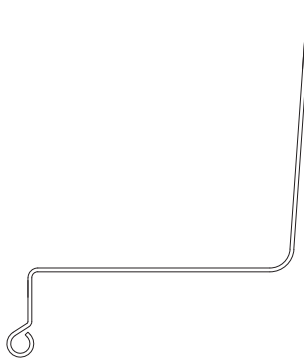

	72"			120"			151 1/2"	
	Package Quantity			Package Quantity			Package Quantity	
	1	10	40	1	10	40	1	10
<b>White</b>	2222525	2222526	2222527	2222546	2222547	2222548	2222555	2222556
<b>Terratone</b>	2222528	2222529	NA	2222549	2222550	NA	2222557	2222558
<b>Sandtone</b>	2222530	2222531	NA	2222551	2222552	NA	2222559	2222560
<b>Forest Green</b>	2222532	2222533	NA	2222553	2222554	NA	2222561	2222562
<b>Canvas</b>	9003116	9003117	NA	9003126	9003127	NA	9003130	9003131
<b>Prairie Grass</b>	9003565	9003566	NA	9003573	9003574	NA	9003581	9003582
<b>Cocoa Bean</b>	9003118	9003119	NA	9003128	9003129	NA	9003132	9003133
<b>Dove Gray</b>	9003563	9003564	NA	9003571	9003572	NA	9003579	9003580
<b>Red Rock</b>	9003559	9003560	NA	9003567	9003568	NA	9003575	9003576
<b>Black</b>	9003561	9003562	NA	9003569	9003570	NA	9003577	9003578
<b>Dark Bronze</b>	9020502	9020503	NA	9020504	9020505	NA	9020506	9020507

# A-Series Casement & Picture Windows (2008 to Present)

Service Replacement

## Service Replacement Only Parts

Service Replacement

## Service Replacement Only Parts

### Service Replacement Only Parts

**Note:**

This section is specifically designed for parts that should only be ordered if a Field Service Manager/Service Provider has requested them to be ordered or if the customer agrees to also pay for a non-warranty repair/replace service job (subject to availability) for these parts to be installed. We do not recommend anyone other than a trained AW employee or Service Provider install these parts due to the complexity of installation, modifications required for installation and/or requirement of special tools.

### Exterior Grilles - Permanently Applied / Taped

#### Exterior Grilles - Taped / Chamfer A

**Note:**

Permanently applied grilles can only be ordered by Andersen Territory Service Representatives, Andersen Service Dealers and Providers.

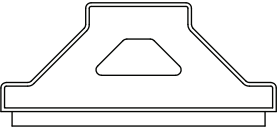

	Color	Length	$\frac{3}{4}''$	$\frac{7}{8}''$	$1 \frac{1}{8}''$	$2 \frac{1}{4}''$
	White	96	1284329	1284330	1284331	1284332
Terratone	96	9011971	9011972	9011973	9011974	
Sandtone	96	1284325	1284326	1284327	1284328	
Forest Green	96	9011967	9011968	9011969	9011970	
Canvas	96	1284357	1284358	1284359	1284360	
Prairie Grass	96	9011991	9011992	9011993	9011994	
Cocoa Bean	96	9011987	9011988	9011989	9011990	
Dove Gray	96	9011983	9011984	9011985	9011986	
Red Rock	96	9011975	9011976	9011977	9011978	
Black	96	9011979	9011980	9011981	9011982	
Dark Bronze	96	9020289	9020290	9020291	9020292	
Unfinished	96	9011963	9011964	9011965	9011966	

**Interior Grilles - Taped / Chamfer A**

**Note:**

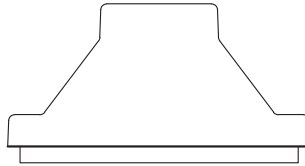
Permanently applied grilles can only be ordered by Andersen Territory Service Representatives, Andersen Service Dealers and Providers. Contact your local [Andersen Service Provider](#). ❌

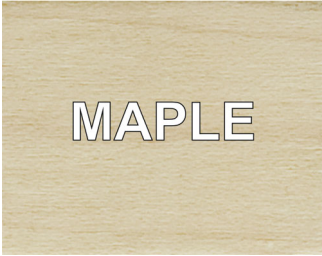

	Length	Pine			
		3/4"	7/8"	1 1/8"	2 1/4"
 <p>PINE</p>	22"	2321131	2321136	2321141	2321146
	34"	2321132	2321137	2321142	2321147
	44"	2321133	2321138	2321143	2321148
	60"	2321134	2321139	2321144	2321149
	84"	2321135	2321140	2321145	2321150
	Length	Oak			
		3/4"	7/8"	1 1/8"	2 1/4"
 <p>OAK</p>	22"	2321111	2321116	2321121	2321126
	34"	2321112	2321117	2321122	2321127
	44"	2321113	2321118	2321123	2321128
	60"	2321114	2321119	2321124	2321129
	84"	2321115	2321120	2321125	2321130
	Length	Maple			
		3/4"	7/8"	1 1/8"	2 1/4"
 <p>MAPLE</p>	22"	2321010	2321015	2321020	2321025
	34"	2321011	2321016	2321021	2321026
	44"	2321012	2321017	2321022	2321027
	60"	2321013	2321018	2321023	2321028
	84"	2321014	2321019	2321024	2321029



# A-Series Casement & Picture Windows (2008 to Present)

Service Replacement

## Service Replacement Only Parts

### Weatherstrip

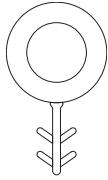
Weatherstrip - Replacement			
	<b>Note:</b> Ships as 21' length.	<b>Color</b>	<b>Order No.</b>
		Beige	9087679

## Service Replacement Only Parts

---

### Notes

---