

## What's in This Section

<b>Standard Windows</b> .....	<b>Page 3</b>
<b>Parts Illustration</b> .....	<b>3</b>
<b>Unit Sizes</b> .....	<b>4</b>
400 Series Product Label .....	4
Unit Size Chart - Arch Windows .....	5
Unit Size Chart - Circle Top and Arch Top Windows .....	7
<b>Product History</b> .....	<b>8</b>
Milestones .....	8
<b>Glass</b> .....	<b>9</b>
Glass Size Table .....	9
Glass .....	12
Glass Parts .....	13
<b>Grilles</b> .....	<b>14</b>
Interior Grilles - Colonial .....	14
Interior Grilles - Renaissance .....	24
Interior Grilles - Sunburst .....	29
Grille Fasteners .....	30
<b>Frames</b> .....	<b>31</b>
Frame Assembly .....	31
Stops .....	32
Flanges .....	33
Installation Kits for Standard and Impact Resistant Units .....	33
<b>Optional Components</b> .....	<b>35</b>
Inside Casing .....	35
Extension Jambs .....	36
Drywall Return Bead .....	38
Trim Parts .....	39
<b>Joining Components</b> .....	<b>40</b>
Narrow Mullion .....	40
Support Mullion .....	42
Reinforced Mull Joining Components - Steel .....	43
Reinforced Mull Joining Components - Aluminum .....	46
<b>Art Glass Components</b> .....	<b>48</b>
Art Glass .....	48
Art Glass Trim Stops .....	48
Art Glass Hardware .....	49

**Stormwatch™ Protection (Coastal Product) . . . . . Page 51**

**Frame (Impact Resistant) . . . . . 51**

        Installation Kits for Standard and Impact Resistant Units . . . . . 51

**Service Replacement . . . . . Page 53**

**Service Replacement Only Parts . . . . . 53**

        Service Replacement Only Parts . . . . . 53

        Exterior Grilles - HDN . . . . . 53

# 400 Series Arch Windows (1989 to Present)

Standard Windows

Parts Illustration

## Parts Illustration

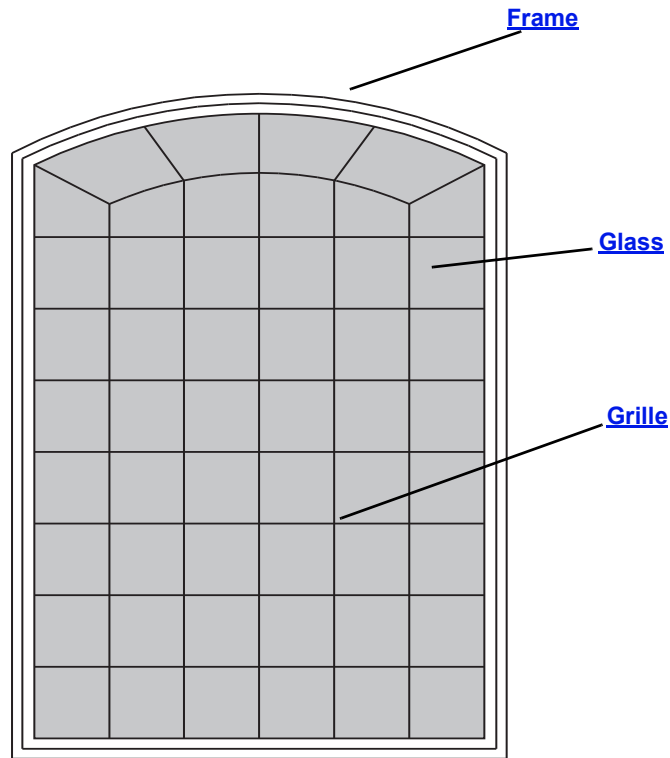

Manufactured 1989 to Present

**Arch Window Parts**

*Unit viewed from exterior.*

## Unit Sizes

---

### 400 Series Product Label

**Note:**

Some Arch windows will have an identification label **or** glass etching containing a unique Product ID. The Product ID on Arch windows will be located at the bottom of the window frame or etched into the glass. See [Service Guide 9051877](#))The Product ID may be up to 14 digits long (excluding hyphens), depending on the age of the unit. Replacement parts will also get their own unique Product ID. When ordering replacement parts, providing the Product ID ensures that replacement parts match the specifications.

# 400 Series Arch Windows (1989 to Present)

Standard Windows

## Unit Sizes

### Unit Size Chart - Arch Windows

**Note:**

Unit Dimension refers to overall outside-to-outside frame. Unobstructed Glass refers to visible glass dimensions. Numbers in parentheses are metric measurements.

See [Measuring Visible Glass Video](#).

CHORD HEIGHT	3 1/4" (83)	4 21/32" (118)	4 13/16" (122)	6 7/16" (164)	7 1/16" (179)	7 13/16" (198)	9 7/16" (240)	12 5/8" (321)	13 13/32" (341)	
Radius	2' (610)	2' (610)	3' (914)	4' (1219)	5' (1524)	5' (1524)	6' (1829)	8' (2438)	16' (4877)	
Unit Dimension	2'-0 1/8" (613)	2'-4 3/8" (721)	2'-11 15/16" (913)	4'-0" (1219)	4'-8 1/2" (1435)	4'-11 1/4" (1505)	5'-11 1/4" (1810)	7'-11 1/8" (2416)	11'-9" (3581)	
Minimum Rough Opg.	2'-0 5/8" (625)	2'-4 7/8" (733)	3'-0 1/2" (927)	4'-0 1/2" (1232)	4'-9" (1448)	4'-11 3/4" (1518)	5'-11 3/4" (1822)	7'-11 5/8" (2429)	11'-9 1/2" (3594)	
Unobstructed Glass	19 3/8" (492)	23 5/8" (600)	31 3/16" (792)	43 1/4" (1099)	51 3/4" (1314)	54 1/2" (1384)	66 1/2" (1689)	90 3/8" (2296)	136 1/4" (3461)	
See notes above for determining unit and rough opening heights	6" (152)	AFC106*	AFCW106*	AFCP3006*	AFC206*	AFCW206*	AFFW5006*	AFFW6006*	AFFW8006*	AFFW12006 AG
	12" (305)	AFC11*	AFCW11*	AFCP301*	AFC21*	AFCW21*	AFFW501*	AFFW601*	AFFW801*	AFFW1201 AG
	2'-0 1/8" (613)	AFC12	AFCW12	AFCP302	AFC22	AFCW22	AFFW502	AFFW602	AFFW802	AFFW1202 AG
	2'-11 15/16" (913)	AFC13	AFCW13 AG	AFCP303 AG	AFC23 AG	AFCW23 AG	AFFW503 AG	AFFW603 AG	AFFW803 AG	Colonial grille pattern (shown) is standard for the three sizes above. Sunburst and Renaissance can be ordered as custom grille patterns.
	3'-4 13/16" (1037)	AFC135 AG	AFCW135 AG	AFCP3035 AG	AFC235 AG	AFCW235 AG	AFFW5035 AG	AFFW6035 AG	AFFW8035 AG	
	4'-0" (1219)	AFC14	AFCW14 AG	AFCP304	AFC24	AFCW24	AFFW504	AFFW604	AFFW804	Specified equal light and custom patterns are also available. Not all grille patterns are available in all configurations.
4'-4 13/16" (1341)	AFC145 AG	AFCW145 AG	AFCP3045 AG	AFC245 AG	AFCW245 AG	AFFW5045 AG	AFFW6045 AG	AFFW8045 AG		

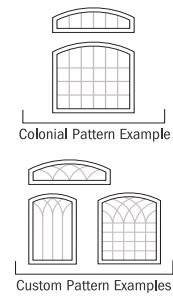

### Arch Window Unit Sizes

Unit viewed from exterior.

## Unit Sizes

<b>CHORD HEIGHT</b>	3 1/4" (83)	4 21/32" (118)	4 13/16" (122)	6 7/16" (164)	7 1/16" (179)	7 13/16" (198)	9 7/16" (240)	12 5/8" (321)
Radius	2' (610)	2' (610)	3' (914)	4' (1219)	5' (1524)	5' (1524)	6' (1829)	8' (2438)
Unit Dimension	2'-0 1/8" (613)	2'-4 3/8" (721)	2'-11 15/16" (913)	4'-0" (1219)	4'-8 1/2" (1435)	4'-11 1/4" (1505)	5'-11 1/4" (1810)	7'-11 1/8" (2416)
<b>Minimum Rough Opq.</b>	2'-0 5/8" (625)	2'-4 7/8" (733)	3'-0 1/2" (927)	4'-0 1/2" (1232)	4'-9" (1448)	4'-11 3/4" (1518)	5'-11 3/4" (1822)	7'-11 5/8" (2429)
Unobstructed Glass	19 3/8" (492)	23 5/8" (600)	31 3/16" (792)	43 1/4" (1099)	51 3/4" (1314)	54 1/2" (1384)	66 1/2" (1689)	90 3/8" (2296)

**Grille alignment with other Andersen® products.** All vertical arch window grille members were designed to be equally spaced. Vertical alignment may not coincide when units are transom joined. All horizontal grille members were designed to line up with corresponding casement sizes. Special order arch window grilles are available to achieve proper alignment.

Sizes on this page are shown with the Renaissance grille pattern.

Renaissance not available with Finelight® grilles.

Specified equal light and custom patterns are also available. Not all grille patterns are available in all configurations.

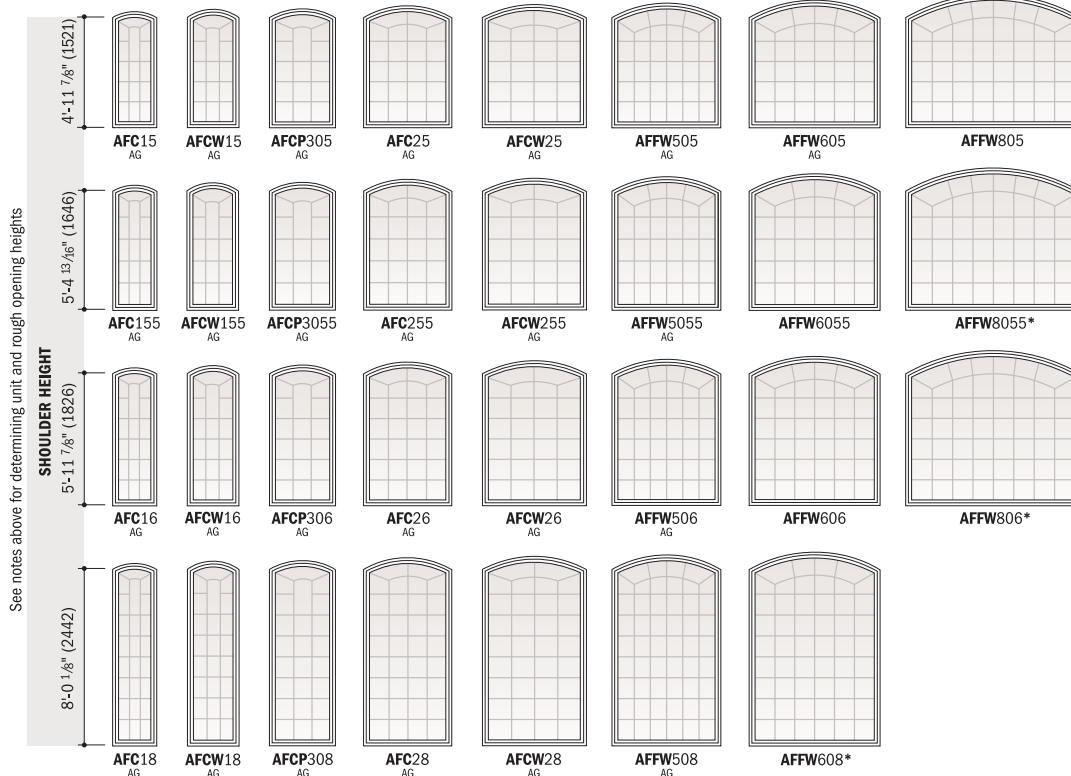
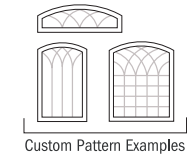
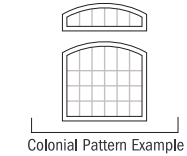

### Arch Window Unit Sizes

Unit viewed from exterior.

# 400 Series Arch Windows (1989 to Present)

Standard Windows

## Unit Sizes

### Unit Size Chart - Circle Top and Arch Top Windows

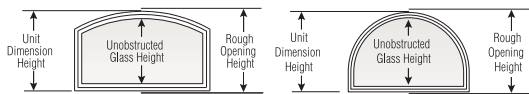

Determining Window Height Dimensions

Unit Height: add the shoulder height to the cord height (see below for these dimensions).

Rough Opening Height: add 1/2" (13mm) to the unit height.

Unobstructed Glass Height: For AC/SC units, subtract 4-7/8" (124mm) from the unit height. For APD units, subtract 5-3/16" (127mm) from the unit height.

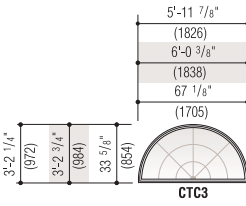
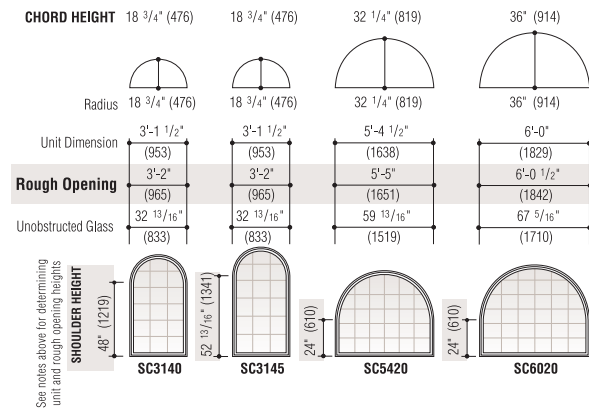
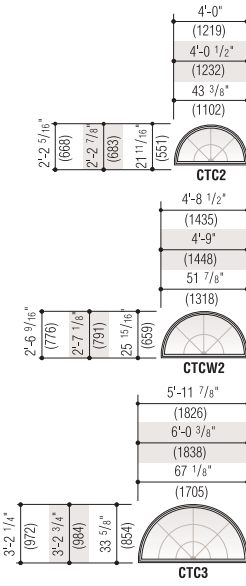
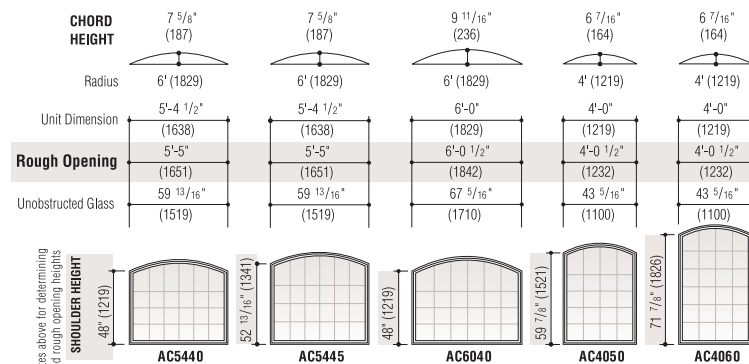
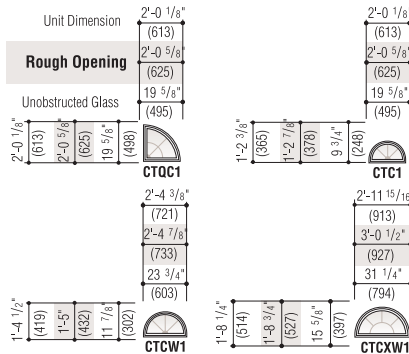
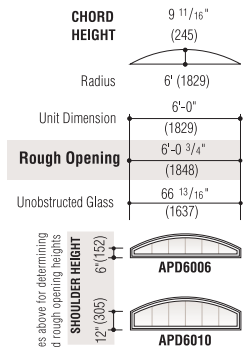

### Circle Top and Arch Top Unit Sizes

## Product History

---

### Milestones

- |             |  |
|-------------|--|
| <b>2003</b> | Stormwatch™ Protection (Coastal Product) with design pressure upgrades, glass options, and structural enhancements introduced for Arch Window units. |
| <b>1989</b> | Arch Windows introduced.   |



# 400 Series Arch Windows (1989 to Present)

Standard Windows

## Glass

### Glass Size Table

**Note:**

See drawing 04196 for more detail.

Glass Size Table		
Unit No.	Unobstructed Glass (w x h)	Actual Glass (w x h)
AFC106	$19 \frac{3}{8} \times 4 \frac{1}{2}$	$20 \frac{13}{16} \times 5 \frac{15}{16}$
AFC11	$19 \frac{3}{8} \times 10 \frac{1}{2}$	$20 \frac{13}{16} \times 11 \frac{15}{16}$
AFC12	$19 \frac{3}{8} \times 22 \frac{5}{8}$	$20 \frac{13}{16} \times 24 \frac{1}{16}$
AFC13	$19 \frac{3}{8} \times 34 \frac{7}{16}$	$20 \frac{13}{16} \times 35 \frac{7}{8}$
AFC135	$19 \frac{3}{8} \times 39 \frac{5}{16}$	$20 \frac{13}{16} \times 40 \frac{3}{4}$
AFC14	$19 \frac{3}{8} \times 46 \frac{1}{2}$	$20 \frac{13}{16} \times 47 \frac{15}{16}$
AFC145	$19 \frac{3}{8} \times 51 \frac{5}{16}$	$20 \frac{13}{16} \times 52 \frac{3}{4}$
AFC15	$19 \frac{3}{8} \times 58 \frac{3}{8}$	$20 \frac{13}{16} \times 59 \frac{13}{16}$
AFC155	$19 \frac{3}{8} \times 63 \frac{5}{16}$	$20 \frac{13}{16} \times 64 \frac{3}{4}$
AFC16	$19 \frac{3}{8} \times 70 \frac{3}{8}$	$20 \frac{13}{16} \times 71 \frac{13}{16}$
AFC18	$19 \frac{3}{8} \times 94 \frac{5}{8}$	$20 \frac{13}{16} \times 96 \frac{1}{16}$
AFCW106	$23 \frac{5}{8} \times 5 \frac{29}{32}$	$25 \frac{1}{16} \times 7 \frac{21}{64}$
AFCW11	$23 \frac{5}{8} \times 11 \frac{29}{32}$	$25 \frac{1}{16} \times 13 \frac{21}{64}$
AFCW12	$23 \frac{5}{8} \times 24 \frac{1}{32}$	$25 \frac{1}{16} \times 25 \frac{29}{64}$
AFCW13	$23 \frac{5}{8} \times 35 \frac{27}{32}$	$25 \frac{1}{16} \times 37 \frac{17}{64}$
AFCW135	$23 \frac{5}{8} \times 40 \frac{23}{32}$	$25 \frac{1}{16} \times 42 \frac{9}{64}$
AFCW14	$23 \frac{5}{8} \times 47 \frac{29}{32}$	$25 \frac{1}{16} \times 49 \frac{21}{64}$
AFCW145	$23 \frac{5}{8} \times 52 \frac{23}{32}$	$25 \frac{1}{16} \times 54 \frac{9}{64}$
AFCW15	$23 \frac{5}{8} \times 59 \frac{25}{32}$	$25 \frac{1}{16} \times 61 \frac{13}{64}$
AFCW155	$23 \frac{5}{8} \times 64 \frac{23}{32}$	$25 \frac{1}{16} \times 66 \frac{9}{64}$
AFCW16	$23 \frac{5}{8} \times 71 \frac{25}{32}$	$25 \frac{1}{16} \times 73 \frac{13}{64}$
AFCW18	$23 \frac{5}{8} \times 96 \frac{1}{32}$	$25 \frac{1}{16} \times 97 \frac{29}{64}$
AFCP3006	$31 \frac{3}{16} \times 6 \frac{1}{16}$	$32 \frac{5}{8} \times 7 \frac{31}{64}$
AFCP301	$31 \frac{3}{16} \times 12 \frac{1}{16}$	$32 \frac{5}{8} \times 13 \frac{31}{64}$
AFCP302	$31 \frac{3}{16} \times 24 \frac{3}{8}$	$32 \frac{5}{8} \times 25 \frac{39}{64}$
AFCP303	$31 \frac{3}{16} \times 36$	$32 \frac{5}{8} \times 37 \frac{27}{64}$
AFCP3035	$31 \frac{3}{16} \times 40 \frac{7}{8}$	$32 \frac{5}{8} \times 42 \frac{19}{64}$
AFCP304	$31 \frac{3}{16} \times 48 \frac{1}{16}$	$32 \frac{5}{8} \times 49 \frac{31}{64}$
AFCP3045	$31 \frac{3}{16} \times 52 \frac{7}{8}$	$32 \frac{5}{8} \times 54 \frac{19}{64}$
AFCP305	$31 \frac{3}{16} \times 59 \frac{15}{16}$	$32 \frac{5}{8} \times 61 \frac{23}{64}$
AFCP3055	$31 \frac{3}{16} \times 64 \frac{7}{8}$	$32 \frac{5}{8} \times 66 \frac{19}{64}$
AFCP306	$31 \frac{3}{16} \times 71 \frac{15}{16}$	$32 \frac{5}{8} \times 73 \frac{23}{64}$
AFCP308	$31 \frac{3}{16} \times 96 \frac{3}{16}$	$32 \frac{5}{8} \times 97 \frac{39}{64}$

## Glass

Glass Size Table		
Unit No.	Unobstructed Glass (w x h)	Actual Glass (w x h)
AFC206	43 1/4 × 7 11/16	44 11/16 × 9 7/64
AFC21	43 1/4 × 13 11/16	44 11/16 × 15 7/64
AFC22	43 1/4 × 24 13/16	44 11/16 × 27 15/64
AFC23	43 1/4 × 37 5/8	44 11/16 × 39 3/64
AFC235	43 1/4 × 42 1/2	44 11/16 × 43 15/16
AFC24	43 1/4 × 49 11/16	44 11/16 × 51 7/64
AFC245	43 1/4 × 54 1/2	44 11/16 × 55 61/64
AFC25	43 1/4 × 61 9/16	44 11/16 × 62 63/64
AFC255	43 1/4 × 66 1/2	44 11/16 × 67 15/16
AFC26	43 1/4 × 73 33/64	44 11/16 × 74 63/64
AFC28	43 1/4 × 97 13/16	44 11/16 × 99 15/64
AFCW206	51 3/4 × 8 5/16	53 3/16 × 9 3/4
AFCW21	51 3/4 × 14 5/16	53 3/16 × 15 3/4
AFCW22	51 3/4 × 26 7/16	53 3/16 × 27 7/8
AFCW23	51 3/4 × 38 1/4	53 3/16 × 39 11/64
AFCW235	51 3/4 × 43 1/8	53 3/16 × 44 1/2
AFCW24	51 3/4 × 50 5/16	53 3/16 × 51 3/4
AFCW245	51 3/4 × 55 1/8	53 3/16 × 56 1/2
AFCW25	51 3/4 × 62 3/16	53 3/16 × 63 5/8
AFCW255	51 3/4 × 67 1/8	53 3/16 × 68 1/2
AFCW26	51 3/4 × 74 3/16	53 3/16 × 75 5/8
AFCW28	51 3/4 × 98 7/16	53 3/16 × 99 7/8
AFFW5006	54 1/2 × 9 1/16	55 15/16 × 10 37/64
AFFW501	54 1/2 × 15 1/16	55 15/16 × 16 37/64
AFFW502	54 1/2 × 27 3/16	55 15/16 × 28 45/64
AFFW503	54 1/2 × 39	55 15/16 × 40 33/64
AFFW5035	54 1/2 × 43 7/8	55 15/16 × 45 25/64
AFFW504	54 1/2 × 51 1/16	55 15/16 × 52 37/64
AFFW5045	54 1/2 × 55 7/8	55 15/16 × 57 25/64
AFFW505	54 1/2 × 62 15/16	55 15/16 × 64 29/64
AFFW5055	54 1/2 × 67 7/8	55 15/16 × 69 25/64
AFFW506	54 1/2 × 74 15/16	55 15/16 × 76 29/64
AFFW508	54 1/2 × 99 3/16	55 15/16 × 100 39/64
AFFW6006	66 1/2 × 10 11/16	67 15/16 × 12 7/64
AFFW601	66 1/2 × 16 11/16	67 15/16 × 18 7/64
AFFW602	66 1/2 × 28 13/16	67 15/16 × 30 1/4
AFFW603	66 1/2 × 40 5/8	67 15/16 × 42 3/64

## 400 Series Arch Windows (1989 to Present)

*Standard Windows*

### Glass

Glass Size Table		
Unit No.	Unobstructed Glass (w x h)	Actual Glass (w x h)
AFFW6035	$66 \frac{1}{2} \times 45 \frac{1}{2}$	$67 \frac{15}{16} \times 46 \frac{15}{16}$
AFFW604	$66 \frac{1}{2} \times 52 \frac{11}{16}$	$67 \frac{15}{16} \times 54 \frac{7}{64}$
AFFW6045	$66 \frac{1}{2} \times 57 \frac{1}{2}$	$67 \frac{15}{16} \times 58 \frac{15}{16}$
AFFW605	$66 \frac{1}{2} \times 64 \frac{9}{16}$	$67 \frac{15}{16} \times 65 \frac{63}{64}$
AFFW6055	$66 \frac{1}{2} \times 69 \frac{1}{2}$	$67 \frac{15}{16} \times 70 \frac{15}{16}$
AFFW606	$66 \frac{1}{2} \times 76 \frac{9}{16}$	$67 \frac{15}{16} \times 77 \frac{63}{64}$
AFFW608	$66 \frac{1}{2} \times 100 \frac{13}{16}$	$67 \frac{15}{16} \times 102 \frac{15}{64}$
AFFW8006	$90 \frac{3}{8} \times 13 \frac{7}{8}$	$91 \frac{13}{16} \times 15 \frac{19}{64}$
AFFW801	$90 \frac{3}{8} \times 19 \frac{7}{8}$	$91 \frac{13}{16} \times 21 \frac{19}{64}$
AFFW802	$90 \frac{3}{8} \times 32$	$91 \frac{13}{16} \times 33 \frac{27}{64}$
AFFW803	$90 \frac{3}{8} \times 43 \frac{13}{16}$	$91 \frac{13}{16} \times 45 \frac{15}{64}$
AFFW8035	$90 \frac{3}{8} \times 48 \frac{11}{16}$	$91 \frac{13}{16} \times 50 \frac{7}{64}$
AFFW804	$90 \frac{3}{8} \times 55 \frac{7}{8}$	$91 \frac{13}{16} \times 57 \frac{19}{64}$
AFFW8045	$90 \frac{3}{8} \times 60 \frac{11}{16}$	$91 \frac{13}{16} \times 62 \frac{7}{64}$
AFFW805	$90 \frac{3}{8} \times 67 \frac{3}{4}$	$91 \frac{13}{16} \times 69 \frac{11}{64}$
AFFW8055	$90 \frac{3}{8} \times 72 \frac{11}{16}$	$91 \frac{13}{16} \times 74 \frac{7}{64}$
AFFW806	$90 \frac{3}{8} \times 79 \frac{3}{4}$	$91 \frac{13}{16} \times 81 \frac{11}{64}$
AFFW12006	$136 \frac{1}{4} \times 15 \frac{1}{16}$	$137 \frac{11}{16} \times 16 \frac{31}{64}$
AFFW1201	$136 \frac{1}{4} \times 21 \frac{1}{16}$	$137 \frac{11}{16} \times 27 \frac{31}{64}$
AFFW1202	$136 \frac{1}{4} \times 33 \frac{1}{16}$	$137 \frac{11}{16} \times 34 \frac{41}{64}$

## Glass

### Glass

**Note:**

Order glass stops separately.

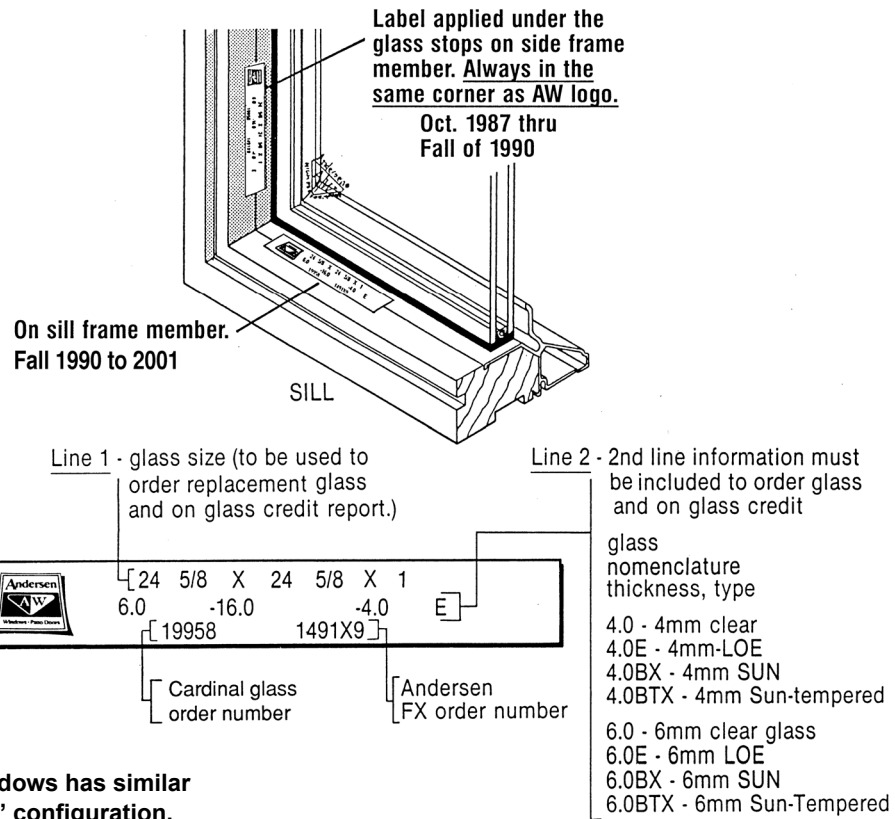

**Arch Glass Dimension Label**

### Glass - High-Performance

**Note:**

Available by description. Use the glass label on the unit (see illustration above) to order.

### Glass - High-Performance Finelight

**Note:**

Available by description. Use the glass label on the unit (see illustration above) to order.

### Glass - High-Performance Sun 3

**Note:**

Available by description. Use the glass label on the unit (see illustration above) to order.

# 400 Series Arch Windows (1989 to Present)

Standard Windows

## Glass

### Glass - High-Performance Sun II

**Note:**

Available by description. Use the glass label on the unit (see illustration on [page 12](#)) to order.

### Glass - High-Performance Tempered

**Note:**

Available by description. Use the glass label on the unit (see illustration on [page 12](#)) to order.

### Glass - High-Performance Sun 3 Tempered

**Note:**

Available by description. Use the glass label on the unit (see illustration on [page 12](#)) to order.

### Glass - High-Performance Sun II Tempered

**Note:**

Available by description. Use the glass label on the unit (see illustration on [page 12](#)) to order.

## Glass Parts

### Setting Block

**Note:**

Available by description as glass widths can vary.  
Use the glass label on the unit (see illustration on [page 4](#)) to order.  
Standard size setting blocks are shown below.

	Dimensions	Order No.
	1 x 1/4 x 6	2250002
Setting Block - Head and Side		
	Dimensions	Order No.
	7/8 x 1/8 x 6	2250109
Setting Block - Spacer		
	Dimensions	Order No.
	1 x 1/4 x 6	2250106
Lateral Spacer - Arch and Quarter Round		
Note:		Order No.
Order by the foot. Install between glass and aluminum outer frame.		2230012

# Grilles

## Interior Grilles - Colonial

**Note:**

Grilles include fasteners. See [Accessory Guide 005285](#). See [Accessory Guide 005085](#).

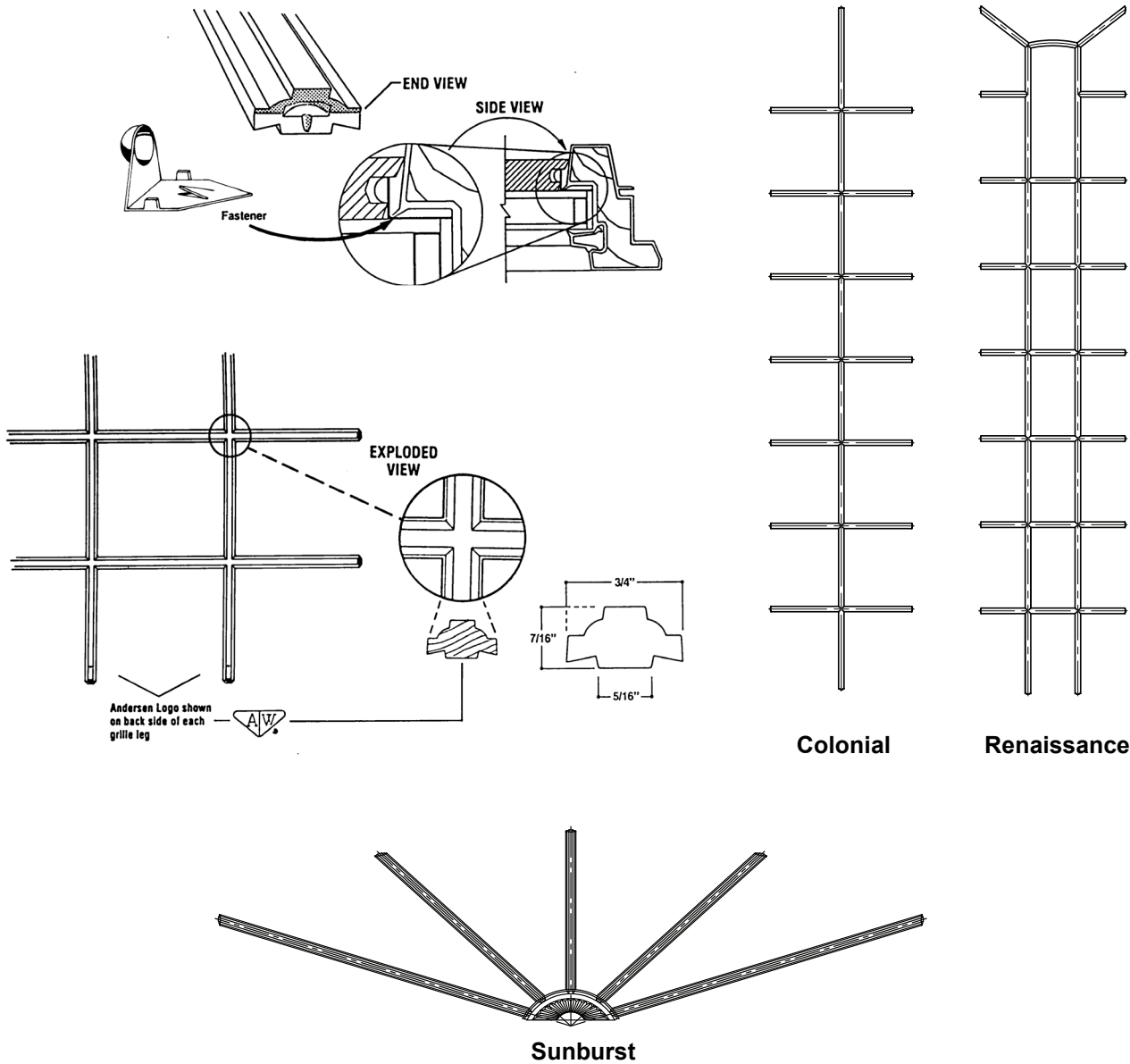

Arch Window Wide Profile Interior Grilles

# 400 Series Arch Windows (1989 to Present)

Standard Windows

## Grilles

Interior Grille - Colonial / 3/4" Wood / Natural Wood Interior (1-Piece)								
Unit No.	Dimensions (w x h)	Exterior						
		White	Terratone	Sandtone	Forest Green	Canvas	Dark Bronze	Black
		Maple Interior						
<b>AFC12</b>	19 15/32 × 22 23/32	2263406	2264006	2264606	2267237	9053184	9072598	9127777
<b>AFC13</b>	19 15/32 × 34 17/32	2263408	2264008	2264608	2267238	9053185	9072599	9127778
<b>AFC135</b>	19 15/32 × 39 13/32	2263410	2264010	2264610	2267239	9053186	9072600	9127779
<b>AFC14</b>	19 15/32 × 46 19/32	2263412	2264012	2264612	2267240	9053187	9072601	9127780
<b>AFC145</b>	19 15/32 × 51 13/32	2263414	2264014	2264614	2267241	9053188	9072602	9127781
<b>AFC15</b>	19 15/32 × 58 15/32	2263416	2264016	2264616	2267242	9053189	9072603	9127782
<b>AFC155</b>	19 15/32 × 63 13/32	2263418	2264018	2264618	2267243	9053190	9072604	9127783
<b>AFC16</b>	19 15/32 × 70 15/32	2263420	2264020	2264620	2267244	9053191	9072605	9127784
<b>AFC18</b>	19 15/32 × 94 23/32	2263422	2264022	2264622	2267245	9053192	9072606	9127785
<b>AFCW12</b>	23 23/32 × 24 3/32	2263428	2264028	2264628	2267248	9053195	9072609	9127788
<b>AFCW13</b>	23 23/32 × 35 29/32	2263430	2264030	2264630	2267249	9053196	9072610	9127789
<b>AFCW135</b>	23 23/32 × 40 25/32	2263432	2264032	2264632	2267250	9053197	9072611	9127790
<b>AFCW14</b>	23 23/32 × 47 31/32	2263434	2264034	2264634	2267251	9053198	9072612	9127791
<b>AFCW145</b>	23 23/32 × 52 25/32	2263436	2264036	2264636	2267252	9053199	9072613	9127792
<b>AFCW15</b>	23 23/32 × 59 27/32	2263438	2264038	2264638	2267253	9053200	9072614	9127793
<b>AFCW155</b>	23 23/32 × 64 25/32	2263440	2264040	2264640	2267254	9053201	9072615	9127794
<b>AFCW16</b>	23 23/32 × 71 27/32	2263442	2264042	2264642	2267255	9053202	9072616	9127795
<b>AFCW18</b>	23 23/32 × 96 3/32	2263444	2264044	2264644	2267256	9053203	9072617	9127796
<b>AFCP302</b>	31 9/32 × 23 13/16	2263450	2264050	2264650	2267259	9053206	9072620	9127799
<b>AFCP303</b>	31 9/32 × 35 11/16	2263452	2264052	2264652	2267260	9053207	9072621	9127800
<b>AFCP3035</b>	31 9/32 × 40 9/16	2263454	2264054	2264654	2267261	9053208	9072622	9127801
<b>AFCP304</b>	31 9/32 × 47 3/4	2263456	2264056	2264656	2267262	9053209	9072623	9127802
<b>AFCP3045</b>	31 9/32 × 52 9/16	2263458	2264058	2264658	2267263	9053210	9072624	9127803
<b>AFCP305</b>	31 9/32 × 58 5/8	2263460	2264060	2264660	2267264	9053211	9072625	9127804
<b>AFCP3055</b>	31 9/32 × 64 9/16	2263462	2264062	2264662	2267265	9053212	9072626	9127805
<b>AFCP306</b>	31 9/32 × 71 5/8	2263464	2264064	2264664	2267266	9053213	9072627	9127806
<b>AFCP308</b>	31 9/32 × 95 7/8	2263466	2264066	2264666	2267267	9053214	9072628	9127807
<b>AFC22</b>	43 11/32 × 25 29/32	2263506	2264106	2264706	2267270	9053217	9072631	9127810
<b>AFC23</b>	43 11/32 × 37 23/32	2263508	2264108	2264708	2267271	9053218	9072632	9127811
<b>AFC235</b>	43 11/32 × 42 19/32	2263510	2264110	2264710	2267272	9053219	9072633	9127812
<b>AFC24</b>	43 11/32 × 49 25/32	2263512	2264112	2264712	2267273	9053220	9072634	9127813

### Grilles

Interior Grille - Colonial / 3/4" Wood / Natural Wood Interior (1-Piece)								
Unit No.	Dimensions (w x h)	Exterior						
		White	Terratone	Sandtone	Forest Green	Canvas	Dark Bronze	Black
		Maple Interior						
<b>AFC245</b>	43 11/32 x 54 19/32	2263514	2264114	2264714	2267274	9053221	9072635	9127814
<b>AFC25</b>	43 11/32 x 61 21/32	2263516	2264116	2264716	2267275	9053222	9072636	9127815
<b>AFC255</b>	43 11/32 x 66 19/32	2263518	2264118	2264718	2267276	9053223	9072637	9127816
<b>AFC26</b>	43 11/32 x 73 21/32	2263520	2264120	2264720	2267277	9053224	9072638	9127817
<b>AFC28</b>	43 11/32 x 97 29/32	2263522	2264122	2264722	2267278	9053225	9072639	9127818
<b>AFCW21</b>	12 7/8 x 14 13/32 x 12 7/8	2263526	2264126	2264726	2267280	9053227	9072641	9127906
<b>AFCW22</b>	51 27/32 x 26 17/32	2263528	2264128	2264728	2267281	9053228	9072642	9127821
<b>AFCW23</b>	51 27/32 x 38 11/32	2263530	2264130	2264730	2267282	9053229	9072643	9127822
<b>AFCW235</b>	51 27/32 x 43 7/32	2263532	2264132	2264732	2267283	9053230	9072644	9127823
<b>AFCW24</b>	51 27/32 x 50 13/32	2263534	2264134	2264734	2267284	9053231	9072645	9127824
<b>AFCW245</b>	51 27/32 x 55 7/32	2263536	2264136	2264736	2267285	9053232	9072646	9127825
<b>AFCW25</b>	51 27/32 x 62 9/32	2263538	2264138	2264738	2267286	9053233	9072647	9127826
<b>AFCW255</b>	51 27/32 x 67 7/32	2263540	2264140	2264740	2267287	9053234	9072648	9127827
<b>AFCW26</b>	51 27/32 x 74 7/32	2263542	2264142	2264742	2267288	9053235	9072649	9127828
<b>AFCW28</b>	51 27/32 x 98 17/32	2263544	2264144	2264744	2267289	9053226	9072650	9127829

Interior Grille - Colonial / 7/8 Wood / Natural Wood Interior (1-Piece)								
Unit No.	Dimensions (w x h)	Exterior						
		White	Terratone	Sandtone	Forest Green	Canvas	Dark Bronze	Black
		Maple Interior						
<b>AFFW502</b>	54 19/32 x 27 9/32	2263606	2264206	2264806	2267292	9053239	9072653	9127832
<b>AFFW503</b>	54 19/32 x 39 3/32	2263608	2264208	2264808	2267293	9053240	9072654	9127833
<b>AFFW5035</b>	54 19/32 x 43 31/32	2263610	2264210	2264810	2267294	9053241	9072655	9127834
<b>AFFW504</b>	54 19/32 x 51 5/32	2263612	2264212	2264812	2267295	9053242	9072656	9127835
<b>AFFW5045</b>	54 19/32 x 55 31/32	2263614	2264214	2264814	2267296	9053243	9072657	9127836
<b>AFFW505</b>	54 19/32 x 63 1/32	2263616	2264216	2264816	2267297	9053244	9072658	9127837
<b>AFFW5055</b>	54 19/32 x 67 31/32	2263618	2264218	2264818	2267298	9053245	9072659	9127838
<b>AFFW506</b>	54 19/32 x 75 1/32	2263620	2264220	2264820	2267299	9053246	9072660	9127839
<b>AFFW508</b>	54 19/32 x 99 9/32	2263622	2264222	2264822	2267301	9053247	9072661	9127840
<b>AFFW602</b>	66 19/32 x 28 29/32	2263628	2264228	2264828	2267304	9053250	9072664	9127843



# 400 Series Arch Windows (1989 to Present)

Standard Windows

## Grilles

Interior Grille - Colonial / 7/8 Wood / Natural Wood Interior (1-Piece)								
Unit No.	Dimensions (w x h)	Exterior						
		White	Terratone	Sandtone	Forest Green	Canvas	Dark Bronze	Black
		Maple Interior						
<b>AFFW603</b>	66 <sup>19</sup> / <sub>32</sub> × 40 <sup>23</sup> / <sub>32</sub>	2263630	2264230	2264830	2267305	9053251	9072665	9127844
<b>AFFW6035</b>	66 <sup>19</sup> / <sub>32</sub> × 45 <sup>19</sup> / <sub>32</sub>	2263632	2264232	2264832	2267306	9053252	9072666	9127845
<b>AFFW604</b>	66 <sup>19</sup> / <sub>32</sub> × 52 <sup>25</sup> / <sub>32</sub>	2263634	2264234	2264834	2267307	9053253	9072667	9127846
<b>AFFW6045</b>	66 <sup>19</sup> / <sub>32</sub> × 57 <sup>19</sup> / <sub>32</sub>	2263636	2264236	2264836	2267308	9053254	9072668	9127847
<b>AFFW605</b>	66 <sup>19</sup> / <sub>32</sub> × 64 <sup>21</sup> / <sub>32</sub>	2263638	2264238	2264838	2267309	9053255	9072669	9127848
<b>AFFW6055</b>	66 <sup>19</sup> / <sub>32</sub> × 69 <sup>19</sup> / <sub>32</sub>	2263640	2264240	2264840	2267310	9053256	9072670	9127849
<b>AFFW606</b>	66 <sup>19</sup> / <sub>32</sub> × 76 <sup>21</sup> / <sub>32</sub>	2263642	2264242	2264842	2267311	9053257	9072671	9127850
<b>AFFW608</b>	66 <sup>19</sup> / <sub>32</sub> × 100 <sup>29</sup> / <sub>32</sub>	2263644	2264244	2264844	2267312	9053258	9072672	9127851
<b>AFFW802</b>	90 <sup>15</sup> / <sub>32</sub> × 32 <sup>3</sup> / <sub>32</sub>	2263650	2264250	2264850	2267315	9053261	9072675	9127854
<b>AFFW803</b>	90 <sup>15</sup> / <sub>32</sub> × 43 <sup>29</sup> / <sub>32</sub>	2263652	2264252	2264852	2267316	9053262	9072676	9127855
<b>AFFW8035</b>	90 <sup>15</sup> / <sub>32</sub> × 48 <sup>25</sup> / <sub>32</sub>	2263654	2264254	2264854	2267317	9053263	9072677	9127856
<b>AFFW804</b>	90 <sup>15</sup> / <sub>32</sub> × 55 <sup>31</sup> / <sub>32</sub>	2263656	2264256	2264856	2267318	9053264	9072678	9127857
<b>AFFW8045</b>	90 <sup>15</sup> / <sub>32</sub> × 60 <sup>25</sup> / <sub>32</sub>	2263658	2264258	2264858	2267319	9053265	9062679	9127858
<b>AFFW805</b>	90 <sup>15</sup> / <sub>32</sub> × 67 <sup>27</sup> / <sub>32</sub>	2263660	2264260	2264860	2267320	9053266	9072680	9127859
<b>AFFW8055</b>	90 <sup>15</sup> / <sub>32</sub> × 72 <sup>25</sup> / <sub>32</sub>	2263662	2264262	2264862	2267321	9053267	9072681	9127860
<b>AFFW806</b>	90 <sup>15</sup> / <sub>32</sub> × 79 <sup>27</sup> / <sub>32</sub>	2263664	2264264	2264864	2267322	9053268	9072682	9127861

Interior Grille - Colonial / 3/4" Wood / Natural Wood Interior (Vertical Pieces Only)								
Unit No.	Dimensions (h)	Exterior						
		White	Terratone	Sandtone	Forest Green	Canvas	Dark Bronze	Black
		Maple Interior						
<b>AFC106</b>	4 <sup>14</sup> / <sub>32</sub>	2263402	2264002	2264602	2267235	9053182	9072596	9127775
<b>AFC11</b>	10 <sup>19</sup> / <sub>32</sub>	2263404	2264004	2264604	2267236	9053183	9072597	9127776
<b>AFCW106</b>	5 <sup>31</sup> / <sub>32</sub>	2263424	2264024	2264624	2267246	9053193	9072607	9127786
<b>AFCW11</b>	11 <sup>31</sup> / <sub>32</sub>	2263426	2264026	2264626	2267247	9053194	9072608	9127787
<b>AFCP3006</b>	R5 <sup>47</sup> / <sub>64</sub> • L54 <sup>7</sup> / <sub>64</sub>	2263446	2264046	2264646	2267257	9053204	9072618	9127797
<b>AFCP301</b>	R&L 11 <sup>47</sup> / <sub>64</sub>	2263448	2264048	2264648	2267258	9053205	9072619	9127798
<b>AFC206</b>	6 <sup>29</sup> / <sub>64</sub> • 7 <sup>5</sup> / <sub>32</sub> • 6 <sup>29</sup> / <sub>64</sub>	2263502	2264102	2264702	2267268	9053215	9072629	9127808
<b>AFC21</b>	12 <sup>29</sup> / <sub>64</sub> • 14 <sup>13</sup> / <sub>32</sub> • 12 <sup>29</sup> / <sub>64</sub>	2263504	2264104	2264704	2267269	9053216	9072630	9127809
<b>AFCW206</b>	6 <sup>57</sup> / <sub>64</sub> • 8 <sup>13</sup> / <sub>32</sub> • 6 <sup>57</sup> / <sub>64</sub>	2263524	2264124	2264724	2267279	9053226	9072640	9127819
<b>AFCW21</b>	12 <sup>57</sup> / <sub>64</sub> • 13 <sup>25</sup> / <sub>32</sub> • 12 <sup>57</sup> / <sub>64</sub>	2263526	2264126	2264726	2267280	9053227	9072641	9127820

## Grilles

Interior Grille - Colonial / 3/4" Wood / Prefinished Interior (1-Piece)								
Unit No.	Dimensions (w x h)	Exterior						
		White	Terratone	Sandtone	Forest Green	Canvas	Dark Bronze	Black
		Interior						
		White	Terratone	Sandtone	Forest Green	Canvas	Dark Bronze	Black
AFC12	19 15/32 x 22 23/32	2263706	2264306	2264906	By description	9053271	9072685	9127864
AFC13	19 15/32 x 34 17/32	2263708	2264308	2264908	By description	9053272	9072686	9127865
AFC135	19 15/32 x 39 13/32	2263710	2264310	2264910	By description	9053273	9072687	9127866
AFC14	19 15/32 x 46 19/32	2263712	2264312	2264912	By description	9053274	9072688	9127867
AFC145	19 15/32 x 51 13/32	2263714	2264314	2264914	By description	9053275	9072689	9127868
AFC15	19 15/32 x 58 15/32	2263716	2264316	2264916	By description	9053276	9072690	9127869
AFC155	19 15/32 x 63 13/32	2263718	2264318	2264918	By description	9053277	9072691	9127870
AFC16	19 15/32 x 70 15/32	2263720	2264320	2264920	By description	9053278	9072692	9127871
AFC18	19 15/32 x 94 23/32	2263722	2264322	2264922	By description	9053279	9072693	9127872
AFCW12	23 23/32 x 24 3/32	2263728	2264328	2264928	By description	9053282	9072696	9127875
AFCW13	23 23/32 x 35 29/32	2263730	2264330	2264930	By description	9053283	9072697	9127876
AFCW135	23 23/32 x 40 25/32	2263732	2264332	2264932	By description	9053284	9072698	9127877
AFCW14	23 23/32 x 47 31/32	2263734	2264334	2264934	By description	9053285	9072699	9127878
AFCW145	23 23/32 x 52 25/32	2263736	2264336	2264936	By description	9053286	9072700	9127879
AFCW15	23 23/32 x 59 27/32	2263738	2264338	2264938	By description	9053287	9072701	9127880
AFCW155	23 23/32 x 64 25/32	2263740	2264340	2264940	By description	9053288	9072702	9127881
AFCW16	23 23/32 x 71 27/32	2263742	2264342	2264942	By description	9053289	9072703	9127882
AFCW18	23 23/32 x 96 3/32	2263744	2264344	2264944	By description	9053290	9072704	9127883
AFCP302	31 9/32 x 23 13/16	2263750	2264350	2264950	By description	9053293	9072707	9127886
AFCP303	31 9/32 x 35 11/16	2263752	2264352	2264952	By description	9053294	9072708	9127887
AFCP3035	31 9/32 x 40 9/16	2263754	2264354	2264954	By description	9053295	9072709	9127888
AFCP304	31 9/32 x 47 3/4	2263756	2264356	2264956	By description	9053296	9072710	9127889
AFCP3045	31 9/32 x 52 9/16	2263758	2264358	2264958	By description	9053297	9072711	9127890
AFCP305	31 9/32 x 58 5/8	2263760	2264360	2264960	By description	9053298	9072712	9127891
AFCP3055	31 9/32 x 64 9/16	2263762	2264362	2264962	By description	9053299	9072713	9127892
AFCP306	31 9/32 x 71 5/8	2263764	2264364	2264964	By description	9053300	9072714	9127893
AFCP308	31 9/32 x 95 7/8	2263766	2264366	2264966	By description	9053301	9072715	9127894
AFC22	43 11/32 x 25 29/32	2263806	2264406	2265006	By description	9053304	9072718	9127897
AFC23	43 11/32 x 37 23/32	2263808	2264408	2265008	By description	9053305	9072719	9127898
AFC235	43 11/32 x 42 19/32	2263810	2264410	2265010	By description	9053306	9072720	9127899
AFC24	43 11/32 x 49 25/32	2263812	2264412	2265012	By description	9053307	9072721	9127900
AFC245	43 11/32 x 54 19/32	2263814	2264414	2265014	By description	9053308	9072722	9127901

# 400 Series Arch Windows (1989 to Present)

Standard Windows

## Grilles

Interior Grille - Colonial / 3/4" Wood / Prefinished Interior (1-Piece)								
Unit No.	Dimensions (w x h)	Exterior						
		White	Terratone	Sandtone	Forest Green	Canvas	Dark Bronze	Black
		Interior						
		White	Terratone	Sandtone	Forest Green	Canvas	Dark Bronze	Black
<b>AFC25</b>	43 <sup>11</sup> / <sub>32</sub> × 61 <sup>21</sup> / <sub>32</sub>	2263816	2264416	2265016	By description	9053309	9072723	9127902
<b>AFC255</b>	43 <sup>11</sup> / <sub>32</sub> × 66 <sup>19</sup> / <sub>32</sub>	2263818	2264418	2265018	By description	9053310	9072724	9127903
<b>AFC26</b>	43 <sup>11</sup> / <sub>32</sub> × 73 <sup>21</sup> / <sub>32</sub>	2263820	2264420	2265020	By description	9053311	9072725	9127904
<b>AFC28</b>	43 <sup>11</sup> / <sub>32</sub> × 97 <sup>29</sup> / <sub>32</sub>	2263822	2264422	2265022	By description	By description	By description	By description
<b>AFCW22</b>	51 <sup>27</sup> / <sub>32</sub> × 26 <sup>17</sup> / <sub>32</sub>	2263828	2264428	2265028	By description	9053314	9072728	9127907
<b>AFCW23</b>	51 <sup>27</sup> / <sub>32</sub> × 38 <sup>11</sup> / <sub>32</sub>	2263830	2264430	2265030	By description	9053315	9072729	9127908
<b>AFCW235</b>	51 <sup>27</sup> / <sub>32</sub> × 43 <sup>7</sup> / <sub>32</sub>	2263832	2264432	2265032	By description	9053316	9072730	9127909
<b>AFCW24</b>	51 <sup>27</sup> / <sub>32</sub> × 50 <sup>13</sup> / <sub>32</sub>	2263834	2264434	2265034	By description	9053317	9072731	9127910
<b>AFCW245</b>	51 <sup>27</sup> / <sub>32</sub> × 55 <sup>7</sup> / <sub>32</sub>	2263836	2264436	2265036	By description	9053318	9072732	9127911
<b>AFCW25</b>	51 <sup>27</sup> / <sub>32</sub> × 62 <sup>9</sup> / <sub>32</sub>	2263838	2264438	2265038	By description	9053319	9072733	9127912
<b>AFCW255</b>	51 <sup>27</sup> / <sub>32</sub> × 67 <sup>7</sup> / <sub>32</sub>	2263840	2264440	2265040	By description	9053320	9072734	9127913
<b>AFCW26</b>	51 <sup>27</sup> / <sub>32</sub> × 74 <sup>7</sup> / <sub>32</sub>	2263842	2264442	2265042	By description	9053321	9072735	9127914
<b>AFCW28</b>	51 <sup>27</sup> / <sub>32</sub> × 98 <sup>17</sup> / <sub>32</sub>	2263844	2264444	2265044	By description	9053322	9072736	9127915

## Grilles

Interior Grille - Colonial / 7/8" Wood / Prefinished Interior (1-Piece)								
Unit No.	Dimensions (w x h)	Exterior						
		White	Terratone	Sandtone	Forest Green	Canvas	Dark Bronze	Black
		Interior						
		White	Terratone	Sandtone	Forest Green	Canvas	Dark Bronze	Black
AFFW502	54 19/32 x 27 9/32	2263906	2264506	2265106	By description	9053325	9072739	9127918
AFFW503	54 19/32 x 39 3/32	2263908	2264508	2265108	By description	9053326	9072740	9127919
AFFW5035	54 19/32 x 43 31/32	2263910	2264510	2265110	By description	9053327	9072741	9127920
AFFW504	54 19/32 x 51 5/32	2263912	2264512	2265112	By description	9053328	9072742	9127921
AFFW5045	54 19/32 x 55 31/32	2263914	2264514	2265114	By description	9053329	9072743	9127922
AFFW505	54 19/32 x 63 1/32	2263916	2264516	2265116	By description	9053330	9072744	9127923
AFFW5055	54 19/32 x 67 31/32	2263918	2264518	2265118	By description	9053331	9072745	9127924
AFFW506	54 19/32 x 75 1/32	2263920	2264520	2265120	By description	9053332	9072746	9127925
AFFW508	54 19/32 x 99 9/32	2263922	2264522	2265122	By description	9053333	9072747	9127926
AFFW602	66 19/32 x 28 29/32	2263928	2264528	2265128	By description	9053336	9072750	9127929
AFFW603	66 19/32 x 40 23/32	2263930	2264530	2265130	By description	9053337	9072751	9127930
AFFW6035	66 19/32 x 45 19/32	2263932	2264532	2265132	By description	9053338	9072752	9127931
AFFW604	66 19/32 x 52 25/32	2263934	2264534	2265134	By description	9053339	9072753	9127932
AFFW6045	66 19/32 x 57 19/32	2263936	2264536	2265136	By description	9053340	9072754	9127933
AFFW605	66 19/32 x 64 21/32	2263938	2264538	2265138	By description	9053341	9072755	9127934
AFFW6055	66 19/32 x 69 19/32	2263940	2264540	2265140	By description	9053342	9072756	9127935
AFFW606	66 19/32 x 79 21/32	2263942	2264542	2265142	By description	9053343	9072757	9127936
AFFW608	66 19/32 x 100 29/32	2263944	2264544	2265144	By description	9053344	9072758	9127937
AFFW802	90 15/32 x 32 3/32	2263950	2264550	2265150	By description	9053347	9072761	9127940
AFFW803	90 15/32 x 43 29/32	2263952	2264552	2265152	By description	9053348	9072762	9127941
AFFW8035	90 15/32 x 48 25/32	2263954	2264554	2265154	By description	9053349	9072763	9127942
AFFW804	90 15/32 x 55 31/32	2263956	2264556	2265156	By description	9053350	9072764	9127943
AFFW8045	90 15/32 x 60 25/32	2263958	2264558	2265158	By description	9053351	9072765	9127944
AFFW805	90 15/32 x 67 27/32	2263960	2264560	2265160	By description	9053352	9072766	9127945
AFFW8055	90 15/32 x 72 25/32	2263962	2264562	2265162	By description	9053353	9072767	9127946
AFFW806	90 15/32 x 79 27/32	2263964	2264564	2265164	By description	9053354	9072768	9127947

# 400 Series Arch Windows (1989 to Present)

Standard Windows

## Grilles

Interior Grille - Colonial / 3/4" Wood / Prefinished Interior (Vertical Pieces Only)								
Unit No.	Dimensions (h)	Exterior						
		White	Terratone	Sandtone	Forest Green	Canvas	Dark Bronze	Black
		Interior						
		White	Terratone	Sandtone	Forest Green	Canvas	Dark Bronze	Black
<b>AFC106</b>	4 <sup>14</sup> / <sub>32</sub>	2263702	2264302	2264902	By description	9053269	9072683	9127862
<b>AFC11</b>	10 <sup>19</sup> / <sub>32</sub>	2263704	2264304	2264904	By description	9053270	9072684	9127863
<b>AFCW106</b>	5 <sup>31</sup> / <sub>32</sub>	2263724	2264324	2264924	By description	9053280	9072694	9127873
<b>AFCW11</b>	11 <sup>31</sup> / <sub>32</sub>	2263726	2264326	2264926	By description	9053281	9072695	9127874
<b>AFCP3006</b>	R5 <sup>47</sup> / <sub>64</sub> • L54 <sup>7</sup> / <sub>64</sub>	2263746	2264346	2264946	By description	9053291	9072705	9127884
<b>AFCP301</b>	R&L 11 <sup>47</sup> / <sub>64</sub>	2263748	2264348	2264948	By description	9053292	9072706	9127885
<b>AFC206</b>	6 <sup>29</sup> / <sub>64</sub> • 7 <sup>5</sup> / <sub>32</sub> • 6 <sup>29</sup> / <sub>64</sub>	2263802	2264402	2265002	By description	9053302	9072716	9127895
<b>AFC21</b>	12 <sup>29</sup> / <sub>64</sub> • 14 <sup>13</sup> / <sub>32</sub> • 12 <sup>29</sup> / <sub>64</sub>	2263804	2264404	2265004	By description	9053303	9072717	9127896
<b>AFCW206</b>	6 <sup>57</sup> / <sub>64</sub> • 8 <sup>13</sup> / <sub>32</sub> • 6 <sup>57</sup> / <sub>64</sub>	2263824	2264424	2265024	By description	9053312	9072726	9127905
<b>AFCW21</b>	12 <sup>57</sup> / <sub>64</sub> • 13 <sup>25</sup> / <sub>32</sub> • 12 <sup>57</sup> / <sub>64</sub>	2263826	2264426	2265026	By description	9053313	9072727	9127862

## Grilles

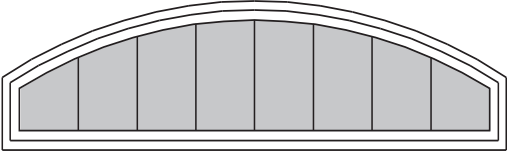
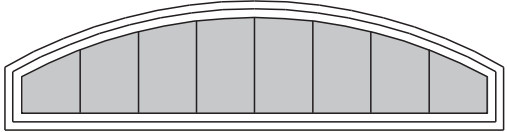
Interior Grille - Colonial / 7/8" Wood / Natural Wood Interior								
								
Unit No.	Dimensions (h)	Exterior						
		White	Terratone	Sandtone	Forest Green	Canvas	Dark Bronze	Black
		Maple Interior						
<b>AFFW5006</b>	6 <sup>9</sup> / <sub>64</sub> • 8 <sup>7</sup> / <sub>16</sub> • 9 <sup>11</sup> / <sub>64</sub>	2263602	2264202	2264802	2267290	9053237	9072651	9127830
<b>AFFW501</b>	12 <sup>9</sup> / <sub>64</sub> • 14 <sup>7</sup> / <sub>16</sub> • 15 <sup>11</sup> / <sub>64</sub>	2263604	2264204	2264804	2267291	9053238	9072652	9127831
<b>AFFW6006</b>	7 <sup>1</sup> / <sub>16</sub> • 9 <sup>7</sup> / <sub>8</sub> • 10 <sup>25</sup> / <sub>64</sub>	2263624	2264224	2264824	2267302	9053248	9072662	9127841
<b>AFFW601</b>	13 <sup>1</sup> / <sub>16</sub> • 15 <sup>7</sup> / <sub>8</sub> • 16 <sup>25</sup> / <sub>32</sub>	2263626	2264226	2264826	2267303	9053249	9072663	9127842
<b>AFFW8006</b>	7 <sup>31</sup> / <sub>64</sub> • 11 <sup>9</sup> / <sub>64</sub> • 13 <sup>1</sup> / <sub>4</sub> • 13 <sup>61</sup> / <sub>64</sub>	2263646	2264246	2264846	2267313	9053259	9072673	9127852
<b>AFFW801</b>	13 <sup>31</sup> / <sub>64</sub> • 17 <sup>9</sup> / <sub>64</sub> • 19 <sup>1</sup> / <sub>4</sub> • 19 <sup>61</sup> / <sub>64</sub>	2263648	2264248	2264848	2267314	9053260	9072674	9127853
Interior Grille - Colonial / 7/8" Wood / Natural Wood Interior (Vertical Pieces Only)								
								
Unit No.	Dimensions (h)	Exterior						
		White	Terratone	Sandtone	Forest Green	Canvas	Dark Bronze	Black
		Maple Interior						
<b>AFFW12006</b>	6 <sup>15</sup> / <sub>32</sub> • 8 <sup>31</sup> / <sub>32</sub> • 11 <sup>19</sup> / <sub>32</sub> • 13 <sup>7</sup> / <sub>16</sub> • 14 <sup>13</sup> / <sub>32</sub> • 14 <sup>15</sup> / <sub>64</sub>	2266965	2266967	2266969	2267411	9053366	9072780	9127959
<b>AFFW1201</b>	12 <sup>11</sup> / <sub>32</sub> • 14 <sup>31</sup> / <sub>32</sub> • 17 <sup>19</sup> / <sub>32</sub> • 19 <sup>7</sup> / <sub>16</sub> • 20 <sup>13</sup> / <sub>32</sub> • 20 <sup>15</sup> / <sub>64</sub>	2266971	2266973	2266975	2267412	9053368	9072782	9127961
<b>AFFW1202</b>	24 <sup>15</sup> / <sub>32</sub> • 27 <sup>3</sup> / <sub>32</sub> • 29 <sup>23</sup> / <sub>32</sub> • 31 <sup>9</sup> / <sub>16</sub> • 32 <sup>17</sup> / <sub>32</sub> • 32 <sup>32</sup> / <sub>64</sub>	2266977	2266979	2266981	2267413	9053370	9072784	9127963

# 400 Series Arch Windows (1989 to Present)

Standard Windows

## Grilles

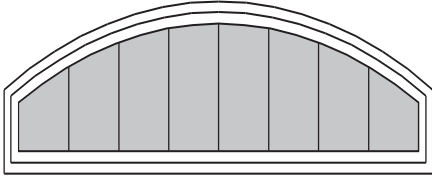
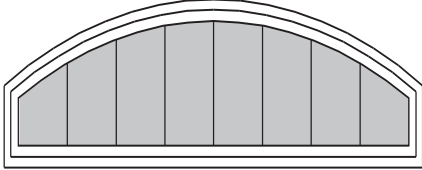
Interior Grille - Colonial / 7/8" Wood / Prefinished Interior (1-Piece)								
								
Unit No.	Dimensions (h)	Exterior						
		White	Terra-tone	Sand-tone	Forest Green	Canvas	Dark Bronze	Black
		Interior						
White	Terra-tone	Sand-tone	Forest Green	Canvas	Dark Bronze	Black		
<b>AFFW5006</b>	6 <sup>9</sup> / <sub>64</sub> • 8 <sup>7</sup> / <sub>16</sub> • 9 <sup>11</sup> / <sub>64</sub>	2263902	2264502	2265102	By description	9053323	9072737	9127916
<b>AFFW501</b>	12 <sup>9</sup> / <sub>64</sub> • 14 <sup>7</sup> / <sub>16</sub> • 15 <sup>11</sup> / <sub>64</sub>	2263904	2264504	2265104	By description	9053324	9072738	9127917
<b>AFFW6006</b>	7 <sup>1</sup> / <sub>16</sub> • 9 <sup>7</sup> / <sub>8</sub> • 10 <sup>25</sup> / <sub>64</sub>	2263924	2264524	2265124	By description	9053334	9072748	9127927
<b>AFFW601</b>	13 <sup>1</sup> / <sub>16</sub> • 15 <sup>7</sup> / <sub>8</sub> • 16 <sup>25</sup> / <sub>32</sub>	2263926	2264526	2265126	By description	9053335	9072749	9127928
<b>AFFW8006</b>	7 <sup>31</sup> / <sub>64</sub> • 11 <sup>9</sup> / <sub>64</sub> • 13 <sup>1</sup> / <sub>4</sub> • 13 <sup>61</sup> / <sub>64</sub>	2263946	2264546	2265146	By description	9053345	9072759	9127938
<b>AFFW801</b>	13 <sup>31</sup> / <sub>64</sub> • 17 <sup>9</sup> / <sub>64</sub> • 19 <sup>1</sup> / <sub>4</sub> • 19 <sup>61</sup> / <sub>64</sub>	2263948	2264548	2265148	By description	9053346	9072760	9127939
Interior Grille - Colonial / 7/8" Wood / Prefinished Interior (Vertical Pieces Only)								
								
Unit No.	Dimensions (h)	Exterior						
		White	Terra-tone	Sand-tone	Forest Green	Canvas	Dark Bronze	Black
		Interior						
White	Terra-tone	Sand-tone	Forest Green	Canvas	Dark Bronze	Black		
<b>AFFW12006</b>	6 <sup>15</sup> / <sub>32</sub> • 8 <sup>31</sup> / <sub>32</sub> • 11 <sup>19</sup> / <sub>32</sub> • 13 <sup>7</sup> / <sub>16</sub> • 14 <sup>13</sup> / <sub>32</sub> • 14 <sup>15</sup> / <sub>64</sub>	2266966	2266968	2266970	By description	9053367	9072781	9127960
<b>AFFW1201</b>	12 <sup>11</sup> / <sub>32</sub> • 14 <sup>31</sup> / <sub>32</sub> • 17 <sup>19</sup> / <sub>32</sub> • 19 <sup>7</sup> / <sub>16</sub> • 20 <sup>13</sup> / <sub>32</sub> • 20 <sup>15</sup> / <sub>64</sub>	2266972	2266974	2266976	By description	9053369	9072783	9127962
<b>AFFW1202</b>	24 <sup>15</sup> / <sub>32</sub> • 27 <sup>3</sup> / <sub>32</sub> • 29 <sup>23</sup> / <sub>32</sub> • 31 <sup>9</sup> / <sub>16</sub> • 32 <sup>17</sup> / <sub>32</sub> • 32 <sup>32</sup> / <sub>64</sub>	2266978	2266980	2266982	By description	9053371	9072785	9127964

## Grilles

### Interior Grilles - Renaissance

**Note:**  
Grilles include fasteners.

#### Interior Grille - Renaissance / 3/4" Wood / Natural Wood interior

Unit No.	Dimensions (w x h)	Exterior						
		White	Terratone	Sandtone	Forest Green	Canvas	Dark Bronze	Black
		Maple Interior						
<b>AFC12</b>	19 15/32 x 19 7/8	2265206	2265806	2266406	2267325	9053481	9072891	9128070
<b>AFC13</b>	19 15/32 x 31 11/16	2265208	2265808	2266408	2267326	9053482	9072892	9128071
<b>AFC135</b>	19 15/32 x 36 9/16	2265210	2265810	2266410	2267327	9053483	9072893	9128072
<b>AFC14</b>	19 15/32 x 43 3/4	2265212	2265812	2266412	2267328	9053484	9072894	9128073
<b>AFC145</b>	19 15/32 x 48 9/16	2265214	2265814	2266414	2267329	9053485	9072895	9128074
<b>AFC15</b>	19 15/32 x 55 5/8	2265216	2265816	2266416	2267330	9053486	9072896	9128075
<b>AFC155</b>	19 15/32 x 60 9/16	2265218	2265818	2266418	2267331	9053487	9072897	9128076
<b>AFC16</b>	19 15/32 x 67 5/8	2265220	2265820	2266420	2267332	9053488	9072898	9128077
<b>AFC18</b>	19 15/32 x 91 7/8	2265222	2265822	2266422	2267333	9053489	9072899	9128078
<b>AFCW12</b>	23 23/32 x 20 7/64	2265228	2265828	2266428	2267336	9053490	9072900	9128079
<b>AFCW13</b>	23 23/32 x 31 59/64	2265230	2265830	2266430	2267337	9053491	9072901	9128080
<b>AFCW135</b>	23 23/32 x 36 51/64	2265232	2265832	2266432	2267338	9053492	9072902	9128081
<b>AFCW14</b>	23 23/32 x 43 63/64	2265234	2265834	2266434	2267339	9053493	9072903	9128082
<b>AFCW145</b>	23 23/32 x 48 51/64	2265236	2265836	2266436	2267340	9053494	9072904	9128083
<b>AFCW15</b>	23 23/32 x 55 55/64	2265238	2265838	2266438	2267341	9053495	9072905	9128084
<b>AFCW155</b>	23 23/32 x 60 51/64	2265240	2265840	2266440	2267342	9053496	9072906	9128085
<b>AFCW16</b>	23 23/32 x 67 55/64	2265242	2265842	2266442	2267343	9053497	9072907	9128086
<b>AFCW18</b>	23 23/32 x 92 7/64	2265244	2265844	2266444	2267344	9053498	9072908	9128087
<b>AFCP302</b>	31 9/32 x 19 31/32	2265250	2265850	2266450	2267347	9053499	9072909	9128088
<b>AFCP303</b>	31 9/32 x 31 25/32	2265252	2265852	2266452	2267348	9053500	9072910	9128089
<b>AFCP3035</b>	31 9/32 x 36 21/32	2265254	2265854	2266454	2267349	9053501	9072911	9128090
<b>AFCP304</b>	31 9/32 x 43 27/32	2265256	2265856	2266456	2267350	9053502	9072912	9128091
<b>AFCP3045</b>	31 9/32 x 48 21/32	2265258	2265858	2266458	2267351	9053503	9072913	9128092
<b>AFCP305</b>	31 9/32 x 55 23/32	2265260	2265860	2266460	2267352	9053504	9072914	9128093
<b>AFCP3055</b>	31 9/32 x 60 21/32	2265262	2265862	2266462	2267353	9053505	9072915	9128094
<b>AFCP306</b>	31 9/32 x 67 23/32	2265264	2265864	2266464	2267354	9053506	9072916	9128095
<b>AFCP308</b>	31 9/32 x 91 31/32	2265266	2265866	2266466	2267355	9053507	9072917	9128096
<b>AFC22</b>	43 11/32 x 25 29/32	2265306	2265906	2266506	2267358	9053510	9072920	9128099
<b>AFC23</b>	43 11/32 x 37 23/32	2265308	2265908	2266508	2267359	9053511	9072921	9128100



# 400 Series Arch Windows (1989 to Present)

Standard Windows

## Grilles

Interior Grille - Renaissance / 3/4" Wood / Natural Wood interior								
Unit No.	Dimensions (w x h)	Exterior						
		White	Terratone	Sandtone	Forest Green	Canvas	Dark Bronze	Black
		Maple Interior						
<b>AFC235</b>	43 11/32 × 42 19/32	2265310	2265910	2266510	2267360	9053512	9072922	9128101
<b>AFC24</b>	43 11/32 × 49 25/32	2265312	2265912	2266512	2267361	9053513	9072923	9128102
<b>AFC245</b>	43 11/32 × 54 19/32	2265314	2265914	2266514	2267362	9053514	9072924	9128103
<b>AFC25</b>	43 11/32 × 61 21/32	2265316	2265916	2266516	2267363	9053515	9072925	9128104
<b>AFC255</b>	43 11/32 × 66 19/32	2265318	2265918	2266518	2267364	9053516	9072926	9128105
<b>AFC26</b>	43 11/32 × 73 21/32	2265320	2265920	2266520	2267365	9053517	9072927	9128106
<b>AFC28</b>	43 11/32 × 97 29/32	2265322	2265922	2266522	2267366	9053518	9072928	9128107
<b>AFCW22</b>	51 27/32 × 26 17/32	2265328	2265928	2266528	2267369	9053521	9072931	9128110
<b>AFCW23</b>	51 27/32 × 38 11/32	2265330	2265930	2266530	2267370	9053522	9072932	9128111
<b>AFCW235</b>	51 27/32 × 43 7/32	2265332	2265932	2266532	2267371	9053523	9072933	9128112
<b>AFCW24</b>	51 27/32 × 50 13/32	2265334	2265934	2266534	2267372	9053524	9072934	9128113
<b>AFCW245</b>	51 27/32 × 55 7/32	2265336	2265936	2266536	2267373	9053525	9072935	9128114
<b>AFCW25</b>	51 27/32 × 62 9/32	2265338	2265938	2266538	2267374	9053526	9072936	9128115
<b>AFCW255</b>	51 27/32 × 67 7/32	2265340	2265940	2266540	2267375	9053527	9072937	9128116
<b>AFCW26</b>	51 27/32 × 74 9/32	2265342	2265942	2266542	2267376	9053528	9072938	9128117
<b>AFCW28</b>	51 27/32 × 98 17/32	2265344	2265944	2266544	2267377	9053529	9072939	9128118

Interior Grille - Renaissance / 3/4" Wood / Prefinished Interior								
Unit No.	Dimensions (w x h)	Exterior						
		White	Terratone	Sandtone	Forest Green	Canvas	Dark Bronze	Black
		Interior						
		White	Terratone	Sandtone	Forest Green	Canvas	Dark Bronze	Black
<b>AFC12</b>	19 15/32 × 19 7/8	2265506	2266106	2266706	By description	9053562	9072972	9128151
<b>AFC13</b>	19 15/32 × 31 11/16	2265508	2266108	2266708	By description	9053563	9072973	9128152
<b>AFC135</b>	19 15/32 × 36 9/16	2265510	2266110	2266710	By description	9053564	9072974	9128153
<b>AFC14</b>	19 15/32 × 43 3/4	2265512	2266112	2266712	By description	9053565	9072975	9128154
<b>AFC145</b>	19 15/32 × 48 9/16	2265514	2266114	2266714	By description	9053566	9072976	9128155
<b>AFC15</b>	19 15/32 × 55 5/8	2265516	2266116	2266716	By description	9053567	9072977	9128156
<b>AFC155</b>	19 15/32 × 60 9/16	2265518	2266118	2266718	By description	9053568	9072978	9128157
<b>AFC16</b>	19 15/32 × 67 5/8	2265520	2266120	2266720	By description	9053569	9072979	9128158
<b>AFC18</b>	19 15/32 × 91 7/8	2265522	2266122	2266722	By description	9053570	9072980	9128159
<b>AFCW12</b>	23 23/32 × 20 7/64	2265528	2266128	2266728	By description	9053571	9072981	9128160

## Grilles

Interior Grille - Renaissance / 3/4" Wood / Prefinished Interior								
Unit No.	Dimensions (w x h)	Exterior						
		White	Terratone	Sandtone	Forest Green	Canvas	Dark Bronze	Black
		Interior						
		White	Terratone	Sandtone	Forest Green	Canvas	Dark Bronze	Black
AFCW13	23 23/32 x 31 59/64	2265530	2266130	2266730	By description	9053572	9072982	9128161
AFCW135	23 23/32 x 36 51/64	2265532	2266132	2266732	By description	9053573	9072983	9128162
AFCW14	23 23/32 x 43 63/64	2265534	2266134	2266734	By description	9053574	9072984	9128163
AFCW145	23 23/32 x 48 51/64	2265536	2266136	2266736	By description	9053575	9072985	9128164
AFCW15	23 23/32 x 55 55/64	2265538	2266138	2266738	By description	9053576	9072986	9128165
AFCW155	23 23/32 x 60 51/64	2265540	2266140	2266740	By description	9053577	9072987	9128166
AFCW16	23 23/32 x 67 55/64	2265542	2266142	2266742	By description	9053578	9072988	9128167
AFCW18	23 23/32 x 92 7/64	2265544	2266144	2266744	By description	9053579	9072989	9128168
AFCP302	31 9/32 x 19 31/32	2265550	2266150	2266750	By description	9053581	9072991	9128170
AFCP303	31 9/32 x 31 25/32	2265552	2266152	2266752	By description	9053582	9072992	9128171
AFCP3035	31 9/32 x 36 21/32	2265554	2266154	2266754	By description	9053583	9072993	9128172
AFCP304	31 9/32 x 43 27/32	2265556	2266156	2266756	By description	9053584	9072994	9128173
AFCP3045	31 9/32 x 48 21/32	2265558	2266158	2266758	By description	9053585	9072995	9128174
AFCP305	31 9/32 x 55 23/32	2265560	2266160	2266760	By description	9053586	9072996	9128175
AFCP3055	31 9/32 x 60 21/32	2265562	2266162	2266762	By description	9053587	9072997	9128176
AFCP306	31 9/32 x 67 23/32	2265564	2266164	2266764	By description	9053588	9072998	9128177
AFCP308	31 9/32 x 91 31/32	2265566	2266166	2266766	By description	9053589	9072999	9128178
AFC22	43 11/32 x 25 29/32	2265606	2266206	2266806	By description	9053592	9073002	9128181
AFC23	43 11/32 x 37 23/32	2265608	2266208	2266808	By description	9053593	9073003	9128182
AFC235	43 11/32 x 42 19/32	2265610	2266210	2266810	By description	9053594	9073004	9128183
AFC24	43 11/32 x 49 25/32	2265612	2266212	2266812	By description	9053595	9073005	9128184
AFC245	43 11/32 x 54 19/32	2265614	2266214	2266814	By description	9053596	9073006	9128185
AFC25	43 11/32 x 61 21/32	2265616	2266216	2266816	By description	9053597	9073007	9128186
AFC255	43 11/32 x 66 19/32	2265618	2266218	2266818	By description	9053598	9073008	9128187
AFC26	43 11/32 x 73 21/32	2265620	2266220	2266820	By description	9053599	9073009	9128188
AFC28	43 11/32 x 97 29/32	2265622	2266222	2266822	By description	9053600	9073010	9128189
AFCW22	51 27/32 x 26 17/32	2265628	2266228	2266828	By description	9053603	9073013	9128192
AFCW23	51 27/32 x 38 11/32	2265630	2266230	2266830	By description	9053604	9073014	9128193
AFCW235	51 27/32 x 43 7/32	2265632	2266232	2266832	By description	9053605	9073015	9128194
AFCW24	51 27/32 x 50 13/32	2265634	2266234	2266834	By description	9053606	9073016	9128195
AFCW245	51 27/32 x 55 7/32	2265636	2266236	2266836	By description	9053607	9073017	9128196
AFCW25	51 27/32 x 62 9/32	2265638	2266238	2266838	By description	9053608	9073018	9128197
AFCW255	51 27/32 x 67 7/32	2265640	2266240	2266840	By description	9053609	9073019	9128198
AFCW26	51 27/32 x 74 9/32	2265642	2266242	2266842	By description	9053610	9073020	9128199
AFCW28	51 27/32 x 98 17/32	2265644	2266244	2266844	By description	9053611	9073021	9128200

# 400 Series Arch Windows (1989 to Present)

Standard Windows

## Grilles

Interior Grille - Renaissance / 7/8" Wood / Natural Wood interior								
Unit No.	Dimensions (w x h)	White	Terratone	Sandtone	Forest Green	Canvas	Dark Bronze	Black
		Maple Interior						
		Maple Interior						
AFFW502	54 <sup>19</sup> / <sub>32</sub> × 27 <sup>9</sup> / <sub>32</sub>	2265406	2266006	2266606	2267380	9053532	9072942	9128121
AFFW503	54 <sup>19</sup> / <sub>32</sub> × 39 <sup>3</sup> / <sub>32</sub>	2265408	2266008	2266608	2267381	9053533	9072943	9128122
AFFW5035	54 <sup>19</sup> / <sub>32</sub> × 43 <sup>31</sup> / <sub>32</sub>	2265410	2266010	2266610	2267382	9053534	9072944	9128123
AFFW504	54 <sup>19</sup> / <sub>32</sub> × 51 <sup>5</sup> / <sub>32</sub>	2265412	2266012	2266612	2267383	9053535	9072945	9128124
AFFW5045	54 <sup>19</sup> / <sub>32</sub> × 55 <sup>31</sup> / <sub>32</sub>	2265414	2266014	2266614	2267384	9053536	9072946	9128125
AFFW505	54 <sup>19</sup> / <sub>32</sub> × 63 <sup>1</sup> / <sub>32</sub>	2265416	2266016	2266616	2267385	9053537	9072947	9128126
AFFW5055	54 <sup>19</sup> / <sub>32</sub> × 67 <sup>31</sup> / <sub>32</sub>	2265418	2266018	2266618	2267386	9053538	9072948	9128127
AFFW506	54 <sup>19</sup> / <sub>32</sub> × 75 <sup>1</sup> / <sub>32</sub>	2265420	2266020	2266620	2267387	9053539	9072949	9128128
AFFW508	54 <sup>19</sup> / <sub>32</sub> × 99 <sup>25</sup> / <sub>32</sub>	2265422	2266022	2266622	2267388	9053540	9072950	9128129
AFFW602	66 <sup>19</sup> / <sub>32</sub> × 28 <sup>29</sup> / <sub>32</sub>	2265428	2266028	2266628	2267391	9053543	9128132	9128132
AFFW603	66 <sup>19</sup> / <sub>32</sub> × 40 <sup>23</sup> / <sub>32</sub>	2265430	2266030	2266630	2267392	9053544	9128133	9128133
AFFW6035	66 <sup>19</sup> / <sub>32</sub> × 45 <sup>19</sup> / <sub>32</sub>	2265432	2266032	2266632	2267393	9053545	9128134	9128134
AFFW604	66 <sup>19</sup> / <sub>32</sub> × 52 <sup>25</sup> / <sub>32</sub>	2265434	2266034	2266634	2267394	9053546	9128135	9128135
AFFW6045	66 <sup>19</sup> / <sub>32</sub> × 57 <sup>19</sup> / <sub>32</sub>	2265436	2266036	2266636	2267395	9053547	9128136	9128136
AFFW605	66 <sup>19</sup> / <sub>32</sub> × 64 <sup>21</sup> / <sub>32</sub>	2265438	2266038	2266638	2267396	9053548	9128137	9128137
AFFW6055	66 <sup>19</sup> / <sub>32</sub> × 69 <sup>19</sup> / <sub>32</sub>	2265440	2266040	2266640	2267397	9053549	9128138	9128138
AFFW606	66 <sup>19</sup> / <sub>32</sub> × 76 <sup>21</sup> / <sub>32</sub>	2265442	2266042	2266642	2267398	90535450	9128139	9128139
AFFW608	66 <sup>19</sup> / <sub>32</sub> × 100 <sup>29</sup> / <sub>32</sub>	2265444	2266044	2266644	2267399	90535451	9128140	9128140
AFFW802	90 <sup>15</sup> / <sub>32</sub> × 32 <sup>3</sup> / <sub>32</sub>	2265450	2266050	2266650	2267403	9053554	9072964	9128143
AFFW803	90 <sup>15</sup> / <sub>32</sub> × 43 <sup>29</sup> / <sub>32</sub>	2265452	2266052	2266652	2267404	9053555	9072965	9128144
AFFW8035	90 <sup>15</sup> / <sub>32</sub> × 44 <sup>25</sup> / <sub>32</sub>	2265454	2266054	2266654	2267405	9053556	9072966	9128145
AFFW804	90 <sup>15</sup> / <sub>32</sub> × 55 <sup>31</sup> / <sub>32</sub>	2265456	2266056	2266656	2267406	9053557	9072967	9128146
AFFW8045	90 <sup>15</sup> / <sub>32</sub> × 60 <sup>25</sup> / <sub>32</sub>	2265458	2266058	2266658	2267407	9053558	9072968	9128147
AFFW805	90 <sup>15</sup> / <sub>32</sub> × 67 <sup>27</sup> / <sub>32</sub>	2265460	2266060	2266660	2267408	9053559	9072969	9128148
AFFW8055	90 <sup>15</sup> / <sub>32</sub> × 72 <sup>25</sup> / <sub>32</sub>	2265462	2266062	2266662	2267409	9053560	9072970	9128149
AFFW806	90 <sup>15</sup> / <sub>32</sub> × 79 <sup>27</sup> / <sub>32</sub>	2265464	2266064	2266664	2267410	9053561	9072971	9128150

## Grilles

Interior Grille - Renaissance / 7/8" Wood / Prefinished Interior								
Unit No.	Dimensions (w x h)	Exterior						
		White	Terratone	Sandtone	Forest Green	Canvas	Dark Bronze	Black
		Interior						
		White	Terratone	Sandtone	Forest Green	Canvas	Dark Bronze	Black
AFFW502	54 19/32 x 27 9/32	2265706	2266306	2266906	By description	9053614	9073024	9128203
AFFW503	54 19/32 x 39 3/32	2265708	2266308	2266908	By description	9053615	9073025	9128204
AFFW5035	54 19/32 x 43 31/32	2265710	2266310	2266910	By description	9053616	9073026	9128205
AFFW504	54 19/32 x 51 5/32	2265712	2266312	2266912	By description	9053617	9073027	9128206
AFFW5045	54 19/32 x 55 31/32	2265714	2266314	2266914	By description	9053618	9073028	9128207
AFFW505	54 19/32 x 63 1/32	2265716	2266316	2266916	By description	9053619	9073029	9128208
AFFW5055	54 19/32 x 67 31/32	2265718	2266318	2266918	By description	9053620	9073030	9128209
AFFW506	54 19/32 x 75 1/32	2265720	2266320	2266920	By description	9053621	9073031	9128210
AFFW508	54 19/32 x 99 25/32	2265722	2266322	2266922	By description	9053622	9073032	9128211
AFFW602	66 19/32 x 28 29/32	2265728	2266328	2266928	By description	9053472	9072882	9128061
AFFW603	66 19/32 x 40 23/32	2265730	2266330	2266930	By description	9053473	9072883	9128062
AFFW6035	66 19/32 x 45 19/32	2265732	2266332	2266932	By description	9053474	9072884	9128063
AFFW604	66 19/32 x 52 25/32	2265734	2266334	2266934	By description	9053475	9072885	9128064
AFFW6045	66 19/32 x 57 19/32	2265736	2266336	2266936	By description	9053476	9072886	9128065
AFFW605	66 19/32 x 64 21/32	2265738	2266338	2266938	By description	9053477	9072887	9128066
AFFW6055	66 19/32 x 69 19/32	2265740	2266340	2266940	By description	9053478	9072888	9128067
AFFW606	66 19/32 x 76 21/32	2265742	2266342	2266942	By description	9053479	9072889	9128068
AFFW608	66 19/32 x 100 29/32	2265744	2266344	2266944	By description	9053480	9072890	9128069
AFFW802	90 15/32 x 32 3/32	2265750	2266350	2266950	By description	9053632	9073037	9128216
AFFW803	90 15/32 x 43 29/32	2265752	2266352	2266952	By description	9053633	9073038	9128217
AFFW8035	90 15/32 x 44 25/32	2265754	2266354	2266954	By description	9053634	9073039	9128218
AFFW804	90 15/32 x 55 31/32	2265756	2266356	2266956	By description	9053635	9073040	9128219
AFFW8045	90 15/32 x 60 25/32	2265758	2266358	2266958	By description	9053636	9073041	9128220
AFFW805	90 15/32 x 67 27/32	2265760	2266360	2266960	By description	9053637	9073042	9128221
AFFW8055	90 15/32 x 72 25/32	2265762	2266362	2266962	By description	9053638	9073043	9128222
AFFW806	90 15/32 x 79 27/32	2265764	2266364	2266964	By description	9053639	9073044	9128223

# 400 Series Arch Windows (1989 to Present)

Standard Windows

## Grilles

### Interior Grilles - Sunburst

**Note:**

Grilles include fasteners.

### Interior Grille - Sunburst / 3/4" Wood / Natural Wood Interior

Unit No.	Dimensions (w x h)	Exterior						
		White	Terratone	Sandtone	Forest Green	Canvas	Dark Bronze	Black
		Maple Interior						
AFC106	11 <sup>21</sup> / <sub>64</sub> × 3 <sup>13</sup> / <sub>16</sub>	2265202	2265802	2266402	2267323	9053355	9072769	9127948
AFC11	19 <sup>7</sup> / <sub>16</sub> × 10 <sup>19</sup> / <sub>32</sub>	2265204	2265804	2266404	2267324	9053356	9072770	9127949
AFCW106	14 <sup>11</sup> / <sub>64</sub> × 4 <sup>25</sup> / <sub>32</sub>	2265224	2265824	2266424	2267334	9053357	9072771	9127950
AFCW11	23 <sup>54</sup> / <sub>64</sub> × 11 <sup>63</sup> / <sub>64</sub>	2265226	2265826	2266426	2267335	9053358	9072772	9127951
AFCP3006	15 <sup>1</sup> / <sub>2</sub> × 5 <sup>7</sup> / <sub>32</sub>	2265246	2265846	2266446	2267345	9053359	9072773	9127952
AFCP301	31 <sup>17</sup> / <sub>64</sub> × 11 <sup>45</sup> / <sub>64</sub>	2265248	2265848	2266448	2267346	9053360	9072774	9127953
AFC206	28 <sup>1</sup> / <sub>2</sub> × 7 <sup>25</sup> / <sub>32</sub>	2265302	2265902	2266502	2267356	9053508	9072918	9128097
AFC21	43 <sup>11</sup> / <sub>32</sub> × 13 <sup>49</sup> / <sub>64</sub>	2265304	2265904	2266504	2267357	9053509	9072919	9128098
AFCW206	31 <sup>59</sup> / <sub>64</sub> × 8 <sup>1</sup> / <sub>8</sub>	2265324	2265924	2266524	2267367	9053519	9072929	9128108
AFCW21	51 <sup>27</sup> / <sub>32</sub> × 8 <sup>27</sup> / <sub>32</sub>	2265326	2265926	2266526	2267368	9053520	9072930	9128109

### Interior Grille - Sunburst / 3/4" Wood / Prefinished Interior

Unit No.	Dimensions (w x h)	Exterior						
		White	Terratone	Sandtone	Forest Green	Canvas	Dark Bronze	Black
		Interior						
		White	Terratone	Sandtone	Forest Green	Canvas	Dark Bronze	Black
AFC106	11 <sup>21</sup> / <sub>64</sub> × 3 <sup>13</sup> / <sub>16</sub>	2265502	2266102	2266702	By description	9053361	9072775	9127954
AFC11	19 <sup>7</sup> / <sub>16</sub> × 10 <sup>19</sup> / <sub>32</sub>	2265504	2266104	2266704	By description	9053362	9072776	9127955
AFCW106	14 <sup>11</sup> / <sub>64</sub> × 4 <sup>25</sup> / <sub>32</sub>	2265524	2266124	2266724	By description	9053363	9072777	9127956
AFCW11	23 <sup>54</sup> / <sub>64</sub> × 11 <sup>63</sup> / <sub>64</sub>	2265526	2266126	2266726	By description	9053364	9072778	9127957
AFCP3006	15 <sup>1</sup> / <sub>2</sub> × 5 <sup>7</sup> / <sub>32</sub>	2265546	2266146	2266746	By description	9053365	9072779	9127958
AFCP301	31 <sup>17</sup> / <sub>64</sub> × 11 <sup>45</sup> / <sub>64</sub>	2265548	2266148	2266748	By description	9053580	9072990	9128169
AFC206	28 <sup>1</sup> / <sub>2</sub> × 7 <sup>25</sup> / <sub>32</sub>	2265602	2266202	2266802	By description	9053590	9073000	9128179
AFC21	43 <sup>11</sup> / <sub>32</sub> × 13 <sup>49</sup> / <sub>64</sub>	2265604	2266204	2266804	By description	9053591	9073001	9128180
AFCW206	31 <sup>59</sup> / <sub>64</sub> × 9 <sup>27</sup> / <sub>32</sub>	2265624	2266224	2266824	By description	9053601	9073011	9128190
AFCW21	51 <sup>27</sup> / <sub>32</sub> × 8 <sup>27</sup> / <sub>32</sub>	2265626	2266226	2266826	By description	9053601	9073012	9128191

## Grilles

Interior Grille - Sunburst / 7/8" Wood / Natural Wood Interior								
Unit No.	Dimensions (w x h)	Exterior						
		White	Terratone	Sandtone	Forest Green	Canvas	Dark Bronze	Black
		Maple Interior						
AFFW5006	40 1/2 x 8 23/32	2265402	2266002	2266602	2267378	9053530	9072940	9128119
AFFW501	54 19/32 x 15 11/64	2265404	2266004	2266604	2267379	9053531	9072941	9128120
AFFW6006	49 5/16 x 10 25/32	2265424	2266024	2266624	2267389	9053541	9072951	9128130
AFFW601	66 19/32 x 16 27/64	2265426	2266026	2266626	2267390	9053542	9072952	9128131
AFFW8006	66 47/64 x 31 61/64	2265446	2266046	2266646	2267401	9053552	9072962	9128141
AFFW801	90 15/32 x 19 61/64	2265448	2266048	2266648	2267402	9053553	9072963	9128142

Interior Grille - Sunburst / 7/8" Wood / Prefinished Interior								
Unit No.	Dimensions (w x h)	Exterior						
		White	Terratone	Sandtone	Forest Green	Canvas	Dark Bronze	Black
		Interior						
		White	Terratone	Sandtone	Forest Green	Canvas	Dark Bronze	Black
AFFW5006	40 1/2 x 8 23/32	2265702	2266302	2266902	By description	9053612	9073022	9128201
AFFW501	54 19/32 x 15 11/64	2265704	2266304	2266904	By description	9053613	9073023	9128202
AFFW6006	49 5/16 x 10 25/32	2265724	2266324	2266924	By description	9053623	9073033	9128212
AFFW601	66 19/32 x 16 27/64	2265726	2266326	2266926	By description	9053624	9073034	9128213
AFFW8006	66 47/64 x 31 61/64	2265746	2266346	2266946	By description	9053625	9073035	9128214
AFFW801	90 15/32 x 19 61/64	2265748	2266348	2266948	By description	9053626	9073036	9128215

## Grille Fasteners

Interior Grille Fastener - Barbed	
<b>Note:</b> Used on products with a wood stop next to glass.	<b>Order No.</b> 1974314

## Frames

### Frame Assembly

Note:

See latest [Product Details](#).

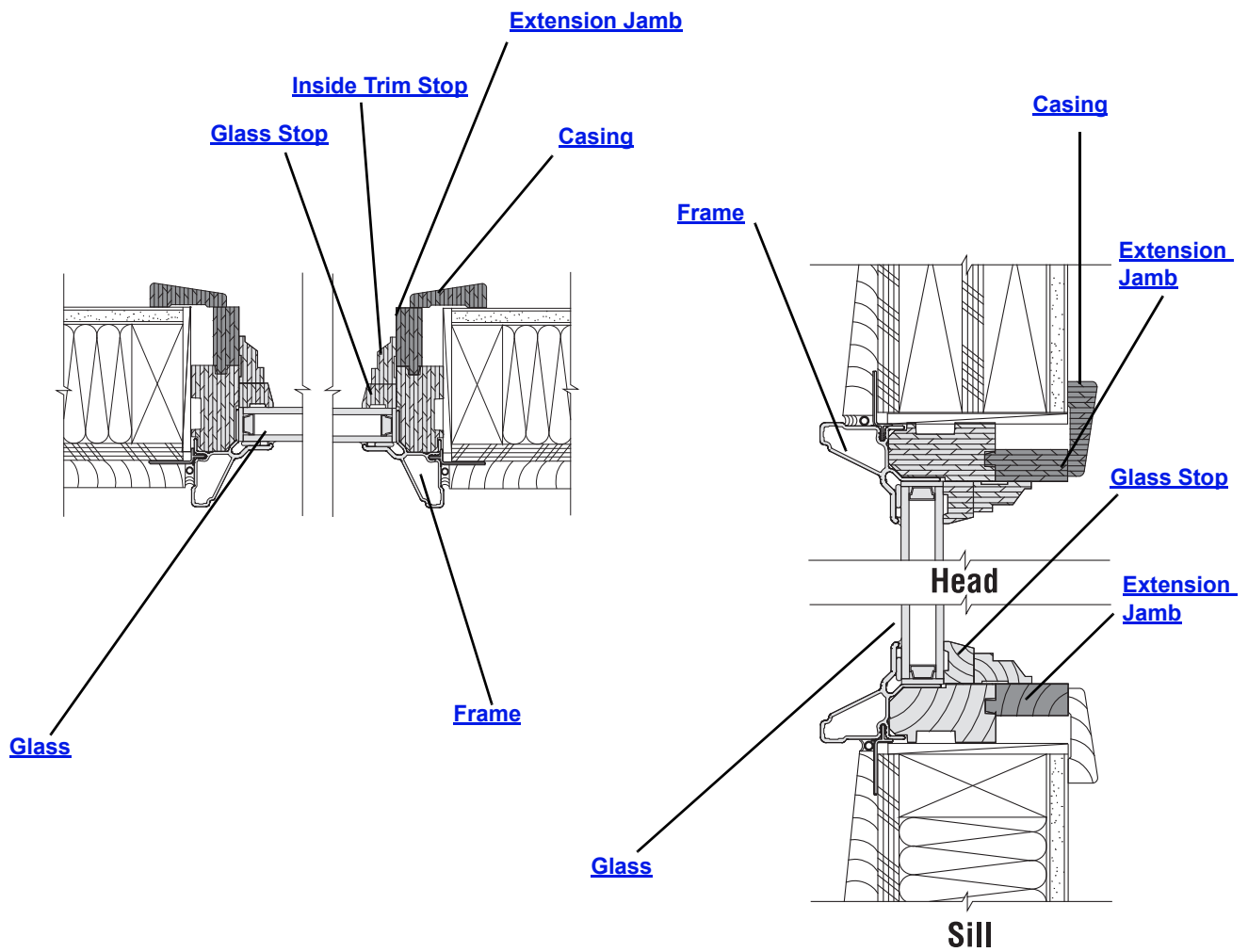

Arch Window Frame Assembly

## Frames

### Stops

#### Trim Stop - Arch

	<b>Description</b>	<b>Pine</b>	<b>Prefinished Interior White</b>
	2' - 72°	2230052	6032101
	3' - 72°	2230053	6032106
	4' - 72°	2230054	6032111
	5' - 72°	2230055	6032116
	6' - 72°	2230056	6032121
	8' - 72°	2230058	6032192
	16' - 72°	2230059	6032131

#### Trim Stop - Lineal

	<b>Length</b>	<b>Pine</b>	<b>White</b>	<b>Terra-tone®</b>	<b>Sandtone</b>	<b>Forest Green</b>	<b>Canvas</b>	<b>Prairie Grass</b>
	22	2230087	2233055	9185203	9185189	9185259	9185245	9185287
	46	2230088	2233056	9185204	9185190	9185260	9185246	9185288
	70	2230089	2233057	9185205	9185191	9185261	9185247	9185289
	80	2230093	9055292	9185208	9185194	9185264	9185250	9185292
	94	2230090	2233058	9185206	9185192	9185262	9185248	9185290
	142	2230091	2233059	9185207	9185193	9185263	9185249	9185291
	<b>Length</b>	<b>Cocoa Bean</b>	<b>Dove Gray</b>	<b>Red Rock</b>	<b>Dark Bronze</b>	<b>Black</b>		
	22	9185315	9185273	9185301	9185231	9185217		
	46	9185316	9185274	9185302	9185232	9185218		
	70	9185317	9185275	9185303	9185233	9185219		
	80	9185320	9185278	9185306	9185236	9185222		
	94	9185318	9185276	9185304	9185234	9185220		
	142	9185319	9185277	9185305	9185235	9185221		

#### Key Component Block

	<b>Unit No.</b>	<b>Maple</b>	<b>Oak</b>
	<b>All Units</b>	2231110	2231112

#### Transition Block - Inside Stop

	<b>Unit No.</b>	<b>Order No.</b>
	All Units	2250110



# 400 Series Arch Windows (1989 to Present)

Standard Windows

## Frames

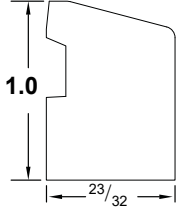
Glass Stop - Arch			
	Description	Natural Wood	Prefinished Interior White
	2' - 72°	2230062	6033101
	3' - 72°	2230063	6033106
	4' - 72°	2230064	6033111
	5' - 72°	2230065	6033116
	6' - 72°	2230066	6033121
	8' - 72°	2230068	6033126
	16' - 72°	2230069	6033131

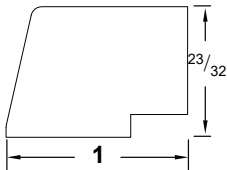
Glass Stop - Lineal									
	Length	Natural	White	Terra-tone®	Sandtone	Forest Green	Canvas	Prairie Grass	
	22	2230082	2233050	9185055	9185041	9185111	9185097	9185139	
	46	2230083	2233051	9185056	9185042	9185112	9185098	9185140	
	70	2230084	2233052	9185057	9185043	9185113	9185099	9185141	
	80	2230092	9055293	9185060	9185046	9185116	9185102	9185144	
	94	2230085	2233053	9185058	9185044	9185114	9185100	9185142	
	142	2230086	2233054	9185059	9185045	9185115	9185101	9185143	
	Length	Cocoa Bean	Dove Gray	Red Rock	Dark Bronze	Black			
	22	9185167	9185125	9185153	9185083	9185069			
	46	9185168	9185126	9185154	9185084	9185070			
	70	9185169	9185127	9185155	9185085	9185071			
	80	9185172	9185130	9185158	9185088	9185074			
	94	9185170	9185128	9185156	9185086	9185072			
	142	9185171	9185129	9185157	9185087	9185073			

Flanges		
Flange - Arch / Nailing		
	Length	Order No.
	156	8240605
Flange - Installation		
	Length	Order No.
	74	8240606
	150	8240607

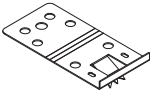
Installation Kits for Standard and Impact Resistant Units		
Jamb Clip Kit - 3"		
	<b>Kit includes:</b> (18) jamb clips (36) 8-18 x 1-1/4 PH FL 316 SS PASS TYP AB screws 1 instruction sheet	Order No.

## Frames

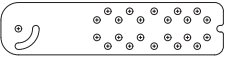
Jamb Clip Kit - 6" (for units with pre-applied extension jambs)				
	<p><b>Kit includes:</b> Jamb clips and screws for Tilt-Wash Double-Hung Picture IR window, Casement Picture window, Flexiframe window, Arch window.</p> <p><b>Note:</b> For use with pre-applied extension jambs. Made of 304 annealed stainless steel, making it compatible with ACQ treated lumber. These clips are approved for use with all Stormwatch products and for Miami-Dade County. The clips are pre-punched with holes for unit installation in wall thicknesses from 4-9/16" to 7-1/8". Additional pre-punched holes are available to compensate for wall thickness variations.</p>	Quantity	Clip Dimensions	Order No.
		18 clips	6 3/8 x 1 1/2	9014868

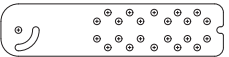
Jamb Clips - 6" (for units with pre-applied extension jambs)				
		Quantity	Clip Dimensions	Order No.
		500 clips	6 3/8 x 1 1/2	1376707

# 400 Series Arch Windows (1989 to Present)

Standard Windows

## Optional Components

### Inside Casing

Note:

See [Accessory Guide 005074](#).

### Inside Casing - Arch / Colonial with Plinth Blocks

Note:

R refers to the radius of the arch unit.

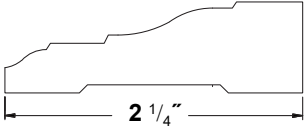
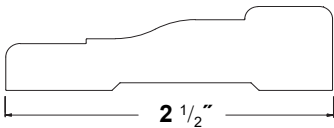
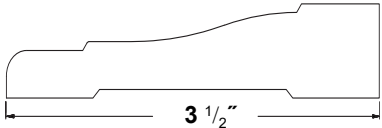
Unit No.	2 1/4			2 1/2			3 1/2		
									
	WM366			WM351			WM444		
	Pine	Maple	Oak	Pine	Maple	Oak	Pine	Maple	Oak
R2/RW2	9074084	2230204	2230304	9074098	2230404	N/A	9074112	2231004	2230904
R3	9074085	2230206	2230306	9074099	2230406	N/A	9074113	2231006	2230906
R4	9074086	2230210	2230310	9074100	2230410	N/A	9074114	2231010	2230910
R5/RW5	9074087	2230214	2230314	9074101	2230414	N/A	9074115	2231014	2230914
R6	9074088	2230216	2230316	9074102	2230416	N/A	9074116	2231016	2230916
R8	9074089	2230218	2230318	9074103	2230418	N/A	9074117	2231018	2230918
R16	9074090	2231020	2231022	9074104	2231024	N/A	9074118	2231026	2231027

### Inside Casing - Arch / Ranch with Plinth Blocks

Note:

R refers to the radius of the arch unit.

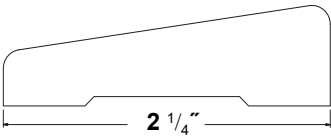
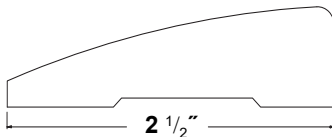
Unit No.	2 1/4			2 1/2		
						
	WM324			WM315		
	Pine	Maple	Oak	Pine	Maple	Oak
R2/RW2	9074091	2230504	2230604	9074105	2230704	N/A
R3	9074092	2230506	2230606	9074106	2230706	N/A
R4	9074093	2230510	2230610	9074107	2230710	N/A
R5/RW5	9074094	2230514	2230614	9074108	2230714	N/A
R6	9074095	2230516	2230616	9074109	2230716	N/A
R8	9074096	2230518	2230618	9074110	2230718	N/A
R16	9074097	2231021	2231023	9074111	2231025	N/A

## Optional Components

### Extension Jamb

#### Extensions Jamb - Lineal

**Note:**

Non-arch extension jambs are available in 4 9/16", 5 1/4", 6 9/16" and 7 1/8" widths. As of April 1995, 7 9/16" width was replaced with 7 1/8".

Size	Dim B
4 9/16"	1 63/64
5 1/4"	2 41/64
6 9/16"	3 63/64
7 1/8"	4 33/64

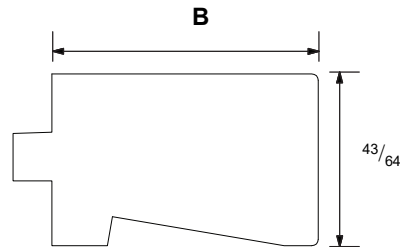

**Note:**

If part is NA use painted as a replacement.

Finish	8'				12'			
	4 9/16"	5 1/4"	6 9/16"	7 1/8"	4 9/16"	5 1/4"	6 9/16"	7 1/8"
Natural Wood	1349832	1350018	1349932	1349734	1349834	1350020	1349934	1349736
White (Vinyl Wrapped)	0701598	0701622	0701645	NA	0701599	0701623	0701646	NA
White (Painted)	1354654	1354683	1354625	1354713	1354655	1354684	1354626	1354714
Sandtone (Painted)	9069008	9069012	9069010	9069006	9069009	9069013	9069011	9069007

#### Extension Jamb - Arch

**Note:**

\*Use two arch extension jambs on AFFW12 unit.

Unit No.	4 9/16" Wall		5 1/4" Wall		6 9/16" Wall		7 1/8" Wall	
	Natural Wood	White	Natural Wood	White	Natural Wood	White	Natural Wood	White
AFFW12*	2234951	2235107	2234952	2235114	2234953	2235121	2234950	2235128
AFC1/AFCW1	2235002	2235101	2235014	2235108	2235026	2235115	2234944	2235122
AFCP3	2235004	2235102	2235016	2235109	2235028	2235116	2234945	2235123
AFC2	2235006	2235103	2235018	2235110	2235030	2235117	2234946	2235124
AFCW2/AFFW5	2235008	2235104	2235020	2235111	2235032	2235118	2234947	2235125
AFFW6	2235010	2235105	2235022	2235112	2235034	2235119	2234948	2235126
AFFW8	2235012	2235106	2235024	2235113	2235036	2235120	2234949	2235127

## 400 Series Arch Windows (1989 to Present)

*Standard Windows*

### Optional Components

Extension Jamb - Arch / Narroline				
<b>Note:</b> Use for Arch Top Narroline units		Prefinished White Interior		
	Unit No.	5 1/4" Wall	6 9/16" Wall	7 1/8" Wall
	<b>ATN24</b>	6019800	6019805	6019810
	<b>ATN28/30</b>	6019815	6019820	6019825

Extension Jamb - Arch / Casement			
<b>Note:</b> Use for Arch Top Casement units		Prefinished White Interior	
	Unit No.	5 1/4" Wall	7 1/8" Wall
	<b>AC54/60</b>	6035002	6037002

Transition Block - Extension Jamb		
<b>Note:</b> See <a href="#">Accessory Guide 0005073</a> .		
	<b>Note:</b> For units 48" radius and larger; all extension jamb depths. Transition block may need to be cut, dependent on extension jamb depth. Fasten with 1" finishing nails.  For 4 9/16" and 5 1/4", order one block per two transitions. For 6 9/16" and 7 1/8", order two blocks per two transitions.	<b>Order No.</b> 2250112



## Optional Components

### Drywall Return Bead

#### Drywall Return Bead - Curved Wide

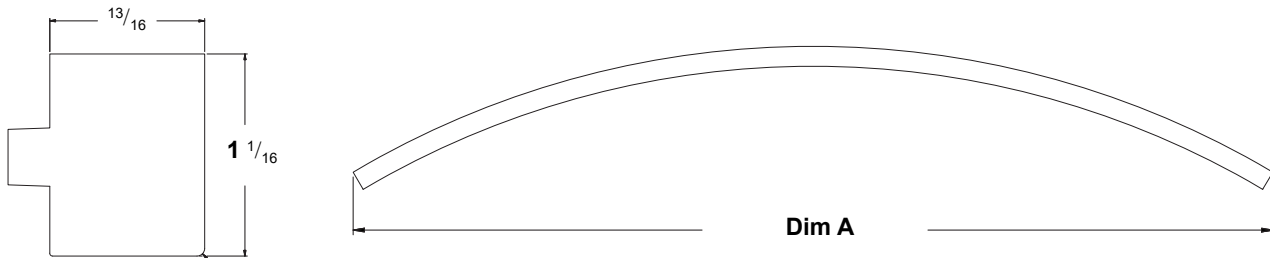
Note:



	AFF R2	AFF R3	AFF R4	AFF R5	AFF R6	AC60	AFF R8	AFF R16
Finish	Dim A							
	29 <sup>5</sup> / <sub>16</sub> "	36 <sup>23</sup> / <sub>32</sub> "	48 <sup>25</sup> / <sub>32</sub> "	60"	72 <sup>21</sup> / <sub>32</sub> "	72 <sup>11</sup> / <sub>16</sub> "	95 <sup>15</sup> / <sub>16</sub> "	77 <sup>1</sup> / <sub>4</sub> "
Pine 	9117496	9117498	9117500	9117502	9117504	9117467	9117506	9117494
White 	9117497	9117499	9117501	9117503	9117505	9117466	9117507	9117495

# 400 Series Arch Windows (1989 to Present)

Standard Windows

## Optional Components

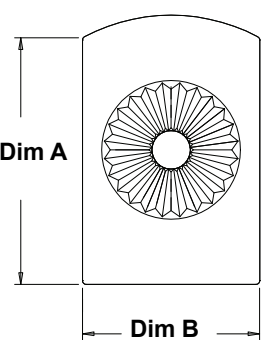
Trim Parts																	
Plinth Blocks - Arch																	
	<table border="1"> <thead> <tr> <th></th> <th>Dim A</th> <th>Dim B</th> </tr> </thead> <tbody> <tr> <td>2 7/8"</td> <td>4</td> <td>2 7/8</td> </tr> <tr> <td>3 7/8"</td> <td>5 1/4</td> <td>3 7/8</td> </tr> </tbody> </table>		Dim A	Dim B	2 7/8"	4	2 7/8	3 7/8"	5 1/4	3 7/8	Unit No.	2 7/8"			3 7/8"		
			Dim A	Dim B													
		2 7/8"	4	2 7/8													
3 7/8"	5 1/4	3 7/8															
All Units	Pine	Maple	Oak	Pine	Maple	Oak											
	9074429	2230808	2230804	9074430	2231108	2231106											

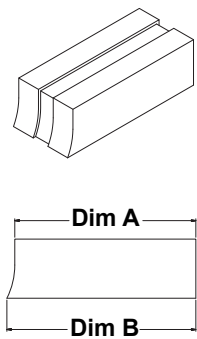
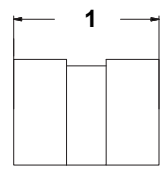
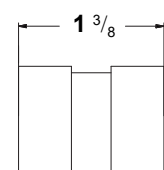
Block - Transition Casing						
	<b>Narrow</b>					
						
	2 1/4" and 2 1/2"			3 1/2"		
	Pine	Maple	Oak	Pine	Maple	Oak
	9074415	2231116	2231117	9074416	2231118	2231119
<b>Wide</b>						
						
2 1/4" and 2 1/2"			3 1/2"			
Pine	Maple	Oak	Pine	Maple	Oak	
9074417	2231120	2231121	9074418	2231122	2231123	
	Dim A	Dim B				
2 1/4"	3 3/64	3 11/64				
2 1/2"						
3 1/2"	4 11/64	4 19/64				

## Joining Components

### Narrow Mullion

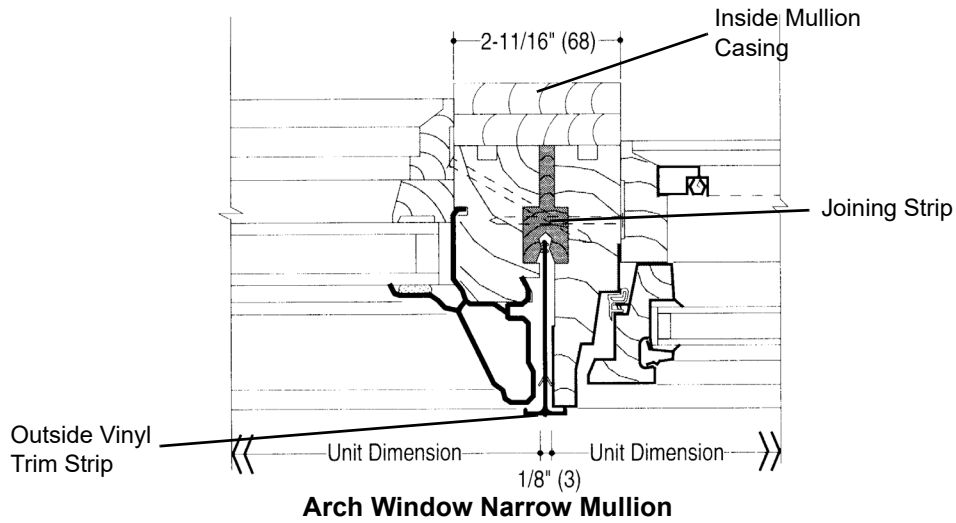

### Exterior Trim Strip - Narrow Mullion

	Length	Color	Order No.
	144"	White	1348520
		Terratone	1448520
		Sandtone	0607234
		Forest Green	0514105
		Canvas	9033596
		Dark Bronze	9073196
		Black	9129227

### Inside Casing - Narrow Mullion / Natural Wood

	Length	2 5/8" Casement/ Flexiframe	2 7/8" Flexiframe/ Flexiframe
	96"	1386812	1507622
	144"	1386814	1507624

### Exterior Flashing - Narrow Mullion / 6"

	Length	Color	Order No.
	6"	White	1356008
		Terratone	1456008
		Sandtone	0608402
		Forest Green	0514129
		Canvas	9033568
		Dark Bronze	9073185
		Black	9127237



# 400 Series Arch Windows (1989 to Present)

Standard Windows

## Joining Components

Plug - Narrow Mullion / Transom End / 9/16"			
	<b>Note:</b> Use for transom joining of Flexiframe over double-hung windows. Includes left and right pair.	<b>White</b>	<b>Gray</b>
		2222051	2222053
Plug - Reinforced Mullion / Transom End / 23/32"			
	<b>Note:</b> Use for transom joining of Flexiframe over double-hung windows. Includes left and right pair.	<b>White</b>	<b>Gray</b>
		2222052	2222054

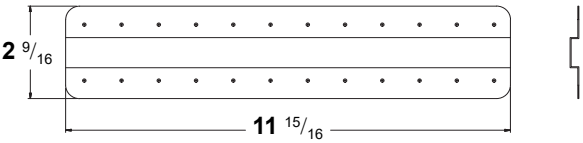
Gusset Plate - Head and Sill / Flexiframe		
		<b>Order No.</b>
		1359508

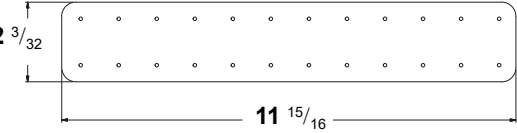
Gusset Plate - Arch & Springline		
		<b>Order No.</b>
		9142727

Gusset - Metal 12"		
		<b>Order No.</b>
		2250208

Gusset Plate - 18"		
		<b>Order No.</b>
		1600199

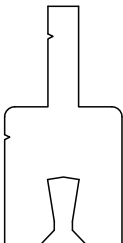
Joining Strip - Narrow Mullion (2 Piece)			
<b>Note:</b> Use the corresponding Perma-Shield Casement height for Arch windows.			
	<b>Unit No.</b>	<b>Length</b>	<b>Order No.</b>
	C3/CT/C6	36 1/16	1506424
	C45	26 17/32	1347014
	C1/C2	12 3/16	1506420
	C5	30 1/16	1347016
	CXW1/CTCXW1/C3	18 1/8	1347008
	C55	32 17/32	1347018
	CN2/C35	20 9/16	1347010
C2/CTC2/C4	24 1/8	1347012	

## Joining Components

### Support Mullion

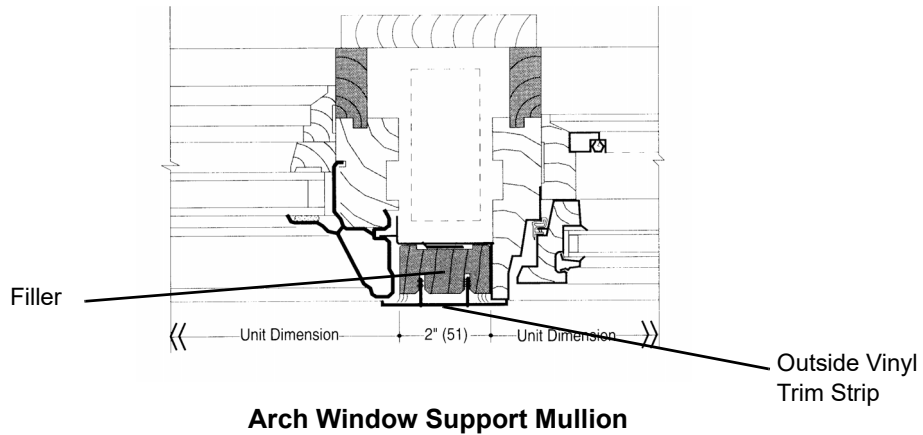

### Exterior Trim Strip - Support Mullion

	Length	Color	Order No.
	144"	White	1348620
		Terratone	1448620
		Sandtone	0611034
		Forest Green	0514106
		Canvas	9033617
		Dark Bronze	9073213
		Black	9129244

### Filler - Support Mullion

	Length	Order No.
	72"	1348812

### Exterior Flashing - Support Mullion

	Color	Order No.
	White	2222040
	Terratone	2222042
	Sandtone	2222044
	Forest Green	By description
	Canvas	9053181
	Dark Bronze	9073180
	Black	9127236

## Joining Components

### Reinforced Mull Joining Components - Steel

**Notes:**

See [Joining Guide 0005172](#)

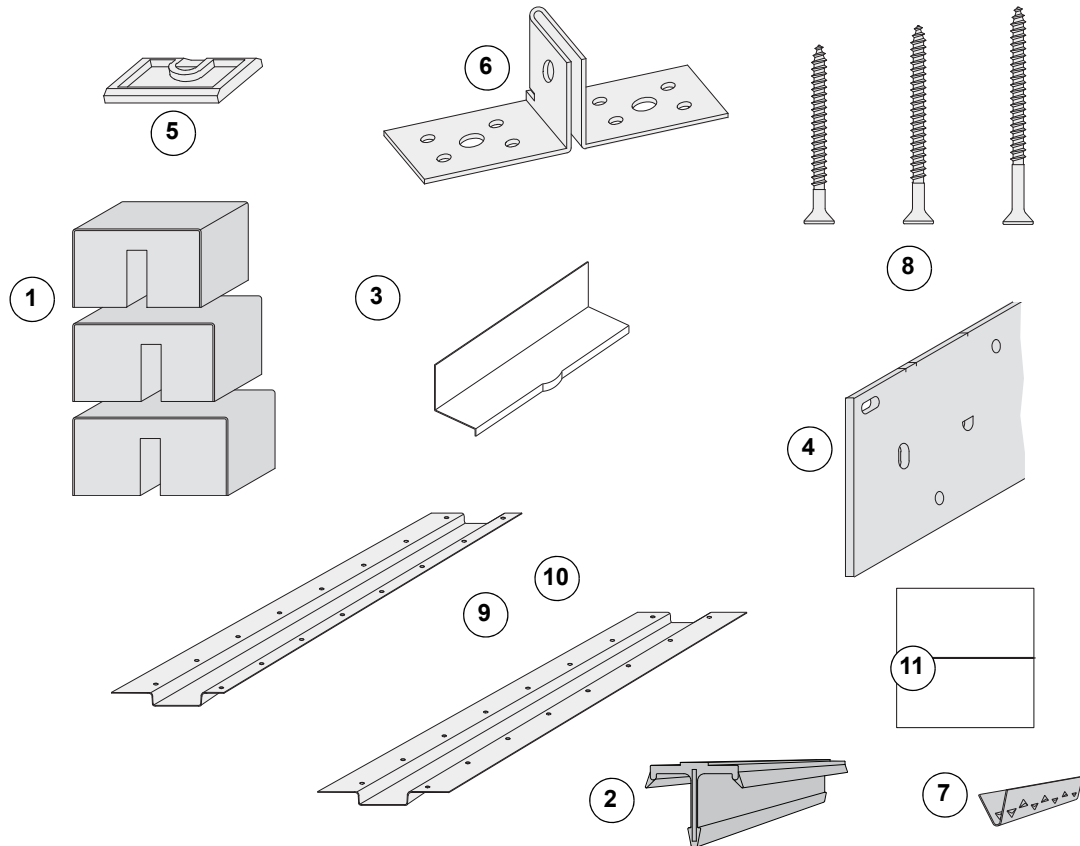

**Steel Reinforced Narrow Mullion  
for Casement, Awning, Specialty, and Circle Top™ Windows**

**IMPORTANCE OF PROPER SELECTION:**

It is essential that you select the proper joining members for Andersen windows. Andersen strongly recommends consultation with an experienced structural engineer, contractor, architect or your local Andersen window supplier prior to the installation of any Andersen product. Installation of Andersen products is the sole responsibility of the architect, building owner, contractor, and/or consumer, and Andersen has no responsibility in this regard. For more information about joining materials, please see the Andersen Residential Product Guide, the Andersen Commercial Catalog, or the Andersen Architectural Detail File.

## Joining Components

Inside Casing - Pine Ref. No. 1 <a href="#">page 43</a>					
	Species/Color	Length	2 3/8"	2 5/8"	2 15/16"
	Pine	96"	2340602	2340606	2340614
	White		2340617	2340619	2340621
	Dark Bronze		9183804	9183806	9183841
	Black		9183838	9183840	9183841
	Pine	144"	2340604	2340608	2340616
	White		2340618	2340620	2340622
	Dark Bronze		9183837	9183839	9183808
	Black		9183803	9183805	9183842

Exterior Trim Strip - Reinforced Mullion Ref. No. 2 <a href="#">page 43</a>								
	Length	White	Terra-tone®	Sandtone	Forest Green	Canvas	Dark Bronze	Black
	96"	2340504	2340508	2340512	2340528	9043184	9074013	9129253
	150"	2340502	2340506	2340510	2340526	9043183	9074012	9129252

Exterior Narrow Mull Flashing Ref. No. 3 <a href="#">page 43</a>								
	Length	White	Terra-tone®	Sandtone	Forest Green	Canvas	Dark Bronze	Black
	6"	1356008	1456008	0608402	0514129	9033568	9073185	9127237

Joining Strip - Steel Reinforced Mullion Ref. No. 4 <a href="#">page 43</a>				
			Unit Size	Order No.
			96 1/4"	2340406
			114"	2340408
			150"	2340410

End Bracket Kit - Steel Reinforced Mullion / PSC/A/CT/FF Ref. No. 5 to 8 <a href="#">page 43</a>		
	<b>Includes:</b> Instruction Sheet, Trim Strip Clips, Screw Packages RMA1, RMB1, RMC1, Location Blocks and 2 - End brackets.	<b>Order No.</b> 2340414

End Bracket - Steel Reinforced Mullion Ref. No. 6 <a href="#">page 43</a>	
	<b>Order No.</b> 2340424

# 400 Series Arch Windows (1989 to Present)

Standard Windows

## Joining Components

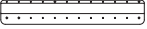
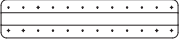
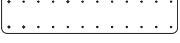
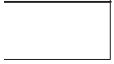
Clip - Trim Strip / Reinforced Mullion Ref. No. 7 <a href="#">page 43</a>		
		<b>Order No.</b>
		2340423
Gusset Plate Kit - Steel Reinforced Mullion / ET Ref. No. 11, 5, and 7 <a href="#">page 43</a>		
	<b>Includes:</b> Gussets, Location locks, and Screw packages: RMA-2, RMB-2, RMC-2.	<b>Order No.</b>
		2340416
Gusset Plate - Metal / PS/FF Ref. No. 9 <a href="#">page 43</a>		
		<b>Order No.</b>
		2250208
Gusset Plate - Head and Sill Ref. No. 10 <a href="#">page 43</a>		
		<b>Order No.</b>
		1359508
Gusset Plate - CTC/CTN/ET/DH		
		<b>Order No.</b>
		1359510
Flange Gasket - Mull Ref. No 11 <a href="#">page 43</a>		
	<b>Note:</b> Used over flange.	<b>Order No.</b>
		9122508

## Joining Components

### Reinforced Mull Joining Components - Aluminum

**Notes:**

See [Joining Guide 0005165](#)

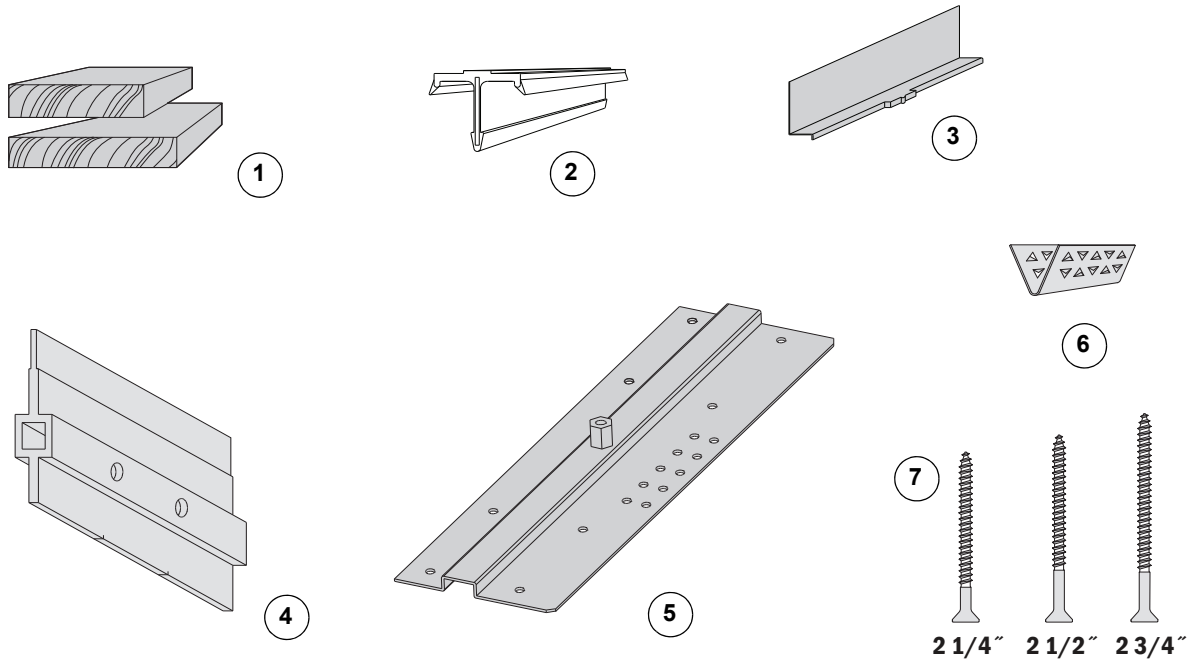

**Aluminum Reinforced Narrow Mullion  
for Casement, Awning, Specialty, and Circle Top™ Windows**

#### Inside Casing - Aluminum Reinforced Mullion Ref. No. 1

	Length	2 3/8"	2 5/8"	2 7/8"
		Casement to Casement	Casement to Flexiframe	Flexiframe to Flexiframe
	96"	1349022	1386812	1507622
	144"	1349024	1386814	1507624

#### Exterior Trim Strip - Reinforced Mullion Ref. No. 2

Unit Size	White	Terra-tone®	Sandtone	Forest Green	Canvas	Dark Bronze	Black
96"	2340504	2340508	2340512	2340528	9043184	9074013	9129252
150"	2340502	2340506	2340510	2340526	9043183	9074012	9129253

#### Exterior Flashing Ref. No. 3

Length	White	Terra-tone®	Sandtone	Forest Green	Canvas	Dark Bronze	Black
6"	1356008	1456008	0608402	0514129	9033568	9073185	9127237

# 400 Series Arch Windows (1989 to Present)

Standard Windows

## Joining Components

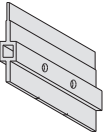
Joining Strip - Reinforced Mullion Ref. No. 4			
		Unit Size	Order No.
		72 <sup>3</sup> / <sub>32</sub> "	2340402
		92"	2340404

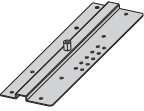
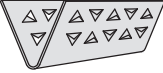
End Plate Kit - Reinforced Mullion / PSC/A/CT/FF Ref. No. 5, 6, and 7 <a href="#">page 46</a>			
	<b>Includes:</b> End plates, trim strip clip, and screws		Order No.
			2340412
End Plate - Reinforced Mullion Ref. No. 5 <a href="#">page 46</a>			
			Order No.
			2340422
Trim Clip - Reinforced Mullion Ref. No. 6 <a href="#">page 46</a>			
			Order No.
			2340423

## Art Glass Components

### Art Glass

**Note:**

Information about ordering replacement art glass panels can be found in the Andersen® Art Glass™ section of the catalog.

### Art Glass Trim Stops

#### Inside Trim Stop - Art Glass

	Unit No.	Radius	Length	Order No.
	AG AFC1	2	21 1/16"	2370218
	AG AFCW1	2	26"	2370219
	AG AFCP30	3	33 1/2"	2370220
	AG AFC2	4	46 1/4"	2370221
	AG AFCW2	5	54 3/4"	2370222
	AG AFFW50	5	57 7/8"	2370224
	AG AFFW60	6	70 7/16"	2370226
AG AFFW80	8	95 3/8"	2370228	

#### Trim Stop - Art Glass / Side

Unit No.	Description	Length	Left	Right
AG AFC06/C1/CW2	(Used on AFC106 and AFCW206)	3 1/8"	2370046	2370064
AG AFC06/CW1	(Used on AFCW106)	3 1/4"	2370048	2370066
AG AFC06/C2/CP30/FW	(Used on AFCP3006, AFC206, AFFW5006, AFFW6006, AFFW8006)	3 1/6"	2370050	2370068
AG AFC1/C1/CW2	(Used on AFC11 and AFCW21)	9 1/8"	2370052	2370070
AG AFC1/CW1	(Used on AFCW11)	9 1/4"	2370054	2370072
AG AFC1/C2/CP30/FW	(Used on AFCP301, AFC21, AFFW501, AFFW601, AFFW801)	9 1/6"	2370056	2370074
AG AFC2/C1/CW2	(Used on AFC12 and AFCW22)	21 1/4"	2370058	2370076
AG AFC2/CW1	(Used on AFCW12)	21 3/8"	2370060	2370078
AG AFC2/C2/CP30/FW	(Used on AFCP302, AFC22, AFFW502, AFFW602, AFFW802)	21 1/4"	2370062	2370080



# 400 Series Arch Windows (1989 to Present)

Standard Windows

## Art Glass Components

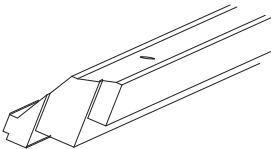
Trim Stop - Art Glass / Side				
		Unit No.	Length	Order No.
		AG PSFF68	67 1/2"	2370178
		AG PSFF611	70 7/16"	2370177
		AG PSFF80	83 9/16"	2370180

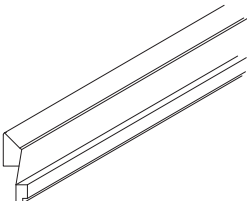
Trim Stop - Art Glass / Sill				
		Unit No.	Length	Order No.
		AG AFC1	19 7/8"	2370030
		AG AFCW1	24 1/4"	2370032
		AG AF30	31 11/16"	2370034
		AG AFC2	43 3/4"	2370036
		AG AFCW2	53 1/4"	2370038
		AG AFFW50	55"	2370040
		AG AFFW60	67"	2370042
	AG AFFW80	90 7/8"	2370044	

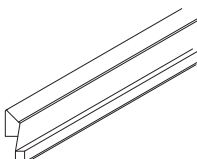
Trim Stop - Art Glass / Head and Sill				
		Unit No.	Length	Order No.
		AG FF 15"	12 5/8"	2370174
		AG FF 24"	19 3/4"	2370176

Art Glass Hardware				
Bracket Package - Top and Bottom				
	Package includes: Shims and screws			Order No.
				2370020
Bracket with Screws - Top Only				
				Order No.
				2370024
Screw Package				
		Description		Order No.
		Brass oval head / AG 1x5 STD		2370026

## Notes

---

## 400 Series Arch Windows (1989 to Present)

### Stormwatch™ Protection (Coastal Product)

**Note:**

Andersen® products with Stormwatch protection are designed for use in coastal areas. They feature design pressure upgrades, glass options, and structural enhancements. Sash are notched for grilles.

### Frame (Impact Resistant)

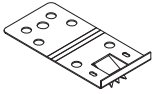
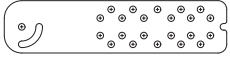
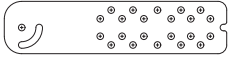
Installation Kits for Standard and Impact Resistant Units				
Jamb Clip Kit - 3"				
	<p><b>Kit includes:</b>                      (18) jamb clips                      (36) 8-18 x 1-1/4 PH FL 316 SS PASS TYP AB screws                      1 instruction sheet</p>	<p><b>Order No.</b> 1399980</p>		
Jamb Clip Kit - 6" (for units with pre-applied extension jambs)				
	<p><b>Kit includes:</b>                      Jamb clips and screws for Tilt-Wash Double-Hung Picture IR window, Casement Picture window, Flexiframe window, Arch window.</p> <p><b>Note:</b>                      For use with pre-applied extension jambs. Made of 304 annealed stainless steel, making it compatible with ACQ treated lumber. These clips are approved for use with all Stormwatch products and for Miami-Dade County. The clips are pre-punched with holes for unit installation in wall thicknesses from 4-9/16" to 7-1/8". Additional pre-punched holes are available to compensate for wall thickness variations.</p>	<p><b>Quantity</b> 18 clips</p>	<p><b>Clip Dimensions</b> 6 3/8 x 1 1/2</p>	<p><b>Order No.</b> 9014868</p>
Jamb Clips - 6" (for units with pre-applied extension jambs)				
		<p><b>Quantity</b> 500 clips</p>	<p><b>Clip Dimensions</b> 6 3/8 x 1 1/2</p>	<p><b>Order No.</b> 1376707</p>

## Notes

---

## 400 Series Arch Windows (1989 to Present)

### Service Replacement

### Service Replacement Only Parts

#### Service Replacement Only Parts

**Note:**

This section is specifically designed for parts that should only be ordered if a Territory Service Manager/Service Provider Company has requested them to be ordered or if the customer agrees to also pay for a non-warranty repair/replace service job (subject to availability) for these parts to be installed. We do not recommend anyone other than a trained AW employee or Service Provider install these parts due to the complexity of installation, modifications required for installation and/or requirement of special tools.

#### Exterior Grilles - HDN

##### Exterior Grille - HDN / Lineal / PVC

**Note:**

These grilles can only be ordered by SAR/SPC.

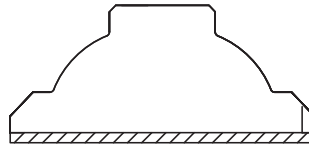

Length	White			Terratone			Sandtone		
	3/4"	7/8"	1 1/8"	3/4"	7/8"	1 1/8"	3/4"	7/8"	1 1/8"
<b>60"</b>	2322030	2322034	2322038	N/A	N/A	N/A	N/A	N/A	N/A
<b>84"</b>	2322031	2322035	2322039	N/A	N/A	N/A	N/A	N/A	N/A

## Notes

---