

What's in This Section

Note:
 Prefinished Flexiframe units were available 1980 to 1985. These units were not assembled or glazed by Andersen. Glass sizes differ from present units. Replacement parts no longer available

Standard Windows	Page 3
Parts Illustration	3
Unit Sizes	4
Standard and Custom Window Sizes	4
400 Series Product Label	4
Unit Size Chart	5
Product History	6
Product History	6
Glass	7
Glass	7
Glass Parts	8
Grilles	9
Interior Grilles	9
Interior Grilles - Octagon Windows	10
Grille Fasteners	10
Frames	11
Frame Assembly	11
Frames	11
Extension Jambs	12
Extension Jamb / Painted / Lineal Lengths	13
Thick Extension Jamb / Wood / Lineal Lengths	15
Thick Extension Jamb / Painted / Lineal Lengths	16
Stops	18
Flanges	19
Hardware	20
Locks	20
Installation Kits for Standard and Impact Resistant Units	20
Joining Components	21
Narrow Mullion	21
Support Mullion	23
Reinforced Mull Joining Components - Steel	24
Reinforced Mull Joining Components - Aluminum	27
Reinforced Mull Joining Components - LVL	29

Art Glass Components 33

 Art Glass 33

 Art Glass Trim Stops 33

 Art Glass Hardware 33

Stormwatch™ Protection (Coastal Product) Page 35

Frame (Impact Resistant) 35

 Installation Kits for Standard and Impact Resistant Units 35

Service Replacement Page 37

Service Replacement Only Parts 37

 Service Replacement Only Parts 37

 Interior Grilles - Contemporary 37

 Exterior Grilles - HDN 38

400 Series Flexiframe® Windows (1985 to Present)

Standard Windows

Parts Illustration

Parts Illustration

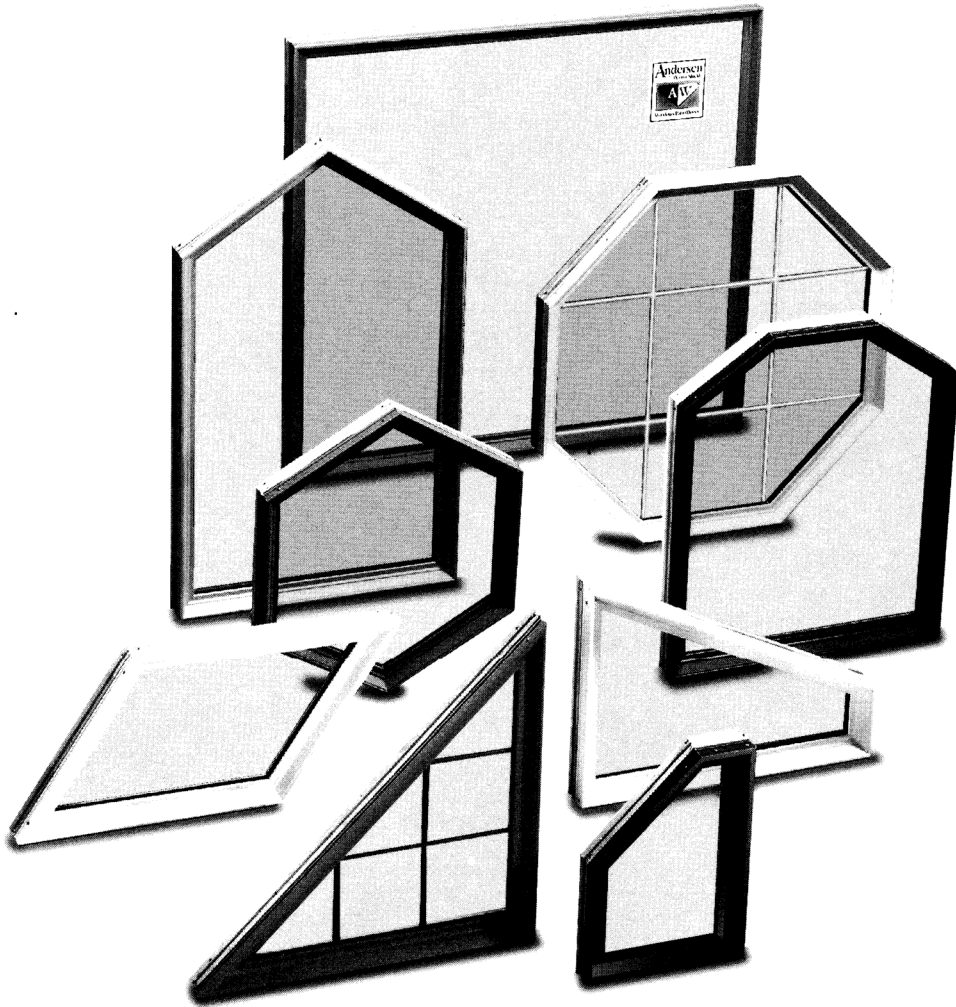

Manufactured 1986 to Present

Flexiframe® Window Parts

Unit Sizes

Standard and Custom Window Sizes

Note:

Flexiframe windows are available in standard sizes (see standard size charts, [page 5](#)). Replacement parts for some standard doors can be ordered using the numbers listed in this catalog. Many replacement parts for standard doors are made to order. These items are ordered using the Product ID found on the identification label and a description of the part needed. See [Service Guide 9051877](#).

Flexiframe windows are also available in custom sizes in 1/8" increments between the smallest and the largest standard sizes. Most replacement parts for custom-sized doors are made to order and can be ordered with the Product ID found on the identification label and a description of the part needed. See [Service Guide 9051877](#).

400 Series Product Label

Note:

Every Flexiframe window will have an identification label **or** glass etching containing a unique Product ID. The Product ID on Flexiframe windows will be located at the top of the door frame or etched into the glass. See [Service Guide 9051877](#). The Product ID may be up to 14 digits long (excluding hyphens), depending on the age of the unit. Replacement parts will also get their own unique Product ID. When ordering replacement parts, providing the Product ID ensures that replacement parts match the specifications.

Unit Size Chart

Note:

See latest [Size Chart](#). Unit Dimension refers to overall outside-to-outside frame. Octagon size grid shows additional information.

Flexiframe® Window Shapes and Design Criteria

Minimum and Maximum Limits

- Flexiframe® windows are available in many shapes and sizes with these limitations:
- Maximum standard glass area of 60 sq.ft. or 5.57 m²
 - Square footage is based on a square or rectangular shape
 - No angle may be less than 14°
 - No leg may be less than 6" (152) or greater than 144" (3658)
 - No short leg may be greater than 84" (2134)
 - See product information below for additional limitations based on specific shapes

Triangle

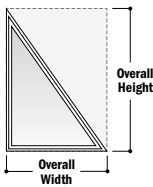

Right triangles contain one 90° corner. Specify overall width and overall height extending from the 90° corner.

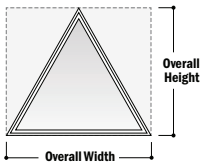

Isosceles triangles contain two sides of equal length and equal angle. Specify overall width and overall height (sill to peak).

Octagon

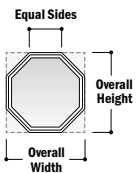

Octagons contain eight equal angles and sides. Specify length of equal side. Standard-size octagons are available in 2' (610), 2'-4" (711) and 3' (914) dimensions. See size grid.

• Dimensions in parentheses are in millimeters.

Parallelogram

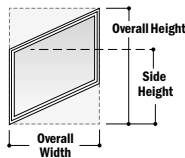

Parallelograms contain two pairs of parallel sides. Specify overall width along with side height and overall window height.

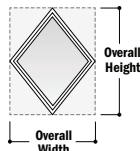

Diamonds contain two pairs of parallel and equal length sides. Specify overall width and overall height.

Hexagon

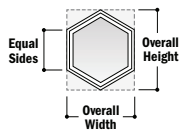

Hexagons contain six equal angles and sides. Specify length of equal side.

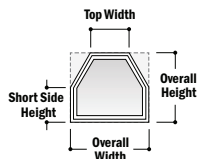

Unequal hexagons contain three pairs of angles and two sets of equal length sides. Top side is parallel to and is centered over the sill. Specify overall width, top width, short side height and overall height.

Rectangle

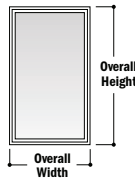
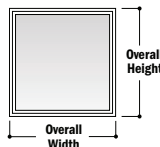

Rectangles contain four equal angles and two equal sides for rectangles or four equal sides for squares. Specify overall width and overall height.

Trapezoid

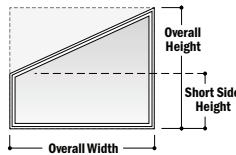
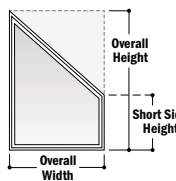

Trapezoids contain angle face cut to left or right. Specify overall width along with short side height and overall height. Window's pitch is often designed to match a roof's pitch.

Pentagon

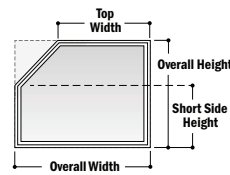

Angled pentagons contain an angle cut, or a "cut-off corner" sloping to left or right. Specify overall width and top width along with short side height and overall height.

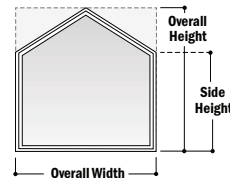

Peak pentagons contain sides of equal length, extending at right angles from the sill, and two angled sides, of equal length, that peak above center of sill. Specify overall width, side height and overall height.

Unit Dimension	2'-0" (610)	2'-4" (711)	3'-0" (914)
Rough Opening	2'-0 1/2" (622)	2'-4 1/2" (724)	3'-0 1/2" (927)
Unobstructed Glass	19 5/16" (491)	23 5/16" (592)	31 5/16" (795)



OC20



OC24



OC30

Flexiframe® Window Unit Sizes

Product History

Product History

2022	Contemporary trim stop introduced
1985	Flexiframe® Windows introduced
1980	Prefinished Flexiframe® Windows introduced

400 Series Flexiframe® Windows (1985 to Present)

Standard Windows

Glass

Glass

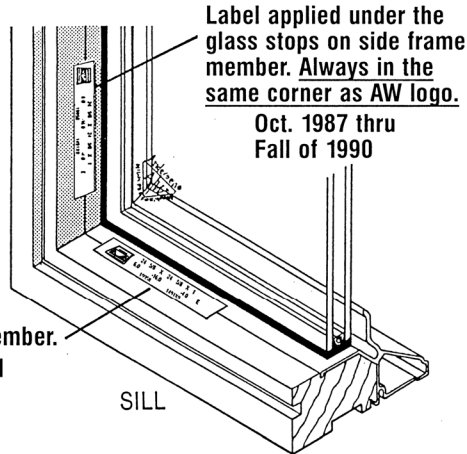

Label applied under the glass stops on side frame member. Always in the same corner as AW logo.

Oct. 1987 thru Fall of 1990

2002 to Present:
The glass logo on Flexiframe Windows has characters in a "V" configuration.



NFRC 001/002
HIGH PERFORMANCE™

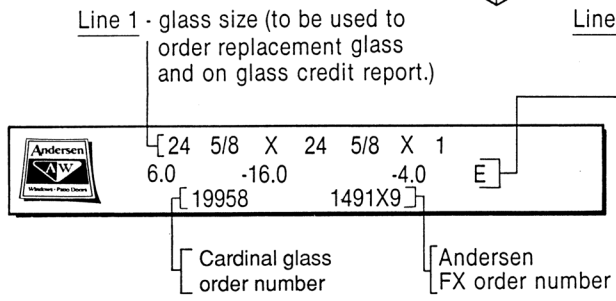

- glass nomenclature thickness, type
- 4.0 - 4mm clear
 - 4.0E - 4mm-LOE
 - 4.0BX - 4mm SUN
 - 4.0BTX - 4mm Sun-tempered
 - 6.0 - 6mm clear glass
 - 6.0E - 6mm LOE
 - 6.0BX - 6mm SUN
 - 6.0BTX - 6mm Sun-Tempered

Year	Location	Label/Logo
10/87 to 10/90	Under glass stop on side jamb	
10/90 to 12/2001	On sill frame member	
2002 to Present	Glass	<p>NFRC 001/002 HIGH PERFORMANCE™</p>

Flexiframe® Glass Dimension Label

Glass

Glass - High-Performance

Note:

Available by description. Use the glass label on the unit (see illustration above) to order.

Glass - High-Performance Sun 3

Note:

Available by description. Use the glass label on the unit (see illustration above) to order.

Glass - High-Performance Sun II

Note:

Available by description. Use the glass label on the unit (see illustration on page 7) to order.

Glass - High-Performance Tempered

Note:

Available by description. Use the glass label on the unit (see illustration on page 7) to order.

Glass - High-Performance Sun 3 Tempered

Note:

Available by description. Use the glass label on the unit (see illustration on page 7) to order.

Glass - High-Performance Sun II Tempered

Note:

Available by description.
Use the glass label on the unit (see illustration on page 7) to order.

Glass Parts

Setting Block

Note:

Available by description as glass widths can vary.
Use the glass label on the unit (see illustration on page 7) to order.
Standard size setting blocks are shown below.

	Dimensions	Order No.
	1 x 1/8 x 6	2250002
Setting Block - Head and Side		
	Dimensions	Order No.
	7/8 x 1/8 x 6	2250109
Setting Block - Spacer		
	Dimensions	Order No.
	1 x 1/4 x 6	2250106

Grilles

Interior Grilles

Note:

Grilles include fasteners. See [Accessory Guide 005285](#).

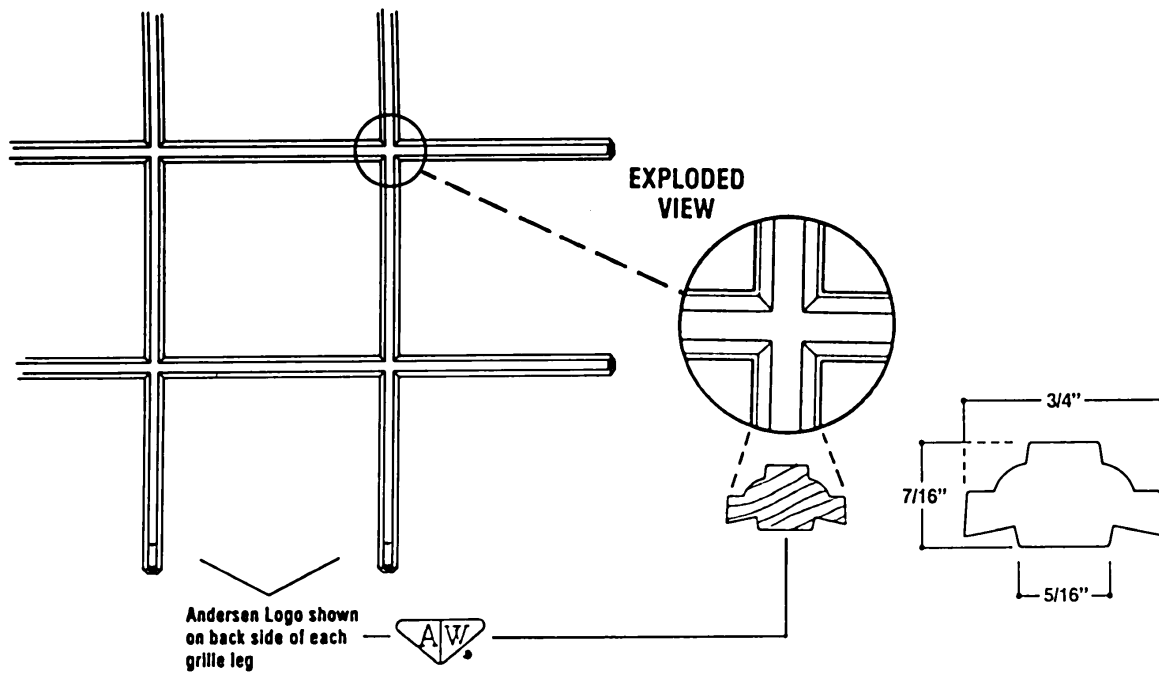

Flexiframe Window Interior Grilles

Grilles

Interior Grilles - Octagon Windows							
Interior Grille - Octagon Window / Colonial / 3/4" Wood / Natural Wood Interior							
Unit No.	Exterior						
	White	Terratone	Sandtone	Forest Green	Canvas	Dark Bronze	Black
	Maple Interior						
	 MAPLE						
OC20	2261174	2261193	2261213	2267117	By description	By description	By description
OC24	2261175	2261194	2261214	2267118	By description	By description	By description
OC30	2261176	2261195	2261215	2267119	By description	By description	By description

Interior Grille - Circle, Oval and Octagon Window / Colonial/ 3/4" Wood / Prefinished Interio							
Unit No.	Exterior						
	White	Terratone	Sandtone	Forest Green	Canvas	Dark Bronze	Black
	Interior						
	White	Terratone	Sandtone	Forest Green	Canvas	Dark Bronze	Black
OC20	2261117	2261193	2261213	2267117	By description	By description	By description
OC24	2261118	2261194	2261214	2267118	By description	By description	By description
OC30	2261119	2261195	2261215	2267119	By description	By description	By description

Grille Fasteners	
Interior Grille Fastener - Barbed	
Note: Used on products with a wood stop next to glass.	Order No. 1974314

400 Series Flexiframe® Windows (1985 to Present)

Standard Windows

Frames

Frame Assembly

Note:

See latest [Product Details](#).

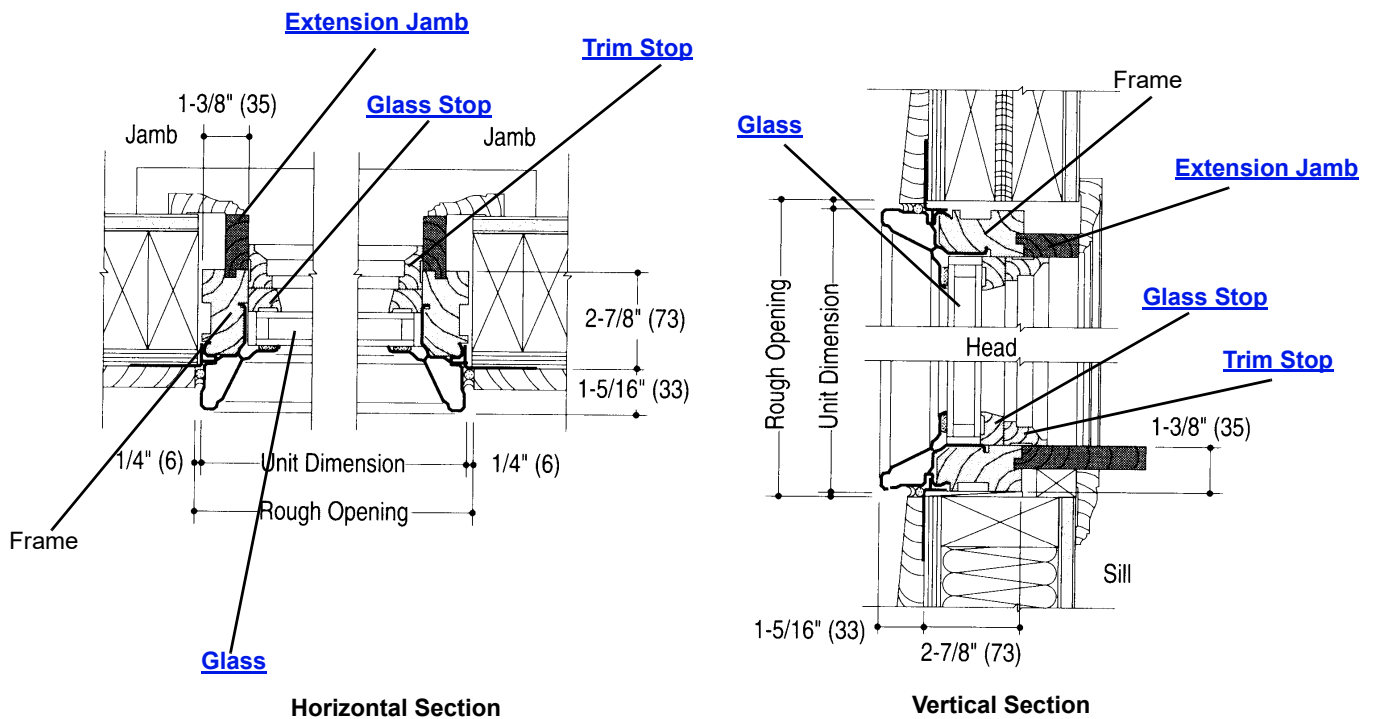

Flexiframe Frame Assembly

Frames

Frame Set / Lineal

Note:

Includes jamb and glass stop.

	Length	White	Terra-tone	Sand-tone	Forest Green	Canvas	Dark Bronze	Black
	150"	2210216	2220116	2220216	2288214	9053179	9138795	9138796

Frames

Extension Jamb

Note:

As of April 1995, 7 9/16" width was replaced with 7 1/8".

Extensions Jamb - Auxiliary/Lineal

Size	Dim B
4 9/16	1.844
5 1/4	2.531
6 9/16	3.844
7 1/8	4.406

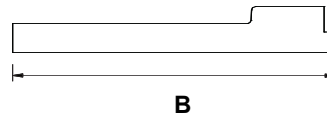

Finish	4 ft				6 ft			
	4 9/16"	5 1/4"	6 9/16"	7 1/8"	4 9/16"	5 1/4"	6 9/16"	7 1/8"
Natural Wood	1354472	1354474	1354476	1354478	1354473	1354475	1354477	1354479

Extensions Jamb - Lineal

Note:

If part is N/A use painted as a replacement.

Size	Dim B
4 9/16	1 11/16
5 1/4	2 3/8
6 9/16	3 11/16
7 1/8	4 1/4

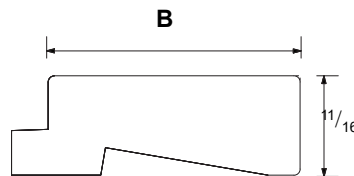

Finish	8 ft				12 ft			
	4 9/16"	5 1/4"	6 9/16"	7 1/8"	4 9/16"	5 1/4"	6 9/16"	7 1/8"
Natural Wood	1349832	1350018	1349932	1349734	1349834	1350020	1349934	1349736
White (Vinyl Wrapped)	NA	NA	NA	NA	NA	NA	NA	NA
White (Painted)	1354654	1354683	1354625	1354713	1354655	1354684	1354626	1354714
Sandtone (Painted)	9069008	9069012	9069010	9069006	9069009	9069013	9069011	9069007

400 Series Flexiframe® Windows (1985 to Present)

Standard Windows

Frames

Extension Jamb / Painted / Lineal Lengths

Extension Jamb / Painted / Lineal

Note:

Dim A does not include "tongue".

Size	Dim A
4 ⁹ / ₁₆ "	1 ¹¹ / ₁₆ "
5 ¹ / ₄ "	2 ³ / ₈ "
6 ⁹ / ₁₆ "	3 ¹¹ / ₁₆ "
7 ¹ / ₈ "	4 ¹ / ₄ "

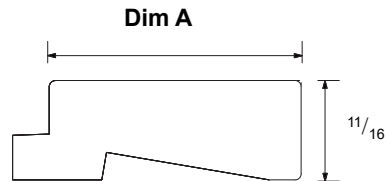

Jamb Depth	Dim A	White (Painted)		Dark Bronze Painted		Black Painted		
		96"	144"	96"	144"	96"	144"	
4"	4 ⁹ / ₁₆ "	1 ¹¹ / ₁₆ "	1354654	1354655	9146074	9146075	9146060	9146061
	4 ⁵ / ₈ "	1 ³ / ₄ "	9104056	9104052	9145304	9145303	9144706	9144705
	4 ¹¹ / ₁₆ "	1 ¹³ / ₁₆ "	9104064	9104060	9145306	9145305	9144708	9144707
	4 ³ / ₄ "	1 ⁷ / ₈ "	9104072	9104068	9145308	9145307	9144710	9144709
	4 ¹³ / ₁₆ "	1 ¹⁵ / ₁₆ "	9104080	9104076	9145310	9145309	9144712	9144711
	4 ⁷ / ₈ "	2	9104088	9104084	9145312	9145311	9144714	9144713
	4 ¹⁵ / ₁₆ "	2 ¹ / ₁₆ "	9104096	9104092	9145314	9145313	9144716	9144715
5"	5	2 ¹ / ₈ "	9104104	9104100	9145316	9145315	9144718	9144717
	5 ¹ / ₁₆ "	2 ³ / ₁₆ "	9104112	9104108	9145318	9145317	9144720	9144719
	5 ¹ / ₈ "	2 ¹ / ₄ "	9104120	9104116	9145320	9145319	9144722	9144721
	5 ³ / ₁₆ "	2 ⁵ / ₁₆ "	9104128	9104124	9145322	9145321	9144724	9144723
	5 ¹ / ₄ "	2 ³ / ₈ "	1354683	1354684	9145299	9145300	9144701	9144702
	5 ⁵ / ₁₆ "	2 ⁷ / ₁₆ "	9104136	9104132	9145324	9145323	9144726	9144725
	5 ³ / ₈ "	2 ¹ / ₂ "	9104144	9104140	9145326	9145325	9144728	9144727
	5 ⁷ / ₁₆ "	2 ⁹ / ₁₆ "	9104152	9104148	9145328	9145327	9144730	9144729
	5 ¹ / ₂ "	2 ⁵ / ₈ "	9104160	9104156	9145330	9145329	9144732	9144731
	5 ⁹ / ₁₆ "	2 ¹¹ / ₁₆ "	9104168	9104164	9145348	9145331	9144734	9144733
	5 ⁵ / ₈ "	2 ³ / ₄ "	9104176	9104172	9145334	9145333	9144736	9144735
	5 ¹¹ / ₁₆ "	2 ¹³ / ₁₆ "	9104184	9104180	9145336	9145335	9144738	9144737
	5 ³ / ₄ "	2 ⁷ / ₈ "	9104192	9104188	9145338	9145337	9144740	9144739
	5 ¹³ / ₁₆ "	2 ¹⁵ / ₁₆ "	9104200	9104196	9145340	9145339	9144742	9144741
5 ⁷ / ₈ "	3	9104208	9104204	9145342	9145341	9144744	9144743	
5 ¹⁵ / ₁₆ "	3 ¹ / ₁₆ "	9104216	9104212	9145344	9145343	9144746	9144745	
6"	6	3 ¹ / ₈ "	9104224	9104220	9145346	9145345	9144748	9144747
	6 ¹ / ₁₆ "	3 ³ / ₁₆ "	9104232	9104228	9145348	9145347	9144750	9144749
	6 ¹ / ₈ "	3 ¹ / ₄ "	9104240	9104236	9145350	9145349	9144752	9144751
	6 ³ / ₁₆ "	3 ⁵ / ₁₆ "	9104248	9104244	9145352	9145351	9144754	9144753
	6 ¹ / ₄ "	3 ³ / ₈ "	9104256	9104252	9145354	9145353	9144756	9144755
	6 ⁵ / ₁₆ "	3 ⁷ / ₁₆ "	9104264	9104260	9145356	9145355	9144758	9144757
	6 ³ / ₈ "	3 ¹ / ₂ "	9104272	9104268	9145358	9145357	9144760	9144759
	6 ⁷ / ₁₆ "	3 ⁹ / ₁₆ "	9104280	9104276	9145360	9145359	9144762	9144761
	6 ¹ / ₂ "	3 ⁵ / ₈ "	9104288	9104284	9145362	9145361	9144764	9144763
	6 ⁹ / ₁₆ "	3 ¹¹ / ₁₆ "	1354625	1354626	9146072	9146073	9146058	9146059
	6 ⁵ / ₈ "	3 ³ / ₄ "	9104296	9104292	9145364	9145363	9144766	9144765
	6 ¹¹ / ₁₆ "	3 ¹³ / ₁₆ "	9104304	9104300	9145366	9145365	9144768	9144767
	6 ³ / ₄ "	3 ⁷ / ₈ "	9104312	9104308	9145368	9145367	9144770	9144769
	6 ¹³ / ₁₆ "	3 ¹⁵ / ₁₆ "	9104320	9104316	9145370	9145369	9144772	9144771
	6 ⁷ / ₈ "	4	9104328	9104324	9145372	9145371	9144774	9144773
	6 ¹⁵ / ₁₆ "	4 ¹ / ₁₆ "	9104336	9104332	9145374	9145373	9144776	9144775

Frames

Extension Jamb / Painted / Lineal Lengths

Extension Jamb / Painted / Lineal

Note:

Dim A does not include "tongue".

Size	Dim A
4 ⁹ / ₁₆ "	1 ¹¹ / ₁₆
5 ¹ / ₄ "	2 ³ / ₈
6 ⁹ / ₁₆ "	3 ¹¹ / ₁₆
7 ¹ / ₈ "	4 ¹ / ₄

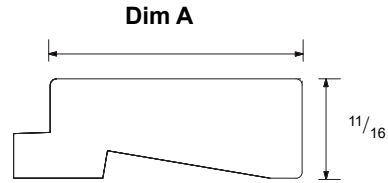

Jamb Depth	Dim A	White (Painted)		Dark Bronze Painted		Black Painted		
		96"	144"	96"	144"	96"	144"	
7"	7	4 ¹ / ₈	9104344	9104340	9145376	9145375	9144778	9144777
	7 ¹ / ₁₆	4 ³ / ₁₆	9104352	9104348	9145378	9145377	9144780	9144779
	7 ¹ / ₈	4 ¹ / ₄	1354713	1354714	9145301	9145302	9144703	9144704
	7 ³ / ₁₆	4 ⁵ / ₁₆	9205051	9205231	9205081	9205261	9205111	9205338
	7 ¹ / ₄	4 ³ / ₈	9205052	9205232	9205082	9205262	9205112	9205339
	7 ⁵ / ₁₆	4 ⁷ / ₁₆	9205053	9205233	9205083	9205263	9205113	9205340
	7 ³ / ₈	4 ¹ / ₂	9205054	9205234	9205084	9205264	9205114	9205341
	7 ⁷ / ₁₆	4 ⁹ / ₁₆	9205055	9205235	9205085	9205265	9205115	9205342
	7 ¹ / ₂	4 ⁵ / ₈	9205056	9205236	9205086	9205266	9205116	9205343
	7 ⁹ / ₁₆	4 ¹¹ / ₁₆	9205057	9205237	9205087	9205267	9205117	9205344
	7 ⁵ / ₈	4 ³ / ₄	9205058	9205238	9205088	9205268	9205118	9205345
	7 ¹¹ / ₁₆	4 ¹³ / ₁₆	9205059	9205239	9205089	9205269	9205119	9205346
	7 ³ / ₄	4 ⁷ / ₈	9205060	9205240	9205090	9205270	9205120	9205347
	7 ¹³ / ₁₆	4 ¹⁵ / ₁₆	9205061	9205241	9205091	9205271	9205121	9205348
7 ⁷ / ₈	5	9205062	9205242	9205092	9205272	9205122	9205349	
8"	7 ¹⁵ / ₁₆	5 ¹ / ₁₆	9205063	9205243	9205093	9205273	9205123	9205350
	8	5 ¹ / ₈	9205064	9205244	9205094	9205274	9205124	9205351
	8 ¹ / ₁₆	5 ³ / ₁₆	9205065	9205245	9205095	9205275	9205125	9205352
	8 ¹ / ₈	5 ¹ / ₄	9205066	9205246	9205096	9205276	9205126	9205353
	8 ³ / ₁₆	5 ⁵ / ₁₆	9205067	9205247	9205097	9205277	9205127	9205354
	8 ¹ / ₄	5 ³ / ₈	9205068	9205248	9205098	9205278	9205128	9205355
	8 ⁵ / ₁₆	5 ⁷ / ₁₆	9205069	9205249	9205099	9205279	9205129	9205356
	8 ³ / ₈	5 ¹ / ₂	9205070	9205250	9205100	9205280	9205130	9205357
	8 ⁷ / ₁₆	5 ⁹ / ₁₆	9205071	9205251	9205101	9205281	9205131	9205358
	8 ¹ / ₂	5 ⁵ / ₈	9205072	9205252	9205102	9205282	9205132	9205359
	8 ⁹ / ₁₆	5 ¹¹ / ₁₆	9205073	9205253	9205103	9205283	9205133	9205360
	8 ⁵ / ₈	5 ³ / ₄	9205074	9205254	9205104	9205284	9205134	9205361
	8 ¹¹ / ₁₆	5 ¹³ / ₁₆	9205075	9205255	9205105	9205332	9205135	9205362
	8 ³ / ₄	5 ⁷ / ₈	9205076	9205256	9205106	9205333	9205136	9205363
8 ¹³ / ₁₆	5 ¹⁵ / ₁₆	9205077	9205257	9205107	9205334	9205137	9205364	
8 ⁷ / ₈	6	9205078	9205258	9205108	9205335	9205138	9205365	
9"	8 ¹⁵ / ₁₆	6 ¹ / ₁₆	9205079	9205259	9205109	9205336	9205139	9205366
	9	6 ¹ / ₈	9205080	9205260	9205110	9205337	9205140	9205367

400 Series Flexiframe® Windows (1985 to Present)

Standard Windows

Thick Extension Jamb / Wood / Lineal Lengths

Thick Extension Jamb / Wood / Lineal

Note:

Dim A does not include “tongue”.

Size	Dim A
4 9/16"	1 47/64
5 1/4"	2 25/64
6 9/16"	3 47/64
7 1/8"	4 17/64

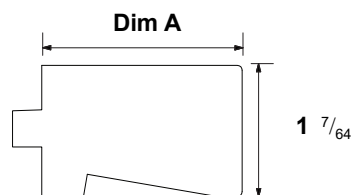

Jamb Depth	Dim A	Pine		Oak		Maple		
		96"	144"	96"	144"	96"	144"	
4"	4 9/16	1 11/16	9040777	9040782	9040780	9040785	9040781	9040786
	4 5/8	1 3/4	9117601	9117602	9117605	9117606	9117607	9117608
	4 11/16	1 13/16	9117609	9117610	9117613	9117614	9117615	9117616
	4 3/4	1 7/8	9117617	9117618	9117621	9117622	9117623	9117624
	4 13/16	1 15/16	9117625	9117626	9117629	9117630	9117631	9117632
	4 7/8	2	9117633	9117634	9117637	9117638	9117639	9117640
	4 15/16	2 1/16	9117641	9117642	9117645	9117646	9117647	9117648
5"	5	2 1/8	9117649	9117650	9117653	9117654	9117655	9117656
	5 1/16	2 3/16	9117657	9117658	9117661	9117662	9117663	9117664
	5 1/8	2 1/4	9117665	9117666	9117669	9117670	9117671	9117672
	5 3/16	2 5/16	9117673	9117674	9117677	9117678	9117679	9117680
	5 1/4	2 3/8	9040787	9040792	9040790	9040795	9040791	9040796
	5 5/16	2 7/16	9117681	9117682	9117685	9117686	9117687	9117688
	5 3/8	2 1/2	9117689	9117690	9117693	9117694	9117695	9117696
	5 7/16	2 9/16	9117697	9117698	9117701	9117702	9117703	9117704
	5 1/2	2 5/8	9117705	9117706	9117709	9117710	9117711	9117712
	5 9/16	2 11/16	9117713	9117714	9117717	9117718	9117719	9117720
	5 5/8	2 3/4	9117721	9117722	9117725	9117726	9117727	9117728
	5 11/16	2 13/16	9117729	9117730	9117733	9117734	9117735	9117736
	5 3/4	2 7/8	9117737	9117738	9117741	9117742	9117743	9117744
	5 13/16	2 15/16	9117745	9117746	9117749	9117750	9117751	9117752
	5 7/8	3	9117753	9117754	9117757	9117758	9117759	9117760
5 15/16	3 1/16	9117761	9117762	9117765	9117766	9117767	9117768	
6"	6	3 1/8	9117769	9117770	9117773	9117774	9117775	9117776
	6 1/16	3 3/16	9117777	9117778	9117781	9117782	9117783	9117784
	6 1/8	3 1/4	9117785	9117786	9117789	9117790	9117791	9117792
	6 3/16	3 5/16	9117793	9117794	9117797	9117798	9117799	9117800
	6 1/4	3 3/8	9117801	9117802	9117805	9117806	9117807	9117808
	6 5/16	3 7/16	9117809	9117810	9117813	9117814	9117815	9117816
	6 3/8	3 1/2	9117817	9117818	9117821	9117822	9117823	9117824
	6 7/16	3 9/16	9117825	9117826	9117829	9117830	9117831	9117832
	6 1/2	3 5/8	9117833	9117834	9117837	9117838	9117839	9117840
	6 9/16	3 11/16	9040767	9040772	9040770	9040775	9040771	9040776
	6 5/8	3 3/4	9117841	9117842	9117845	9117846	9117847	9117848
	6 11/16	3 13/16	9117849	9117850	9117853	9117854	9117855	9117856
	6 3/4	3 7/8	9117857	9117858	9117861	9117862	9117863	9117864
	6 13/16	3 15/16	9117865	9117866	9117869	9117870	9117871	9117872
	6 7/8	4	9117873	9117874	9117877	9117878	9117879	9117880
6 15/16	4 1/16	9117881	9117882	9117885	9117886	9117887	9117888	
7"	7	4 1/8	9117889	9117890	9117893	9117894	9117895	9117896
	7 1/16	4 3/16	9117897	9117898	9117901	9117902	9117903	9117904
	7 1/8	4 1/4	9040797	9040802	9040800	9040805	9040801	9040806

Thick Extension Jamb / Painted / Lineal Lengths

Thick Extension Jamb / Painted / Lineal

Note:
Dim A does not include "tongue".

Size	Dim A
4 9/16"	1 47/64
5 1/4"	2 25/64
6 9/16"	3 47/64
7 1/8"	4 17/64

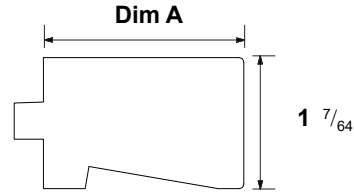

Jamb Depth	Dim A	White (Painted)		Dark Bronze Painted		Black Painted		
		96"	144"	96"	144"	96"	144"	
4"	4 9/16	1 11/16	9040778	9040783	9146084	9146085	9146070	9146071
	4 5/8	1 3/4	9117603	9117604	9145821	9145822	9145223	9145224
	4 11/16	1 13/16	9117611	9117612	9145823	9145824	9145225	9145226
	4 3/4	1 7/8	9117619	9117620	9145825	9145826	9145227	9145228
	4 13/16	1 15/16	9117627	9117628	9145827	9145828	9145229	9145230
	4 7/8	2	9117635	9117636	9145829	9145830	9145231	9145232
	4 15/16	2 1/16	9117643	9117644	9145831	9145832	9145233	9145234
5"	5	2 1/8	9117651	9117652	9145833	9145834	9145235	9145236
	5 1/16	2 3/16	9117659	9117660	9145835	9145836	9145237	9145238
	5 1/8	2 1/4	9117667	9117668	9145837	9145838	9145239	9145240
	5 3/16	2 5/16	9117675	9117676	9145839	9145840	9145241	9145242
	5 1/4	2 3/8	9040788	9040793	9145817	9145818	9145219	9145220
	5 5/16	2 7/16	9117683	9117684	9145841	9145842	9145243	9145244
	5 3/8	2 1/2	9117691	9117692	9145843	9145844	9145245	9145246
	5 7/16	2 9/16	9117699	9117700	9145845	9145846	9145247	9145248
	5 1/2	2 5/8	9117707	9117708	9145847	9145848	9145249	9145250
	5 9/16	2 11/16	9117715	9117716	9145849	9145850	9145251	9145252
	5 5/8	2 3/4	9117723	9117724	9145851	9145852	9145253	9145254
	5 11/16	2 13/16	9117731	9117732	9145853	9145854	9145255	9145256
	5 3/4	2 7/8	9117739	9117740	9145855	9145856	9145257	9145258
	5 13/16	2 15/16	9117747	9117748	9145857	9145858	9145259	9145260
	5 7/8	3	9117755	9117756	9145859	9145860	9145261	9145262
5 15/16	3 1/16	9117763	9117764	9145861	9145862	9145263	9145264	
6"	6	3 1/8	9117771	9117772	9145863	9145864	9145265	9145266
	6 1/16	3 3/16	9117779	9117780	9145865	9145866	9145267	9145268
	6 1/8	3 1/4	9117787	9117788	9145867	9145868	9145269	9145270
	6 3/16	3 5/16	9117795	9117796	9145869	9145870	9145271	9145272
	6 1/4	3 3/8	9117803	9117804	9145871	9145872	9145273	9145274
	6 5/16	3 7/16	9117811	9117812	9145873	9145874	9145275	9145276
	6 3/8	3 1/2	9117819	9117820	9145875	9145876	9145277	9145278
	6 7/16	3 9/16	9117827	9117828	9145877	9145878	9145279	9145280
	6 1/2	3 5/8	9117835	9117836	9145879	9145880	9145281	9145282
	6 9/16	3 11/16	9040768	9040773	9146082	9146083	9146068	9146069
	6 5/8	3 3/4	9117843	9117844	9145881	9145882	9145283	9145284
	6 11/16	3 13/16	9117851	9117852	9145883	9145884	9145285	9145286
	6 3/4	3 7/8	9117859	9117860	9145885	9145886	9145287	9146069
	6 13/16	3 15/16	9117867	9117868	9145887	9145888	9145289	9145290
	6 7/8	4	9117875	9117876	9145889	9145890	9145291	9145292
6 15/16	4 1/16	9117883	9117884	9145891	9145892	9145293	9145294	
7"	7	4 1/8	9117891	9117892	9145893	9145894	9145295	9145296
	7 1/16	4 3/16	9117899	9117900	9145895	9145896	9145297	9145298
	7 1/8	4 1/4	9040798	9040803	9145819	9145820	9145221	9145222

400 Series Flexiframe® Windows (1985 to Present)

Standard Windows

Frames

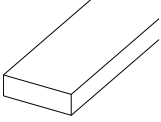
Trim - Mull Alignment							
	Note: Use mull alignment trim with extension jambs when mulling Casement windows to Flexiframe windows.	Qty	Size	Natural Wood	White	Dark Bronze	Black
		1	$1/4 \times 7/8 \times 48$	1348721	9055409		
		20	$9/32 \times 1 \ 7/64 \times 96$	2340623	2340625		
		20	$9/32 \times 1 \ 7/64 \times 144$	2340624	2340626		

Frames

Stops

Trim Stop - Traditional

	Length	Pine	White	Terratone	Sandtone	Forest Green	Canvas	Prairie Grass
	22	2230087	2233055	9185203	9185189	9185259	9185245	9185287
	46	2230088	2233056	9185204	9185190	9185260	9185246	9185288
	70	2230089	2233057	9185205	9185191	9185261	9185247	9185289
	80	2230093	9055292	9185208	9185194	9185264	9185250	9185292
	94	2230090	2233058	9185206	9185192	9185262	9185248	9185290
	142	2230091	2233059	9185207	9185193	9185263	9185249	9185291
	Length	Cocoa Bean	Dove Gray	Red Rock	Dark Bronze	Black		
	22	9185315	9185273	9185301	9185231	9185217		
	46	9185316	9185274	9185302	9185232	9185218		
	70	9185317	9185275	9185303	9185233	9185219		
	80	9185320	9185278	9185306	9185236	9185222		
	94	9185318	9185276	9185304	9185234	9185220		
142		9185277	9185305	9185235	9185221			

Trim Stop - Contemporary (February 2022 to Present)

	Length	Pine	White	Terratone	Sandtone	Forest Green	Canvas	Prairie Grass
	22	9190860	9190866	9190902	9190888	9190958	9190944	9190986
	46	9190861	9190867	9190903	9190889	9190959	9190945	9190987
	70	9190862	9190868	9190904	9190890	9190960	9190946	9190988
	80	9190865	9190879	9190907	9190893	9190963	9190949	9190991
	94	9190863	9190869	9190905	9190891	9190961	9190947	9190989
	142	9190864	9190870	9190906	9190892	9190962	9190948	9190990
	Length	Cocoa Bean	Dove Gray	Red Rock	Dark Bronze	Black		
	22	9191014	9190972	9191000	9190930	9190916		
	46	9191015	9190973	9191001	9190931	9190917		
	70	9191016	9190974	9191002	9190932	9190918		
	80	9191019	9190977	9191005	9190935	9190921		
	94	9191017	9190975	9191003	9190933	9190919		
142	9191018	9190976	9191004	9190934	9190920			

400 Series Flexiframe® Windows (1985 to Present)

Standard Windows

Frames

Glass Stop - Lineal									
	Length	Pine	White	Terratone	Sandtone	Forest Green	Canvas	Prairie Grass	
	22	2230082	2233050	9185055	9185041	9185111	9185097	9185139	
	46	2230083	2233051	9185056	9185042	9185112	9185098	9185140	
	70	2230084	2233052	9185057	9185043	9185113	9185099	9185141	
	80	2230092	9055293	9185060	9185046	9185116	9185102	9185144	
	94	2230085	2233053	9185058	9185044	9185114	9185100	9185142	
	142	2230086	2233054	9185059	9185045	9185115	9185101	9185143	
	Length	Cocoa Bean	Dove Gray	Red Rock	Dark Bronze	Black			
	22	9185167	9185125	9185153	9185083	9185069			
	46	9185168	9185126	9185154	9185084	9185070			
	70	9185169	9185127	9185155	9185085	9185071			
	80	9185172	9185130	9185158	9185088	9185074			
	94	9185170	9185128	9185156	9185086	9185072			
	142	9185171	9185129	9185157	9185087	9185073			

Flanges		
Flange - Arch / Nailing		
	Length	Order No.
	156"	8240605
Flange - Installation		
	Length	Order No.
	74"	8240606
	150"	8240607

Hardware

Hardware

Locks	
Lock with Screws - Two-Piece Adjusting Corner	
	Order No. 2230010
Lock with Screws - 90° Corner	
	Order No. 2230004
Screw - Corner Lock	
	Order No. 2260202

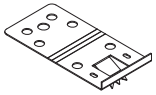
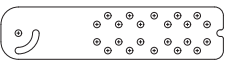
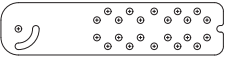
Installation Kits for Standard and Impact Resistant Units				
Jamb Clip Kit - 3"				
	Kit includes: 18 - jamb clips 36 - 8-18 x 1-1/4 PH FL 316 SS PASS TYP AB screws 1 instruction sheet	Order No.		
		1399980		
Jamb Clip Kit - 6" (for units with pre-applied extension jambs)				
	Kit includes: Jamb clips and screws for Tilt-Wash Double-Hung Picture IR window, Casement Picture window, Flexiframe window, Arch window. Note: For use with pre-applied extension jambs. Made of 304 annealed stainless steel, making it compatible with ACQ treated lumber. These clips are approved for use with all Stormwatch products and for Miami-Dade County. The clips are pre-punched with holes for unit installation in wall thicknesses from 4-9/16" to 7-1/8". Additional pre-punched holes are available to compensate for wall thickness variations.	Quantity	Clip Dimensions	Order No.
		18 clips	6 3/8 x 1 1/2	9014868
Jamb Clips - 6" (for units with pre-applied extension jambs)				
		Quantity	Clip Dimensions	Order No.
		500 clips	6 3/8 x 1 1/2	1376707

400 Series Flexiframe® Windows (1985 to Present)

Standard Windows

Joining Components

Joining Components

Narrow Mullion

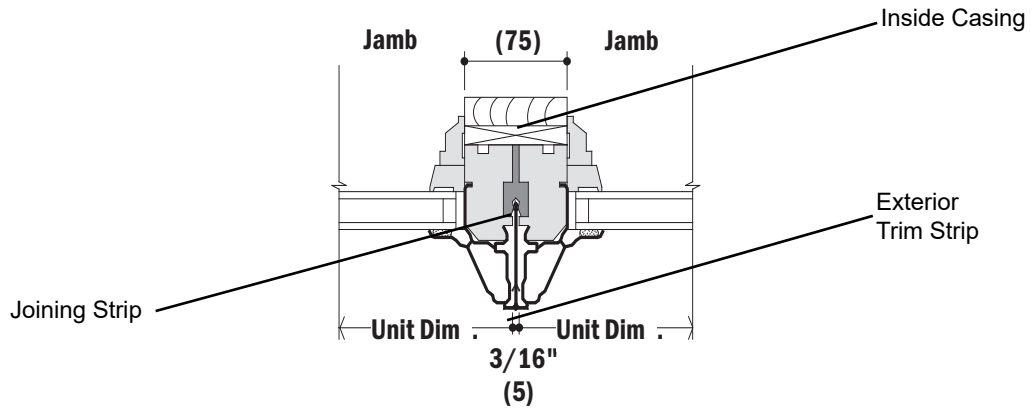

Flexiframe Narrow Mullion

Exterior Trim Strip - Narrow Mullion

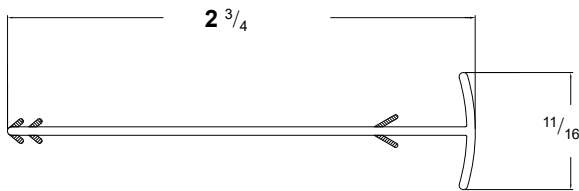

Length

144"

Color

White	1348520
Terratone	1448520
Sandtone	0607234
Forest Green	0514105
Canvas	9033596
Dark Bronze	By description
Black	9129227

Order No.

Inside Casing - Mullion

Length

2 3/8"

2 5/8"

2 7/8"

Notes: See [Andesen Casing Applications 0005318](#)

96"

1349022

1386812

1507622

144"

1349024

1386814

1507624

Exterior Flashing - Narrow Mullion

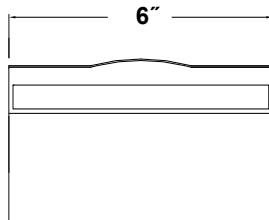

Length

6"

Color

White	1356008
Terratone	1456008
Sandtone	0608402
Forest Green	0514129
Canvas	9033568
Dark Bronze	9073185
Black	9127235

Order No.

Gusset Plate - Head and Sill / Flexiframe

Joining Components

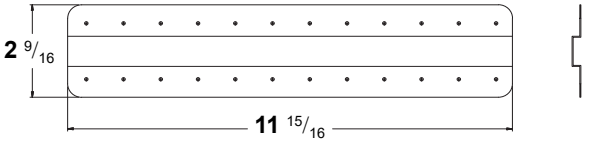
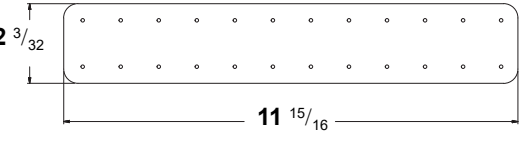
		Order No.
		1359508
Gusset Plate - Arch & Springline		
		Order No.
		9142727
Gusset - Metal 12"		
		Order No.
		2250208
Gusset Plate - 18"		
		Order No.
		1600199

Joining Strip		
	Length	Order No.
	94"	9043307

400 Series Flexiframe® Windows (1985 to Present)

Standard Windows

Joining Components

Support Mullion

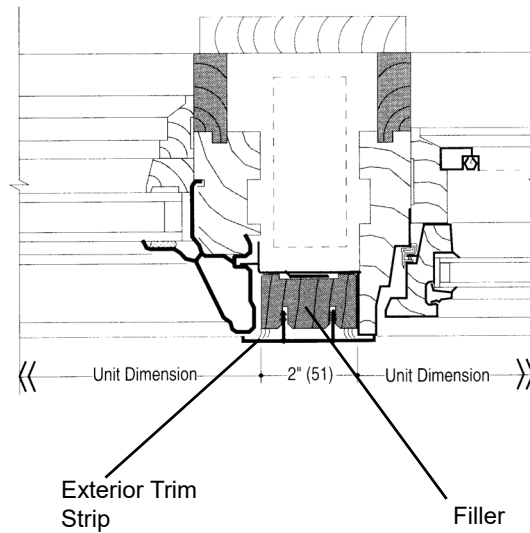

Flexiframe Support Mullion

Exterior Trim Strip - Support Mullion								
	Length	White	Terra-tone	Sand-tone	Forest Green	Canvas	Dark Bronze	Black
	144"	1348620	1448620	0611034	0514106	9033617	9073213	9129244
Exterior Flashing - Support Mullion								
	Length	White	Terra-tone	Sand-tone	Forest Green	Canvas	Dark Bronze	Black
	8"	2222040	2222042	2222044	OBD	9053181	9073180	9127236
	6"	1356012	1456012	0608404	0514130	9033569	9073186	9127238
Filler - Support Mullion								
							Length	Order No.
							72"	1348812

Joining Components

Reinforced Mull Joining Components - Steel

Notes:

See [Joining Guide 0005172](#)

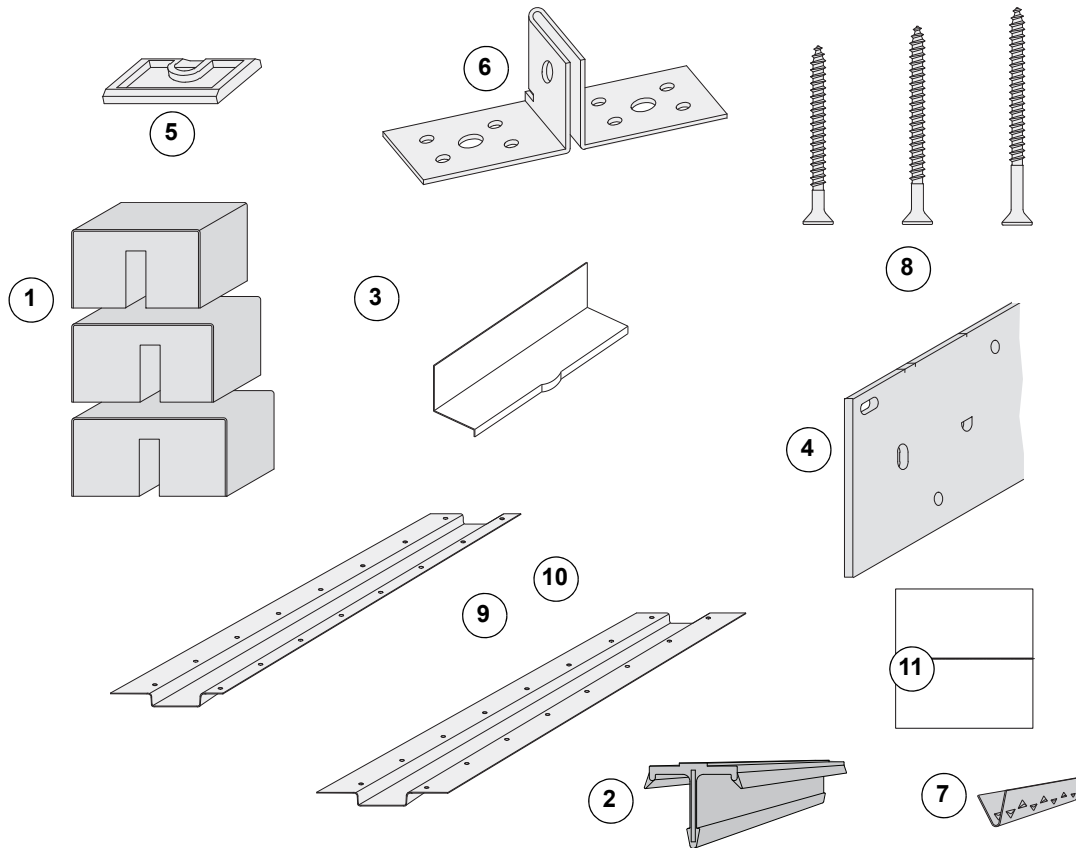

**Steel Reinforced Narrow Mullion
for Casement, Awning, Specialty, and Circle Top™ Windows**

IMPORTANCE OF PROPER SELECTION:

It is essential that you select the proper joining members for Andersen windows. Andersen strongly recommends consultation with an experienced structural engineer, contractor, architect or your local Andersen window supplier prior to the installation of any Andersen product. Installation of Andersen products is the sole responsibility of the architect, building owner, contractor, and/or consumer, and Andersen has no responsibility in this regard. For more information about joining materials, please see the Andersen Residential Product Guide, the Andersen Commercial Catalog, or the Andersen Architectural Detail File.

400 Series Flexiframe® Windows (1985 to Present)

Standard Windows

Joining Components

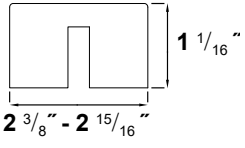
Inside Casing - Pine Ref. No. 1 page 24					
	Species/Color	When used Length	Csmt to Csmt 2 3/8"	Csmt to Flexi 2 5/8"	Flexi to Flexi 2 15/16"
	Pine	96"	2340602	2340606	2340614
	White		2340617	2340619	2340621
	Dark Bronze		9183804	9183806	9183841
	Black		9183838	9183840	9183807
	Pine	144"	2340604	2340608	2340616
	White		2340618	2340620	2340622
	Dark Bronze		9183837	9183839	9183808
	Black		9183803	9183805	9183842

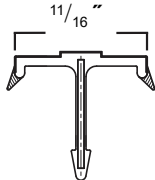
Exterior Trim Strip - Reinforced Mullion Ref. No. 2 page 24								
	Length	White	Terratone	Sandtone	Forest Green	Canvas	Dark Bronze	Black
	96"	2340504	2340508	2340512	2340528	9043184	9074013	9129253
	150"	2340502	2340506	2340510	2340526	9043183	9074012	9129252

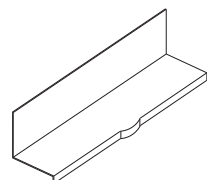

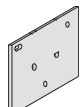

Exterior Narrow Mull Flashing Ref. No. 3 page 24								
	Length	White	Terratone	Sandtone	Forest Green	Canvas	Dark Bronze	Black
	6"	1356008	1456008	0608402	0514129	9033568	9073185	9127237

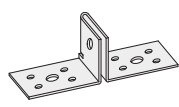
Joining Strip - Steel Reinforced Mullion Ref. No. 4 page 24						
				Unit Size	Order No.	
					96 1/4"	2340406
					114"	2340408
					150"	2340410

End Bracket Kit - Steel Reinforced Mullion / PSC/A/CT/FF Ref. No. 5 to 8 page 24		
	Includes: Instruction Sheet, Trim Strip Clips, Screw Packages RMA1, RMB1, RMC1, Location Blocks and 2 - End brackets.	Order No. 2340414

End Bracket - Steel Reinforced Mullion Ref. No. 6 page 24	
	Order No. 2340424

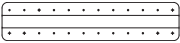
Joining Components

Clip - Trim Strip / Reinforced Mullion Ref. No. 7 page 24		
		Order No.
		2340423
Gusset Plate Kit - Steel Reinforced Mullion / ET Ref. No. 11, 5, and 7 page 24		
	Includes: Gussets, Location locks, and Screw packages: RMA-2, RMB-2, RMC-2.	Order No.
		2340416
Gusset Plate - Metal / PS/FF Ref. No. 9 page 24		
		Order No.
		2250208
Gusset Plate - Head and Sill Ref. No. 10 page 24		
		Order No.
		1359508
Gusset Plate - CTC/CTN/ET/DH		
		Order No.
		1359510
Flange Gasket - Mull Ref. No 11 page 24		
	Note: Used over flange.	Order No.
		9122508

400 Series Flexiframe® Windows (1985 to Present)

Standard Windows

Joining Components

Reinforced Mull Joining Components - Aluminum

Notes:

See [Joining Guide 0005165](#)

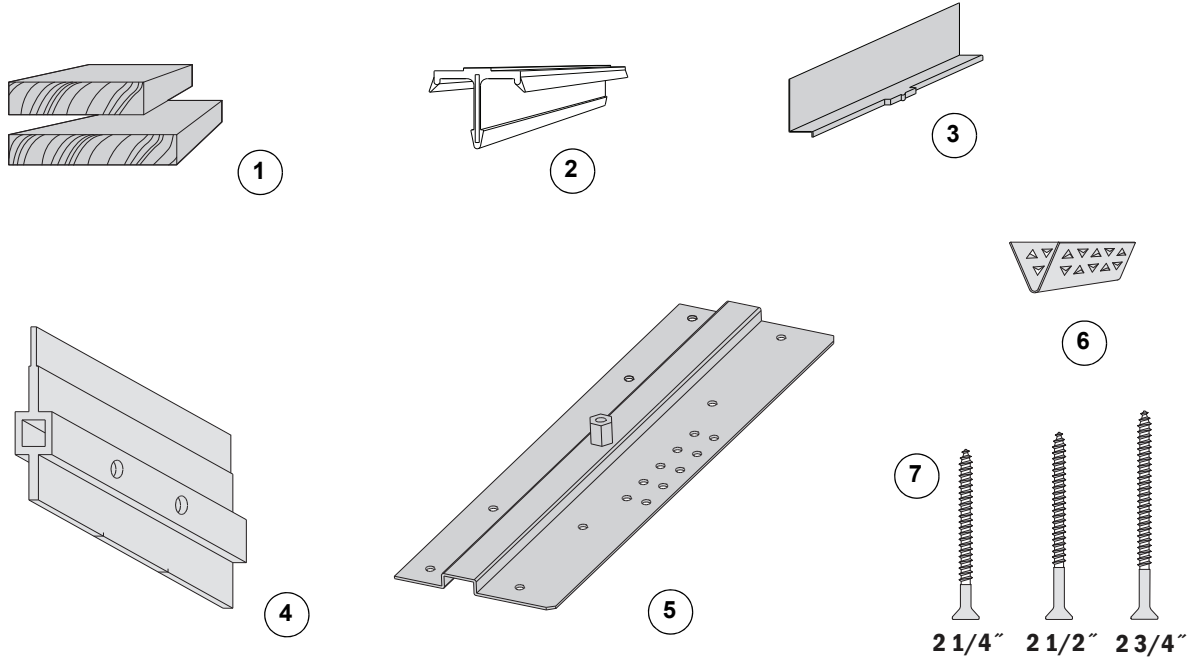

**Aluminum Reinforced Narrow Mullion
for Casement, Awning, Specialty, and Circle Top™ Windows**

Inside Casing - Aluminum Reinforced Mullion Ref. No. 1

	Length	2 3/8"	2 5/8"	2 7/8"
		Casement to Casement	Casement to Flexiframe	Flexiframe to Flexiframe
96"		1349022	1386812	1507622
144"		1349024	1386814	1507624

Exterior Trim Strip - Reinforced Mullion Ref. No. 2

Unit Size	White	Terratone	Sandtone	Forest Green	Canvas	Dark Bronze	Black
96"	2340504	2340508	2340512	2340528	9043184	9074013	9129253
150"	2340502	2340506	2340510	2340526	9043183	9074012	9129252

Exterior Flashing Ref. No. 3

Length	White	Terratone	Sandtone	Forest Green	Canvas	Dark Bronze	Black
6"	1356008	1456008	0608402	0514129	9033568	9073185	9127237

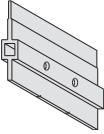
Joining Strip - Reinforced Mullion Ref. No. 4			
		Unit Size	Order No.
		72 ³ / ₃₂ "	2340402
		92"	2340404

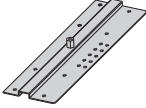
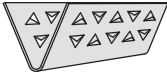
End Plate Kit - Reinforced Mullion / PSC/A/CT/FF Ref. No. 5, 6, and 7 page 27			
	Includes: End plates, trim strip clip, and screws		Order No.
			2340412
End Plate - Reinforced Mullion Ref. No. 5 page 27			
			Order No.
			2340422
Trim Clip - Reinforced Mullion Ref. No. 6 page 27			
			Order No.
			2340423

400 Series Flexiframe® Windows (1985 to Present)

Reinforced Mull Joining Components - LVL

Joining Kit Graphic

Notes:

See [Joining Guide 0005381](#)

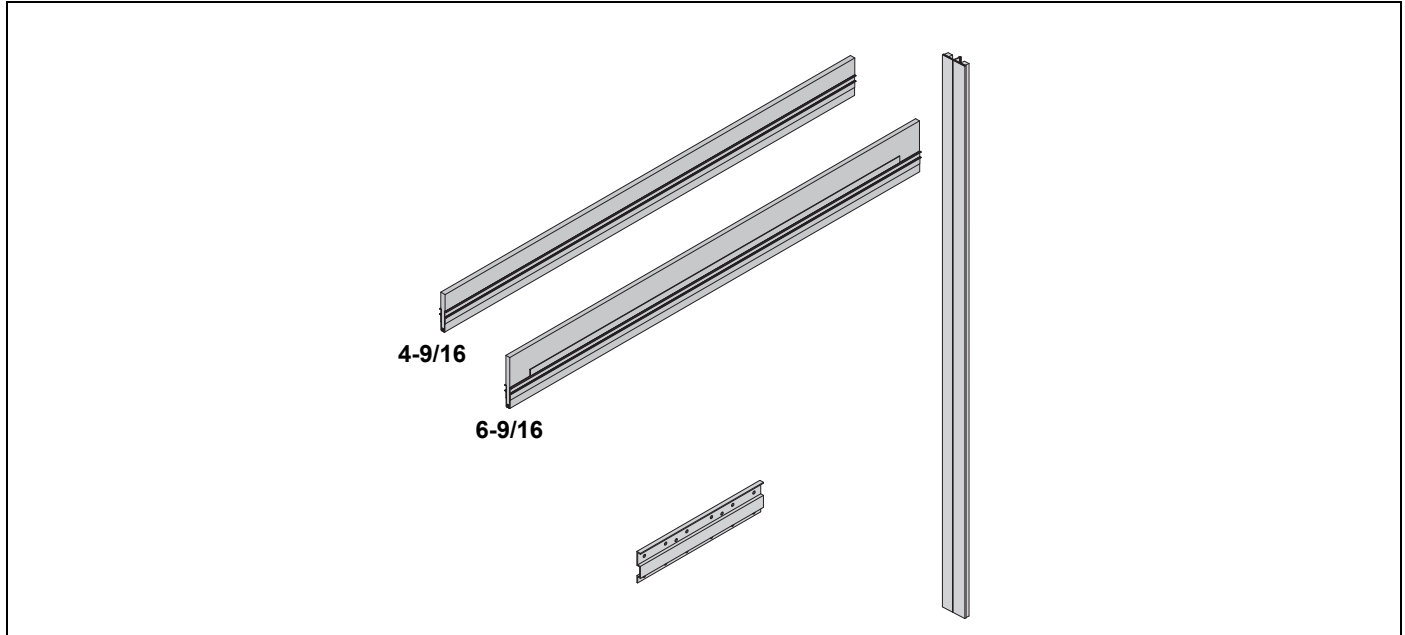

Joining Kit - 3/4" LVL / One-Way / 4 9/16" Wall

- | | |
|---|---------------------------|
| Kit Includes: | (4) #10-12 x 3" screws |
| (2) Gusset plates | (28) #8-15 x 3" screws |
| (1) 3/4" LVL joining strip 4-9/16" Wall | (3) #8-18 x 1-3/4" screws |
| (4) Foam void filler | (12) #10 x 2-1/2" screws |
| (1) Exterior trim strip | |

Unit No	Length	White	Terratone	Sandtone	Forest Green	Canvas	Dark Bronze	Black
PSCA60	6'	1320953	1439603	0614203	0519303	9076738	9076970	9129361
PSCA80	8'	1320917	1439607	0614207	0519307	9076742	9076974	9129365

Joining Kit - LVL / One-Way / 6 9/16" Wall

Note:

Kit contains the same parts as above but includes the wider 3/4" LVL joining strip 6-9/16" Wall.

Unit No	Length	White	Terratone	Sandtone	Forest Green	Canvas	Dark Bronze	Black
PSCA60	6'	1320920	1439610	0614210	0519310	9076745	9076977	9129368
PSCA80	8'	1320921	1439611	0614211	0519311	9076746	9076978	9129369
PSCA100	10'	1320922	1439612	0614212	0519312	9076747	9076979	9129370

Joining Kit Graphic

Notes:

See [Joining Guide 0005383](#)

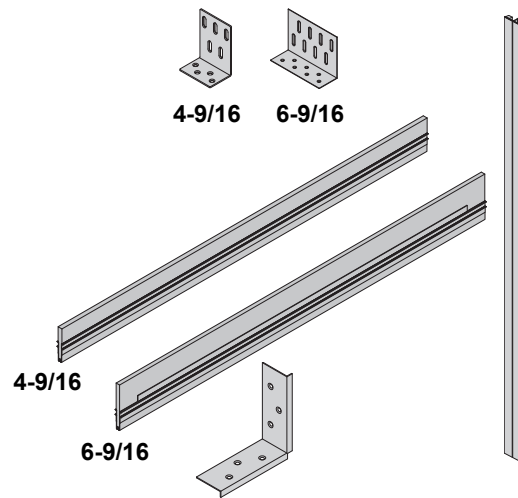

Joining Kit - 3/4" LVL / Two-Way / 6 9/16" Wall

Kit Includes:

- (2) 3/4" Joining brackets 6-9/16 Wall
- (1) 3/4" LVL joining strip 6-9/16" Wall
- (4) Foam void filler
- (1) Exterior trim strip
- (2) Intersection brackets
- (4) #10-12 x 3" screws
- (14) #8-15 x 3" screws
- (16) #8 x 3/4" bracket screws
- (8) #8-18 x 1-3/8" screws
- (18) #10 x 2-1/2" screws

Unit No	Length	White	Terratone	Sandtone	Forest Green	Canvas	Dark Bronze	Black
PSCA60	6'	1320954	1439604	0614204	0519304	9076739	9076971	9129362
PSCA80	8'	1320955	1439605	0614205	0519305	9076740	9076972	9129363
PSCA100	10'	1320956	1439606	0614206	0519306	9076741	9076973	9129364

Joining Kit - LVL / Two-Way / 4 9/16" Wall

Note:

Kit contains the same parts as above but includes:
 (2) 3/4 Joining brackets 4-9/16" Wall and (1) 4-9/16" 3/4" LVL joining strip 4-9/16" Wall.

Unit No	Length	White	Terratone	Sandtone	Forest Green	Canvas	Dark Bronze	Black
PSCA60	6'	1320918	1439608	0614208	0519308	9076743	9076975	9129366
PSCA80	8'	1320919	1439609	0614209	0519309	9076744	9076976	9129367

400 Series Flexiframe® Windows (1985 to Present)

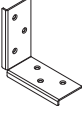
Intersection Bracket - 3/4" 4-9/16 LVL		
	Note: Used in both 4-9/16" & 6-9/16" kits	Order No.
		1601635

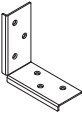
L Bracket - 3/4" 7-9/16 LVL		
	Note: Structural bracket	Order No.
		2573481

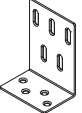
Load Transfer Bracket - 3/4" LVL / 4 9/16" Wall		
		Order No.
		1601636

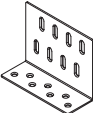
Load Transfer Bracket - 3/4" LVL / 6 9/16" Wall		
		Order No.
		1600202

Joining Strip - 3/4" LVL / 4 9/16" Wall		
		Order No.
		1302199

Joining Components

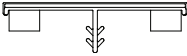
Trim Strip - Exterior - 3/4" LVL								
								
Unit No	Length	White	Terratone	Sandtone	Forest Green	Canvas	Dark Bronze	Black
PSCA60	71 7/8	1300075	1400592	0600197	0501029	9033564	9073862	9129250
PSCA80	96	1300076	1400593	0600198	0501030	9033565	9073182	9129216
PSCA100	120	1300077	1400594	0600199	0501031	9033566	9073183	9129217

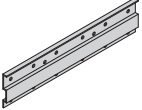
Joining Strip - 3/4" LVL / 6 9/16" Wall		
	Unit No.	Order No.
	C20	1300088
	C96	1300087
Gusset Plate - 18" Reinforced		
		Order No.
		1600199

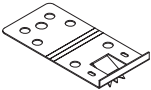
Installation Clip Kit with Screws		
	Kit includes: (10) Jamb clips (20) Clip screws	Order No.
		1376706

400 Series Flexiframe® Windows (1985 to Present)

Standard Windows

Art Glass Components

Art Glass Components

Art Glass

Note:

Information about ordering replacement art glass panels can be found in the Andersen Art Glass section of the catalog.

Art Glass Trim Stops

Trim Stop - Art Glass / Side

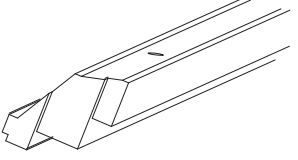
		Unit No.	Length	Order No.
		AG PSFF68	67 1/2	2370178
		AG PSFF611	70 7/16	2370177
		AG PSFF80	83 1/2	2370180

Trim Stop - Art Glass / Head and Sill

	Unit No.	Length	Order No.
	AG 8'	96"	9033187

Art Glass Hardware

Bracket Package - Top and Bottom

	Package includes: Shims and screws	Order No.
		2370020

Bracket with Screws - Top Only

	Order No.
	2370024

Screw Head Package

	Description	Order No.
	Brass oval head / AG 1x5 STD	2370026

Art Glass Components

400 Series Flexiframe® Windows (1985 to Present)

Stormwatch™ Protection (Coastal Product)

Frame (Impact Resistant)

Stormwatch™ Protection (Coastal Product)

Note:

Andersen® products with Stormwatch protection are designed for use in coastal areas. They feature design pressure upgrades, glass options, and structural enhancements. Sash are notched for grilles.

Frame (Impact Resistant)

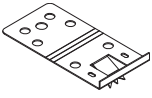
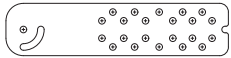
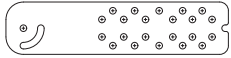
Installation Kits for Standard and Impact Resistant Units					
Jamb Clip Kit - 3"					
	Kit includes: 18 - jamb clips 36 - 8-18 x 1-1/4 PH FL 316 SS PASS TYP AB screws 1 instruction sheet	Order No.			
		1399980			
Jamb Clip Kit - 6" (for units with pre-applied extension jambs)					
	Kit includes: Jamb clips and screws for Tilt-Wash Double-Hung Picture IR window, Casement Picture window, Flexiframe window, Arch window. Note: For use with pre-applied extension jambs. Made of 304 annealed stainless steel, making it compatible with ACQ treated lumber. These clips are approved for use with all Stormwatch products and for Miami-Dade County. The clips are pre-punched with holes for unit installation in wall thicknesses from 4-9/16" to 7-1/8". Additional pre-punched holes are available to compensate for wall thickness variations.	Quantity	Clip Dimensions	Order No.	
		18 clips	6 3/8 x 1 1/2	9014868	
Jamb Clips - 6" (for units with pre-applied extension jambs)					
			Quantity	Clip Dimensions	Order No.
			500 clips	6 3/8 x 1 1/2	1376707

Frame (Impact Resistant)

Notes

400 Series Flexiframe® Windows (1985 to Present)

Service Replacement

Service Replacement Only Parts

Service Replacement

Service Replacement Only Parts

Service Replacement Only Parts

Note:

This section is specifically designed for parts that should only be ordered if a Field Service Manager/Service Provider has requested them to be ordered or if the customer agrees to also pay for a non-warranty repair/replace service job (subject to availability) for these parts to be installed. We do not recommend anyone other than a trained AW employee or Service Provider install these parts due to the complexity of installation, modifications required for installation and/or requirement of special tools.

Interior Grilles - Contemporary

Note:

Permanently applied grilles can only be ordered by Andersen Territory Service Representatives, Andersen Service Dealers and Providers.

Interior Grilles - Contemporary / 96" Taped

	Color	3/4"	2 1/4"
	White	9189462	9189463
	Terratone	9189466	9189467
	Sandtone	9189460	9189461
	Forest Green	9189464	9189465
	Canvas	9189468	9189469
	Prairie Grass	9189476	9189477
	Cocoa Bean	9189470	9189471
	Dove Gray	9189474	9189475
	Red Rock	9189490	9189491
	Dark Bronze	9189486	9189487
	Black	9189488	9189489

Interior Grilles - Contemporary / 144" Taped

	Color	3/4"	2 1/4"
	White	9189480	9189481
	Terratone	9189484	9189485
	Sandtone	9189478	9189479
	Forest Green	9189482	9189483
	Canvas	9189492	9189493
	Prairie Grass		9189507
	Cocoa Bean	9189498	9189499
	Dove Gray	9189504	9189505
	Red Rock	9189500	9189501
	Dark Bronze	9189494	9189495
	Black	9189496	9189497

Service Replacement Only Parts

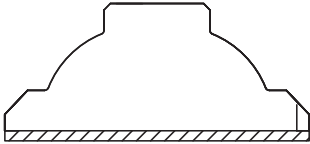
Exterior Grilles - HDN									
Exterior Grille - HDN / Lineal / PVC									
Note: These grilles can only be ordered by SAR/SPC.									
									
Length	White			Terratone			Sandtone		
	3/4"	7/8"	1 1/8"	3/4"	7/8"	1 1/8"	3/4"	7/8"	1 1/8"
60"	2322030	2322034	2322038	N/A	N/A	N/A	N/A	N/A	N/A
84"	2322031	2322035	2322039	N/A	N/A	N/A	N/A	N/A	N/A