

<b>What's in This Section</b>
-------------------------------

<b>Standard Windows</b> .....	<b>Page 3</b>
<b>Parts Illustration</b> .....	<b>3</b>
Parts Illustration .....	3
Colors - Exterior .....	4
Colors/Species/Finishes - Interior .....	5
<b>Unit Sizes</b> .....	<b>6</b>
Standard and Custom Window Sizes .....	6
E Series Product Label .....	6
Unit Size Chart - Standard Windows .....	7
<b>Product History</b> .....	<b>8</b>
Product History .....	8
<b>Sash</b> .....	<b>9</b>
Sash Size Table .....	9
Sash Graphic - Operating .....	11
Sash Options - Operating .....	12
Sash Graphic - Stationary .....	13
Sash Options - Stationary .....	14
Sash Parts .....	15
Sash Hardware / Lift (Pull) .....	16
Sash Hardware / Lock & Keeper .....	17
Sash Hardware / Roller .....	18
<b>Glass</b> .....	<b>19</b>
Glass .....	19
Glass Stops .....	20
Glass Parts .....	21
<b>Insect Screens</b> .....	<b>22</b>
Insect Screen Graphic - Full .....	22
Insect Screen Size Table - Full .....	23
Insect Screen Graphic - Half .....	24
Insect Screen Size Table - Half .....	25
Insect Screen Retainer .....	27
Insect Screen Parts .....	28
<b>Grilles</b> .....	<b>29</b>
Grilles .....	29
Grille Options .....	30
Interior Grille Parts .....	31
<b>Frames</b> .....	<b>32</b>

Frame Graphic - Vertical / Horizontal .....	32
Frame Graphic - Top/Bottom View .....	33
Frame .....	34
Stops .....	35
Weatherstrip .....	36
Frame Parts .....	37



**Parts Illustration**

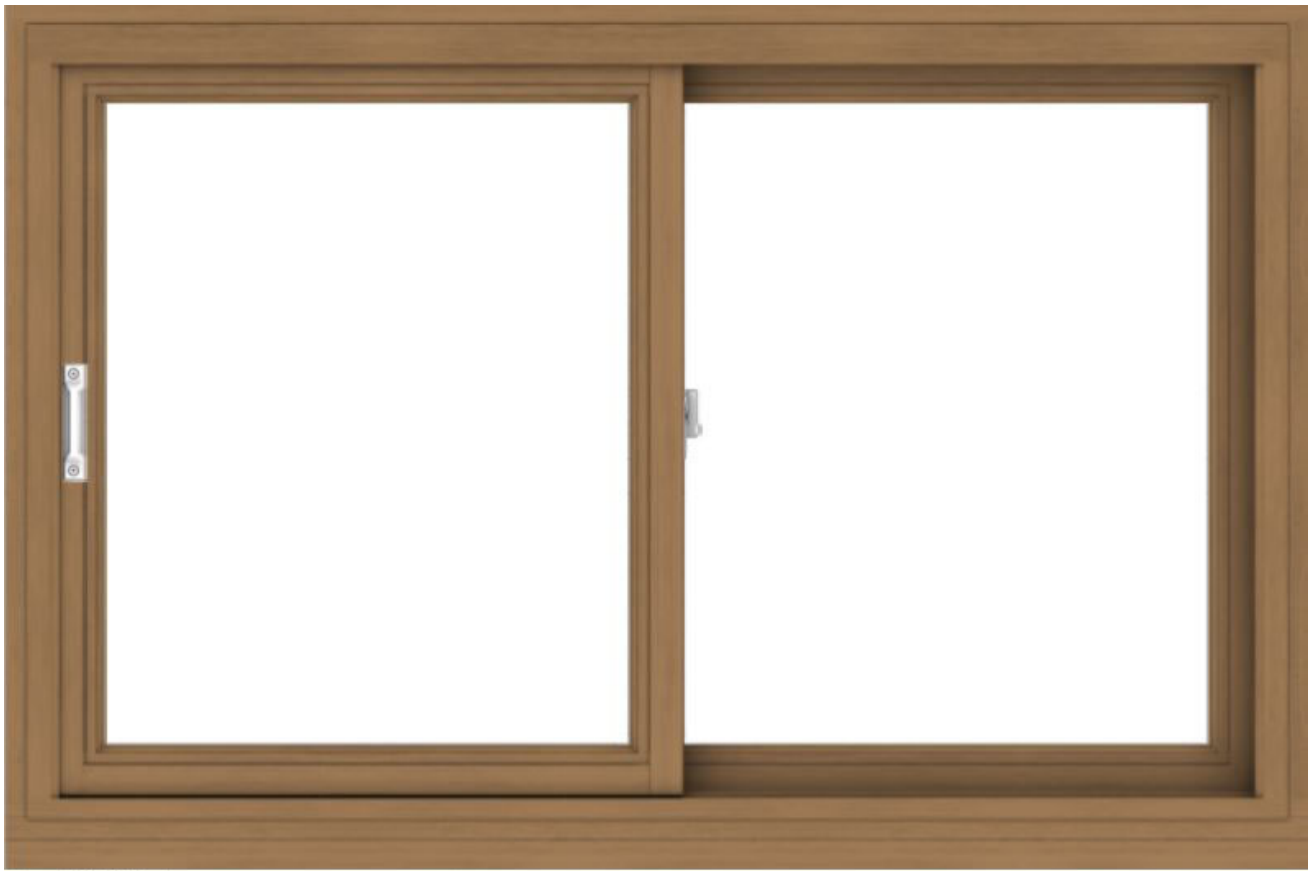

**E-Series Gliding Window Unit Parts**

*Unit viewed from interior*

## Parts Illustration

### Colors - Exterior

**Note:**  
(\* ) Anodized Finishes

				Colony White	White	Abalone	Balsa White
			Canvas	Maple Syrup	Harvest Gold	Prairie Grass	
Flagstone	Sandtone	Pebble Tan	Carmel	Terratone	Hot Chocolate	Bourbon	
Acorn	Coffee Bean	Cocoa Bean	Sierra Bronze	Dark Bronze	Clay Canyon	Red Rock	
Cardinal	Bing Cherry	Fire Engine Red	Cinnamon Toast	Olive	Sage	Billiard Green	
Moss	Forest Green	Mallard Green	Spearmint	Aquamarine	Patina	Sky Blue	
Country Blue	Blue Denim	Watercolor Blue	Caribbean Blue	Slate	Moody Blue	Stormy Blue	
Dove Gray	Harbor Mist	Yorktown Pewter	Smokey Gray	Mystic Gray	Dark Ash	Black	
Light Bronze*	Champagne*	Clear Anodized*	Black	Dark Bronze*	Copper*	Medium Bronze*	

### Colors/Species/Finishes - Interior

#### Species Interior Options



Pine



Mixed Grain  
Douglas Fir



Oak



Maple

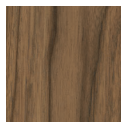

Walnut



Alder

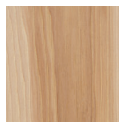

Hickory



Mahogany



Vertical Grain  
Douglas Fir



Cherry



White Oak

#### Stained Interior Options



Clear Coat



Wheat



Autumn Oak



Golden Hickory



Honey

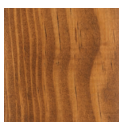

Cinnamon

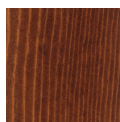

Russet



Mocha

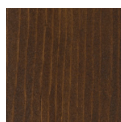

Espresso

#### Painted Interior Options

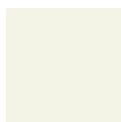

White



Birch Bark



Primed



Canvas



Sandtone



Terratone



Forest Green



Dark Bronze



Dove Gray



Prairie Grass



Red Rock



Cocoa Bean



Black



Anodized Silver <sup>1</sup>

## Unit Sizes

---

### Standard and Custom Window Sizes

**Note:**

E-Series Gliding Windows are available in standard sizes (see standard size charts, [page 7](#)). Replacement parts for some standard windows can be ordered using the numbers listed in this catalog. Many replacement parts for standard windows are made to order. These items are ordered using the Product ID found on the identification label and a description of the part needed. See [Service Guide 9051877](#).

E-Series Gliding Windows are also available in custom sizes in 1/8" increments between the smallest and the largest standard sizes. Most replacement parts for custom-sized windows are made to order and can be ordered with the Product ID found on the identification label and a description of the part needed. See [Service Guide 9051877](#).

### E Series Product Label

**Note:**

Every E-Series Gliding Windows will have an identification label or glass etching containing a unique Product ID. The Product ID on E-Series Gliding Window will be located at the top of the window frame or etched into the glass. See [Service Guide 9051877](#). The Product ID may be up to 14 digits long (excluding hyphens), depending on the age of the unit. Replacement parts will also get their own unique Product ID. When ordering replacement parts, providing the Product ID ensures that replacement parts match the specifications.

### Unit Size Chart - Standard Windows

**Note:**

Unit Dimension refers to overall outside-to-outside frame. V.G. refers to visible glass dimensions. See current unit [Size Details](#).

#### 2-Sash Gliding Window Sizes

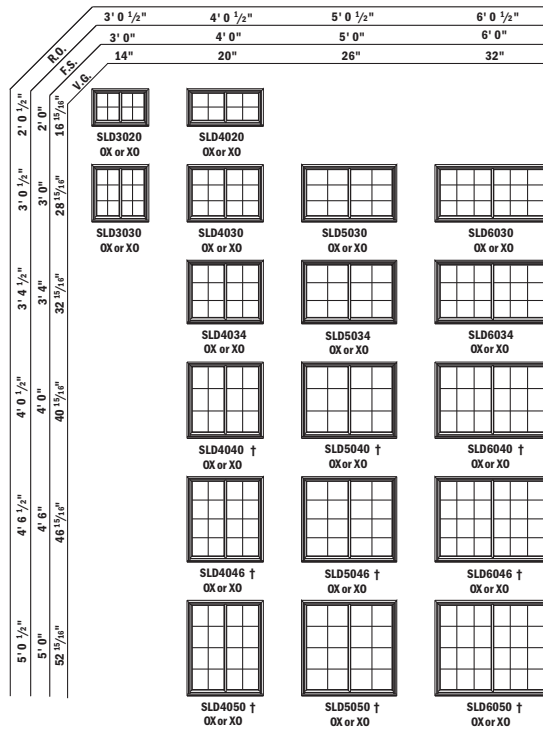

#### 3-Sash Gliding Window Sizes

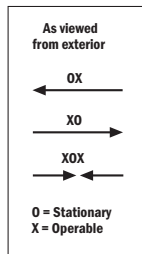
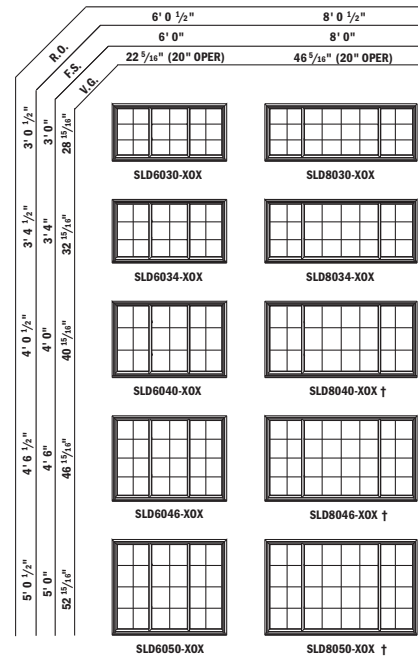

**NOTES**

† These units meet or exceed the following dimensions: Clear Opening Area 5.7 sq. ft., Clear Opening Height 24" and 44" maximum floor to sill height (with standard 6' 10-1/2" structural header height). See your local code official for requirements in your area.

3-sash gliding units use 2' 0" operating sash as a standard. Additional sash ratios also available.

The light patterns illustrated apply to rectangular removable interior wood grilles. Full Divided Light, Simulated Divided Light, Decorelle 100, 150 and 400 and Finelight™ Grilles-Between-the-Glass. All removable interior wood grilles will be installed in the units unless otherwise specified.

For a metric conversion in millimeters, multiply dimensions in inches by 25.4

## Product History

---

### Product History

**2022** Stormwatch® (not shown in catalog) discontinued. See [Bulletin 80-21](#) for more detail.

# E-Series Gliding Windows (May 2002 to 2013)

Standard Windows

## Sash

### Sash Size Table

**Note:**

Overall Sash is measured outside edge to outside edge of sash frame.

### Sash Size Table - OX/XO Units

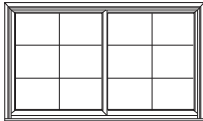
Unit No.		Sash Dimensions Operating Sash (w x h)	Sash Dimensions Stationary Sash (w x h)	Visible Glass Dimensions (w x h)	Graphic
<b>30</b>	<b>SLD3020</b>	17 <sup>5</sup> / <sub>16</sub> x 20 <sup>3</sup> / <sub>16</sub>	17 <sup>1</sup> / <sub>4</sub> x 20 <sup>3</sup> / <sub>16</sub>	14 x 16 <sup>15</sup> / <sub>16</sub>	
	<b>SLD3030</b>	17 <sup>5</sup> / <sub>16</sub> x 32 <sup>3</sup> / <sub>16</sub>	17 <sup>1</sup> / <sub>4</sub> x 32 <sup>3</sup> / <sub>16</sub>	14 x 28 <sup>15</sup> / <sub>16</sub>	
<b>40</b>	<b>SLD4020</b>	23 <sup>5</sup> / <sub>16</sub> x 20 <sup>3</sup> / <sub>16</sub>	23 <sup>1</sup> / <sub>4</sub> x 20 <sup>3</sup> / <sub>16</sub>	20 x 16 <sup>15</sup> / <sub>16</sub>	
	<b>SLD4030</b>	23 <sup>5</sup> / <sub>16</sub> x 32 <sup>3</sup> / <sub>16</sub>	23 <sup>1</sup> / <sub>4</sub> x 32 <sup>3</sup> / <sub>16</sub>	20 x 28 <sup>15</sup> / <sub>16</sub>	
	<b>SLD4034</b>	23 <sup>5</sup> / <sub>16</sub> x 36 <sup>3</sup> / <sub>16</sub>	23 <sup>1</sup> / <sub>4</sub> x 36 <sup>3</sup> / <sub>16</sub>	20 x 32 <sup>15</sup> / <sub>16</sub>	
	<b>SLD4040</b>	23 <sup>5</sup> / <sub>16</sub> x 44 <sup>3</sup> / <sub>16</sub>	23 <sup>1</sup> / <sub>4</sub> x 44 <sup>3</sup> / <sub>16</sub>	20 x 40 <sup>15</sup> / <sub>16</sub>	
	<b>SLD4046</b>	23 <sup>5</sup> / <sub>16</sub> x 50 <sup>3</sup> / <sub>16</sub>	23 <sup>1</sup> / <sub>4</sub> x 50 <sup>3</sup> / <sub>16</sub>	20 x 46 <sup>15</sup> / <sub>16</sub>	
	<b>SLD4050</b>	23 <sup>5</sup> / <sub>16</sub> x 56 <sup>3</sup> / <sub>16</sub>	23 <sup>1</sup> / <sub>4</sub> x 56 <sup>3</sup> / <sub>16</sub>	20 x 52 <sup>15</sup> / <sub>16</sub>	
<b>50</b>	<b>SLD5020</b>	29 <sup>5</sup> / <sub>16</sub> x 20 <sup>3</sup> / <sub>16</sub>	29 <sup>1</sup> / <sub>4</sub> x 20 <sup>3</sup> / <sub>16</sub>	26 x 16 <sup>15</sup> / <sub>16</sub>	
	<b>SLD5030</b>	29 <sup>5</sup> / <sub>16</sub> x 32 <sup>3</sup> / <sub>16</sub>	29 <sup>1</sup> / <sub>4</sub> x 32 <sup>3</sup> / <sub>16</sub>	26 x 28 <sup>15</sup> / <sub>16</sub>	
	<b>SLD5034</b>	29 <sup>5</sup> / <sub>16</sub> x 36 <sup>3</sup> / <sub>16</sub>	29 <sup>1</sup> / <sub>4</sub> x 36 <sup>3</sup> / <sub>16</sub>	26 x 32 <sup>15</sup> / <sub>16</sub>	
	<b>SLD5040</b>	29 <sup>5</sup> / <sub>16</sub> x 44 <sup>3</sup> / <sub>16</sub>	29 <sup>1</sup> / <sub>4</sub> x 44 <sup>3</sup> / <sub>16</sub>	26 x 40 <sup>15</sup> / <sub>16</sub>	
	<b>SLD5046</b>	29 <sup>5</sup> / <sub>16</sub> x 50 <sup>3</sup> / <sub>16</sub>	29 <sup>1</sup> / <sub>4</sub> x 50 <sup>3</sup> / <sub>16</sub>	26 x 46 <sup>15</sup> / <sub>16</sub>	
	<b>SLD5050</b>	29 <sup>5</sup> / <sub>16</sub> x 56 <sup>3</sup> / <sub>16</sub>	29 <sup>1</sup> / <sub>4</sub> x 56 <sup>3</sup> / <sub>16</sub>	26 x 52 <sup>15</sup> / <sub>16</sub>	
<b>60</b>	<b>SLD6020</b>	35 <sup>5</sup> / <sub>16</sub> x 20 <sup>3</sup> / <sub>16</sub>	35 <sup>1</sup> / <sub>4</sub> x 20 <sup>3</sup> / <sub>16</sub>	32 x 16 <sup>15</sup> / <sub>16</sub>	
	<b>SLD6030</b>	35 <sup>5</sup> / <sub>16</sub> x 32 <sup>3</sup> / <sub>16</sub>	35 <sup>1</sup> / <sub>4</sub> x 32 <sup>3</sup> / <sub>16</sub>	32 x 28 <sup>15</sup> / <sub>16</sub>	
	<b>SLD6034</b>	35 <sup>5</sup> / <sub>16</sub> x 36 <sup>3</sup> / <sub>16</sub>	35 <sup>1</sup> / <sub>4</sub> x 36 <sup>3</sup> / <sub>16</sub>	32 x 32 <sup>15</sup> / <sub>16</sub>	
	<b>SLD6040</b>	35 <sup>5</sup> / <sub>16</sub> x 44 <sup>3</sup> / <sub>16</sub>	35 <sup>1</sup> / <sub>4</sub> x 44 <sup>3</sup> / <sub>16</sub>	32 x 40 <sup>15</sup> / <sub>16</sub>	
	<b>SLD6046</b>	35 <sup>5</sup> / <sub>16</sub> x 50 <sup>3</sup> / <sub>16</sub>	35 <sup>1</sup> / <sub>4</sub> x 50 <sup>3</sup> / <sub>16</sub>	32 x 46 <sup>15</sup> / <sub>16</sub>	
	<b>SLD6050</b>	35 <sup>5</sup> / <sub>16</sub> x 56 <sup>3</sup> / <sub>16</sub>	35 <sup>1</sup> / <sub>4</sub> x 56 <sup>3</sup> / <sub>16</sub>	32 x 52 <sup>15</sup> / <sub>16</sub>	

## Sash

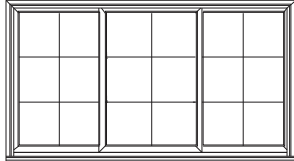
Sash Size Table - XOX Units				
<b>Note:</b> 3-sash gliding units (XOX) use 2'0" operating sash as standard. Additional sash ratios also available.				
Unit No.	Sash Dimensions Fixed Sash (w x h)	Visible Glass Dimensions (w x h)	Graphic	
<b>60</b>	<b>SLD6020</b>	25 <sup>9</sup> / <sub>16</sub> x 20 <sup>3</sup> / <sub>16</sub>	22 <sup>5</sup> / <sub>16</sub> x 16 <sup>15</sup> / <sub>16</sub>	
	<b>SLD6030</b>	25 <sup>9</sup> / <sub>16</sub> x 32 <sup>3</sup> / <sub>16</sub>	22 <sup>5</sup> / <sub>16</sub> x 28 <sup>15</sup> / <sub>16</sub>	
	<b>SLD6034</b>	25 <sup>9</sup> / <sub>16</sub> x 36 <sup>3</sup> / <sub>16</sub>	22 <sup>5</sup> / <sub>16</sub> x 32 <sup>15</sup> / <sub>16</sub>	
	<b>SLD6040</b>	25 <sup>9</sup> / <sub>16</sub> x 44 <sup>3</sup> / <sub>16</sub>	22 <sup>5</sup> / <sub>16</sub> x 40 <sup>15</sup> / <sub>16</sub>	
	<b>SLD6046</b>	25 <sup>9</sup> / <sub>16</sub> x 50 <sup>3</sup> / <sub>16</sub>	22 <sup>5</sup> / <sub>16</sub> x 46 <sup>15</sup> / <sub>16</sub>	
	<b>SLD6050</b>	25 <sup>9</sup> / <sub>16</sub> x 56 <sup>3</sup> / <sub>16</sub>	22 <sup>5</sup> / <sub>16</sub> x 52 <sup>15</sup> / <sub>16</sub>	
<b>80</b>	<b>SLD8020</b>	49 <sup>9</sup> / <sub>16</sub> x 20 <sup>3</sup> / <sub>16</sub>	46 <sup>5</sup> / <sub>16</sub> x 16 <sup>15</sup> / <sub>16</sub>	
	<b>SLD8030</b>	49 <sup>9</sup> / <sub>16</sub> x 32 <sup>3</sup> / <sub>16</sub>	46 <sup>5</sup> / <sub>16</sub> x 28 <sup>15</sup> / <sub>16</sub>	
	<b>SLD8034</b>	49 <sup>9</sup> / <sub>16</sub> x 36 <sup>3</sup> / <sub>16</sub>	46 <sup>5</sup> / <sub>16</sub> x 32 <sup>15</sup> / <sub>16</sub>	
	<b>SLD8040</b>	49 <sup>9</sup> / <sub>16</sub> x 44 <sup>3</sup> / <sub>16</sub>	46 <sup>5</sup> / <sub>16</sub> x 40 <sup>15</sup> / <sub>16</sub>	
	<b>SLD8046</b>	49 <sup>9</sup> / <sub>16</sub> x 50 <sup>3</sup> / <sub>16</sub>	46 <sup>5</sup> / <sub>16</sub> x 46 <sup>15</sup> / <sub>16</sub>	
	<b>SLD8050</b>	49 <sup>9</sup> / <sub>16</sub> x 56 <sup>3</sup> / <sub>16</sub>	46 <sup>5</sup> / <sub>16</sub> x 52 <sup>15</sup> / <sub>16</sub>	



### Sash Graphic - Operating

**Note:**

See current sash [Product Details](#). New drawing 0216

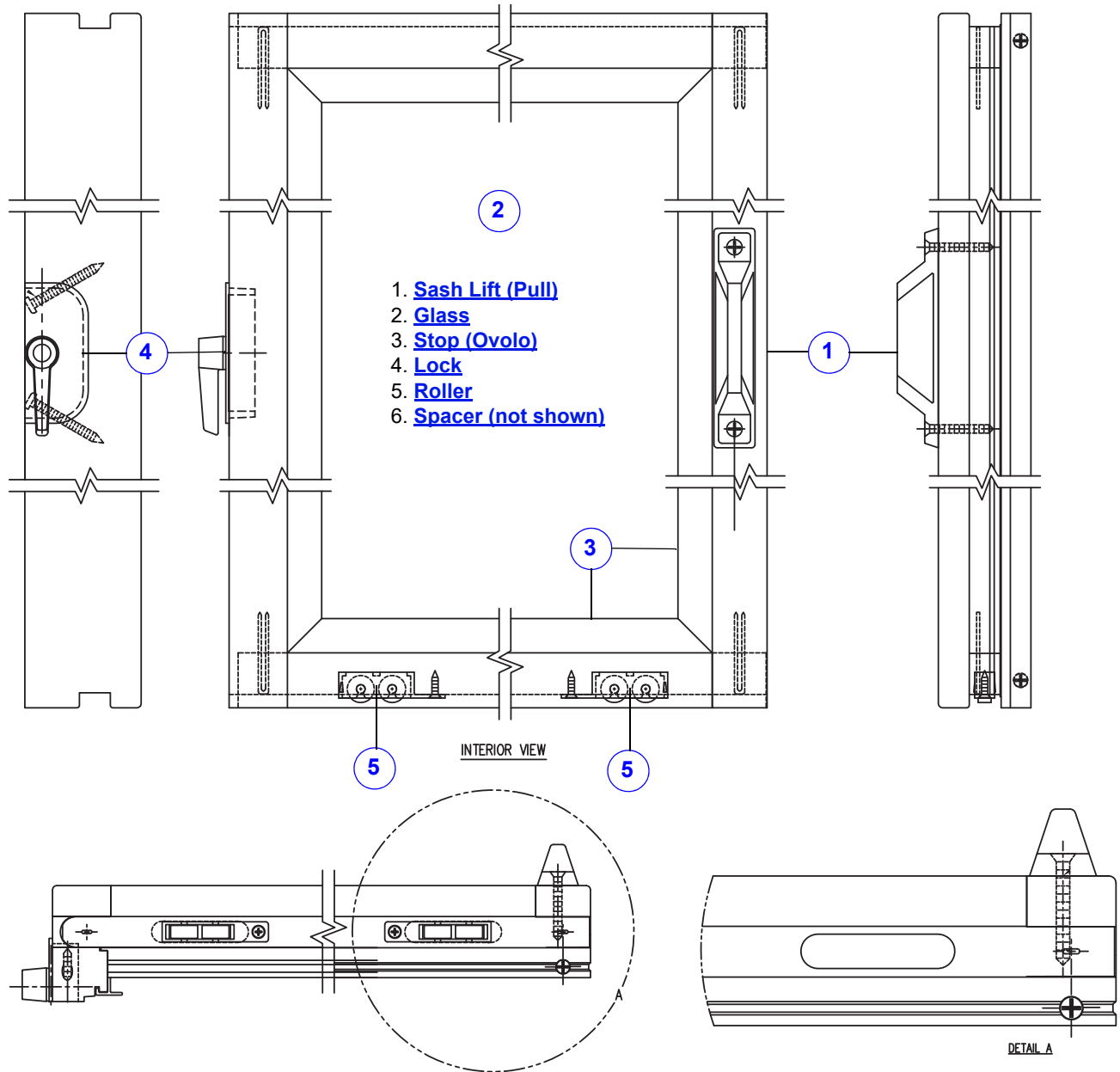

**E-Series Gliding Window Sash - Operating**

# Sash

## Sash Options - Operating

### Sash - Standard Window

**Note:**

Replacement glass is made to order and can be configured through iQ. Current glazings replace previous vintage glazings. Product ID label is located on the head jamb. See [Service Guide 9069179](#) for sash replacement instructions.

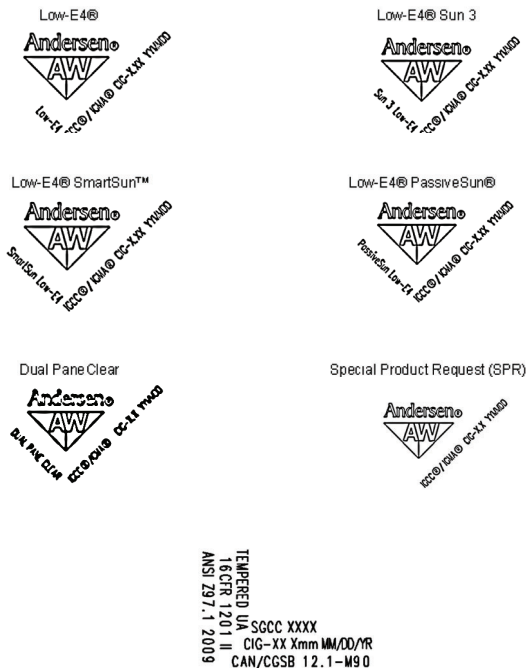

**Exterior color options:**  
**Interior species/finish/color options:**  
**Glass options (See Logo/Etching Examples):**

Low-E4®	Low-E4® HeatLock	Low-E4® Triple-Pane
Low-E4® SmartSun™	Low-E4® Smart-Sun HeatLock	Low-E4® Smart-Sun Triple-Pane
Low-E4® Passive Sun	Low-E4® Sun Heat-Lock	Low-E4® Enhanced Triple-Pane
Low-E4® Sun 3	Low-E4® HeatLock Tempered	Low-E4® Smart-Sun Enhanced Triple-Pane
Low-E4® Tempered	Dual Pane Clear	Low-E4® Enhanced Triple-Pane Heat-Lock
Low-E4® SmartSun Tempered	Cascade	Low-E4® Smart-Sun Enhanced Triple-Pane HeatLock
Low-E4® Passive Sun Tempered	Fern	
Low-E4® Sun Tempered	Reed	

To order, state:

Product ID (from product label, see [Service Guide 9051877](#))  
 OR

1. Unit or frame size (CSLD XXXX or frame W x H dimensions)
2. Type (Double, Triple)
3. Unit sash ratio (Double - Standard, Special ; Triple - Standard,  $\frac{1}{4} - \frac{1}{2} - \frac{1}{4}$ ,  $\frac{1}{3} - \frac{1}{3} - \frac{1}{3}$ )
4. Description of part (Operating Sash)
5. Exterior color of sash
6. Hardware finish of keeper
7. Interior wood species/finish/color of sash
8. Glazing/Grille type

### Double Sash Ratio



Standard

Special

### Triple Sash Ratio

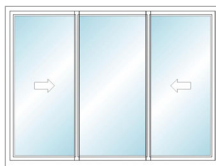

Standard (24" flanker)

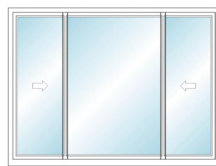

$\frac{1}{4} - \frac{1}{2} - \frac{1}{4}$

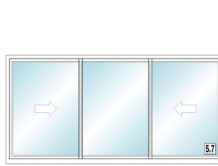

$\frac{1}{3} - \frac{1}{3} - \frac{1}{3}$

### Sash Graphic - Stationary

**Note:**

See current sash [Product Details](#). New drawing 0217

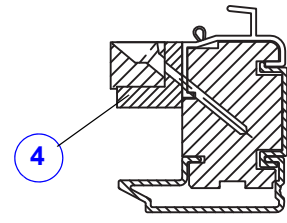
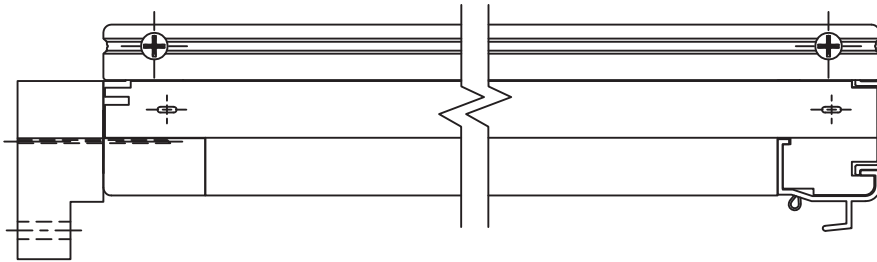

SECTION A-A

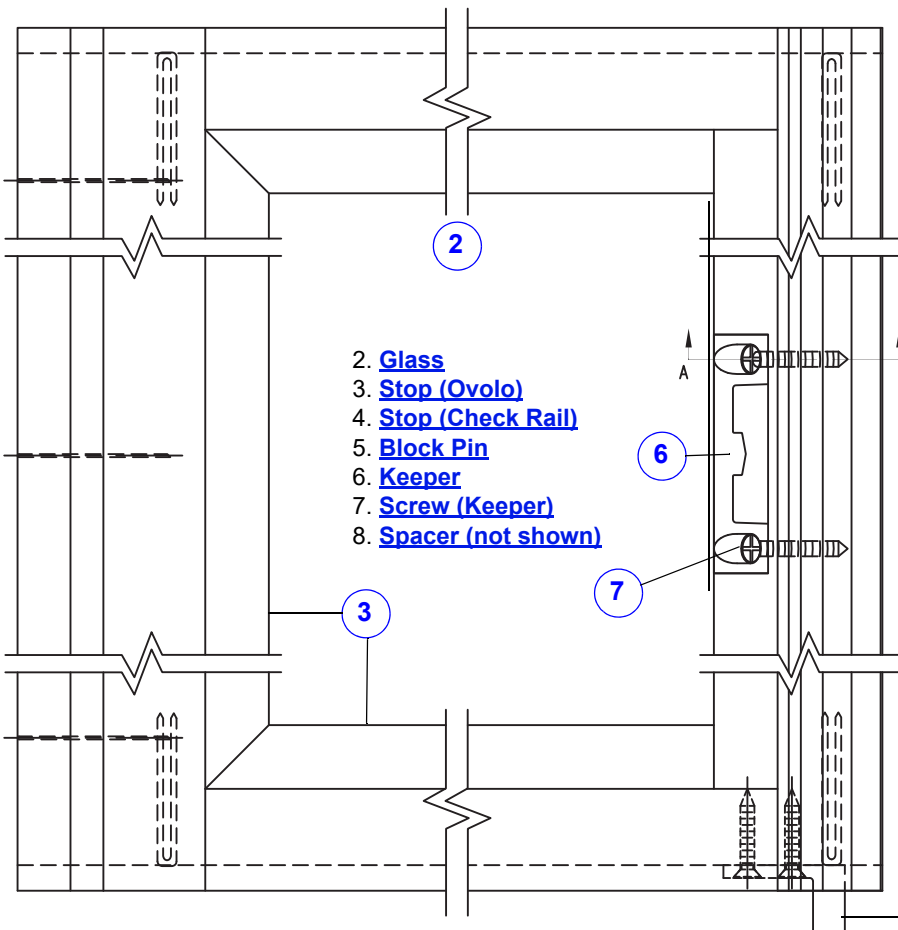

- 2. [Glass](#)
- 3. [Stop \(Ovolo\)](#)
- 4. [Stop \(Check Rail\)](#)
- 5. [Block Pin](#)
- 6. [Keeper](#)
- 7. [Screw \(Keeper\)](#)
- 8. [Spacer \(not shown\)](#)

INTERIOR VIEW

### E-Series Gliding Window Sash - Stationary

# Sash

## Sash Options - Stationary

### Sash - Standard Window

**Note:**

Replacement glass is made to order and can be configured through iQ. Current glazings replace previous vintage glazings. Product ID label is located on the head jamb. See [Service Guide 9069179](#) for sash replacement instructions.

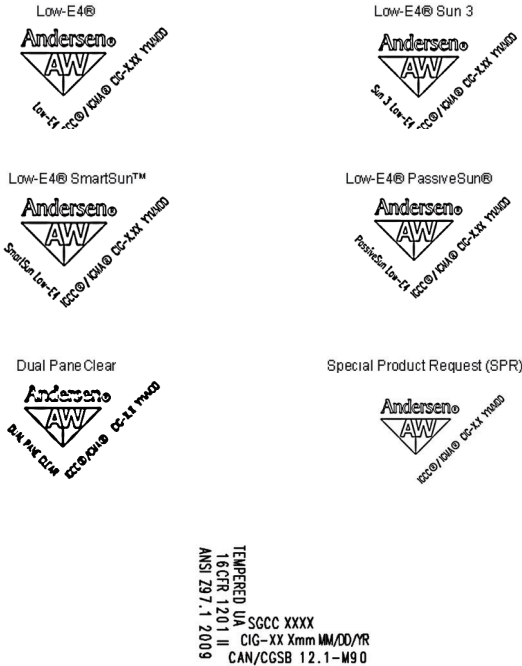

**Exterior color options:**  
**Interior species/finish/color options:**  
**Glass options (See Logo/Etching Examples):**

Low-E4®	Low-E4® HeatLock	Low-E4® Triple-Pane
Low-E4® SmartSun™	Low-E4® Smart-Sun HeatLock	Low-E4® Smart-Sun Triple-Pane
Low-E4® Passive Sun	Low-E4® Sun Heat-Lock	Low-E4® Enhanced Triple-Pane
Low-E4® Sun 3	Low-E4® HeatLock Tempered	Low-E4® Smart-Sun Enhanced Triple-Pane
Low-E4® Tempered	Dual Pane Clear	Low-E4® Enhanced Triple-Pane Heat-Lock
Low-E4® SmartSun Tempered	Cascade	Low-E4® Smart-Sun Enhanced Triple-Pane HeatLock
Low-E4® Passive Sun Tempered	Fern	
Low-E4® Sun Tempered	Reed	

To order, state:

Product ID (from product label, see [Service Guide 9051877](#))

OR

1. Unit or frame size (CSLD XXXX or frame W x H dimensions)
2. Type (Double, Triple)
3. Unit sash ratio (Double - Standard, Special ; Triple - Standard,  $\frac{1}{4} - \frac{1}{2} - \frac{1}{4}$ ,  $\frac{1}{3} - \frac{1}{3} - \frac{1}{3}$ )
4. Description of part (Stationary Sash)
5. Exterior color of sash
6. Hardware finish of keeper
7. Interior wood species/finish/color of sash
8. Glazing/Grille type

### Double Sash Ratio

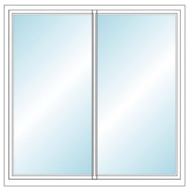

Standard

Special

### Triple Sash Ratio

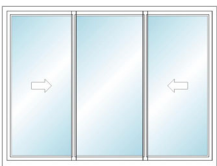

Standard (24" flanker)

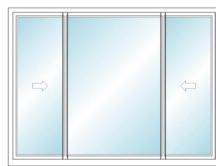

$\frac{1}{4} - \frac{1}{2} - \frac{1}{4}$

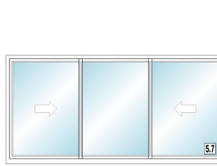

$\frac{1}{3} - \frac{1}{3} - \frac{1}{3}$

# E-Series Gliding Windows (May 2002 to 2013)

Standard Windows

## Sash

### Sash Parts

#### Block Pin

**Note:**

Used on bottom of stationary sash.

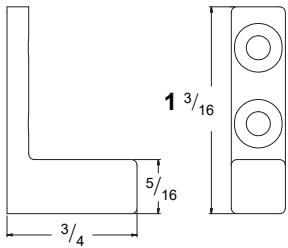

**Order No.**

0SL7022

#### Screw / Block Pin

	Description	Order No.
	#7 X 7/8 PFHSMS TYPE AB S.S.	0015746

## Sash

Sash Hardware / Lift (Pull)														
Sash Lift (Pull) / Traditional														
<b>Note:</b> See <a href="#">Service Guide 9069189</a> .														
		<table border="1"> <thead> <tr> <th>Color</th> <th>Order No.</th> </tr> </thead> <tbody> <tr> <td>White</td> <td>0SL1138</td> </tr> <tr> <td>Bronze</td> <td>0SL1137</td> </tr> <tr> <td>Brass</td> <td>N/A</td> </tr> <tr> <td>Black</td> <td>0SL1173</td> </tr> <tr> <td>Gold</td> <td>N/A</td> </tr> </tbody> </table>	Color	Order No.	White	0SL1138	Bronze	0SL1137	Brass	N/A	Black	0SL1173	Gold	N/A
	Color	Order No.												
	White	0SL1138												
	Bronze	0SL1137												
	Brass	N/A												
	Black	0SL1173												
Gold	N/A													

Screw / Sash Lift		
	Description	Order No.
	#7 X 1 1/4 PFHSMS TYPE AB S.S 18-8 S.S.	0027959

# E-Series Gliding Windows (May 2002 to 2013)

Standard Windows

## Sash

### Sash Hardware / Lock & Keeper

#### Lock

**Note:**

See [Service Guide 9069182](#).

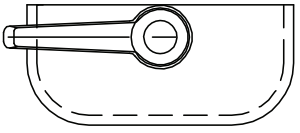
		<b>Color</b>	<b>Order No.</b>
		White	By description
		Bronze	By description
		Brass	0006000
		Black	0006008
		Gold	0006001
		Antique Brass	0228847
		Oil-Rubbed Bronze	0229891
		Satin Chrome	0607904

#### Lock Keeper

**Note:**

Security keeper shown. See [Service Guide 9069181](#) (standard keeper shown).

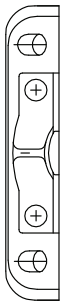
		<b>Color</b>	<b>Order No.</b>
		White	0008184
		Bronze	0008183
		Brass	0008000
		Black	0008008
		Gold	0008001
		Pewter	N/A
		Oil-Rubbed Bronze	0228984
		Satin Chrome	0607903
		Bright Chrome	N/A
		Antique Brass	0228846

#### Screw / Keeper

	<b>Description</b>	<b>Color</b>	<b>Order No.</b>
	#6 x 1 1/4" PFHSMS W#5 HD	Bronze	0002392
		Bronze	0002393
		Brass	0002394
		Black	0002395
		Gold	0002396
		Z & Y	0002397

## Sash

Sash Hardware / Roller		
Roller Assembly		
<b>Note:</b> See <a href="#">Service Guide 9069197</a> .		
		<b>Order No.</b> 0007245

Screw / Roller Assembly		
	Description	Order No.
	#4 X 1/2 PFHSMS TYPE AB S.S. 18-8 STAINLESS STEEL	0009884



Glass

**Glass**

**Glass**

**Note:**  
Replacement glass is made to order and can be configured through iQ. Current glazings replace previous vintage glazings. Product ID label is located on the head jamb. Glass ships with sealant and spacers. See [Accessory Guide 9176386](#).

TEMPERED UA  
16 CFR 1201 II  
ANSI Z97.1-2009  
SGCC XXXX  
CIG-XX Xmm MM/DD/YR  
CAN/CGSB 12.1-M90

**Exterior color options:**  
**Interior species/finish/color options:**  
**Glass options (See Logo/Etching Examples):**

Low-E4®	Low-E4® HeatLock	Low-E4® SmartSun HeatLock
Low-E4® SmartSun™	Low-E4® Smart-Sun HeatLock	Low-E4® Triple-Pane
Low-E4® Passive Sun	Low-E4® Sun Heat-Lock	Low-E4® Smart-Sun Triple-Pane
Low-E4® Sun 3	Low-E4® HeatLock Tempered	Low-E4® Enhanced Triple-Pane
Low-E4® Tempered	Dual Pane Clear	Low-E4® Smart-Sun Enhanced Triple-Pane
Low-E4® SmartSun Tempered	Cascade	Low-E4® Enhanced Triple-Pane Heat-Lock
Low-E4® Passive Sun Tempered	Fern	Low-E4® Smart-Sun Enhanced Triple-Pane HeatLock
Low-E4® Sun Tempered	Reed	

*To order, state:*  
**Product ID (from product label, see [Service Guide 9051877](#))**  
**OR**

- Unit or frame size (CSLD XXXX or frame W x H dimensions)
- Description of part (Glass)
- Glazing/Grille type
- Glass Stop Type (Ovolo, Coped)
- Manufacturing Date

# Glass

## Glass Stops

### Stops - Top / Bottom / Side

**Note:**

Stops (top, bottom and side) are made to order.

To order, state:

Product ID (from product label, see [Service Guide 9051877](#))

OR

1. Description of Part/Size (Stop)
2. Color/Species/Finish
3. Location/Handing (Top, Bottom, Side)
4. Type (Ovolo, Coped)
5. Manufacturing Date

**Ovolo**

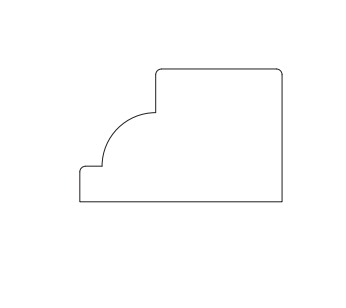

**Coped**

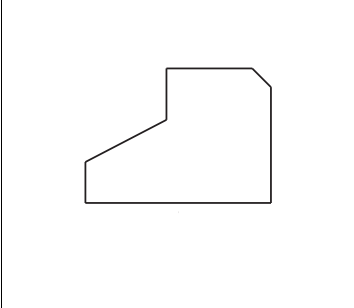

**Interior species/finish/color options**

**WOOD SPECIES**

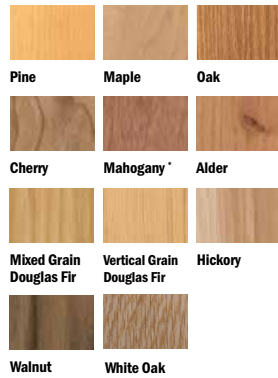

**FACTORY-FINISHED INTERIORS**



**PAINTED OPTIONS**



# E-Series Gliding Windows (May 2002 to 2013)

Standard Windows

## Glass

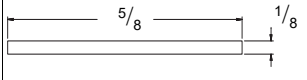
<b>Glass Parts</b>			
<b>Glazing Tape</b>			
		<b>Color</b>	<b>Order No.</b>
		Gray	33751RL
		Black	10374RL
<b>Silicone Bed Glazing</b>			
		<b>Color</b>	<b>Order No.</b>
		Dove Gray	9164412
<b>Spacer</b>			
		<b>Order No.</b>	
		9152146	

## Insect Screens

### Insect Screen Graphic - Full

**Note:**

Replacement screen is made to order and can be configured through iQ. Full screens are not used on three panel units.



Fiberglass



Aluminum



TruScene

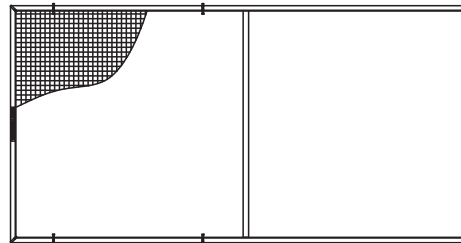

**Note:**

Multiple screen options available.

**Color options:**

**Mesh options:** See iQ

*To order, state:*

1. **Description of Part (Full Insect Screen, color, mesh type)**
2. **Style (XO/OX)**
3. **Quantity**
4. **Product ID (from product label, see [Service Guide 9051877](#))**

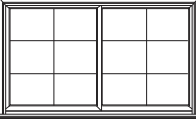
Insect Screen Size Table - Full		
Insect Screen Size Table - OX/XO Units		
Unit No.	Screen Dimensions (w x h)	
<b>30</b>	<b>SLD3020</b>	33 <sup>1</sup> / <sub>16</sub> x 21 <sup>15</sup> / <sub>16</sub>
	<b>SLD3030</b>	33 <sup>1</sup> / <sub>16</sub> x 33 <sup>15</sup> / <sub>16</sub>
<b>40</b>	<b>SLD4020</b>	45 <sup>1</sup> / <sub>16</sub> x 21 <sup>15</sup> / <sub>16</sub>
	<b>SLD4030</b>	45 <sup>1</sup> / <sub>16</sub> x 33 <sup>15</sup> / <sub>16</sub>
	<b>SLD4034</b>	45 <sup>1</sup> / <sub>16</sub> x 37 <sup>15</sup> / <sub>16</sub>
	<b>SLD4040</b>	45 <sup>1</sup> / <sub>16</sub> x 45 <sup>15</sup> / <sub>16</sub>
	<b>SLD4046</b>	45 <sup>1</sup> / <sub>16</sub> x 51 <sup>15</sup> / <sub>16</sub>
	<b>SLD4050</b>	45 <sup>1</sup> / <sub>16</sub> x 57 <sup>15</sup> / <sub>16</sub>
<b>50</b>	<b>SLD5020</b>	57 <sup>1</sup> / <sub>16</sub> x 21 <sup>15</sup> / <sub>16</sub>
	<b>SLD5030</b>	57 <sup>1</sup> / <sub>16</sub> x 33 <sup>15</sup> / <sub>16</sub>
	<b>SLD5034</b>	57 <sup>1</sup> / <sub>16</sub> x 37 <sup>15</sup> / <sub>16</sub>
	<b>SLD5040</b>	57 <sup>1</sup> / <sub>16</sub> x 45 <sup>15</sup> / <sub>16</sub>
	<b>SLD5046</b>	57 <sup>1</sup> / <sub>16</sub> x 51 <sup>15</sup> / <sub>16</sub>
	<b>SLD5050</b>	57 <sup>1</sup> / <sub>16</sub> x 57 <sup>15</sup> / <sub>16</sub>
<b>60</b>	<b>SLD6020</b>	69 <sup>1</sup> / <sub>16</sub> x 21 <sup>15</sup> / <sub>16</sub>
	<b>SLD6030</b>	69 <sup>1</sup> / <sub>16</sub> x 33 <sup>15</sup> / <sub>16</sub>
	<b>SLD6034</b>	69 <sup>1</sup> / <sub>16</sub> x 37 <sup>15</sup> / <sub>16</sub>
	<b>SLD6040</b>	69 <sup>1</sup> / <sub>16</sub> x 45 <sup>15</sup> / <sub>16</sub>
	<b>SLD6046</b>	69 <sup>1</sup> / <sub>16</sub> x 51 <sup>15</sup> / <sub>16</sub>
	<b>SLD6050</b>	69 <sup>1</sup> / <sub>16</sub> x 57 <sup>15</sup> / <sub>16</sub>

## Insect Screens

### Insect Screen Graphic - Half

**Note:**

Replacement screen is made to order and can be configured through iQ.



Fiberglass



Aluminum

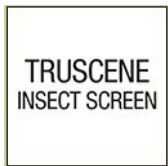

TruScene

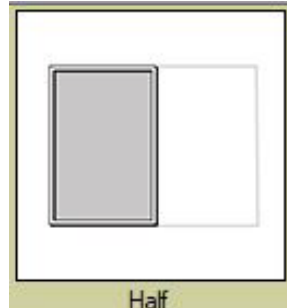

Half

**Note:**

Multiple screen options available.

**Color options:**

**Mesh options:** See iQ

*To order, state:*

1. Description of Part (Half Insect Screen, color, mesh type)
2. Style (XO/OX, XOX)
3. Quantity
4. Product ID (from product label, see [Service Guide 9051877](#))

### Insect Screen Size Table - Half

#### Insect Screen Size Table - OX/XO Units

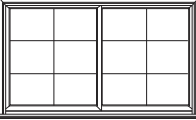
Unit No.		Screen Dimensions (w x h)	
<b>30</b>	<b>SLD3020</b>	16 <sup>1</sup> / <sub>16</sub> x 21 <sup>15</sup> / <sub>16</sub>	
	<b>SLD3030</b>	16 <sup>1</sup> / <sub>16</sub> x 33 <sup>15</sup> / <sub>16</sub>	
<b>40</b>	<b>SLD4020</b>	22 <sup>1</sup> / <sub>16</sub> x 21 <sup>15</sup> / <sub>16</sub>	
	<b>SLD4030</b>	22 <sup>1</sup> / <sub>16</sub> x 33 <sup>15</sup> / <sub>16</sub>	
	<b>SLD4034</b>	22 <sup>1</sup> / <sub>16</sub> x 37 <sup>15</sup> / <sub>16</sub>	
	<b>SLD4040</b>	22 <sup>1</sup> / <sub>16</sub> x 45 <sup>15</sup> / <sub>16</sub>	
	<b>SLD4046</b>	22 <sup>1</sup> / <sub>16</sub> x 51 <sup>15</sup> / <sub>16</sub>	
	<b>SLD4050</b>	22 <sup>1</sup> / <sub>16</sub> x 57 <sup>15</sup> / <sub>16</sub>	
<b>50</b>	<b>SLD5020</b>	28 <sup>1</sup> / <sub>16</sub> x 21 <sup>15</sup> / <sub>16</sub>	
	<b>SLD5030</b>	28 <sup>1</sup> / <sub>16</sub> x 33 <sup>15</sup> / <sub>16</sub>	
	<b>SLD5034</b>	28 <sup>1</sup> / <sub>16</sub> x 37 <sup>15</sup> / <sub>16</sub>	
	<b>SLD5040</b>	28 <sup>1</sup> / <sub>16</sub> x 45 <sup>15</sup> / <sub>16</sub>	
	<b>SLD5046</b>	28 <sup>1</sup> / <sub>16</sub> x 51 <sup>15</sup> / <sub>16</sub>	
	<b>SLD5050</b>	28 <sup>1</sup> / <sub>16</sub> x 57 <sup>15</sup> / <sub>16</sub>	
<b>60</b>	<b>SLD6020</b>	34 <sup>1</sup> / <sub>16</sub> x 21 <sup>15</sup> / <sub>16</sub>	
	<b>SLD6030</b>	34 <sup>1</sup> / <sub>16</sub> x 33 <sup>15</sup> / <sub>16</sub>	
	<b>SLD6034</b>	34 <sup>1</sup> / <sub>16</sub> x 37 <sup>15</sup> / <sub>16</sub>	
	<b>SLD6040</b>	34 <sup>1</sup> / <sub>16</sub> x 45 <sup>15</sup> / <sub>16</sub>	
	<b>SLD6046</b>	34 <sup>1</sup> / <sub>16</sub> x 51 <sup>15</sup> / <sub>16</sub>	
	<b>SLD6050</b>	34 <sup>1</sup> / <sub>16</sub> x 57 <sup>15</sup> / <sub>16</sub>	

## Insect Screens

**Insect Screen Size Table - XOX Units**

**Note:**

3-sash gliding units (XOX) use 2'0" operating sash as standard. Additional sash ratios also available.

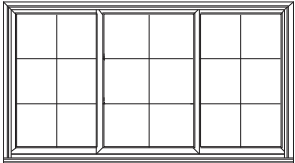
Unit No.		Sash Dimensions (w x h)	
<b>60</b>	<b>SLD6020</b>	22 1/8 x 21 15/16	
	<b>SLD6030</b>	22 1/8 x 33 15/16	
	<b>SLD6034</b>	22 1/8 x 37 15/16	
	<b>SLD6040</b>	22 1/8 x 45 15/16	
	<b>SLD6046</b>	22 1/8 x 51 15/16	
	<b>SLD6050</b>	22 1/8 x 57 15/16	
<b>80</b>	<b>SLD8020</b>	22 1/8 x 21 15/16	
	<b>SLD8030</b>	22 1/8 x 33 15/16	
	<b>SLD8034</b>	22 1/8 x 37 15/16	
	<b>SLD8040</b>	22 1/8 x 45 15/16	
	<b>SLD8046</b>	22 1/8 x 51 15/16	
	<b>SLD8050</b>	22 1/8 x 57 15/16	



# E-Series Gliding Windows (May 2002 to 2013)

Standard Windows

## Insect Screens

### Insect Screen Retainer

#### Insect Screen Retainer / Half Screen / 144"

**Note:**

(\*) Anodized finishes. See [color options](#). Cut to size.

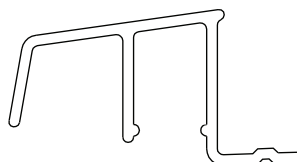

Color	2604	2605	Color	2604	2605
Colony White	0078200	00K9150	Moss	0078225	00K9190
White	0047052	0K14105	Forest Green		
Eagle Abalone	0078218	00K9174	Mallard Green	0078210	00K9160
Balsa White	0078205	00K9155	Spearmint	0066037	00K9183
Canvas	0011292	0K18155	Aquamarine	0066036	00K9182
Maple Syrup	0078220	00K9176	Patina	0066040	00K9189
Harvest Gold	0066034	00K9172	Sky Blue	0066029	00K9162
Prairie Grass	0011295	0K18158	Country Blue	0078208	00K9158
Flagstone	0078207	00K9157	Blue Denim	0078221	00K9177
Sandtone	0047050	0K14103	Watercolor Blue	0066031	00K9167
Pebble Tan	0078202	00K1356	Caribbean Blue	0066035	00K9180
Carmel	0078214	00K9166	Slate	0078222	00K9178
Terratone	0047051	0K14104	Moody Blue	0066030	00K9163
Hot Chocolate	0078223	00K9179	Stormy Blue	0078206	00K9156
Bourbon	0076686	00K9193	Dove Gray	0011293	0K18156
Acorn	0078227	00K9192	Harbor Mist	0078216	00K9171
Coffee Bean	0078229	00K9195	Yorktown Pewter	0066033	00K9170
Cocoa Bean	0011294	0K18157	Smokey Gray	0078226	00K9191
Dark Bronze	0049429	0K20924	Mystic Gray	0078232	00K9198
Clay Canyon	0078215	00K9168	Dark Ash	0078231	00K9197
Cardinal Red		00K9187	Black	0011291	0K18154
Bing Cherry		00K9186	Clear Anodized*		0075791
Fire Engine Red		00K1991	Champagne*		0075792
Cinnamon Toast	0078211	00K9161	Light Bronze*		0075793
Red Rock	0011296	0K18159	Medium Bronze*		0075794
Olive	0078209	00K9159	Copper*		
Sage	0078230	00K9196	Dark Bronze*		0075795
Billiard Green	0066032	00K9169	Black*		0075797

## Insect Screens

### Insect Screen Retainer

#### Insect Screen Retainer / Half Screen / 144"

**Note:**

(\*) Anodized finishes. See [color options](#). Cut to size.

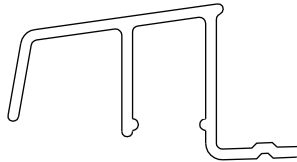

Color	2604	2605	Color	2604	2605
Eagle Black	0078219	00K9175			
Eagle Cappuccino	0078228	00K9194			
Bronze	0078201				
Eagle Linen	0078233	00K9152			
Eagle Blue Mist	0066038	00K9184			
Eagle Pink Chablis	0066039	00K9185			
Eagle Butterscotch	0078212	00K9164			
Eagle Elephant	0078224	00K9181			
Eagle Chocolate Chip	0078213	00K9165			
<b>Eagle Forest Green</b>	0078203	00K9153			
Antique White	0078204	00K9154			
Eagle Gray Flannel	0078217	00K9173			

### Insect Screen Parts

#### Screw

**Note:**

Used to secure half screen retainer.

	Description	Order No.
	#8 x 1/2" PPH TEKS #2 Zinc	0013441

## Grilles

### Grilles

**Note:**

Replacement sash with permanently applied grilles and finelight grilles can be configured in iQ. Replacement removable interior grilles can be configured in iQ. Removable grilles are only available in 7/8" profile.

**Exterior color/finish options**



**ANNODIZED FINISHES**

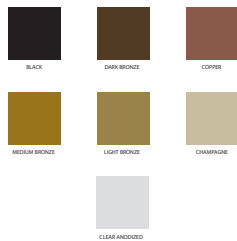

**Interior species/finish/color options**

**WOOD SPECIES**

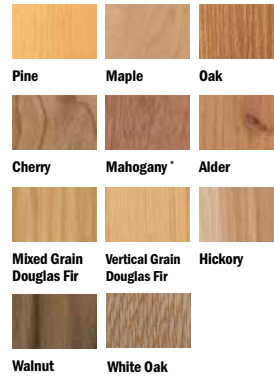

**FACTORY-FINISHED INTERIORS**

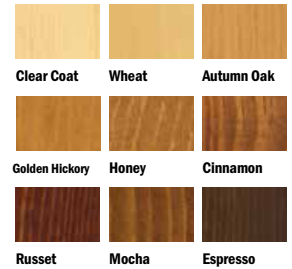

**PAINTED OPTIONS**



Painted options available with pine and maple only.

## Grilles

### Grille Options

**Note:**

Replacement sash with permanently applied grilles and finelight grilles can be configured in iQ. Replacement removable interior grilles can be configured in iQ. Removable grilles are only available in 7/8" profile.

### Types



**Full Divided Light**

Give any window an authentic look with full divided light grilles that are permanently applied to the interior and exterior of your window with a spacer between the glass.



**Simulated Divided Light**

An economical solution with traditional beauty, our Simulated Divided Light features fixed exterior and interior grilles without an internal spacer.



**Removable Interior Wood Grilles**

Our removable wood grilles are installed on the interior surface. They are available with an optional surround and an optional permanently applied exterior grille.



**Finelight™ Grilles-Between-the-Glass**

Aluminum grilles conveniently placed between two panes of glass make the glass easy to clean inside and out.

### Profiles

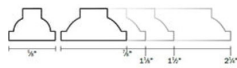

**Interior Wood:**  
Ovolo (Colonial)

Widths:

- 5/8"
- 7/8"
- 1 1/8"
- 1 1/2"
- 2 1/4"

Available with:

- Full Divided Light
- Simulated Divided Light



**Exterior Aluminum:**  
Chamfer

Widths:

- 5/8"
- 7/8"
- 1 1/8"
- 1 1/2"
- 2 1/4"

Available with:

- Full Divided Light
- Simulated Divided Light
- Removable Interior Wood with Optional Permanently Applied Exterior Grille

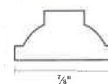

**Removable Interior Wood Grilles**

Ovolo profile in 7/8" width

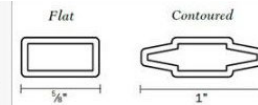

**Finelight Grille Profiles and Widths**

Flat or Contoured profiles in 5/8" or 1" widths

### Patterns

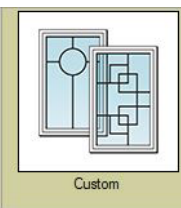
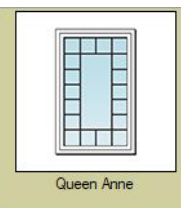
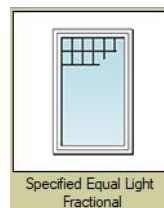
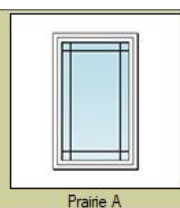
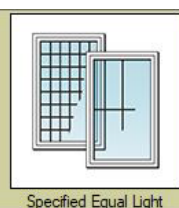
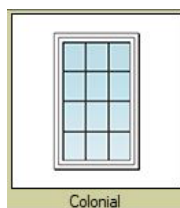

## Grilles

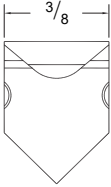
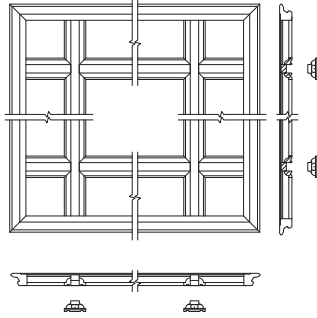
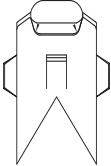
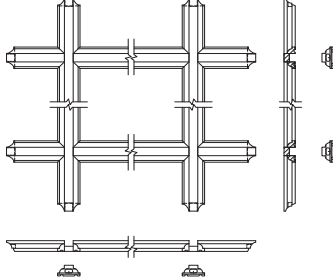
<b>Interior Grille Parts</b>		
<b>Clip - Surround</b>		
<b>Note:</b> Used with framed removable grilles.		
		<b>Order No.</b> 0004900
<b>Clip - Knocked Down</b>		
<b>Note:</b> Used with knocked down removable grilles.		
		<b>Order No.</b> 0004901

## Frames

### Frame Graphic - Vertical / Horizontal

**Note:**

See current frame [Product Details](#).

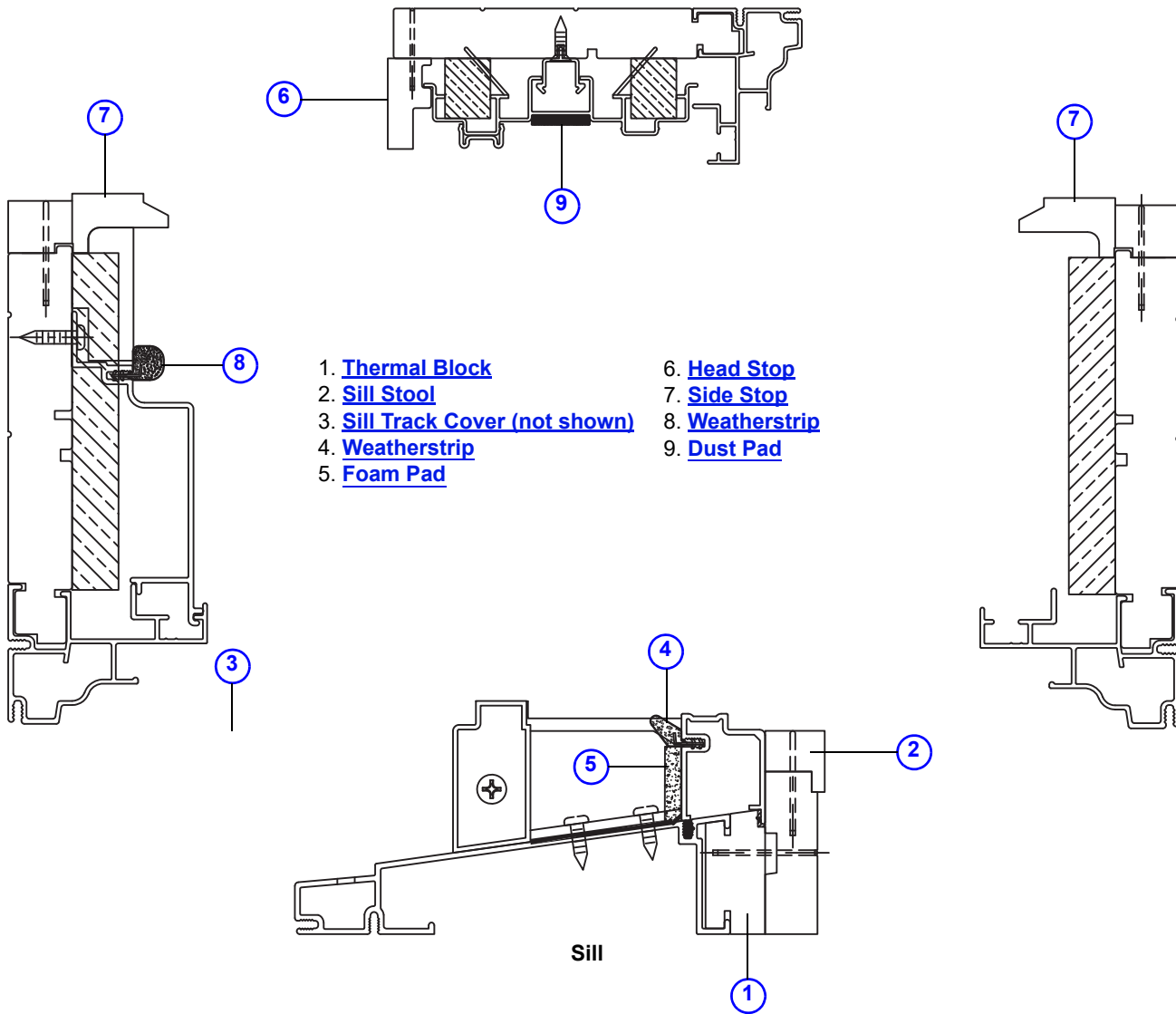

- |   |                                 |
|---|---------------------------------|
| 1. <a href="#">Thermal Block</a>                | 6. <a href="#">Head Stop</a>    |
| 2. <a href="#">Sill Stool</a>                   | 7. <a href="#">Side Stop</a>    |
| 3. <a href="#">Sill Track Cover (not shown)</a> | 8. <a href="#">Weatherstrip</a> |
| 4. <a href="#">Weatherstrip</a>                 | 9. <a href="#">Dust Pad</a>     |
| 5. <a href="#">Foam Pad</a>                     |                                 |

**E-Series Gliding Windows Frame Assembly**

### Frame Graphic - Top/Bottom View

Note:

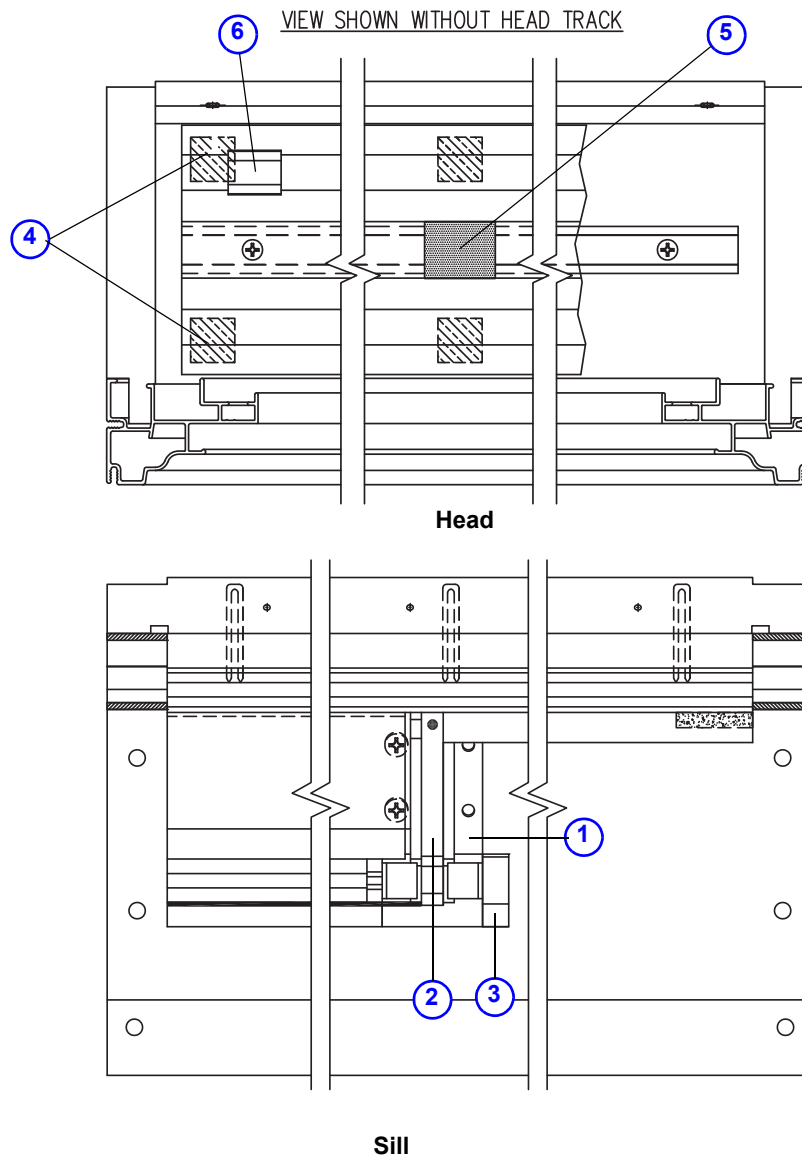

1. [Sill Track Block](#)
2. [Foam Sill Seal](#)
3. [Sill Block Cover](#)
4. [Foam Pad \(Head\)](#)
5. [Dust Pad](#)
6. [Sash Stop \(Head\)](#)

### E-Series Gliding Windows Frame Assembly

# Frames

## Frame

**Note:**

Available as configured through iQ.

To order, state:

Product ID (from product label, see [Service Guide 9051877](#))

OR

1. Description of Part/Size (CSLD XXXX or frame W X H dimensions)
2. Colors/Species/Finish
3. Manufacturing Date

### Exterior color/finish options



### ANNODIZED FINISHES



### Interior species/finish/color options

#### WOOD SPECIES

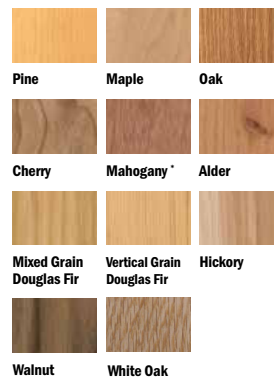

#### FACTORY-FINISHED INTERIORS



#### PAINTED OPTIONS





### Stops

#### Stops / Blocks / Stools - Head / Sill / Side

**Note:**

Stops (head, head parting, side and sill) are made to order.

To order, state:

Product ID (from product label, see [Service Guide 9051877](#))

OR

1. Description of Part/Size (Stop/Block/Stool)
2. Color/Species/Finish
3. Location/Handing (Head, Sill, Side)
4. Manufacturing Date

#### Interior species/finish/color options

##### WOOD SPECIES

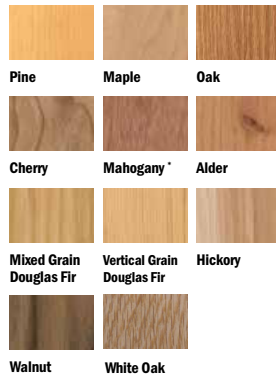

##### FACTORY-FINISHED INTERIORS



##### PAINTED OPTIONS



## Frames

### Weatherstrip

Weatherstrip Ref. No. 4 [page 32](#)

**Note:**

See [Service Guide 9069183](#).

		Length	Color	Order No.
		8 ft (96")	Tan	9183924

### Weatherstrip - Frame / Side Jamb Ref. 8 [page 32](#)

**Note:**



See [Service Guide 9069180](#).

		Length	Color	Order No.
		72"	White	9096436
			Beige	9096435

# E-Series Gliding Windows (May 2002 to 2013)

Standard Windows

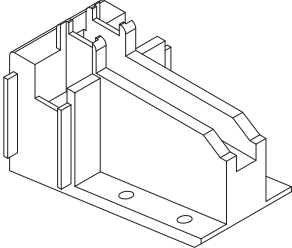
## Frames

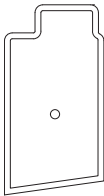
Frame Parts			
Block / Sill Track			
		Finish	Order No.
		Bronze	0002939
		Green	0002940
		White	0009245
		Tan	0009246
		Black	0046398
Foam Seal / Sill			
			Order No.
			0SL5519
Cover / Sill Block			
		Finish	Order No.
		Bronze	0002937
		Green	0002938
		White	0008208
		Tan	0008209
		Black	0046399
Cover / Sill Track			
	<p><b>Note:</b> Sill track cover is made to order.</p> <p><i>To order, state:</i></p> <ol style="list-style-type: none"> <li><b>Description of Part (Cover - Sill Track)</b></li> <li><b>Quantity</b></li> <li><b>Size</b></li> <li><b>Color (Beige, White)</b></li> </ol>		
Foam Pad / Sill			
			Order No.
			0075244
Foam Plug / Head			
			Order No.
			0038252

## Frames

Dust Pad / Head	
	<b>Order No.</b> 0JB7007

Sash Stop / Head				
		Color	Size	Order No.
		White	3/4"	0007175
			3"	9105331
		Beige	3/4"	0007174
			3"	9105330

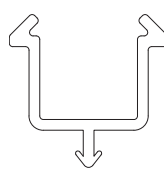
Head Track			
		Color	Order No.
		White	By description
		Beige	By description