

<b>What's in This Section</b>
-------------------------------

<b>Standard Windows</b> .....	<b>Page 3</b>
<b>Parts Illustration</b> .....	<b>3</b>
Parts Illustration .....	3
Colors - Exterior .....	4
Colors/Species/Finishes - Interior .....	5
<b>Unit Sizes</b> .....	<b>6</b>
Standard and Custom Window Sizes .....	6
E Series Product Label .....	6
Unit Size Chart - Standard Windows .....	7
<b>Product History</b> .....	<b>8</b>
Product History .....	8
<b>Sash</b> .....	<b>9</b>
Sash Size Table .....	9
Sash Graphic - Operating .....	11
Sash Options - Operating .....	12
Sash Graphic - Stationary .....	13
Sash Options - Stationary .....	14
Weatherstrip .....	15
Sash Parts .....	15
Sash Hardware / Lift (Pull) .....	16
Sash Hardware / Lock & Keeper .....	17
Sash Hardware / Roller .....	19
<b>Glass</b> .....	<b>20</b>
Glass .....	20
Glass Stops .....	21
Glass Parts .....	22
<b>Insect Screens</b> .....	<b>23</b>
Insect Screen Graphic - Full .....	23
Insect Screen Size Table - Full .....	24
Insect Screen Graphic - Half .....	25
Insect Screen Size Table - Half .....	26
Insect Screen Retainer .....	28
Insect Screen Parts .....	29
<b>Grilles</b> .....	<b>30</b>
Grilles .....	30
Grille Options .....	31
Interior Grille Parts .....	32

<b>Frames</b> .....	<b>33</b>
Frame Graphic - Vertical / Horizontal .....	33
Frame Graphic - Top View .....	34
Frame .....	35
Stops .....	36
Weatherstrip .....	37
Frame Parts .....	38
Extension Jambs .....	40
Casing .....	41
<b>Joining Components</b> .....	<b>42</b>
Joining Components .....	42



# E-Series Gliding Windows (2014 to Present)

Standard Windows

Parts Illustration

## Parts Illustration

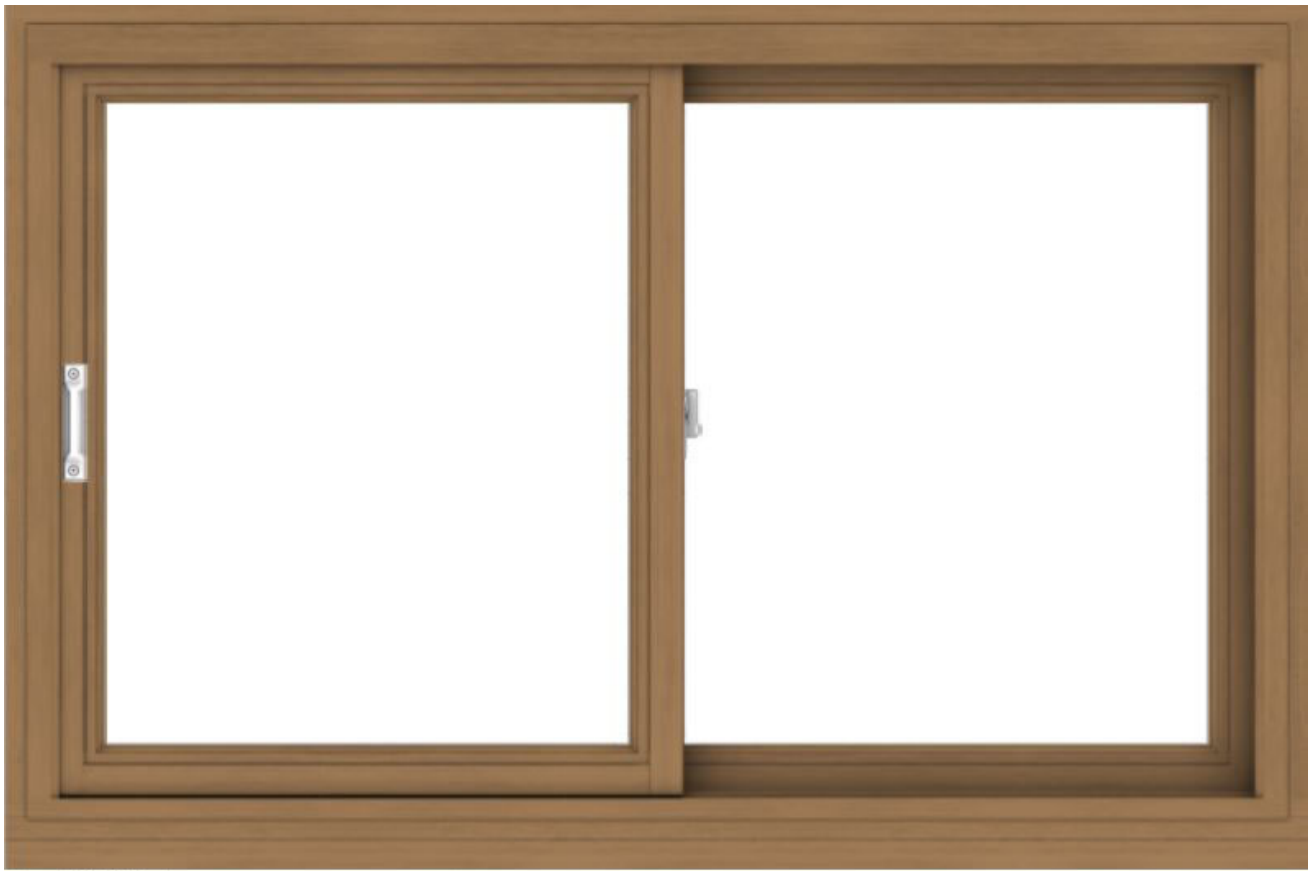

**E-Series Gliding Window Unit Parts**

*Unit viewed from interior*

## Parts Illustration

### Colors - Exterior

**Note:**  
(\*) Anodized Finishes

				Colony White	White	Abalone	Balsa White
			Canvas	Maple Syrup	Harvest Gold	Prairie Grass	
Flagstone	Sandtone	Pebble Tan	Carmel	Terratone	Hot Chocolate	Bourbon	
Acorn	Coffee Bean	Cocoa Bean	Sierra Bronze	Dark Bronze	Clay Canyon	Red Rock	
Cardinal	Bing Cherry	Fire Engine Red	Cinnamon Toast	Olive	Sage	Billiard Green	
Moss	Forest Green	Mallard Green	Spearmint	Aquamarine	Patina	Sky Blue	
Country Blue	Blue Denim	Watercolor Blue	Caribbean Blue	Slate	Moody Blue	Stormy Blue	
Dove Gray	Harbor Mist	Yorktown Pewter	Smokey Gray	Mystic Gray	Dark Ash	Black	
Light Bronze*	Champagne*	Clear Anodized*	Black	Dark Bronze*	Copper*	Medium Bronze*	

Colors/Species/Finishes - Interior

Species Interior Options



Pine



Mixed Grain  
Douglas Fir



Oak



Maple



Walnut



Alder



Hickory



Mahogany



Vertical Grain  
Douglas Fir



Cherry



White Oak

Stained Interior Options



Clear Coat



Wheat



Autumn Oak



Golden Hickory



Honey



Cinnamon

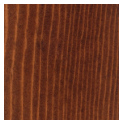

Russet



Mocha



Espresso

Painted Interior Options

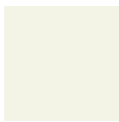

White

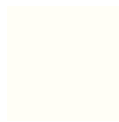

Birch Bark



Primed

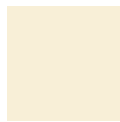

Canvas



Sandtone



Terratone



Forest Green



Dark Bronze



Dove Gray



Prairie Grass



Red Rock



Cocoa Bean



Black



Anodized Silver <sup>1</sup>

## Unit Sizes

---

### Standard and Custom Window Sizes

**Note:**

E-Series Gliding Windows are available in standard sizes (see standard size charts, [page 7](#)). Replacement parts for some standard windows can be ordered using the numbers listed in this catalog. Many replacement parts for standard windows are made to order. These items are ordered using the Product ID found on the identification label and a description of the part needed. See [Service Guide 9051877](#).

E-Series Gliding Windows are also available in custom sizes in 1/8" increments between the smallest and the largest standard sizes. Most replacement parts for custom-sized windows are made to order and can be ordered with the Product ID found on the identification label and a description of the part needed. See [Service Guide 9051877](#).

### E Series Product Label

**Note:**

Every E-Series Gliding Windows will have an identification label or glass etching containing a unique Product ID. The Product ID on E-Series Gliding Window will be located at the top of the window frame or etched into the glass. See [Service Guide 9051877](#). The Product ID may be up to 14 digits long (excluding hyphens), depending on the age of the unit. Replacement parts will also get their own unique Product ID. When ordering replacement parts, providing the Product ID ensures that replacement parts match the specifications.

# E-Series Gliding Windows (2014 to Present)

Standard Windows

## Unit Sizes

### Unit Size Chart - Standard Windows

**Note:**

Unit Dimension refers to overall outside-to-outside frame. V.G. refers to visible glass dimensions. See current unit [Size Details](#).

#### 2-Sash Gliding Window Sizes

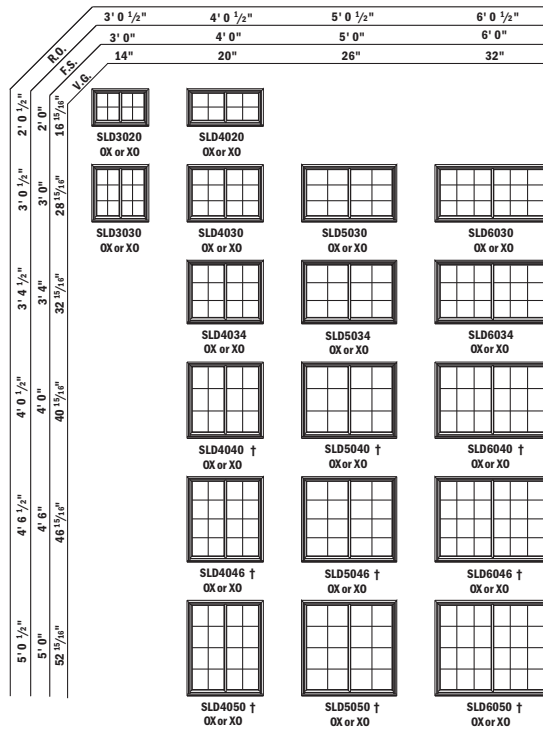

#### 3-Sash Gliding Window Sizes

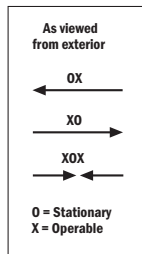
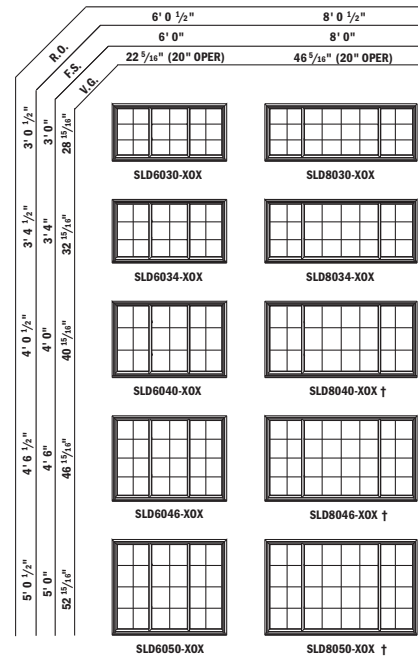

**NOTES**

† These units meet or exceed the following dimensions: Clear Opening Area 5.7 sq. ft., Clear Opening Height 24" and 44" maximum floor to sill height (with standard 6' 10-1/2" structural header height). See your local code official for requirements in your area.

3-sash gliding units use 2'0" operating sash as a standard. Additional sash ratios also available.

The light patterns illustrated apply to rectangular removable interior wood grilles. Full Divided Light, Simulated Divided Light, Decorelle 100, 150 and 400 and Finelight™ Grilles-Between-the-Glass. All removable interior wood grilles will be installed in the units unless otherwise specified.

For a metric conversion in millimeters, multiply dimensions in inches by 25.4

## Product History

---

### Product History

- 2022** White Oak introduced
- 2022** Stormwatch® (not shown in catalog) discontinued. See [Bulletin 80-21](#) for more detail.

# E-Series Gliding Windows (2014 to Present)

Standard Windows

## Sash

### Sash Size Table

**Note:**

Overall Sash is measured outside edge to outside edge of sash frame.

### Sash Size Table - OX/XO Units

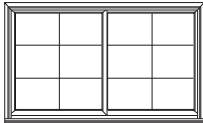
Unit No.		Sash Dimensions Operating Sash (w x h)	Sash Dimensions Stationary Sash (w x h)	Visible Glass Dimensions (w x h)	Graphic
<b>30</b>	<b>SLD3020</b>	17 <sup>5</sup> / <sub>16</sub> x 20 <sup>3</sup> / <sub>16</sub>	17 <sup>1</sup> / <sub>4</sub> x 20 <sup>3</sup> / <sub>16</sub>	14 x 16 <sup>15</sup> / <sub>16</sub>	
	<b>SLD3030</b>	17 <sup>5</sup> / <sub>16</sub> x 32 <sup>3</sup> / <sub>16</sub>	17 <sup>1</sup> / <sub>4</sub> x 32 <sup>3</sup> / <sub>16</sub>	14 x 28 <sup>15</sup> / <sub>16</sub>	
<b>40</b>	<b>SLD4020</b>	23 <sup>5</sup> / <sub>16</sub> x 20 <sup>3</sup> / <sub>16</sub>	23 <sup>1</sup> / <sub>4</sub> x 20 <sup>3</sup> / <sub>16</sub>	20 x 16 <sup>15</sup> / <sub>16</sub>	
	<b>SLD4030</b>	23 <sup>5</sup> / <sub>16</sub> x 32 <sup>3</sup> / <sub>16</sub>	23 <sup>1</sup> / <sub>4</sub> x 32 <sup>3</sup> / <sub>16</sub>	20 x 28 <sup>15</sup> / <sub>16</sub>	
	<b>SLD4034</b>	23 <sup>5</sup> / <sub>16</sub> x 36 <sup>3</sup> / <sub>16</sub>	23 <sup>1</sup> / <sub>4</sub> x 36 <sup>3</sup> / <sub>16</sub>	20 x 32 <sup>15</sup> / <sub>16</sub>	
	<b>SLD4040</b>	23 <sup>5</sup> / <sub>16</sub> x 44 <sup>3</sup> / <sub>16</sub>	23 <sup>1</sup> / <sub>4</sub> x 44 <sup>3</sup> / <sub>16</sub>	20 x 40 <sup>15</sup> / <sub>16</sub>	
	<b>SLD4046</b>	23 <sup>5</sup> / <sub>16</sub> x 50 <sup>3</sup> / <sub>16</sub>	23 <sup>1</sup> / <sub>4</sub> x 50 <sup>3</sup> / <sub>16</sub>	20 x 46 <sup>15</sup> / <sub>16</sub>	
	<b>SLD4050</b>	23 <sup>5</sup> / <sub>16</sub> x 56 <sup>3</sup> / <sub>16</sub>	23 <sup>1</sup> / <sub>4</sub> x 56 <sup>3</sup> / <sub>16</sub>	20 x 52 <sup>15</sup> / <sub>16</sub>	
<b>50</b>	<b>SLD5020</b>	29 <sup>5</sup> / <sub>16</sub> x 20 <sup>3</sup> / <sub>16</sub>	29 <sup>1</sup> / <sub>4</sub> x 20 <sup>3</sup> / <sub>16</sub>	26 x 16 <sup>15</sup> / <sub>16</sub>	
	<b>SLD5030</b>	29 <sup>5</sup> / <sub>16</sub> x 32 <sup>3</sup> / <sub>16</sub>	29 <sup>1</sup> / <sub>4</sub> x 32 <sup>3</sup> / <sub>16</sub>	26 x 28 <sup>15</sup> / <sub>16</sub>	
	<b>SLD5034</b>	29 <sup>5</sup> / <sub>16</sub> x 36 <sup>3</sup> / <sub>16</sub>	29 <sup>1</sup> / <sub>4</sub> x 36 <sup>3</sup> / <sub>16</sub>	26 x 32 <sup>15</sup> / <sub>16</sub>	
	<b>SLD5040</b>	29 <sup>5</sup> / <sub>16</sub> x 44 <sup>3</sup> / <sub>16</sub>	29 <sup>1</sup> / <sub>4</sub> x 44 <sup>3</sup> / <sub>16</sub>	26 x 40 <sup>15</sup> / <sub>16</sub>	
	<b>SLD5046</b>	29 <sup>5</sup> / <sub>16</sub> x 50 <sup>3</sup> / <sub>16</sub>	29 <sup>1</sup> / <sub>4</sub> x 50 <sup>3</sup> / <sub>16</sub>	26 x 46 <sup>15</sup> / <sub>16</sub>	
	<b>SLD5050</b>	29 <sup>5</sup> / <sub>16</sub> x 56 <sup>3</sup> / <sub>16</sub>	29 <sup>1</sup> / <sub>4</sub> x 56 <sup>3</sup> / <sub>16</sub>	26 x 52 <sup>15</sup> / <sub>16</sub>	
<b>60</b>	<b>SLD6020</b>	35 <sup>5</sup> / <sub>16</sub> x 20 <sup>3</sup> / <sub>16</sub>	35 <sup>1</sup> / <sub>4</sub> x 20 <sup>3</sup> / <sub>16</sub>	32 x 16 <sup>15</sup> / <sub>16</sub>	
	<b>SLD6030</b>	35 <sup>5</sup> / <sub>16</sub> x 32 <sup>3</sup> / <sub>16</sub>	35 <sup>1</sup> / <sub>4</sub> x 32 <sup>3</sup> / <sub>16</sub>	32 x 28 <sup>15</sup> / <sub>16</sub>	
	<b>SLD6034</b>	35 <sup>5</sup> / <sub>16</sub> x 36 <sup>3</sup> / <sub>16</sub>	35 <sup>1</sup> / <sub>4</sub> x 36 <sup>3</sup> / <sub>16</sub>	32 x 32 <sup>15</sup> / <sub>16</sub>	
	<b>SLD6040</b>	35 <sup>5</sup> / <sub>16</sub> x 44 <sup>3</sup> / <sub>16</sub>	35 <sup>1</sup> / <sub>4</sub> x 44 <sup>3</sup> / <sub>16</sub>	32 x 40 <sup>15</sup> / <sub>16</sub>	
	<b>SLD6046</b>	35 <sup>5</sup> / <sub>16</sub> x 50 <sup>3</sup> / <sub>16</sub>	35 <sup>1</sup> / <sub>4</sub> x 50 <sup>3</sup> / <sub>16</sub>	32 x 46 <sup>15</sup> / <sub>16</sub>	
	<b>SLD6050</b>	35 <sup>5</sup> / <sub>16</sub> x 56 <sup>3</sup> / <sub>16</sub>	35 <sup>1</sup> / <sub>4</sub> x 56 <sup>3</sup> / <sub>16</sub>	32 x 52 <sup>15</sup> / <sub>16</sub>	

## Sash

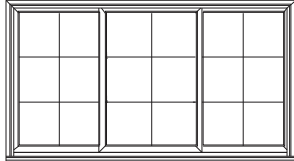
<b>Sash Size Table - XOX Units</b>				
<b>Note:</b> 3-sash gliding units (XOX) use 2'0" operating sash as standard. Additional sash ratios also available.				
<b>Unit No.</b>	<b>Sash Dimensions Fixed Sash (w x h)</b>	<b>Visible Glass Dimensions (w x h)</b>	<b>Graphic</b>	
<b>60</b>	<b>SLD6020</b>	25 <sup>9</sup> / <sub>16</sub> x 20 <sup>3</sup> / <sub>16</sub>	22 <sup>5</sup> / <sub>16</sub> x 16 <sup>15</sup> / <sub>16</sub>	
	<b>SLD6030</b>	25 <sup>9</sup> / <sub>16</sub> x 32 <sup>3</sup> / <sub>16</sub>	22 <sup>5</sup> / <sub>16</sub> x 28 <sup>15</sup> / <sub>16</sub>	
	<b>SLD6034</b>	25 <sup>9</sup> / <sub>16</sub> x 36 <sup>3</sup> / <sub>16</sub>	22 <sup>5</sup> / <sub>16</sub> x 32 <sup>15</sup> / <sub>16</sub>	
	<b>SLD6040</b>	25 <sup>9</sup> / <sub>16</sub> x 44 <sup>3</sup> / <sub>16</sub>	22 <sup>5</sup> / <sub>16</sub> x 40 <sup>15</sup> / <sub>16</sub>	
	<b>SLD6046</b>	25 <sup>9</sup> / <sub>16</sub> x 50 <sup>3</sup> / <sub>16</sub>	22 <sup>5</sup> / <sub>16</sub> x 46 <sup>15</sup> / <sub>16</sub>	
	<b>SLD6050</b>	25 <sup>9</sup> / <sub>16</sub> x 56 <sup>3</sup> / <sub>16</sub>	22 <sup>5</sup> / <sub>16</sub> x 52 <sup>15</sup> / <sub>16</sub>	
<b>80</b>	<b>SLD8020</b>	49 <sup>9</sup> / <sub>16</sub> x 20 <sup>3</sup> / <sub>16</sub>	46 <sup>5</sup> / <sub>16</sub> x 16 <sup>15</sup> / <sub>16</sub>	
	<b>SLD8030</b>	49 <sup>9</sup> / <sub>16</sub> x 32 <sup>3</sup> / <sub>16</sub>	46 <sup>5</sup> / <sub>16</sub> x 28 <sup>15</sup> / <sub>16</sub>	
	<b>SLD8034</b>	49 <sup>9</sup> / <sub>16</sub> x 36 <sup>3</sup> / <sub>16</sub>	46 <sup>5</sup> / <sub>16</sub> x 32 <sup>15</sup> / <sub>16</sub>	
	<b>SLD8040</b>	49 <sup>9</sup> / <sub>16</sub> x 44 <sup>3</sup> / <sub>16</sub>	46 <sup>5</sup> / <sub>16</sub> x 40 <sup>15</sup> / <sub>16</sub>	
	<b>SLD8046</b>	49 <sup>9</sup> / <sub>16</sub> x 50 <sup>3</sup> / <sub>16</sub>	46 <sup>5</sup> / <sub>16</sub> x 46 <sup>15</sup> / <sub>16</sub>	
	<b>SLD8050</b>	49 <sup>9</sup> / <sub>16</sub> x 56 <sup>3</sup> / <sub>16</sub>	46 <sup>5</sup> / <sub>16</sub> x 52 <sup>15</sup> / <sub>16</sub>	



### Sash Graphic - Operating

**Note:**

See current sash [Product Details](#).

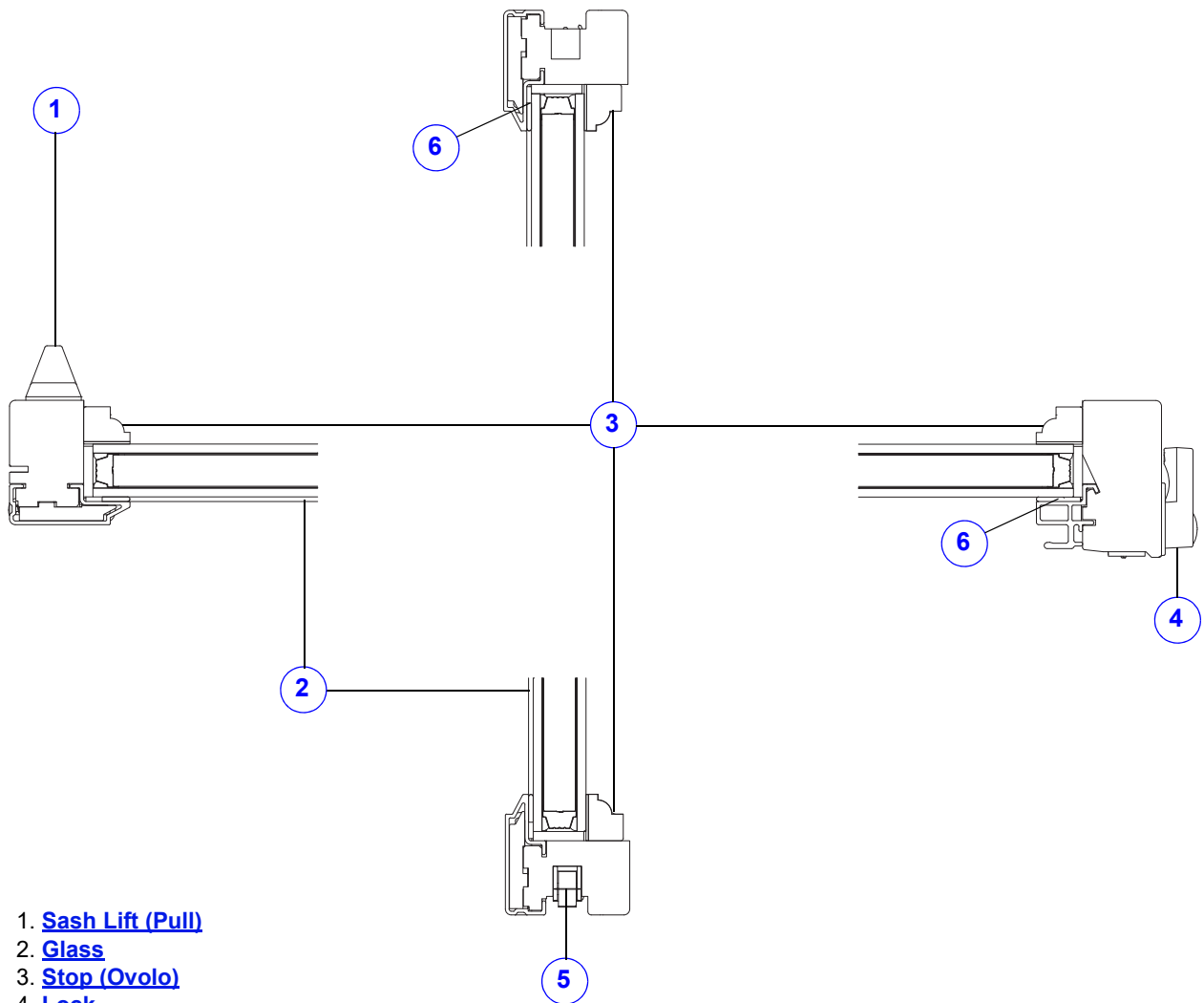

- 1. [Sash Lift \(Pull\)](#)
- 2. [Glass](#)
- 3. [Stop \(Ovolo\)](#)
- 4. [Lock](#)
- 5. [Roller](#)
- 6. [Spacer](#)

**E-Series Gliding Window Sash - Operating**

# Sash

## Sash Options - Operating

### Sash - Standard Window

**Note:**

Replacement glass is made to order and can be configured through iQ+. Current glazings replace previous vintage glazings. Product ID label is located on the head jamb. See [Service Guide 9069179](#) for sash replacement instructions.

for

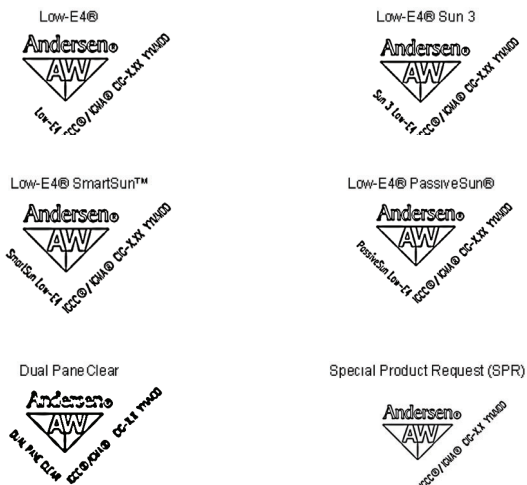

TEMPERED  
 UN SCCC XXXX  
 16 CFR 1201 II  
 ANSI Z97.1-2009  
 CIG-XX Xmm MM/DD/YR  
 CAN/CGSB 12.1-M90

**Exterior color options:**  
**Interior species/finish/color options:**  
**Glass options (See Logo/Etching Examples):**

Low-E4®	Low-E4® HeatLock	Low-E4® Triple-Pane
Low-E4® SmartSun™	Low-E4® Smart-Sun HeatLock	Low-E4® Smart-Sun Triple-Pane
Low-E4® Passive Sun	Low-E4® Sun Heat-Lock	Low-E4® Enhanced Triple-Pane
Low-E4® Sun 3	Low-E4® HeatLock Tempered	Low-E4® Smart-Sun Enhanced Triple-Pane
Low-E4® Tempered	Dual Pane Clear	Low-E4® Enhanced Triple-Pane Heat-Lock
Low-E4® SmartSun Tempered	Cascade	Low-E4® Smart-Sun Enhanced Triple-Pane HeatLock
Low-E4® Passive Sun Tempered	Fern	
Low-E4® Sun Tempered	Reed	

To order, state:

Product ID (from product label, see [Service Guide 9051877](#))

OR

1. Unit or frame size (CSLD XXXX or frame W x H dimensions)
2. Unit sash ratio (Even, Cottage, Rev Cottage, SSR)
3. Description of part (Upper Sash)
4. Exterior color of sash
5. Hardware finish of keeper
6. Interior wood species/finish/color of sash
7. Glazing/Grille type

### Sash Graphic - Stationary

**Note:**

See current sash [Product Details](#).

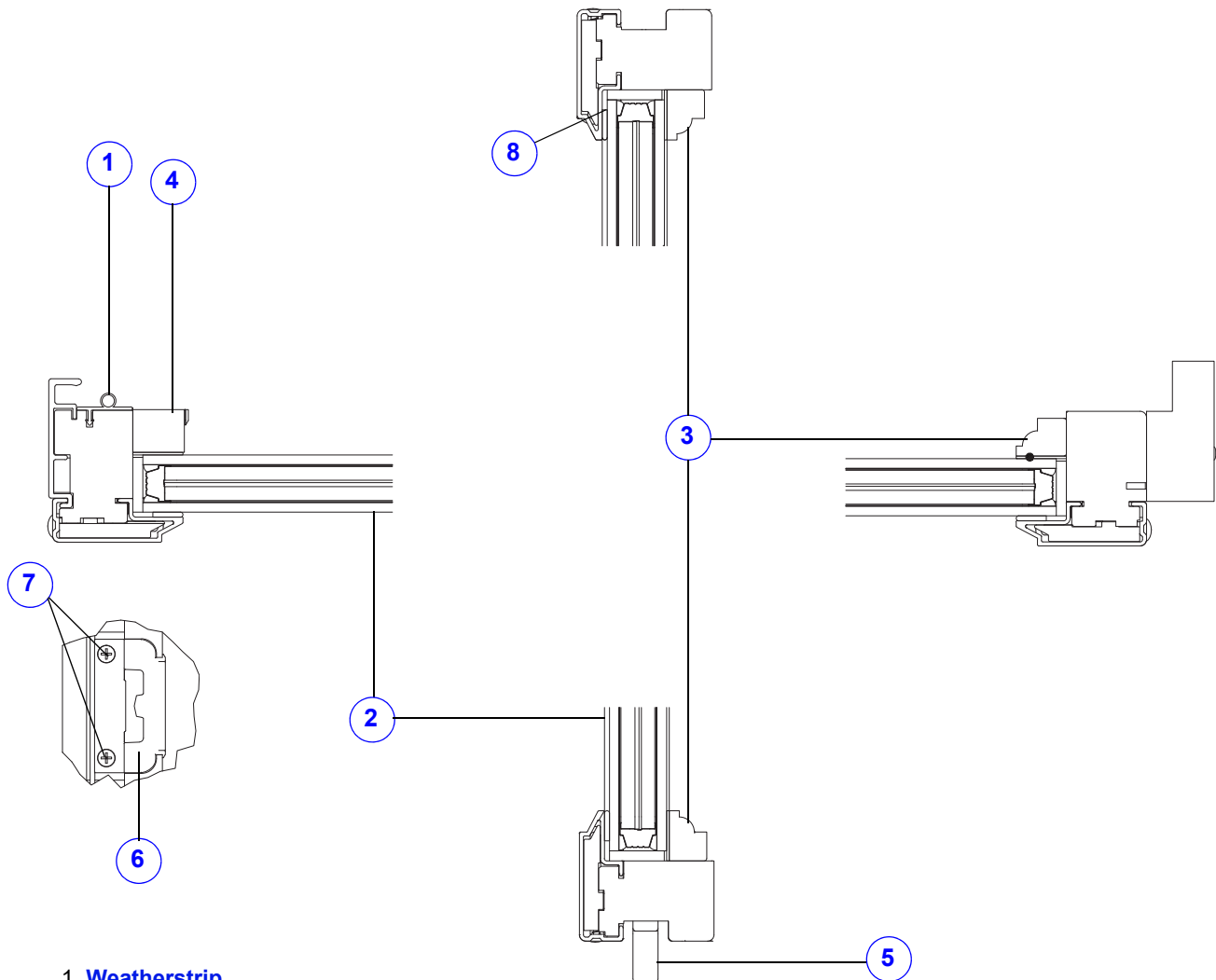

1. [Weatherstrip](#)
2. [Glass](#)
3. [Stop \(Ovolo\)](#)
4. [Stop \(Check Rail\)](#)
5. [Block Pin](#)
6. [Keeper](#)
7. [Screw \(Keeper\)](#)
8. [Spacer](#)

**E-Series Gliding Window Sash - Stationary**

# Sash

## Sash Options - Stationary

### Sash - Standard Window

**Note:**

Replacement sash for custom-sized windows is made to order. Current glazings replace previous vintage glazings. Product ID label is located on the head jamb. See [Service Guide 9069188](#) for sash replacement instructions.



TEMPERED UN  
 16 CFR 1201 II  
 ANSI Z97.1-2009  
 SCCC XXXX  
 CIG-XX Xmm MM/DD/YR  
 CAN/CGSB 12.1-M90

**Exterior color options:**  
**Interior species/finish/color options:**  
**Glass options (See Logo/Etching Examples):**

Low-E4®	Low-E4® HeatLock	Low-E4® Triple-Pane
Low-E4® SmartSun™	Low-E4® Smart-Sun HeatLock	Low-E4® Smart-Sun Triple-Pane
Low-E4® Passive Sun	Low-E4® Sun Heat-Lock	Low-E4® Enhanced Triple-Pane
Low-E4® Sun 3	Low-E4® HeatLock Tempered	Low-E4® Smart-Sun Enhanced Triple-Pane
Low-E4® Tempered	Dual Pane Clear	Low-E4® Enhanced Triple-Pane Heat-Lock
Low-E4® SmartSun Tempered	Cascade	Low-E4® Smart-Sun Enhanced Triple-Pane HeatLock
Low-E4® Passive Sun Tempered	Fern	
Low-E4® Sun Tempered	Reed	

To order, state:

Product ID (from product label, see [Service Guide 9051877](#))

OR

1. Unit or frame size (CSLD XXXX or frame W x H dimensions)
2. Unit sash ratio (Even, Cottage, Rev Cottage, SSR)
3. Description of part (Lower Sash)
4. Exterior color of sash
5. Hardware finish of lock
6. Interior wood species/finish/color of sash
7. Glazing/Grille type

# E-Series Gliding Windows (2014 to Present)

Standard Windows

## Sash

### Weatherstrip

#### Weatherstrip

**Note:**

Used on stationary sash. See [Service Guide 9069155](#).

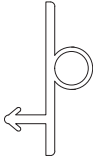

Size	Beige
36"	0654110
72"	0520152
102"	0520059
144"	0034816

### Weatherstrip

**Note:**

Used on operating sash. See [Service Guide 9069157](#).



Length	Color	Order No.
144"	White	0034815

### Sash Parts

#### Block Pin

**Note:**

Used on bottom of stationary sash.

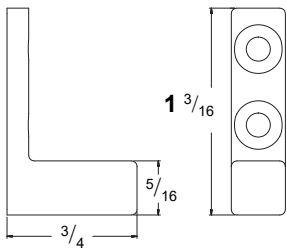

Order No.
OSL7022

## Sash

### Sash Hardware / Lift (Pull)

#### Sash Lift (Pull) / Traditional

**Note:**

See [Service Guide 9069189](#).

		<b>Color</b>	<b>Order No.</b>
		White	0SL1138
		Bronze	0SL1137
		Brass	0SL1139
		Black	0SL1173
		Gold	0SL1179
		Satin Chrome	0SL1399
		Oil-Rubbed Bronze	0228982

#### Screw / Sash Lift

	Description	Order No.
	#8 X 1 1/4 PFHSMS TYPE AB Z&Y BLK 192-02	9105810

# E-Series Gliding Windows (2014 to Present)

Standard Windows

## Sash

### Sash Hardware / Lock & Keeper

#### Lock

**Note:**

See [Service Guide 9069182](#).

	<b>Order No. (LH)</b>
	0011085

#### Lock Handle

**Note:**

Standard handle shown. Security handle used with Verilock®. See [Service Guide 9069143](#).

	<b>Color</b>	<b>Standard</b>	<b>Security</b>
	White	0009570	0014020
	Bronze	0009571	0014021
	Brass	0009572	0014022
	Black	0009573	0014023
	Gold	0009574	0014024
	Pewter	By description	0014025
	Oil-Rubbed Bronze	By description	0014026
	Satin Chrome	By description	0014027
	Bright Chrome	By description	0014028
	Antique Brass	By description	0014029

#### Screw / Lock Handle

	Description	Type	Order No.
	#8 x 7/8" PPHMS Zinc	Standard	0011087
	#8 x 3/4" PPHMS Zinc	Security	0010252

#### Washer / Lock Handle

**Note:**

See [Service Guide 9069143](#).

	<b>Order No.</b>
	9105335

#### Sensor Assembly / Verilock®

**Note:**

See [Service Guide 9067461](#).

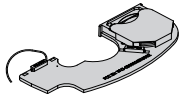
	<b>Order No.</b>
	0013723

## Sash

Lock Bezel Cover / Security			
	Color	LH	RH
	White	0014030	0014031
	Bronze	0014032	0014033
	Brass	0014034	0014035
	Black	0014036	0014037
	Gold	0014038	0014039
	Pewter	0014040	0014041
	Oil-Rubbed Bronze	0014042	0014043
	Satin Chrome	0014044	0014045
	Bright Chrome	0014046	0014047
	Antique Brass	0014048	0014049

Lock Bezel Plate			
	Color	LH	RH
	White	0009550	0009551
	Bronze	0009552	0009553
	Brass	0009554	0009555
	Black	0009556	0009557
	Gold	0009558	0009559
	Pewter	9105336	9105337
	Oil-Rubbed Bronze	9105338	9105339
	Satin Chrome	9105340	9105341
	Bright Chrome	9105342	9105343
	Antique Brass	9105344	9105345

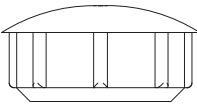
Lock Handle Plug			
<b>Note:</b> See <a href="#">Service Guide 9069143</a> .			
	Color	Order No.	
	White	0009580	
	Bronze	0009581	
	Brass	0009582	
	Black	0009583	
	Gold	0009584	
	Pewter	9105346	
	Oil-Rubbed Bronze	9105347	
	Satin Chrome	9105348	
	Bright Chrome	9105349	
	Antique Brass	9105350	
	Beige	0007029	



# E-Series Gliding Windows (2014 to Present)

Standard Windows

## Sash

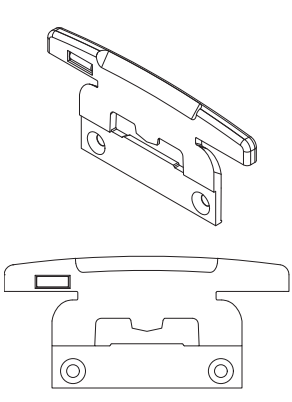
Lock Keeper				
<b>Note:</b> Security keeper shown. See <a href="#">Service Guide 9069181</a> (standard keeper shown).				
		<b>Color</b>	<b>Standard</b>	<b>Security</b>
		White	0034821	0014010
		Bronze	0034822	0014011
		Brass	0034823	0014012
		Black	0034824	0014013
		Gold	0034825	0014014
		Pewter	0034826	0014015
		Oil-Rubbed Bronze	0034827	0014016
		Satin Chrome	0034828	0014017
		Bright Chrome	0034829	0014018
		Antique Brass	0034830	0014019

Screw / Keeper			
	Description	Type	Order No.
	#7 x 7/8" PFHSMSMS Type AB SS	Standard	0015746

Sash Hardware / Roller			
Roller Assembly			
<b>Note:</b> See <a href="#">Service Guide 9069197</a> .			
			<b>Order No.</b>
			0007245

Screw / Roller Assembly		
	Description	Order No.
	#4 X 1/2 PFHSMS TYPE AB S.S. 18-8 STAINLESS STEEL	0009884

## Glass

Glass																										
<p><b>Note:</b> Replacement glass is made to order and can be configured through iQ+. Current glazings replace previous vintage glazings. Product ID label is located on the head jamb. Glass ships with sealant and spacers. See <a href="#">Accessory Guide 9176386</a>.</p>																										
<p>Low-E4®</p> <p>Low-E4® Sun 3</p> <p>Low-E4® SmartSun™</p> <p>Low-E4® PassiveSun®</p> <p>Dual Pane Clear</p> <p>Special Product Request (SPR)</p> <p>Low-E4® SmartSun™ HeatLock™</p> <p>Low-E4® HeatLock™</p>		<p><b>Exterior color options:</b> <b>Interior species/finish/color options:</b> <b>Glass options (See Logo/Etching Examples):</b></p> <table border="1"> <thead> <tr> <th>Low-E4®</th> <th>Low-E4® HeatLock</th> <th>Low-E4® SmartSun HeatLock</th> </tr> </thead> <tbody> <tr> <td>Low-E4® SmartSun™</td> <td>Low-E4® Smart-Sun HeatLock</td> <td>Low-E4® Triple-Pane</td> </tr> <tr> <td>Low-E4® Passive Sun</td> <td>Low-E4® Sun Heat-Lock</td> <td>Low-E4® Smart-Sun Triple-Pane</td> </tr> <tr> <td>Low-E4® Sun 3</td> <td>Low-E4® HeatLock Tempered</td> <td>Low-E4® Enhanced Triple-Pane</td> </tr> <tr> <td>Low-E4® Tempered</td> <td>Dual Pane Clear</td> <td>Low-E4® Smart-Sun Enhanced Triple-Pane</td> </tr> <tr> <td>Low-E4® SmartSun Tempered</td> <td>Cascade</td> <td>Low-E4® Enhanced Triple-Pane Heat-Lock</td> </tr> <tr> <td>Low-E4® Passive Sun Tempered</td> <td>Fern</td> <td>Low-E4® Smart-Sun Enhanced Triple-Pane HeatLock</td> </tr> <tr> <td>Low-E4® Sun Tempered</td> <td>Reed</td> <td></td> </tr> </tbody> </table> <p><i>To order, state:</i> <b>Product ID (from product label, see <a href="#">Service Guide 9051877</a>)</b> <b>OR</b></p> <ol style="list-style-type: none"> <li>Unit or frame size (CSLD XXXX or frame W x H dimensions)</li> <li>Description of part (Glass)</li> <li>Glazing/Grille type</li> <li>Glass Stop Type (Ovolo, Contemporary)</li> <li>Manufacturing Date</li> </ol>	Low-E4®	Low-E4® HeatLock	Low-E4® SmartSun HeatLock	Low-E4® SmartSun™	Low-E4® Smart-Sun HeatLock	Low-E4® Triple-Pane	Low-E4® Passive Sun	Low-E4® Sun Heat-Lock	Low-E4® Smart-Sun Triple-Pane	Low-E4® Sun 3	Low-E4® HeatLock Tempered	Low-E4® Enhanced Triple-Pane	Low-E4® Tempered	Dual Pane Clear	Low-E4® Smart-Sun Enhanced Triple-Pane	Low-E4® SmartSun Tempered	Cascade	Low-E4® Enhanced Triple-Pane Heat-Lock	Low-E4® Passive Sun Tempered	Fern	Low-E4® Smart-Sun Enhanced Triple-Pane HeatLock	Low-E4® Sun Tempered	Reed	
Low-E4®	Low-E4® HeatLock	Low-E4® SmartSun HeatLock																								
Low-E4® SmartSun™	Low-E4® Smart-Sun HeatLock	Low-E4® Triple-Pane																								
Low-E4® Passive Sun	Low-E4® Sun Heat-Lock	Low-E4® Smart-Sun Triple-Pane																								
Low-E4® Sun 3	Low-E4® HeatLock Tempered	Low-E4® Enhanced Triple-Pane																								
Low-E4® Tempered	Dual Pane Clear	Low-E4® Smart-Sun Enhanced Triple-Pane																								
Low-E4® SmartSun Tempered	Cascade	Low-E4® Enhanced Triple-Pane Heat-Lock																								
Low-E4® Passive Sun Tempered	Fern	Low-E4® Smart-Sun Enhanced Triple-Pane HeatLock																								
Low-E4® Sun Tempered	Reed																									
<p>TEMPERED UA 16 CFR 1201 II ANSI Z97.1-2009</p> <p>SGCC XXXX CIG-XX Xmm MM/DD/YR CAN/CGSB 12.1-M90</p>																										

## Glass Stops

### Stops - Top / Bottom / Side

**Note:**

Stops (top, bottom, check rail and side) are made to order.

To order, state:

Product ID (from product label, see [Service Guide 9051877](#))

OR

1. Description of Part/Size (Stop)
2. Color/Species/Finish
3. Location/Handing (Top, Bottom, Check Rail, Side)
4. Type (Ovolo, Contemporary)
5. Manufacturing Date

### Interior species/finish/color options

**WOOD SPECIES**

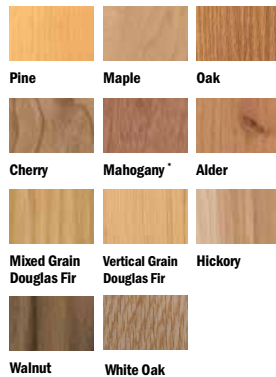

**FACTORY-FINISHED INTERIORS**



**PAINTED OPTIONS**

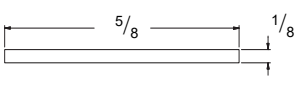

## Glass

Glass Parts			
Glazing Tape			
		Color	Order No.
		Gray	33751RL
		Black	10374RL
Silicone Bed Glazing			
		Color	Order No.
		Dove Gray	9164412
Spacer			
			Order No.
			9152146

## Insect Screens

### Insect Screen Graphic - Full

**Note:**

Replacement screen is made to order and can be configured through iQ+. Full screens are not used on three panel units.

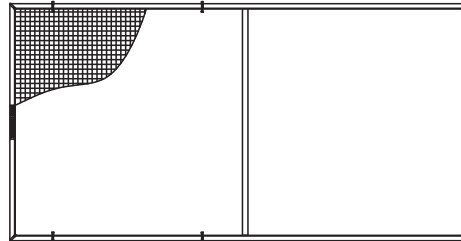
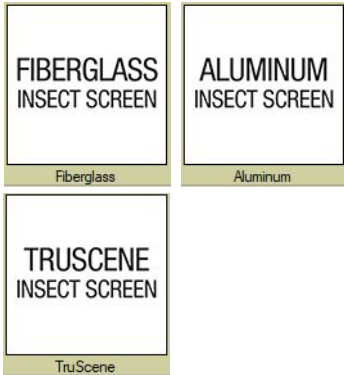

**Note:**

Multiple screen options available.

**Color options:**

**Mesh options:** See iQ+

*To order, state:*

1. Description of Part (Full Insect Screen, color, mesh type)
2. Style (XO/OX)
3. Quantity
4. Product ID (from product label, see [Service Guide 9051877](#))

## Insect Screens

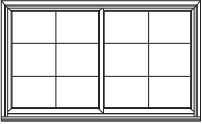
<b>Insect Screen Size Table - Full</b>		
<b>Insect Screen Size Table - OX/XO Units</b>		
<b>Unit No.</b>	<b>Screen Dimensions (w x h)</b>	
<b>30</b>	<b>SLD3020</b>	33 1/16 x 21 15/16
	<b>SLD3030</b>	33 1/16 x 33 15/16
<b>40</b>	<b>SLD4020</b>	45 1/16 x 21 15/16
	<b>SLD4030</b>	45 1/16 x 33 15/16
	<b>SLD4034</b>	45 1/16 x 37 15/16
	<b>SLD4040</b>	45 1/16 x 45 15/16
	<b>SLD4046</b>	45 1/16 x 51 15/16
	<b>SLD4050</b>	45 1/16 x 57 15/16
<b>50</b>	<b>SLD5020</b>	57 1/16 x 21 15/16
	<b>SLD5030</b>	57 1/16 x 33 15/16
	<b>SLD5034</b>	57 1/16 x 37 15/16
	<b>SLD5040</b>	57 1/16 x 45 15/16
	<b>SLD5046</b>	57 1/16 x 51 15/16
	<b>SLD5050</b>	57 1/16 x 57 15/16
<b>60</b>	<b>SLD6020</b>	69 1/16 x 21 15/16
	<b>SLD6030</b>	69 1/16 x 33 15/16
	<b>SLD6034</b>	69 1/16 x 37 15/16
	<b>SLD6040</b>	69 1/16 x 45 15/16
	<b>SLD6046</b>	69 1/16 x 51 15/16
	<b>SLD6050</b>	69 1/16 x 57 15/16

### Insect Screen Graphic - Half

**Note:**

Replacement screen is made to order and can be configured through iQ+.



Fiberglass



Aluminum

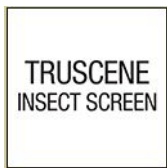

TruScene

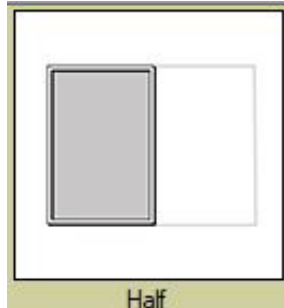

**Note:**

Multiple screen options available.

**Color options:**

**Mesh options:** See iQ+

*To order, state:*

1. **Description of Part (Half Insect Screen, color, mesh type)**
2. **Style (XO/OX, XOX)**
3. **Quantity**
4. **Product ID (from product label, see [Service Guide 9051877](#))**

## Insect Screens

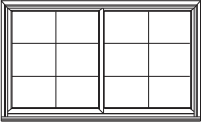
<b>Insect Screen Size Table - Half</b>		
<b>Insect Screen Size Table - OX/XO Units</b>		
<b>Unit No.</b>	<b>Screen Dimensions (w x h)</b>	
<b>30</b>	<b>SLD3020</b>	16 1/16 x 21 15/16
	<b>SLD3030</b>	16 1/16 x 33 15/16
<b>40</b>	<b>SLD4020</b>	22 1/16 x 21 15/16
	<b>SLD4030</b>	22 1/16 x 33 15/16
	<b>SLD4034</b>	22 1/16 x 37 15/16
	<b>SLD4040</b>	22 1/16 x 45 15/16
	<b>SLD4046</b>	22 1/16 x 51 15/16
	<b>SLD4050</b>	22 1/16 x 57 15/16
<b>50</b>	<b>SLD5020</b>	28 1/16 x 21 15/16
	<b>SLD5030</b>	28 1/16 x 33 15/16
	<b>SLD5034</b>	28 1/16 x 37 15/16
	<b>SLD5040</b>	28 1/16 x 45 15/16
	<b>SLD5046</b>	28 1/16 x 51 15/16
	<b>SLD5050</b>	28 1/16 x 57 15/16
<b>60</b>	<b>SLD6020</b>	34 1/16 x 21 15/16
	<b>SLD6030</b>	34 1/16 x 33 15/16
	<b>SLD6034</b>	34 1/16 x 37 15/16
	<b>SLD6040</b>	34 1/16 x 45 15/16
	<b>SLD6046</b>	34 1/16 x 51 15/16
	<b>SLD6050</b>	34 1/16 x 57 15/16



# E-Series Gliding Windows (2014 to Present)

Standard Windows

## Insect Screens

**Insect Screen Size Table - XOX Units**

**Note:**

3-sash gliding units (XOX) use 2'0" operating sash as standard. Additional sash ratios also available.

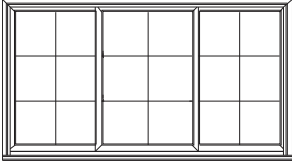
Unit No.		Sash Dimensions (w x h)	
<b>60</b>	<b>SLD6020</b>	22 1/8 x 21 15/16	
	<b>SLD6030</b>	22 1/8 x 33 15/16	
	<b>SLD6034</b>	22 1/8 x 37 15/16	
	<b>SLD6040</b>	22 1/8 x 45 15/16	
	<b>SLD6046</b>	22 1/8 x 51 15/16	
	<b>SLD6050</b>	22 1/8 x 57 15/16	
<b>80</b>	<b>SLD8020</b>	22 1/8 x 21 15/16	
	<b>SLD8030</b>	22 1/8 x 33 15/16	
	<b>SLD8034</b>	22 1/8 x 37 15/16	
	<b>SLD8040</b>	22 1/8 x 45 15/16	
	<b>SLD8046</b>	22 1/8 x 51 15/16	
	<b>SLD8050</b>	22 1/8 x 57 15/16	

## Insect Screens

### Insect Screen Retainer

#### Insect Screen Retainer / Half Screen / 144"

**Note:**

(\*) Anodized finishes. See [color options](#). Cut to size.

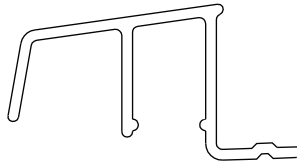

Color	2604	2605	Color	2604	2605
Colony White	0078200	00K9150	Moss	0078225	00K9190
White	0047052	0K14105	Forest Green		
Eagle Abalone	0078218	00K9174	Mallard Green	0078210	00K9160
Balsa White	0078205	00K9155	Spearmint	0066037	00K9183
Canvas	0011292	0K18155	Aquamarine	0066036	00K9182
Maple Syrup	0078220	00K9176	Patina	0066040	00K9189
Harvest Gold	0066034	00K9172	Sky Blue	0066029	00K9162
Prairie Grass	0011295	0K18158	Country Blue	0078208	00K9158
Flagstone	0078207	00K9157	Blue Denim	0078221	00K9177
Sandtone	0047050	0K14103	Watercolor Blue	0066031	00K9167
Pebble Tan	0078202	00K1356	Caribbean Blue	0066035	00K9180
Carmel	0078214	00K9166	Slate	0078222	00K9178
Terratone	0047051	0K14104	Moody Blue	0066030	00K9163
Hot Chocolate	0078223	00K9179	Stormy Blue	0078206	00K9156
Bourbon	0076686	00K9193	Dove Gray	0011293	0K18156
Acorn	0078227	00K9192	Harbor Mist	0078216	00K9171
Coffee Bean	0078229	00K9195	Yorktown Pewter	0066033	00K9170
Cocoa Bean	0011294	0K18157	Smokey Gray	0078226	00K9191
Dark Bronze	0049429	0K20924	Mystic Gray	0078232	00K9198
Clay Canyon	0078215	00K9168	Dark Ash	0078231	00K9197
Cardinal Red		00K9187	Black	0011291	0K18154
Bing Cherry		00K9186	Clear Anodized*		0075791
Fire Engine Red		00K1991	Champagne*		0075792
Cinnamon Toast	0078211	00K9161	Light Bronze*		0075793
Red Rock	0011296	0K18159	Medium Bronze*		0075794
Olive	0078209	00K9159	Copper*		
Sage	0078230	00K9196	Dark Bronze*		0075795
Billiard Green	0066032	00K9169	Black*		0075797

# E-Series Gliding Windows (2014 to Present)

Standard Windows

## Insect Screens

### Insect Screen Retainer

#### Insect Screen Retainer / Half Screen / 144"

**Note:**

(\*) Anodized finishes. See [color options](#). Cut to size.

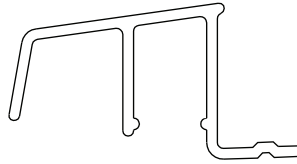

Color	2604	2605	Color	2604	2605
Eagle Black	0078219	00K9175			
Eagle Cappuccino	0078228	00K9194			
Bronze	0078201				
Eagle Linen	0078233	00K9152			
Eagle Blue Mist	0066038	00K9184			
Eagle Pink Chablis	0066039	00K9185			
Eagle Butterscotch	0078212	00K9164			
Eagle Elephant	0078224	00K9181			
Eagle Chocolate Chip	0078213	00K9165			
Eagle Forest Green	0078203	00K9153			
Antique White	0078204	00K9154			
Eagle Gray Flannel	0078217	00K9173			

### Insect Screen Parts

#### Screw

**Note:**

Used to secure half screen retainer.

	Description	Order No.
	#8 x 1/2" PPH TEKS #2 Zinc	0013441

# Grilles

## Grilles

**Note:**

Replacement sash with permanently applied grilles and finelight grilles can be configured in iQ+. Replacement removable interior grilles can be configured in iQ+. Removable grilles are only available in 7/8" profile.

**Exterior color/finish options**



**ANNODIZED FINISHES**



**Interior species/finish/color options**

**WOOD SPECIES**

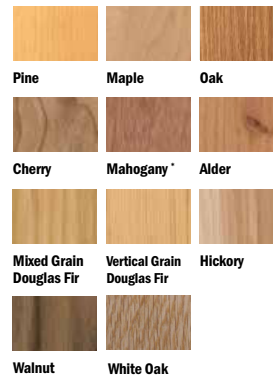

**FACTORY-FINISHED INTERIORS**



**PAINTED OPTIONS**



Painted options available with pine and maple only.

## Grilles

### Grille Options

**Note:**

Replacement sash with permanently applied grilles and finelight grilles can be configured in iQ+. Replacement removable interior grilles can be configured in iQ+. Removable grilles are only available in 7/8" profile.

### Types



**Full Divided Light**

Give any window an authentic look with full divided light grilles that are permanently applied to the interior and exterior of your window with a spacer between the glass.



**Simulated Divided Light**

An economical solution with traditional beauty, our Simulated Divided Light features fixed exterior and interior grilles without an internal spacer.



**Removable Interior Wood Grilles**

Our removable wood grilles are installed on the interior surface. They are available with an optional surround and an optional permanently applied exterior grille.



**Finelight™ Grilles-Between-the-Glass**

Aluminum grilles conveniently placed between two panes of glass make the glass easy to clean inside and out.

### Profiles

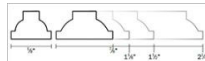

**Interior Wood: Ovolo (Colonial)**

Widths:

- 5/8"
- 7/8"
- 1 1/8"
- 1 1/2"
- 2 1/4"

Available with:

- Full Divided Light
- Simulated Divided Light

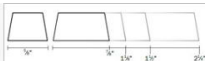

**Interior Wood: Contemporary**

Widths:

- 5/8"
- 7/8"
- 1 1/8"
- 1 1/2"
- 2 1/4"

Available with:

- Full Divided Light
- Simulated Divided Light

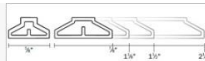

**Exterior Aluminum: Chamfer**

Widths:

- 5/8"
- 7/8"
- 1 1/8"
- 1 1/2"
- 2 1/4"

Available with:

- Full Divided Light
- Simulated Divided Light
- Removable Interior Wood with Optional Permanently Applied Exterior Grille

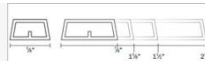

**Exterior Aluminum: Contemporary**

Widths:

- 5/8"
- 7/8"
- 1 1/8"
- 1 1/2"
- 2 1/4"

Available with:

- Full Divided Light
- Simulated Divided Light
- Removable Interior Wood with Optional Permanently Applied Exterior Grille

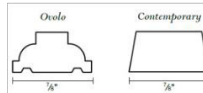

**Removable Interior Wood Grilles**

Ovolo or Contemporary profiles in 7/8" width

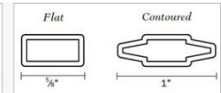

**Finelight Grille Profiles and Widths**

Flat or Contoured profiles in 5/8" or 1" widths

### Patterns

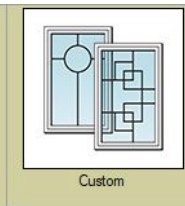
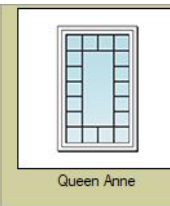
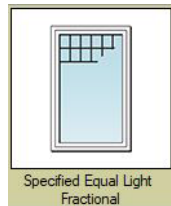
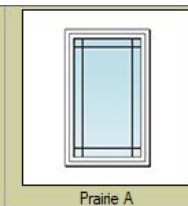
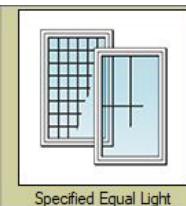
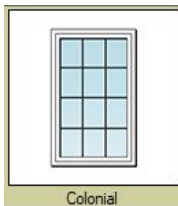

## Grilles

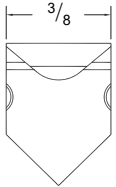
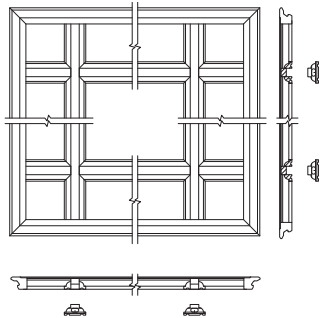
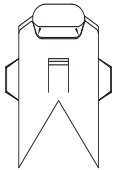
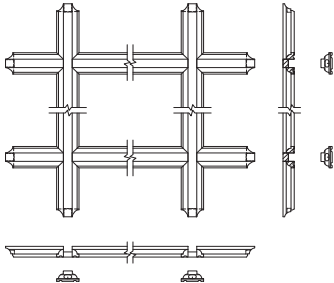
<b>Interior Grille Parts</b>				
<b>Clip - Surround</b>				
<b>Note:</b> Used with framed removable grilles.				
		<table border="1" style="width: 100%; border-collapse: collapse;"> <tr> <td style="padding: 5px;"><b>Order No.</b></td> </tr> <tr> <td style="padding: 5px; text-align: center;">0004900</td> </tr> </table>	<b>Order No.</b>	0004900
<b>Order No.</b>				
0004900				
<b>Clip - Knocked Down</b>				
<b>Note:</b> Used with knocked down removable grilles.				
		<table border="1" style="width: 100%; border-collapse: collapse;"> <tr> <td style="padding: 5px;"><b>Order No.</b></td> </tr> <tr> <td style="padding: 5px; text-align: center;">0004901</td> </tr> </table>	<b>Order No.</b>	0004901
<b>Order No.</b>				
0004901				

### Frame Graphic - Vertical / Horizontal

**Note:**

See current frame [Product Details](#).

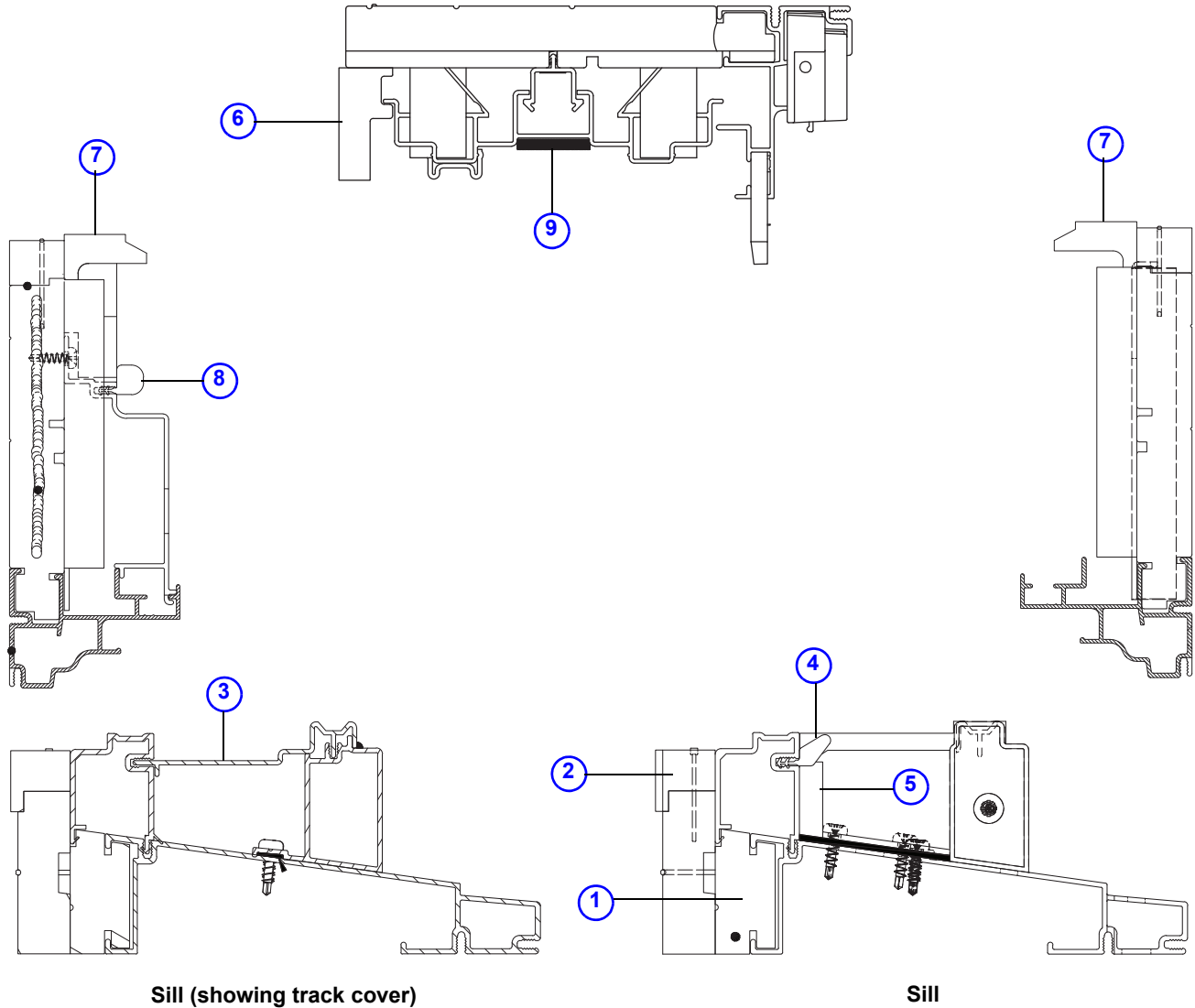

- |                                     |                                 |
|-------------------------------------|---------------------------------|
| 1. <a href="#">Thermal Block</a>    | 6. <a href="#">Head Stop</a>    |
| 2. <a href="#">Sill Stool</a>       | 7. <a href="#">Side Stop</a>    |
| 3. <a href="#">Sill Track Cover</a> | 8. <a href="#">Weatherstrip</a> |
| 4. <a href="#">Weatherstrip</a>     | 9. <a href="#">Dust Pad</a>     |
| 5. <a href="#">Foam Pad</a>         |                                 |

### E-Series Gliding Windows Frame Assembly

Frames

Frame Graphic - Top View

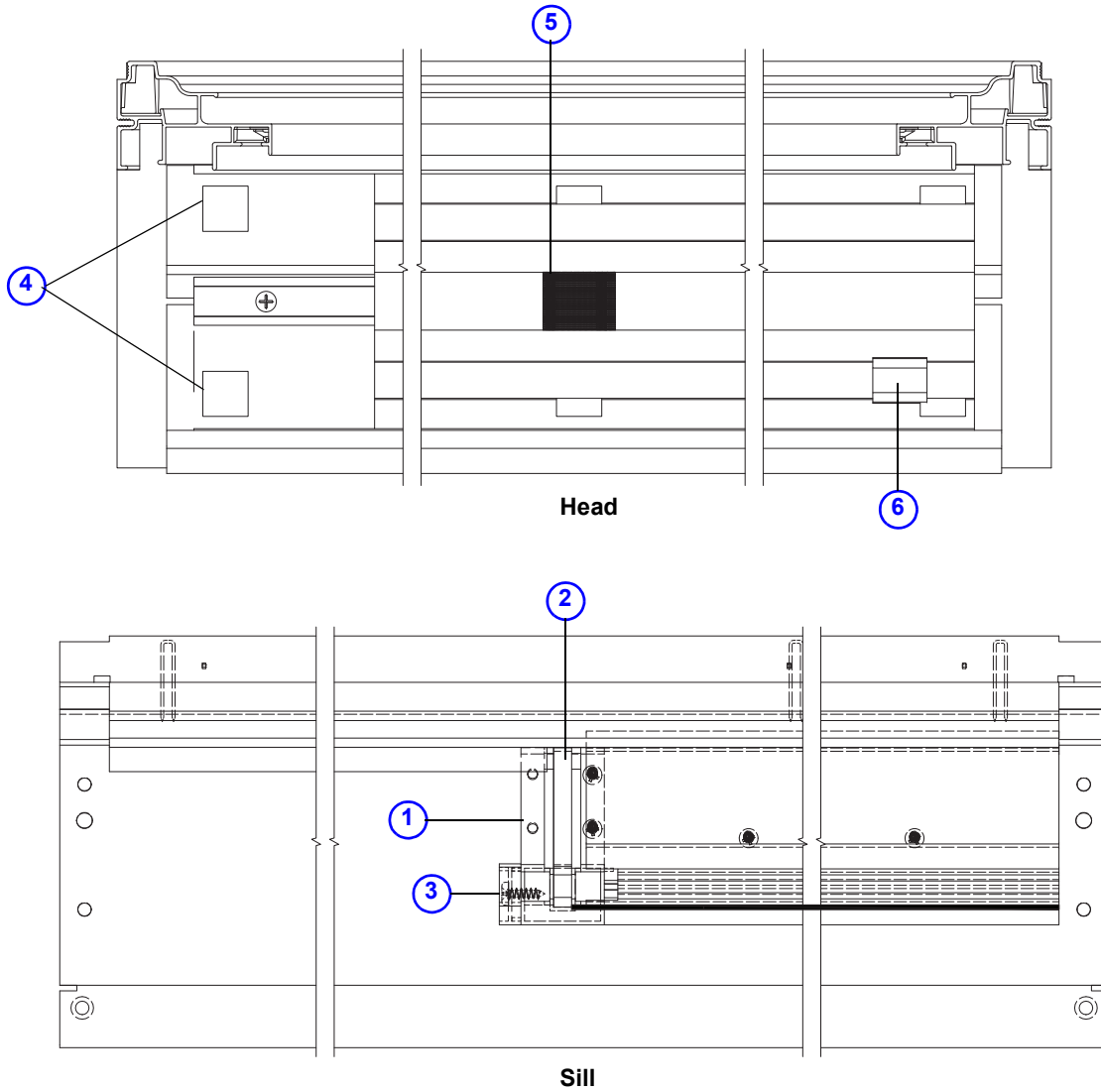

- 1. [Sill Track Block](#)
- 2. [Foam Sill Seal](#)
- 3. [Sill Block Cover](#)
- 4. [Foam Plug \(Head\)](#)
- 5. [Dust Pad](#)
- 6. [Sash Stop \(Head\)](#)

E-Series Gliding Windows Frame Assembly



### Frame

**Note:**

Available as configured through iQ+.

To order, state:

Product ID (from product label, see [Service Guide 9051877](#))

OR

1. Description of Part/Size (CSLD XXXX or frame W X H dimensions)
2. Colors/Species/Finish
3. Manufacturing Date

#### Exterior color/finish options



#### ANNODIZED FINISHES



#### Interior species/finish/color options

##### WOOD SPECIES

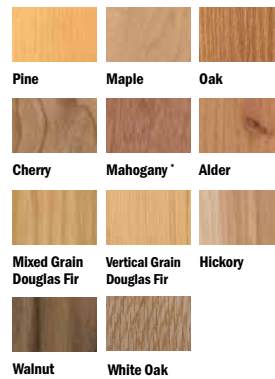

##### FACTORY-FINISHED INTERIORS

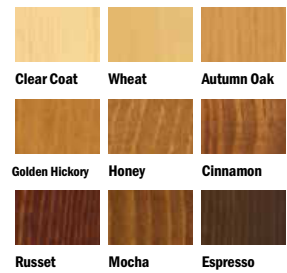

##### PAINTED OPTIONS



## Frames

### Stops

#### Stops / Blocks / Stools - Head / Sill / Side

**Note:**

Stops (head, head parting, side and sill) are made to order.

To order, state:

Product ID (from product label, see [Service Guide 9051877](#))

OR

1. Description of Part/Size (Stop/Block/Stool)
2. Color/Species/Finish
3. Location/Handing (Head, Sill, Side)
4. Manufacturing Date

**Interior species/finish/color options:**

**WOOD SPECIES**

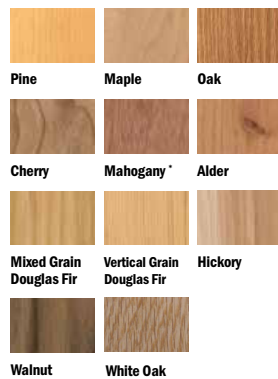

**FACTORY-FINISHED INTERIORS**



**PAINTED OPTIONS**



# E-Series Gliding Windows (2014 to Present)

Standard Windows

## Frames

### Weatherstrip

Weatherstrip Ref. No. 4 [page 33](#)

**Note:**

See [Service Guide 9069183](#).

		Length	Color	Order No.
		8 ft (96")	Tan	9183924

### Weatherstrip - Frame / Side Jamb Ref. 8 [page 33](#)

**Note:**

See [Service Guide 9069180](#).

		Length	Color	Order No.
		72"	White	9096436
			Beige	9096435

## Frames

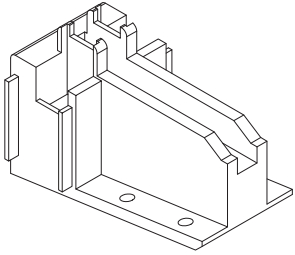
Frame Parts			
Block / Sill Track			
		Finish	Order No.
		Bronze	0002939
		Green	0002940
		White	0009245
		Tan	0009246
Black	0046398		

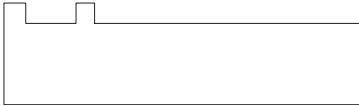
Foam Seal / Sill		
		Order No.
		0SL5519

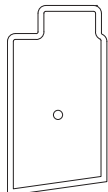
Cover / Sill Block			
		Finish	Order No.
		Bronze	0002937
		Green	0002938
		White	0008208
		Tan	0008209
Black	0046399		

Cover / Sill Track	
	<p><b>Note:</b> Sill track cover is made to order.</p> <p><i>To order, state:</i></p> <ol style="list-style-type: none"> <li><b>Description of Part (Cover - Sill Track)</b></li> <li><b>Quantity</b></li> <li><b>Size</b></li> <li><b>Color (Beige, White)</b></li> </ol>

Foam Pad / Sill		
		Order No.
		0075244

Foam Plug / Head		
		Order No.
		0038252

# E-Series Gliding Windows (2014 to Present)

Standard Windows

## Frames

Dust Pad / Head		
		<b>Order No.</b>
		0JB7007

Sash Stop / Head				
		<b>Color</b>	<b>Size</b>	<b>Order No.</b>
		White	$\frac{3}{4}$ "	0007175
			<b>3"</b>	9105331
		Beige	$\frac{3}{4}$ "	0007174
			<b>3"</b>	9105330

## Frames

### Extension Jamb

#### Extension Jamb

**Note:**  
Extension jambs can be configured through iQ+.

#### Interior species/finish/color options

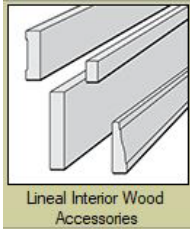

##### WOOD SPECIES



Pine Maple Oak



Cherry Mahogany\* Alder



Mixed Grain Douglas Fir Vertical Grain Douglas Fir Hickory



Walnut White Oak

##### FACTORY-FINISHED INTERIORS



Clear Coat Wheat Autumn Oak



Golden Hickory Honey Cinnamon



Russet Mocha Espresso

##### PAINTED OPTIONS



White Birch Bark Primed (for paint)



Canvas Sandtone Terratone



Forest Green Dark Bronze Dove Gray



Prairie Grass Red Rock Cocoa Bean



Black

Painted options available with pine and maple only.

### Casing

#### Casing

**Note:**

Interior casing can be configured through iQ+.

**Interior species/finish/color options**

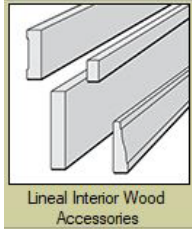

**WOOD SPECIES**

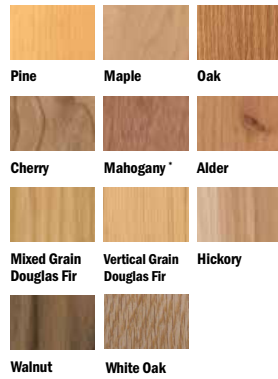

**FACTORY-FINISHED INTERIORS**



**PAINTED OPTIONS**



## Joining Components

### Joining Components

#### Joining Components

**Note:**

Joining components (casing) can be configured through iQ+.

Interior species/finish/color options

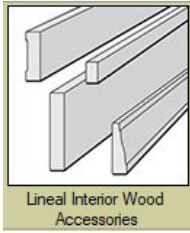

**WOOD SPECIES**

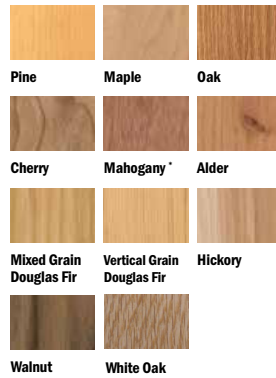

**FACTORY-FINISHED INTERIORS**



**PAINTED OPTIONS**

