

What's in This Section

Standard Windows	Page 3
Parts Illustration	3
Parts Illustration	3
Colors - Exterior	4
Colors/Species/Finishes - Interior	5
Unit Sizes	6
Standard and Custom Window Sizes	6
E-Series Product Label	6
Unit Size Chart - Standard Windows	7
Product History	8
Product History	8
Sash	9
Sash Size Table	9
Sash Graphic / Active	10
Sash Graphic / Inactive	11
Sash Graphic / Detail	12
Sash	13
Sash Parts	14
Weatherstrip	14
Glass	15
Glass	15
Glass Stops	16
Glass Parts	17
Insect Screens	18
Insect Screen	18
Insect Screen - Standard Screens	19
Insect Screen Parts	20
Grilles	21
Grilles	21
Grille Options	22
Interior Grille Parts	23
Hardware	24
Operator	24
Hinge - Piano	25
Operator Cover	25
Handles	26
Locks and Lock Components	27

Optional Hardware	29
Fasteners	30
Frames	31
Frame - Side Jambs	31
Frame - Head Jamb and Sill	32
Frame	33
Stops	34
Weatherstrip	35
Frame Parts	35

E-Series French Casement Windows (2014 to Present)

Standard Windows

Parts Illustration

Parts Illustration

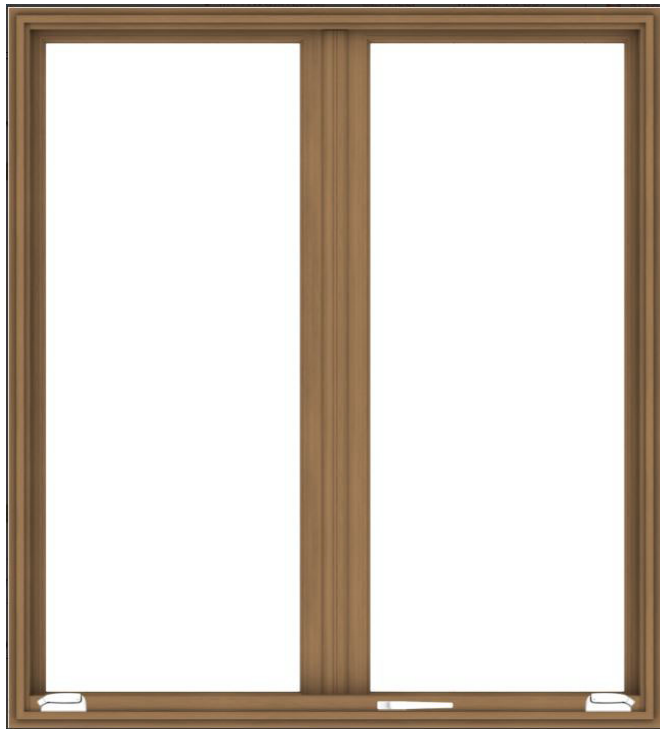

Manufactured 2012 to Present

E-Series French Casement Window Unit Parts

Unit viewed from exterior.

Parts Illustration

Colors - Exterior

Note:
(*) Anodized Finishes

				Colony White	White	Abalone	Balsa White
			Canvas	Maple Syrup	Harvest Gold	Prairie Grass	
Flagstone	Sandtone	Pebble Tan	Carmel	Terratone	Hot Chocolate	Bourbon	
Acorn	Coffee Bean	Cocoa Bean	Sierra Bronze	Dark Bronze	Clay Canyon	Red Rock	
Cardinal	Bing Cherry	Fire Engine Red	Cinnamon Toast	Olive	Sage	Billiard Green	
Moss	Forest Green	Mallard Green	Spearmint	Aquamarine	Patina	Sky Blue	
Country Blue	Blue Denim	Watercolor Blue	Caribbean Blue	Slate	Moody Blue	Stormy Blue	
Dove Gray	Harbor Mist	Yorktown Pewter	Smokey Gray	Mystic Gray	Dark Ash	Black	
Light Bronze*	Champagne*	Clear Anodized*	Black	Dark Bronze*	Copper*	Medium Bronze*	

Colors/Species/Finishes - Interior

Species Interior Options



Pine



Mixed Grain
Douglas Fir



Oak



Maple

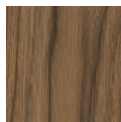

Walnut



Alder



Hickory



Mahogany



Vertical Grain
Douglas Fir



Cherry



White Oak

Stained Interior Options



Clear Coat



Wheat



Autumn Oak



Golden Hickory



Honey

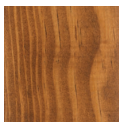

Cinnamon

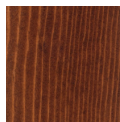

Russet



Mocha

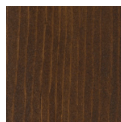

Espresso

Painted Interior Options

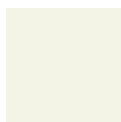

White

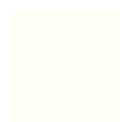

Birch Bark

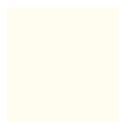

Primed



Canvas



Sandtone



Terratone



Forest Green



Dark Bronze



Dove Gray



Prairie Grass



Red Rock



Cocoa Bean



Black



Anodized Silver ¹

Unit Sizes

Standard and Custom Window Sizes

Note:

E-Series French Casement Windows are available in standard sizes (see standard size charts, [page 6](#)). Replacement parts for some standard windows can be ordered using the numbers listed in this catalog. Many replacement parts for standard windows are made to order. These items are ordered using the Product ID found on the identification label and a description of the part needed. See [Service Guide 9051877](#).

E-Series French Casement Windows are also available in custom sizes in 1/8" increments between the smallest and the largest standard sizes. Most replacement parts for custom-sized windows are made to order and can be ordered with the Product ID found on the identification label and a description of the part needed. See [Service Guide 9051877](#).

E-Series Product Label

Note:

Every E-Series French Casement Window will have an identification label **or** glass etching containing a unique Product ID. The Product ID on E-Series French Casement Windows will be located at the top of the window frame or etched into the glass. See [Service Guide 9051877](#). The Product ID may be up to 14 digits long (excluding hyphens), depending on the age of the unit. Replacement parts will also get their own unique Product ID. When ordering replacement parts, providing the Product ID ensures that replacement parts match the specifications.

E-Series French Casement Windows (2014 to Present)

Standard Windows





Unit Sizes

Unit Size Chart - Standard Windows

Note:

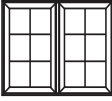
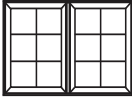
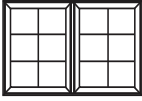
F.S. refers to overall outside-to-outside frame. R.O. refers to rough opening. V.G. refers to visible glass. See latest [Size Grid](#).

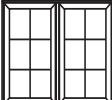
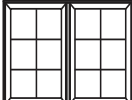
French Casement Window Sizes

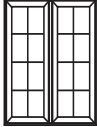
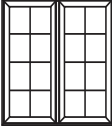
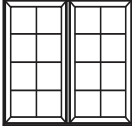
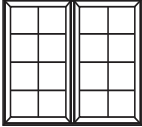
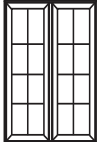
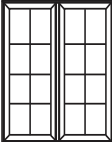
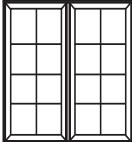
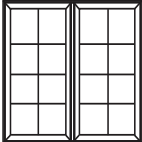
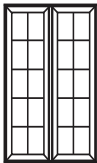
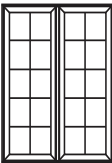
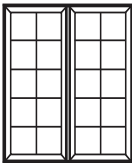
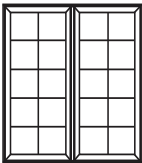
	3' 4 1/2"	4' 0 1/2"	4' 8 1/2"	5' 0 1/2"
	3' 4"	4' 0"	4' 8"	5' 0"
	13 7/8"	1' 5 7/8"	1' 9 7/8"	1' 11 7/8"
R.O.				
F.S.				
V.G.				
3' 0 1/2"				
	FCMT3430	FCMT4030	FCMT4830	FCMT5030
3' 4 1/2"				
	FCMT3434	FCMT4034	FCMT4834	FCMT5034
4' 0 1/2"				
	FCMT3440 †	FCMT4040 †	FCMT4840 †	FCMT5040 †
4' 6 1/2"				
	FCMT3446 †	FCMT4046 †	FCMT4846 †	FCMT5046 †
5' 0 1/2"				
	FCMT3450 †	FCMT4050 †	FCMT4850 †	FCMT5050 †

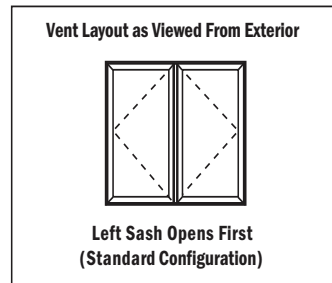

NOTES

† These units meet or exceed the following dimensions: Clear Opening Area 5.7 sq. ft., Clear Opening Width 20", Clear Opening Height 24" and 44" maximum floor to sill height (with standard 6' 10 1/2" structural mull header height). Local codes may differ. Verify egress requirements with your local building code official

Piano hinges and step jamb are standard on all French casement units.

E-Series French Casement Standard Window Unit Sizes

Product History

Product History

- 2022** White Oak introduced
- 2022** Stormwatch® (not shown in catalog) discontinued. See [Bulletin 80-21](#) for more detail.

E-Series French Casement Windows (2014 to Present)

Standard Windows

Sash

Sash Size Table

Note:

Sash shown is Venting French Casement. Overall Sash is measured outside edge to outside edge of sash frame (does not include astragal).

Sash Size Table				
Unit No.		Sash Dimensions (w x h)	Visible Glass Dimensions (w x h)	Graphic
34	FCAX3430	18 1/2 x 34 1/2	13 7/8 x 29 7/8	
	FCAX3434	18 1/2 x 38 1/2	13 7/8 x 33 7/8	
	FCAX3440	18 1/2 x 46 1/2	13 7/8 x 41 7/8	
	FCAX3446	18 1/2 x 52 1/2	13 7/8 x 47 7/8	
	FCAX3450	18 1/2 x 58 1/2	13 7/8 x 53 7/8	
40	FCAX4030	22 1/2 x 34 1/2	17 7/8 x 29 7/8	
	FCAX4034	22 1/2 x 38 1/2	17 7/8 x 33 7/8	
	FCAX4040	22 1/2 x 46 1/2	17 7/8 x 41 7/8	
	FCAX4046	22 1/2 x 52 1/2	17 7/8 x 47 7/8	
	FCAX4050	22 1/2 x 58 1/2	17 7/8 x 53 7/8	
48	FCAX4830	26 1/2 x 34 1/2	21 7/8 x 29 7/8	
	FCAX4834	26 1/2 x 38 1/2	21 7/8 x 33 7/8	
	FCAX4840	26 1/2 x 46 1/2	21 7/8 x 41 7/8	
	FCAX4846	26 1/2 x 52 1/2	21 7/8 x 47 7/8	
	FCAX4850	26 1/2 x 58 1/2	21 7/8 x 53 7/8	
50	FCAX5030	28 1/2 x 34 1/2	23 7/8 x 29 7/8	
	FCAX5034	28 1/2 x 38 1/2	23 7/8 x 33 7/8	
	FCAX5040	28 1/2 x 46 1/2	23 7/8 x 41 7/8	
	FCAX5046	28 1/2 x 52 1/2	23 7/8 x 47 7/8	
	FCAX5050	28 1/2 x 58 1/2	23 7/8 x 53 7/8	

Sash

Sash Graphic / Active

Note:

Active French Casement sash shown. See additional [casement types](#).

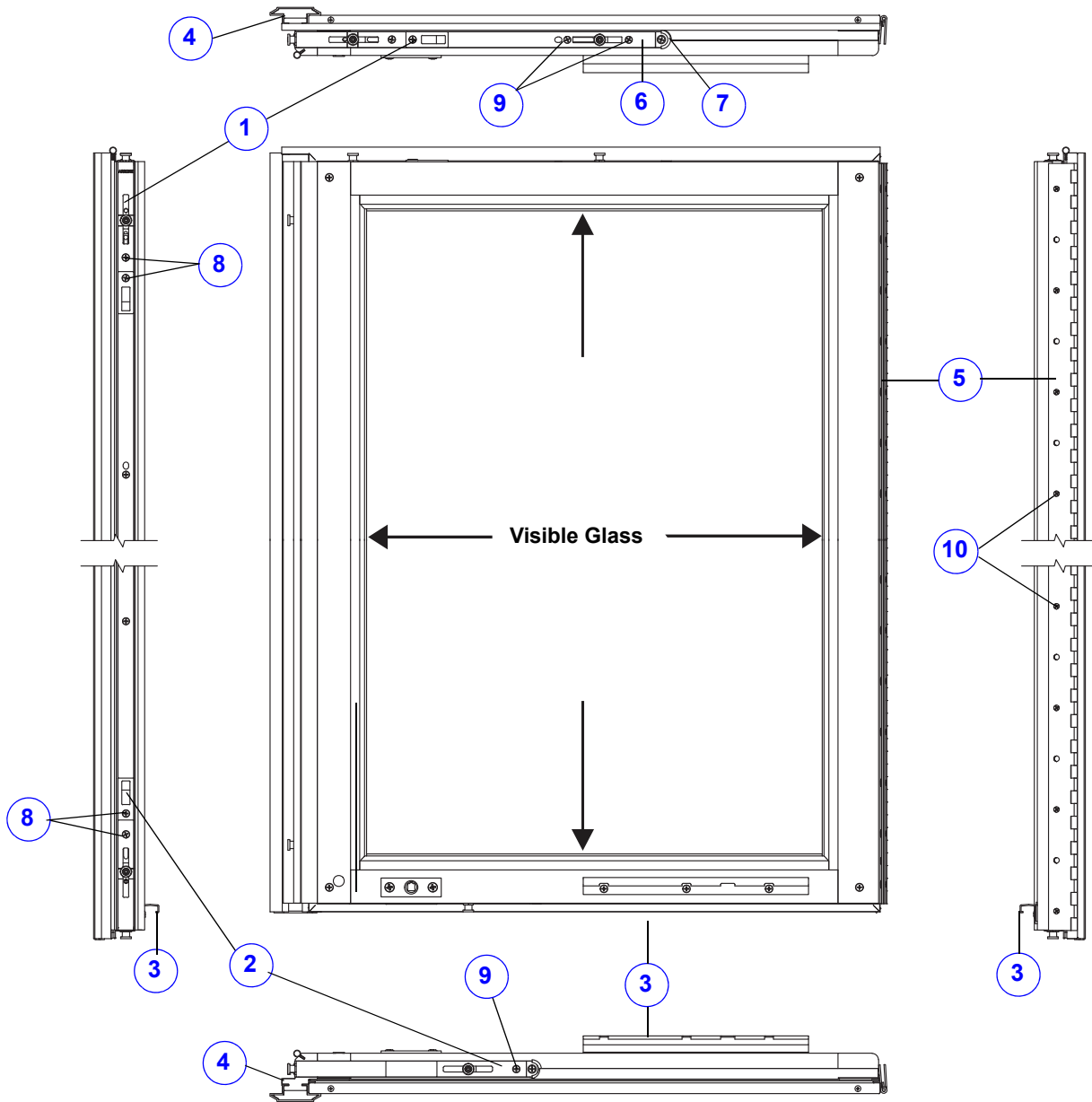

- | | |
|----------------------------------|--|
| 1. Upper Gear | 6. Lock Extension |
| 2. Lower Gear | 7. Groove Cover |
| 3. Sash Track | 8. Screw (Gears) |
| 4. Astragal | 9. Screw (Extension & Cover) |
| 5. Hinge (Piano) | 10. Screw (Piano Hinge) |

E-Series French Casement Active Sash

Sash viewed from interior

Sash Graphic / Inactive

Note:

Inactive French Casement sash shown. See additional [casement types](#).

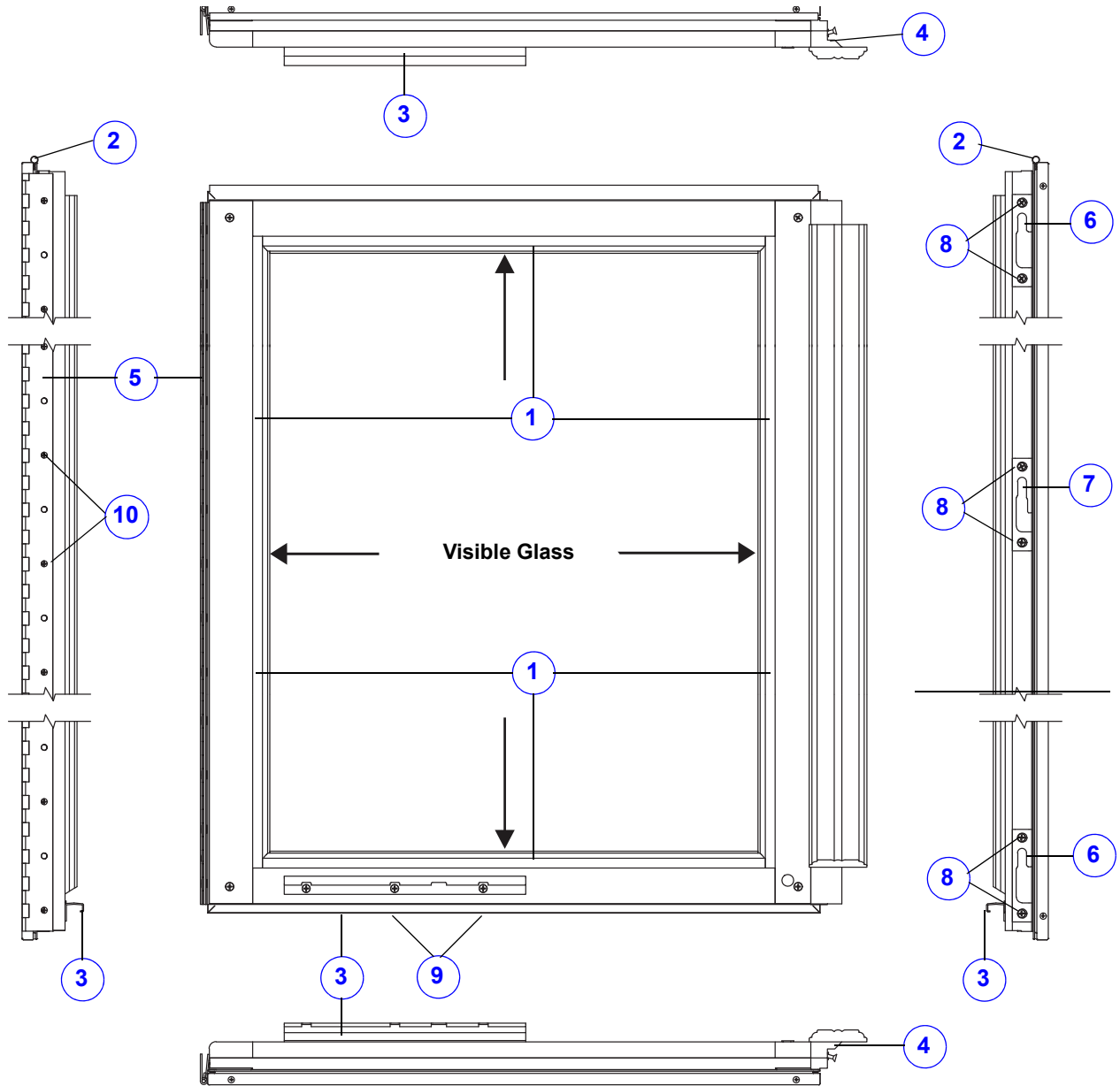

- 1. [Stop](#)
- 2. [Weatherstrip](#)
- 3. [Sash Track](#)
- 4. [Astragal](#)
- 5. [Hinge \(Piano\)](#)
- 6. [Lock Strike \(Top-Bottom\)](#)
- 7. [Lock Strike \(Center\)](#)
- 8. [Screw \(Strikes\)](#)
- 9. [Screw \(Sash Track\)](#)
- 10. [Screw \(Piano Hinge\)](#)

E-Series French Casement Inactive Sash

Sash

Sash Graphic / Detail

Note:

Active and In-Active French Casement sash detail shown. See additional [casement types](#).

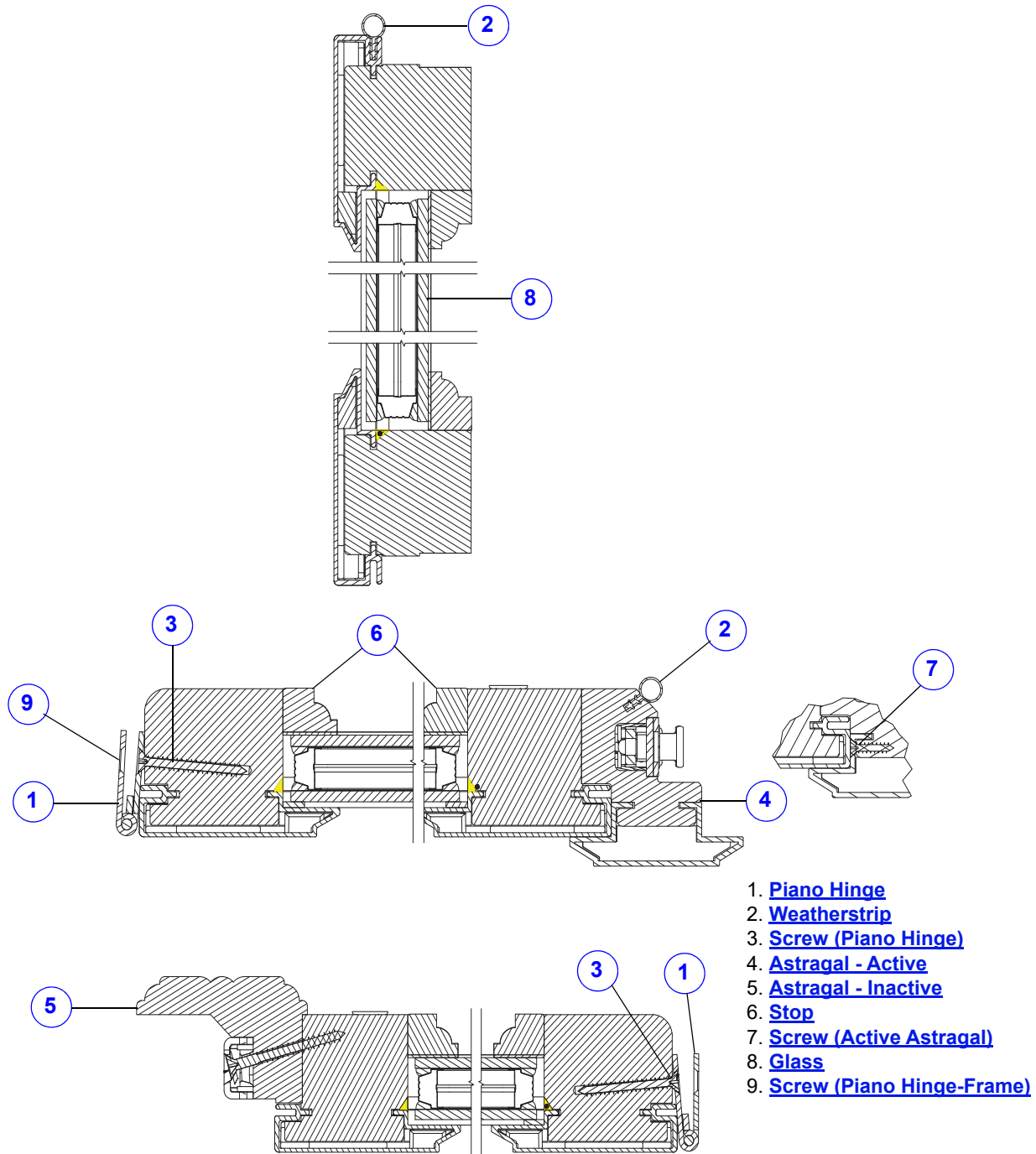

E-Series French Casement Windows (2014 to Present)

Standard Windows

Sash

Sash

Sash

Note:

Replacement sash for windows are made to order and can be configured through iQ+. Current glazings replace previous vintage glazings. Product ID label is located on the head jamb.



TEMPERED
UA
16 CFR 1201.11
ANSI Z97.1-2009
SGCC XXXX
CIG-XX Xmm MM/DD/YR
CAN/CGSB 12.1-M90

Exterior color options:

Interior species/finish/color options:

Glass options (See Logo/Etching Examples):

Low-E4®	Low-E4® HeatLock	Low-E4® SmartSun HeatLock
Low-E4® SmartSun™	Low-E4® Smart-Sun HeatLock	Low-E4® Triple-Pane
Low-E4® Passive Sun	Low-E4® Sun Heat-Lock	Low-E4® Smart-Sun Triple-Pane
Low-E4® Sun 3	Low-E4® HeatLock Tempered	Low-E4® Enhanced Triple-Pane
Low-E4® Tempered	Dual Pane Clear	Low-E4® Smart-Sun Enhanced Triple-Pane
Low-E4® SmartSun Tempered	Cascade	Low-E4® Enhanced Triple-Pane Heat-Lock
Low-E4® Passive Sun Tempered	Fern	Low-E4® Smart-Sun Enhanced Triple-Pane HeatLock
Low-E4® Sun Tempered	Reed	

To order, state:

Product ID (from product label, see [Service Guide 9051877](#))

OR

1. Unit or frame size (FCAX XXXX or frame W x H dimensions)
2. Description of part (Active Sash, Inactive Sash)
3. Sash handing (Right, Left, or Stationary)
4. Exterior color of sash to be replaced
5. Interior wood species/finish/color of sash to be replaced
6. Glazing/Grille type
7. Glass Stop Type (Ovolo, Contemporary)
8. Manufacturing Date

Sash

Sash Parts

Astragal

Note:

Replacement astragals for active and in-active sash are made to order.

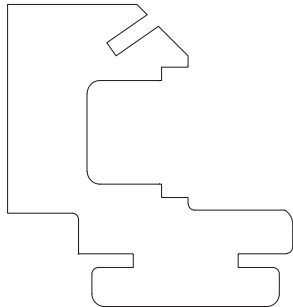

Active

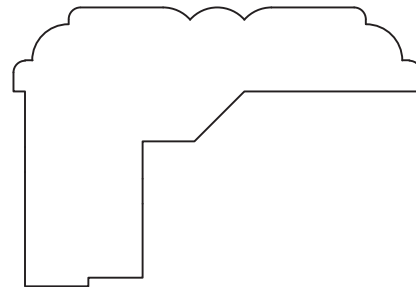

In-Active

To order, state:

Product ID (from product label, see [Service Guide 9051877](#))

OR

1. Unit or frame size (FCAX XXXX or frame W x H dimensions)
2. Description of part (Active Astragal, In-Active Astragal)
3. Sash handing (Right, Left)
4. Interior/Exterior wood species/finish/color of astragal to be replaced

Astragal Screw (Active Astragal)

	Description	Order No.
	#4 X 1/2 PFHSSMS Type AB 18-8 SS	0009884

Weatherstrip

Weatherstrip		Color	Size	Order No.
		White	10 ft (120")	9103912
		Black		9103913
		White	25 ft (300")	9103816
		Black		9103817

E-Series French Casement Windows (2014 to Present)

Standard Windows

Glass

Glass

Glass

Note:

Replacement glass is made to order and can be configured through iQ+. Current glazings replace previous vintage glazings. Product ID label is located on the head jamb. Glass ships with sealant and spacers. See [Accessory Guide 9176386](#).



TEMPERED
16 CFR 1201 II
ANSI Z97.1 2009
SGCC XXXX
CIG-XX Xmm MM/DD/YR
CAN/CGSB 12.1-M90

Exterior color options:

Interior species/finish/color options:

Glass options (See Logo/Etching Examples):

Low-E4®	Low-E4® HeatLock	Low-E4® SmartSun HeatLock
Low-E4® SmartSun™	Low-E4® Smart-Sun HeatLock	Low-E4® Triple-Pane
Low-E4® Passive Sun	Low-E4® Sun Heat-Lock	Low-E4® Smart-Sun Triple-Pane
Low-E4® Sun 3	Low-E4® HeatLock Tempered	Low-E4® Enhanced Triple-Pane
Low-E4® Tempered	Dual Pane Clear	Low-E4® Smart-Sun Enhanced Triple-Pane
Low-E4® SmartSun Tempered	Cascade	Low-E4® Enhanced Triple-Pane Heat-Lock
Low-E4® Passive Sun Tempered	Fern	Low-E4® Smart-Sun Enhanced Triple-Pane HeatLock
Low-E4® Sun Tempered	Reed	

To order, state:

Product ID (from product label, see [Service Guide 9051877](#))

OR

1. Unit or frame size (FCAX XXXX or frame W x H dimensions)
2. Description of part (Glass)
3. Glazing/Grille type
4. Glass Stop Type (Ovolo, Contemporary)
5. Manufacturing Date

Glass

Glass Stops

Stops - Top / Bottom / Side

Note:

Stops (top, bottom and side) are made to order.

To order, state:

Product ID (from product label, see [Service Guide 9051877](#))

OR

1. Description of Part/Size (Stop)
2. Color/Species/Finish
3. Location/Handing (Top, Bottom, Side)
4. Type (Ovolo, Contemporary)
5. Manufacturing Date

Interior species/finish/color options

WOOD SPECIES

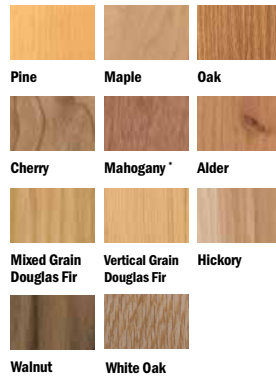

FACTORY-FINISHED INTERIORS



PAINTED OPTIONS



E-Series French Casement Windows (2014 to Present)

Standard Windows

Glass

Glass Parts			
Glazing Tape			
Note: See Accessory Guide 9064542 .			
		Color	Order No.
		Gray	33751RL
Sealant			
		Color	Order No.
		Dove Gray	9164412
Spacer			
		Size	Order No.
		3 x 1/4 x 1/16	9152146

Insect Screens

Insect Screen

Note:

Retractable and standard screens available in fiberglass, aluminum and TruScene® material. Replacement insect screens can be configured in iQ+.

Color/finish options



Species/finish/color options

WOOD SPECIES

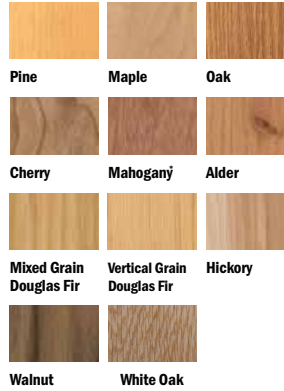

FACTORY-FINISHED INTERIORS



Standard Screen



Retractable Screen

E-Series French Casement Windows (2014 to Present)

Standard Windows

Insect Screens

Insect Screen - Standard Screens

Insect Screen - Standard Screens			
Unit No.		Dimensions (w x h)	Graphic
34	FCAX3430	36 ¹³ / ₃₂ X 31 ¹⁹ / ₃₂	
	FCAX3434	36 ¹³ / ₃₂ X 35 ¹⁹ / ₃₂	
	FCAX3440	36 ¹³ / ₃₂ X 43 ¹⁹ / ₃₂	
	FCAX3446	36 ¹³ / ₃₂ X 49 ¹⁹ / ₃₂	
	FCAX3450	36 ¹³ / ₃₂ X 55 ¹⁹ / ₃₂	
40	FCAX4030	44 ¹³ / ₃₂ X 31 ¹⁹ / ₃₂	
	FCAX4034	44 ¹³ / ₃₂ X 35 ¹⁹ / ₃₂	
	FCAX4040	44 ¹³ / ₃₂ X 43 ¹⁹ / ₃₂	
	FCAX4046	44 ¹³ / ₃₂ X 49 ¹⁹ / ₃₂	
	FCAX4050	44 ¹³ / ₃₂ X 55 ¹⁹ / ₃₂	
48	FCAX4830	52 ¹³ / ₃₂ X 31 ¹⁹ / ₃₂	
	FCAX4834	52 ¹³ / ₃₂ X 35 ¹⁹ / ₃₂	
	FCAX4840	52 ¹³ / ₃₂ X 43 ¹⁹ / ₃₂	
	FCAX4846	52 ¹³ / ₃₂ X 49 ¹⁹ / ₃₂	
	FCAX4850	52 ¹³ / ₃₂ X 55 ¹⁹ / ₃₂	
50	FCAX5030	56 ¹³ / ₃₂ X 31 ¹⁹ / ₃₂	
	FCAX5034	56 ¹³ / ₃₂ X 35 ¹⁹ / ₃₂	
	FCAX5040	56 ¹³ / ₃₂ X 43 ¹⁹ / ₃₂	
	FCAX5046	56 ¹³ / ₃₂ X 49 ¹⁹ / ₃₂	
	FCAX5050	56 ¹³ / ₃₂ X 55 ¹⁹ / ₃₂	

Insect Screens

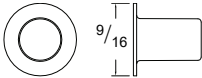
Insect Screen Parts		
Grommet		
Note: Used with standard and wood veneer screen.		
		Order No. 0009220

E-Series French Casement Windows (2014 to Present)

Standard Windows

Grilles

Grilles

Note:

Replacement sash with permanently applied grilles and finelight grilles can be configured in iQ+. Replacement removable interior grilles can be configured in iQ+. Removable grilles are only available in 7/8" profile.

Exterior color/finish options



ANNODIZED FINISHES



Interior species/finish/color options

WOOD SPECIES

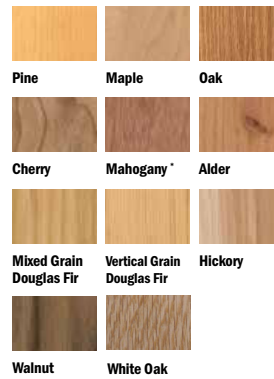

FACTORY-FINISHED INTERIORS

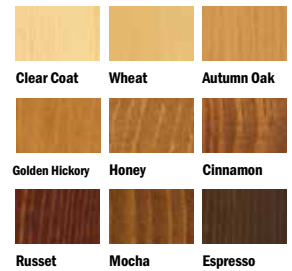

PAINTED OPTIONS



Painted options available with pine and maple only.

Grilles

Grille Options

Note:

Replacement sash with permanently applied grilles and finelight grilles can be configured in iQ+. Replacement removable interior grilles can be configured in iQ+. Removable grilles are only available in 7/8" profile.

Types



Full Divided Light

Give any window an authentic look with full divided light grilles that are permanently applied to the interior and exterior of your window with a spacer between the glass.



Simulated Divided Light

An economical solution with traditional beauty, our Simulated Divided Light features fixed exterior and interior grilles without an internal spacer.



Removable Interior Wood Grilles

Our removable wood grilles are installed on the interior surface. They are available with an optional surround and an optional permanently applied exterior grille.



Finelight™ Grilles-Between-the-Glass

Aluminum grilles conveniently placed between two panes of glass make the glass easy to clean inside and out.

Profiles

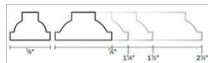

Interior Wood: Ovolo (Colonial)

Widths:

- 5/8"
- 7/8"
- 1 1/8"
- 1 1/2"
- 2 1/4"

Available with:

- Full Divided Light
- Simulated Divided Light

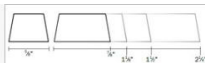

Interior Wood: Contemporary

Widths:

- 5/8"
- 7/8"
- 1 1/8"
- 1 1/2"
- 2 1/4"

Available with:

- Full Divided Light
- Simulated Divided Light

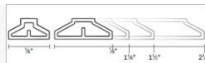

Exterior Aluminum: Chamfer

Widths:

- 5/8"
- 7/8"
- 1 1/8"
- 1 1/2"
- 2 1/4"

Available with:

- Full Divided Light
- Simulated Divided Light
- Removable Interior Wood with Optional Permanently Applied Exterior Grille

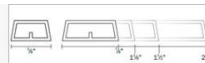

Exterior Aluminum: Contemporary

Widths:

- 5/8"
- 7/8"
- 1 1/8"
- 1 1/2"
- 2 1/4"

Available with:

- Full Divided Light
- Simulated Divided Light
- Removable Interior Wood with Optional Permanently Applied Exterior Grille

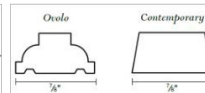

Removable Interior Wood Grilles

Ovolo or Contemporary profiles in 7/8" width

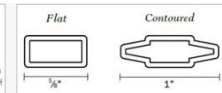

Finelight Grille Profiles and Widths

Flat or Contoured profiles in 5/8" or 1" widths

Patterns

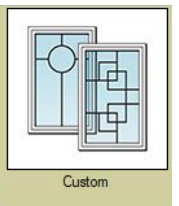
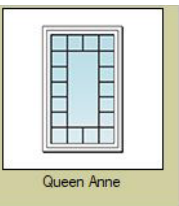
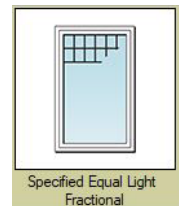
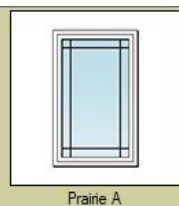
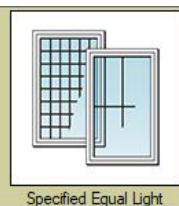
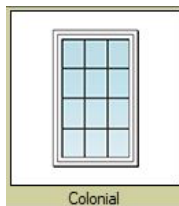

E-Series French Casement Windows (2014 to Present)

Standard Windows

Grilles

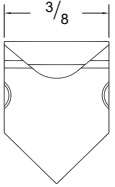
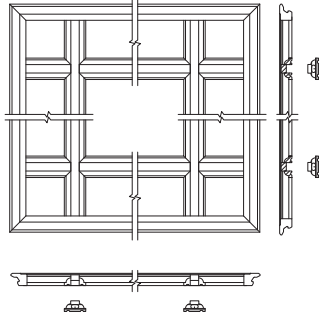
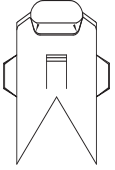
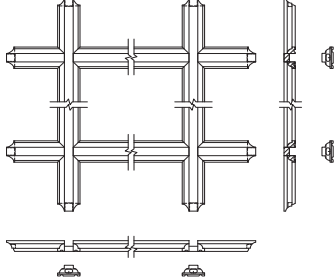
Interior Grille Parts				
Clip - Surround				
Note: Used with framed removable grilles.				
		<table border="1" style="width: 100%; border-collapse: collapse;"> <tr> <th style="text-align: left; padding: 5px;">Order No.</th> </tr> <tr> <td style="padding: 5px;">0004900</td> </tr> </table>	Order No.	0004900
Order No.				
0004900				
Clip - Knocked Down				
Note: Used with knocked down removable grilles.				
		<table border="1" style="width: 100%; border-collapse: collapse;"> <tr> <th style="text-align: left; padding: 5px;">Order No.</th> </tr> <tr> <td style="padding: 5px;">0004901</td> </tr> </table>	Order No.	0004901
Order No.				
0004901				

Hardware

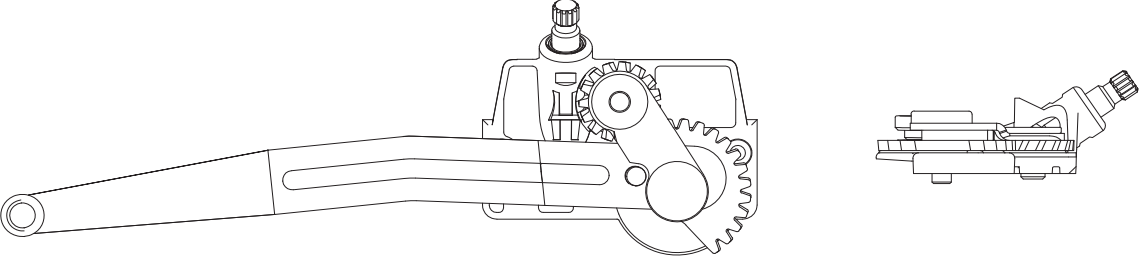
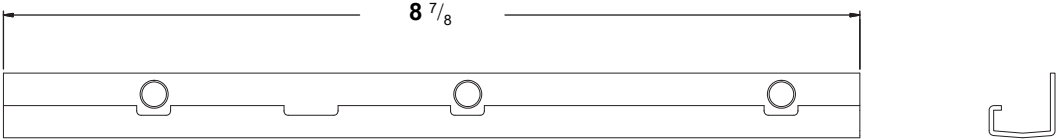
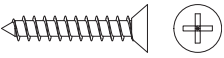
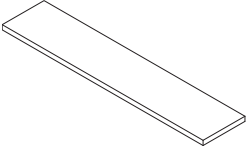
Operator			
Note: Stainless Steel.			
 <p>French Casement Operator</p>			
Operator / > 21"			
		LH	RH
		0011828	0011829
Track / Operator			
			
			Order No.
			0007673
Screw / Operator Track			
	Description	Finish	Order No.
	#7 x 7/8" PFHSMS Type AB Stainless Steel	Stainless Steel	0015746
Shim / Operator			
			Order No.
		0067498	
Screw / Shim			
	Description	Finish	Order No.
	#8 x 1" PFHSMS	Z & Y	0013396

E-Series French Casement Windows (2014 to Present)

Standard Windows

Hardware

Hinge - Piano

Hinge - Piano

Note:

Secures to sash and frame.

To order, state:

Product ID (from product label, see [Service Guide 9051877](#))

OR

1. Unit height
2. Description of part (Piano Hinge 2")
3. Hinge color (Black, Stainless Steel)

Screw - Piano Hinge

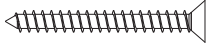
	Description	Order No.
	#7 X 1 1/4 SS	0027959

Screw - Piano Hinge (Frame)

	Description	Order No.
	#7 X 5/8 SS	0015331

Operator Cover

Operator Cover

Note:

Handed as the unit is handed unless piano hinges are used. Piano hinges are "standard" on French Casement units.

		Order No.	
	Color	LH RH (Piano)	RH LH (Piano)
	Black	9105294	9105295
	Gold	9105292	9105293
	Bronze	9105290	9105291
	White	9105288	9105289
	Antique Brass	9105306	9105307
	Bright Brass	9105296	9105297
	Satin (Brushed) Chrome	9105302	9105303
	Bright (Polished) Chrome	9105304	9105305
	Bronze	9105290	9105291
	Oil Rubbed Bronze	9105298	9105299
Pewter	9105300	9105301	

Hardware

Handles			
Folding Handle (Crank)			
		Finish	Order No.
		Black	0007663
		Gold	0007662
		Bronze	0007661
		White	0007660
		Antique Brass	0007669
		Bright Brass	0007664
		Satin Chrome	0007667
		Bright Chrome	0007668
		Oil Rubbed Bronze	0007665
		Pewter	0007666
Handle Assembly			
		Finish	Standard
		Black	0013784
		Brass	0013785
		Bronze	0013786
		White	0013788
		Antique Brass	0013782
		Bright Chrome	0013783
		Satin Chrome	0013787
Temporary Handle - Operator			
			Order No.
			0007896

E-Series French Casement Windows (2014 to Present)

Standard Windows

Hardware

Locks and Lock Components

Lock Gear



Note:

Unit width $\leq 48"$ uses $8 \frac{5}{8}"$ lock extension (9167996).

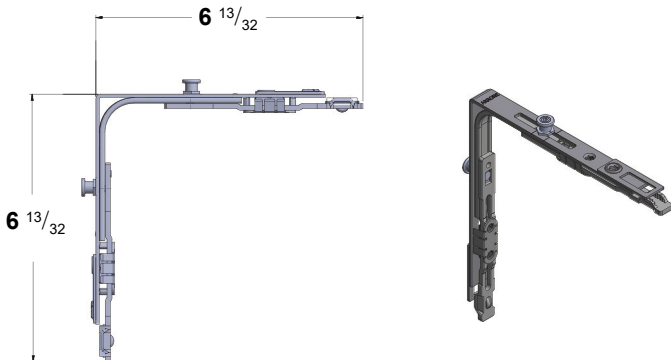
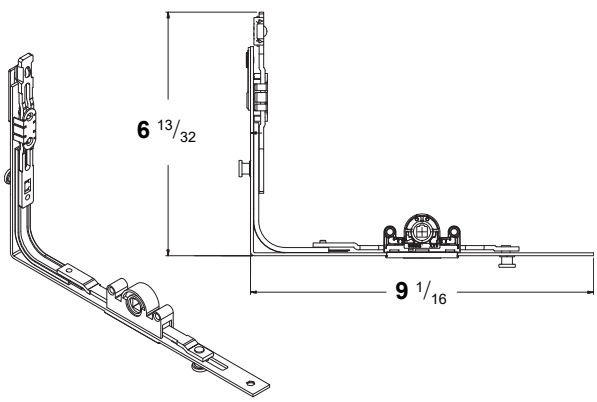
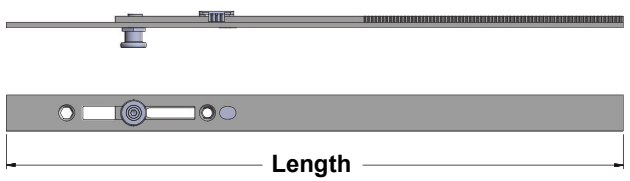
Unit width $>48"$ uses $10 \frac{5}{8}"$ lock extension (9167997).

	Type	Length (Horizontal)	Order No.
	Upper Gear	$6 \frac{13}{32}$	9167991
	Lower Gear	$9 \frac{1}{16}$	9167990
	Extension	$6 \frac{7}{8}$	9167996
		$8 \frac{7}{8}$	9167997

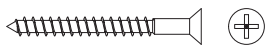
Screw - Lock

	Description	Type	Order No.
	4.2 x 35 Self-Drilling	Stile Screw	9183988
	4.0 x 32MM Self-Drilling	Rail Screw	0205690

Hardware

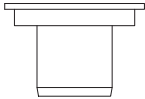
Cover - Groove			
		Type	Order No.
		Short	0208537

Lock Linkage			
Note: Need to specify unit height and Product ID.			
		Order No.	
		By description	

Lock Strike Ref. No. 6 & 7 page 11			
Note: Secures to inactive sash.			
		Top (Astragal) Bottom (Astragal) Sill	Center (Astragal)
		9170370	9167988

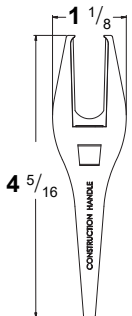
Temporary Handle - Lock			
		Order No.	
		0008949	

E-Series French Casement Windows (2014 to Present)

Standard Windows

Hardware

Optional Hardware

Sleeve Magnet			
	Note: Used with Verilock.	Finish	Order No.
		White	0015968
		Brown	0015967

Hardware

Fasteners

Screw - Sash Limiter

	Description	Order No.
	#8 X 3/4 PPHSMS Type AB 18-8 SS	0033736

Screw - Sill Stop

	Description	Order No.
	#8 X 2 1/8 PFHSMS Type AB Z & Y	9105309

Frame - Side Jambs

Note:

French casement unit shown. See latest [details](#).

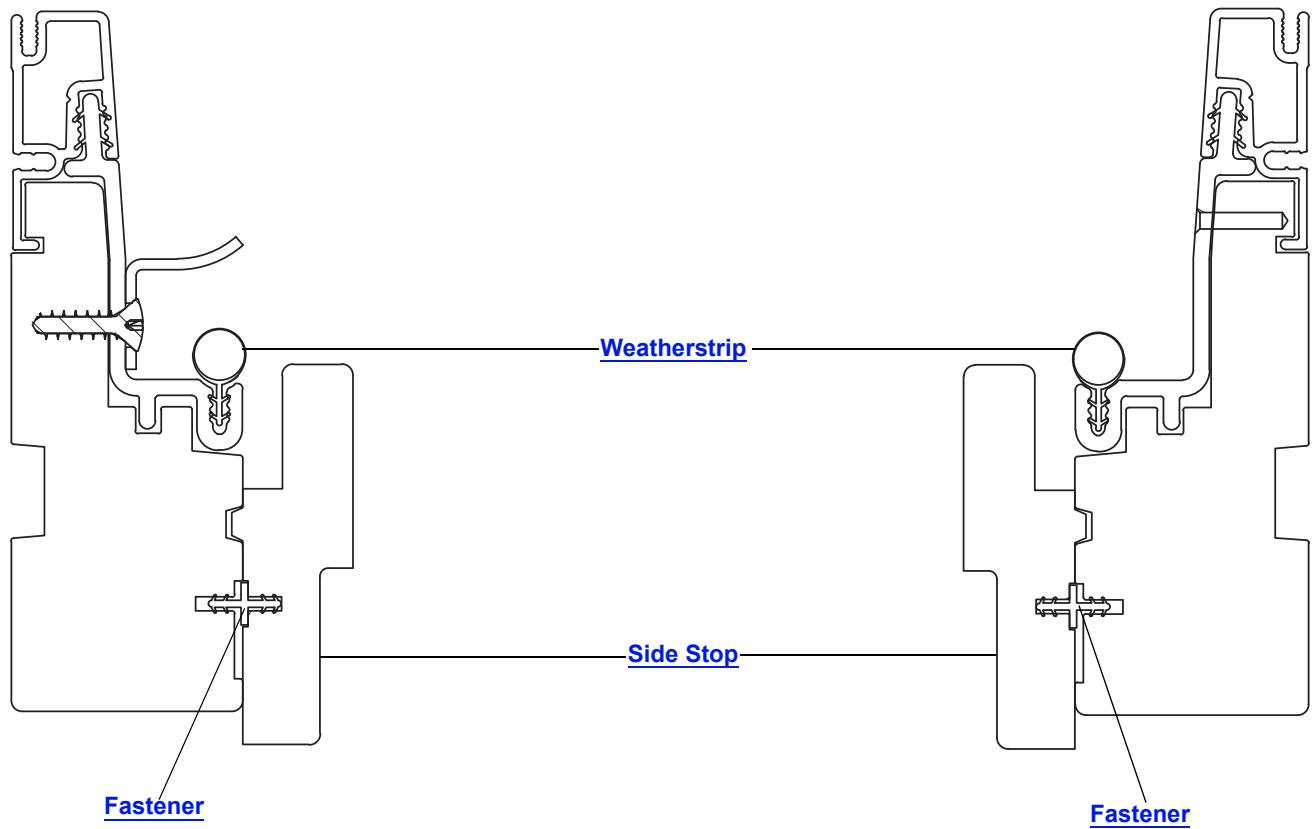

French Casement Frame (Side Jambs) Assembly

Frames

Frame - Head Jamb and Sill

Note:
French casement unit shown. See latest [details](#).

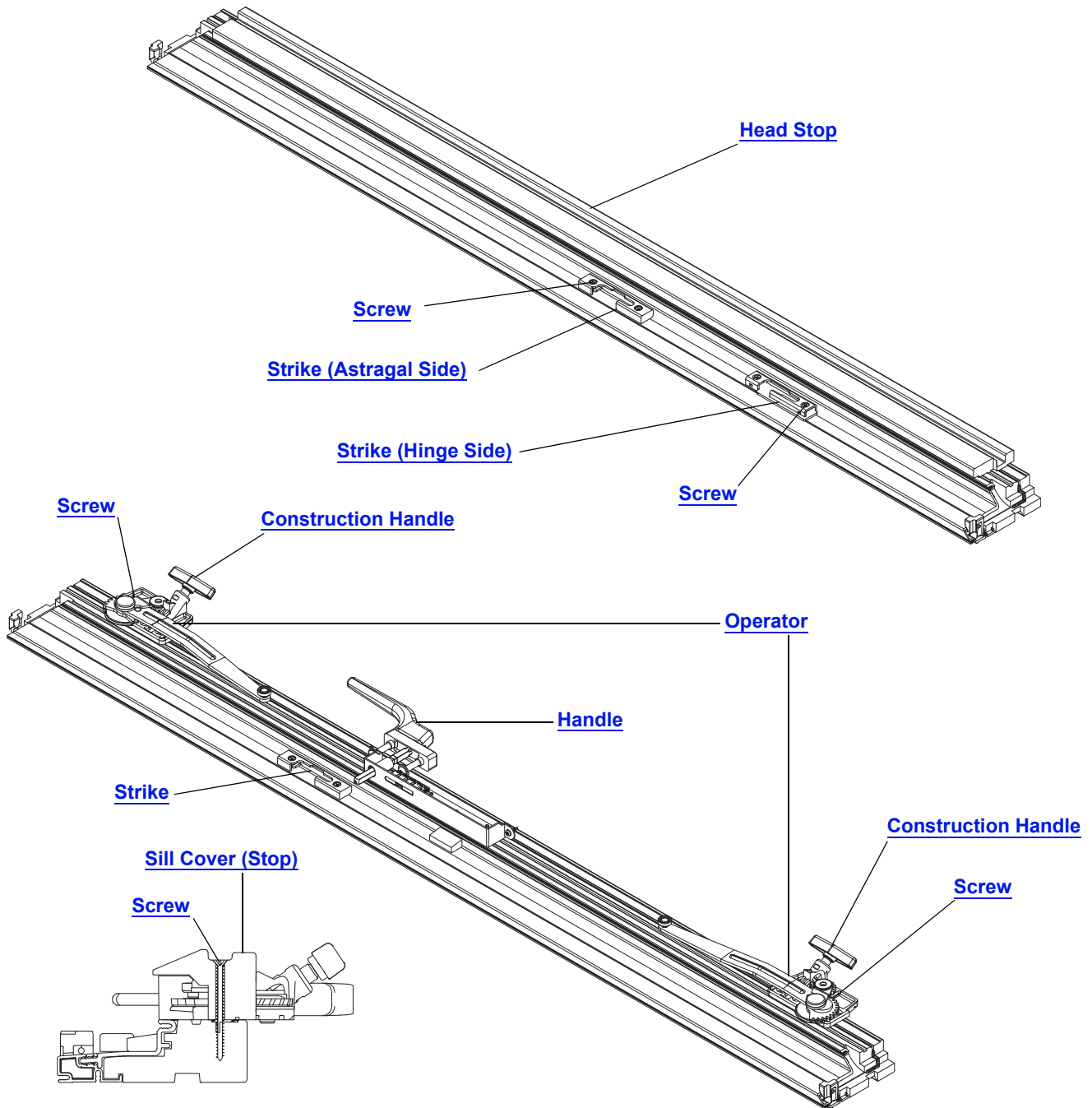

French Casement Frame (Head and Sill) Assembly

E-Series French Casement Windows (2014 to Present)

Standard Windows

Frames

Frame

Note:

Replacement frames are made to order and can be configured through iQ+. Replacement frames ship with hardware.

To order, state:

Product ID (from product label, see [Service Guide 9051877](#))

OR

1. Description of Part/Size (FCAX XXXX or frame W X H dimensions)
2. Colors/Species/Finish
3. Manufacturing Date

Exterior color/finish options



ANNODIZED FINISHES



Interior species/finish/color options

WOOD SPECIES

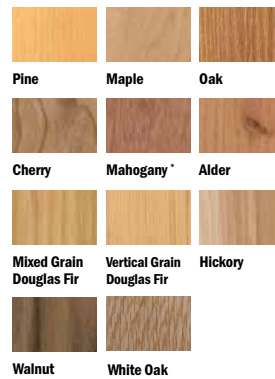

FACTORY-FINISHED INTERIORS

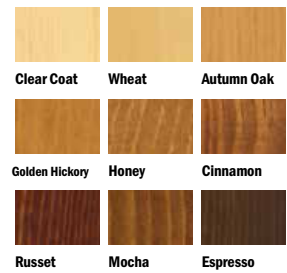

PAINTED OPTIONS



Frames

Stops

Stops - Head / Sill / Side

Note:

Stops (head, sill and side) are made to order.

To order, state:

Product ID (from product label, see [Service Guide 9051877](#))

OR

1. Description of Part/Size (Stop)
2. Color/Species/Finish
3. Location/Handing (Head, Sill, Lock Jamb, Hinge Jamb, LH, RH)
4. Manufacturing Date

Interior species/finish/color options

WOOD SPECIES



Pine Maple Oak



Cherry Mahogany Alder



Mixed Grain Douglas Fir Vertical Grain Douglas Fir Hickory



Walnut White Oak

FACTORY-FINISHED INTERIORS



Clear Coat Wheat Autumn Oak



Golden Hickory Honey Cinnamon



Russet Mocha Espresso

PAINTED OPTIONS

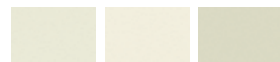

White Birch Bark Primed (for paint)



Canvas Sandtone Terratone



Forest Green Dark Bronze Dove Gray



Prairie Grass Red Rock Cocoa Bean



Black

Painted options available with pine and maple only.

E-Series French Casement Windows (2014 to Present)

Standard Windows

Frames

Weatherstrip			
Weatherstrip			
		Size	Order No.
		10 ft (120")	9103914
		25 ft (300")	9103915

Frame Parts			
Fastener			
		Size	Order No.
		3"	000CFS3
		6"	000CFS6
		34"	00CFS34
		55"	00CFS55
	96"	00CFS96	

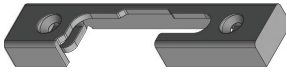
Strike			
		Type	Order No.
		Head (Astragal Side) Sill	9170370
		Head (Hinge Side)	9170371

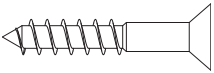
Screw - Strike			
		Finish	Order No.
		Unfinished	0205692

Frames
