

What's in This Section

Parts Illustration	3
Colors - Exterior	4
Colors/Species/Finishes - Interior	5
Unit Sizes	6
Standard and Custom Window Sizes	6
E-Series Product Label	6
Unit Size Chart - Standard Windows	7
Unit Size Chart - Picture & Transom Windows	8
Product History	9
Product History	9
Sash	10
Sash Size Table	10
Sash Graphic	13
Sash	14
Weatherstrip	15
Glass	16
Glass	16
Glass Stops	17
Glass Parts	18
Insect Screens	19
Insect Screen	19
Insect Screen - Standard Screens	20
Insect Screen Parts	22
Grilles	23
Grilles	23
Grille Options	24
Interior Grille Parts	25
Hardware	26
Operator > 21"	26
Operator < 21" (Split Arm)	27
Operator > 20" Egress	28
Operator / Piano Hinge	29
Hinge - Piano	30
Hinge Components	31
Hardware Packs	32
Operator Covers	32
Handles	33

Locks and Lock Components	34
Optional Hardware	36
Fasteners	36
Frames	37
Frame Graphic - Standard Windows	37
Frame	38
Stops	39
Weatherstrip	40
Frame Parts	40
Installation Material	41

E-Series Casement Windows (2011 to Present)

Standard Windows

Parts Illustration

Parts Illustration

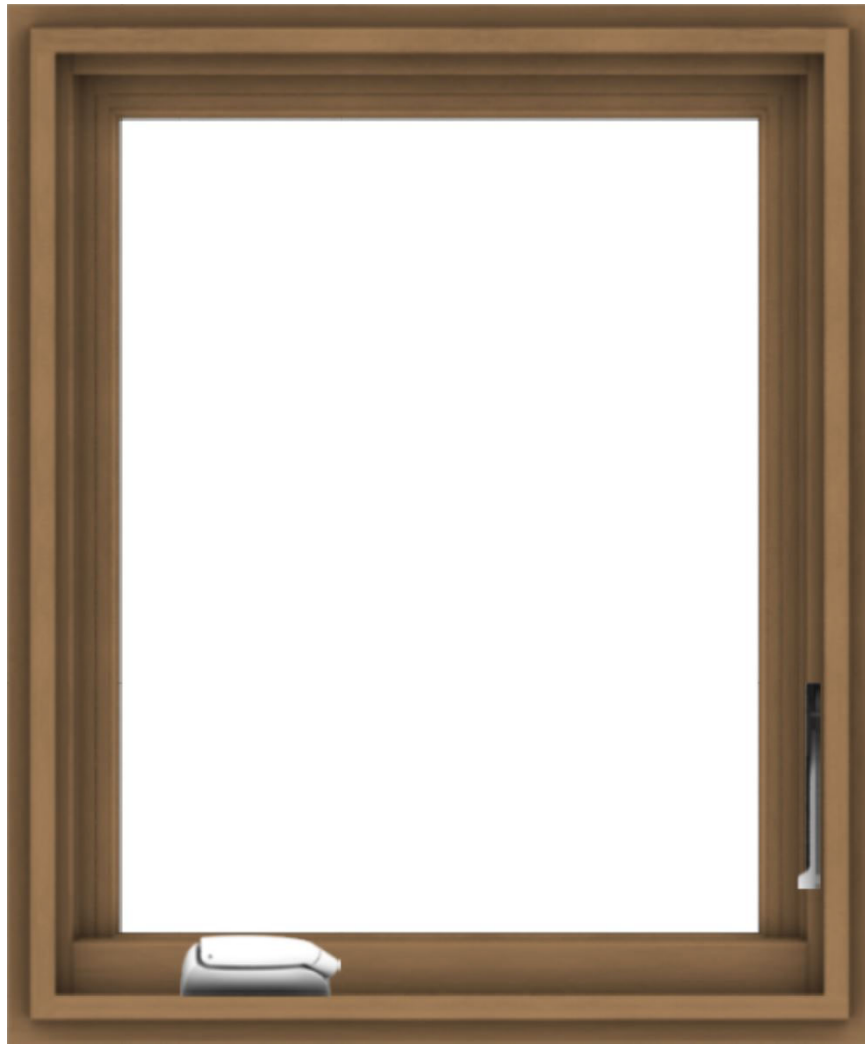

E-Series Casement Window Unit Parts

Unit viewed from interior

Parts Illustration

Colors - Exterior

Note:
(*) Anodized Finishes

			Colony White	White	Abalone	Balsa White
			Canvas	Maple Syrup	Harvest Gold	Prairie Grass
Flagstone	Sandtone	Pebble Tan	Carmel	Terratone	Hot Chocolate	Bourbon
Acorn	Coffee Bean	Cocoa Bean	Sierra Bronze	Dark Bronze	Clay Canyon	Red Rock
Cardinal	Bing Cherry	Fire Engine Red	Cinnamon Toast	Olive	Sage	Billiard Green
Moss	Forest Green	Mallard Green	Spearmint	Aquamarine	Patina	Sky Blue
Country Blue	Blue Denim	Watercolor Blue	Caribbean Blue	Slate	Moody Blue	Stormy Blue
Dove Gray	Harbor Mist	Yorktown Pewter	Smokey Gray	Mystic Gray	Dark Ash	Black
Light Bronze*	Champagne*	Clear Anodized*	Black	Dark Bronze*	Copper*	Medium Bronze*

Colors/Species/Finishes - Interior

Species Interior Options



Pine



Mixed Grain
Douglas Fir



Oak



Maple

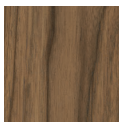

Walnut



Alder



Hickory



Mahogany



Vertical Grain
Douglas Fir



Cherry



White Oak

Stained Interior Options



Clear Coat



Wheat



Autumn Oak



Golden Hickory



Honey



Cinnamon

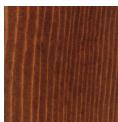

Russet



Mocha

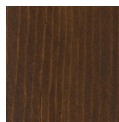

Espresso

Painted Interior Options

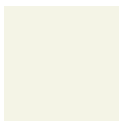

White

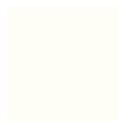

Birch Bark



Primed



Canvas



Sandtone



Terratone



Forest Green



Dark Bronze



Dove Gray



Prairie Grass



Red Rock



Cocoa Bean



Black



Anodized Silver ¹

Unit Sizes

Standard and Custom Window Sizes

Note:

E-Series Casement Windows are available in standard sizes (see standard size charts, [page 6](#)). Replacement parts for some standard windows can be ordered using the numbers listed in this catalog. Many replacement parts for standard windows are made to order. These items are ordered using the Product ID found on the identification label and a description of the part needed. See [Service Guide 9051877](#).

E-Series Casement Windows are also available in custom sizes in 1/8" increments between the smallest and the largest standard sizes. Most replacement parts for custom-sized windows are made to order and can be ordered with the Product ID found on the identification label and a description of the part needed. See [Service Guide 9051877](#).

E-Series Product Label

Note:

Every E-Series Casement Window will have an identification label or glass etching containing a unique Product ID. The Product ID on E-Series Casement Windows will be located at the top of the window frame or etched into the glass. See [Service Guide 9051877](#). The Product ID may be up to 14 digits long (excluding hyphens), depending on the age of the unit. Replacement parts will also get their own unique Product ID. When ordering replacement parts, providing the Product ID ensures that replacement parts match the specifications.

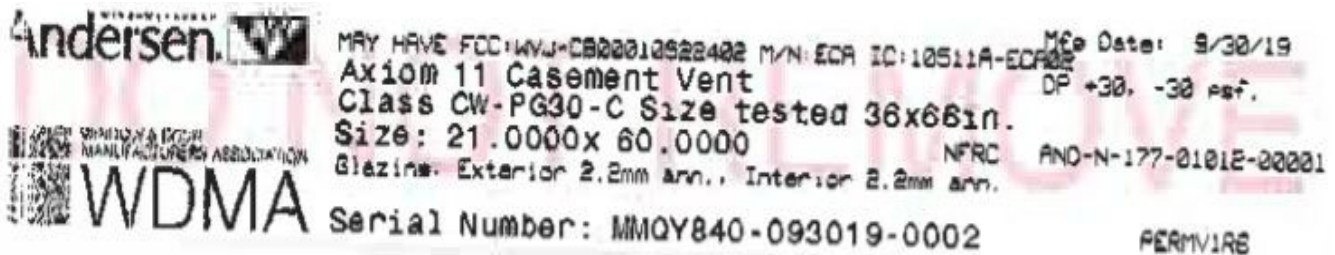

E-Series Casement Windows (2011 to Present)

Standard Windows

Unit Sizes

Unit Size Chart - Standard Windows

Note:

F.S. refers to overall outside-to-outside frame. R.O. refers to rough opening. See latest [Size Grid](#).

Casement Window Sizes

	1' 6 1/4"	1' 8 1/2"	2' 0 1/2"	2' 4 1/2"	2' 6 1/2"	2' 8 1/2"	3' 0 1/2"
	1' 5 3/4"	1' 8"	2' 0"	2' 4"	2' 6"	2' 8"	3' 0"
	11 5/8"	1' 1 7/8"	1' 5 7/8"	1' 9 7/8"	1' 11 7/8"	2' 1 7/8"	2' 5 7/8"
	R.O.	R.O.	R.O.	R.O.	R.O.	R.O.	R.O.
	V.G.	V.G.	V.G.	V.G.	V.G.	V.G.	V.G.
2' 0 1/2"							
2' 6"							
2' 8"							
3' 0"							
3' 4 1/2"							
4' 0"							
4' 6 1/2"							
5' 0"							
5' 6"							
6' 0 1/2"							

NOTES
 † These units meet or exceed the following dimensions: Clear Opening Area 5.7 sq. ft., Clear Opening Width 20", Clear Opening Height 24" and 44" maximum floor to sill height (with standard 6'10-1/2" structural header height). Local codes may differ. Verify egress requirements with your local building code official.
 Units ≤ 24" Actual Frame Width (AFW) will receive hinges only (no clip or friction arm).
 Units > 24" AFW and ≤ 30" AFW receive clip only.
 Units > 30" AFW receive (2) 14" friction arms.
 If glass is positioned within 18" of the finished floor, safety tempered glass may be required. Local codes may differ. Verify tempered glass requirements with your local building code official.
 Use structural joining material when necessary or required by code.
 The light patterns illustrated apply to rectangular removable interior wood grilles, Full Divided Light, Simulated Divided Light, Decorelle 100, 150 and 400 and Finelight™ Grilles-Between-the-Glass. All removable interior wood grilles will be installed in the units unless otherwise specified.
 For a metric conversion in millimeters, multiply dimensions in inches by 25.4.
 R.O. = Rough Opening
 F.S. = Frame Size
 V.G. = Visible Glass
 A piano hinge and sash limiting device is standard on 2860, 3056 and 3060 casement units.

Vent Layout as Viewed From Exterior

Left Stationary Right

FORMULA FOR COMBINATION WINDOWS
 The overall frame dimension (both width and height) is equal to the sum of the individual unit frame dimensions plus joining material dimension(s).
 The overall rough opening (both width and height) is equal to the overall frame dimensions plus 1/4" on all sides.
 Any unit within each combination can be operating or stationary.

Joined Casement Combinations	2-Wide		3-Wide		4-Wide		5-Wide	
	Rough Opening Width	Frame Width	Rough Opening Width	Frame Width	Rough Opening Width	Frame Width	Rough Opening Width	Frame Width
Single Unit Frame Width								
1'-5 3/4"	3'-0"	2'-11 1/2"	4'-5 3/4"	4'-5 1/4"	5'-11 1/2"	5'-11"	7'-5 1/4"	7'-4 3/4"
1'-8"	3'-4 1/2"	3'-4"	5'-0 1/2"	5'-0"	6'-8 1/2"	6'-8"	8'-4 1/2"	8'-4"
2'-0"	4'-0 1/2"	4'-0"	6'-0 1/2"	6'-0"	8'-0 1/2"	8'-0"	10'-0 1/2"	10'-0"
2'-4"	4'-8 1/2"	4'-8"	7'-0 1/2"	7'-0"	9'-4 1/2"	9'-4"	11'-8 1/2"	11'-8"
2'-6"	5'-0 1/2"	5'-0"	7'-6 1/2"	7'-6"	10'-0 1/2"	10'-0"	12'-6 1/2"	12'-6"
2'-8"	5'-4 1/2"	5'-4"	8'-0 1/2"	8'-0"	10'-8 1/2"	10'-8"	13'-4 1/2"	13'-4"
3'-0"	6'-0 1/2"	6'-0"	9'-0 1/2"	9'-0"	12'-0 1/2"	12'-0"	15'-0 1/2"	15'-0"

E-Series Casement Standard Window Unit Sizes

Unit Sizes

Unit Size Chart - Picture & Transom Windows

Note:

F.S. refers to overall outside-to-outside frame. R.O. refers to rough opening. See latest [Size Grid](#).

Casement Picture Window Sizes

	3' 0 1/2"	3' 4 1/2"	4' 0 1/2"	5' 0 1/2"	6' 0 1/2"
	3' 0"	3' 4"	4' 0"	5' 0"	6' 0"
3' 6 1/2" R.O. 3' 4 1/2" F.S.					
	SCA3034	SCA3434	SCA4034	SCA5034	SCA6034
4' 0 1/2" R.O. 4' 0" F.S.					
	SCA3040	SCA3440	SCA4040	SCA5040	SCA6040
4' 6 1/2" R.O. 4' 6" F.S.					
	SCA3046	SCA3446	SCA4046	SCA5046	SCA6046
5' 0 1/2" R.O. 5' 0" F.S.					
	SCA3050	SCA3450	SCA4050	SCA5050	SCA6050
5' 6 1/2" R.O. 5' 6" F.S.					
	SCA3056	SCA3456	SCA4056	SCA5056	SCA6056
6' 0 1/2" R.O. 6' 0" F.S.					
	SCA3060	SCA3460	SCA4060	SCA5060	SCA6060

NOTES

If glass is positioned within 18" of the finished floor, safety/tempered glass may be required. Local codes may differ. Verify tempered glass requirements with your local building code official.

Use structural joining material when necessary or required by code.

The light patterns illustrated apply to rectangular removable interior wood grilles, Full Divided Light, Simulated Divided Light, Decorelle 100, 150 and 400 and Finelight™ Grilles-Between-the-Glass. All removable interior wood grilles will be installed in the units unless otherwise specified.

For a metric conversion in millimeters, multiply dimensions in inches by 25.4.

FORMULA FOR COMBINATION WINDOWS

The overall frame dimension (both width and height) is equal to the sum of the individual unit frame dimensions plus joining material dimension(s).

The overall rough opening (both width and height) is equal to the overall frame dimensions plus 1/4" on all sides.

Any unit within each combination can be operating or stationary.

Casement Transom Window Sizes

	1' 6 1/4"	1' 8 1/2"	2' 0 1/2"	2' 4 1/2"	2' 6 1/2"	2' 8 1/2"	3' 0 1/2"	3' 4 1/2"	4' 0 1/2"
	1' 5 3/4"	1' 8"	2' 0"	2' 4"	2' 6"	2' 8"	3' 0"	3' 4"	4' 0"
1' 6 1/4" R.O. 1' 2 1/4" F.S.									
	SCA15 3/4x12	SCA1812	SCA2012	SCA2412	SCA2612	SCA2812	SCA3012	SCA3412	SCA4012
1' 8 1/4" R.O. 1' 4 1/4" F.S.									
	SCA15 3/4x14	SCA1814	SCA2014	SCA2414	SCA2614	SCA2814	SCA3014	SCA3414	SCA4014
1' 10 1/4" R.O. 1' 5 3/4" F.S.									
	SCA15 3/4x15 3/4	SCA1815 3/4	SCA2015 3/4	SCA2415 3/4	SCA2615 3/4	SCA2815 3/4	SCA3015 3/4	SCA3415 3/4	SCA4015 3/4
1' 12 1/4" R.O. 1' 8 1/4" F.S.									
	SCA15 3/4x18	SCA1818	SCA2018	SCA2418	SCA2618	SCA2818	SCA3018	SCA3418	SCA4018

FOR WINDOWS GREATER THAN 30 SQUARE FEET OR RATED HIGHER THAN PG50, ONE OF THESE THREE INSTALLATION METHODS IS REQUIRED:
 A) THROUGH THE JAMB B) ALUMINUM INSTALLATION FLANGE OR C) INSTALLATION CLIPS.
 ADDITIONAL CUSTOM SIZES ARE AVAILABLE. CONTACT YOUR LOCAL SUPPLIER FOR MORE INFORMATION. DRAWINGS ARE NOT TO SCALE.

E-Series Casement Picture Window Unit Sizes

E-Series Casement Windows (2011 to Present)

Standard Windows

Product History

Product History

- 2022** White Oak introduced
- 2022** Stormwatch® (not shown in catalog) discontinued. See [Bulletin 80-21](#) for more detail.

Sash

Sash Size Table

Note:

Sash shown is Venting Casement. Overall Sash is measured outside edge to outside edge of frame.

Sash Size Table

Unit No.		Sash Dimensions (w x h)	Visible Glass Dimensions (w x h)	Graphic
15 3/4	CAX1520	16 1/4 x 22 1/2	11 5/8 x 17 7/8	
	CAX1526	16 1/4 x 28 1/2	11 5/8 x 23 7/8	
	CAX1528	16 1/4 x 30 1/2	11 5/8 x 25 7/8	
	CAX1530	16 1/4 x 34 1/2	11 5/8 x 29 7/8	
	CAX1534	16 1/4 x 38 1/2	11 5/8 x 33 7/8	
	CAX1540	16 1/4 x 46 1/2	11 5/8 x 41 7/8	
	CAX1546	16 1/4 x 52 1/2	11 5/8 x 47 7/8	
	CAX1550	16 1/4 x 58 1/2	11 5/8 x 53 7/8	
	CAX1556	16 1/4 x 64 1/2	11 5/8 x 59 7/8	
	CAX1560	16 1/4 x 70 1/2	11 5/8 x 65 7/8	
18	CAX1820	18 1/2 x 22 1/2	13 7/8 x 17 7/8	
	CAX1826	18 1/2 x 28 1/2	13 7/8 x 23 7/8	
	CAX1828	18 1/2 x 30 1/2	13 7/8 x 25 7/8	
	CAX1830	18 1/2 x 34 1/2	13 7/8 x 29 7/8	
	CAX1834	18 1/2 x 38 1/2	13 7/8 x 33 7/8	
	CAX1840	18 1/2 x 46 1/2	13 7/8 x 41 7/8	
	CAX1846	18 1/2 x 52 1/2	13 7/8 x 47 7/8	
	CAX1850	18 1/2 x 58 1/2	13 7/8 x 53 7/8	
	CAX1856	18 1/2 x 64 1/2	13 7/8 x 59 7/8	
	CAX1860	18 1/2 x 70 1/2	13 7/8 x 65 7/8	

E-Series Casement Windows (2011 to Present)

Standard Windows

Sash

Sash Size Table			
Unit No.	Sash Dimensions (w x h)	Visible Glass Dimensions (w x h)	Graphic
20	CAX2020	22 1/2 x 22 1/2	17 7/8 x 17 7/8
	CAX2026	22 1/2 x 28 1/2	17 7/8 x 23 7/8
	CAX2028	22 1/2 x 30 1/2	17 7/8 x 25 7/8
	CAX2030	22 1/2 x 34 1/2	17 7/8 x 29 7/8
	CAX2034	22 1/2 x 38 1/2	17 7/8 x 33 7/8
	CAX2040	22 1/2 x 46 1/2	17 7/8 x 41 7/8
	CAX2046	22 1/2 x 52 1/2	17 7/8 x 47 7/8
	CAX2050	22 1/2 x 58 1/2	17 7/8 x 53 7/8
	CAX2056	22 1/2 x 64 1/2	17 7/8 x 59 7/8
	CAX2060	22 1/2 x 70 1/2	17 7/8 x 65 7/8
24	CAX2420	26 1/2 x 22 1/2	21 7/8 x 17 7/8
	CAX2426	26 1/2 x 28 1/2	21 7/8 x 23 7/8
	CAX2428	26 1/2 x 30 1/2	21 7/8 x 25 7/8
	CAX2430	26 1/2 x 34 1/2	21 7/8 x 29 7/8
	CAX2434	26 1/2 x 38 1/2	21 7/8 x 33 7/8
	CAX2440	26 1/2 x 46 1/2	21 7/8 x 41 7/8
	CAX2446	26 1/2 x 52 1/2	21 7/8 x 47 7/8
	CAX2450	26 1/2 x 58 1/2	21 7/8 x 53 7/8
	CAX2456	26 1/2 x 64 1/2	21 7/8 x 59 7/8
	CAX2460	26 1/2 x 70 1/2	21 7/8 x 65 7/8
26	CAX2620	28 1/2 x 22 1/2	23 7/8 x 17 7/8
	CAX2626	28 1/2 x 28 1/2	23 7/8 x 23 7/8
	CAX2628	28 1/2 x 30 1/2	23 7/8 x 25 7/8
	CAX2630	28 1/2 x 34 1/2	23 7/8 x 29 7/8
	CAX2634	28 1/2 x 38 1/2	23 7/8 x 33 7/8
	CAX2640	28 1/2 x 46 1/2	23 7/8 x 41 7/8
	CAX2646	28 1/2 x 52 1/2	23 7/8 x 47 7/8
	CAX2650	28 1/2 x 58 1/2	23 7/8 x 53 7/8
	CAX2656	28 1/2 x 64 1/2	23 7/8 x 59 7/8
	CAX2660	28 1/2 x 70 1/2	23 7/8 x 65 7/8

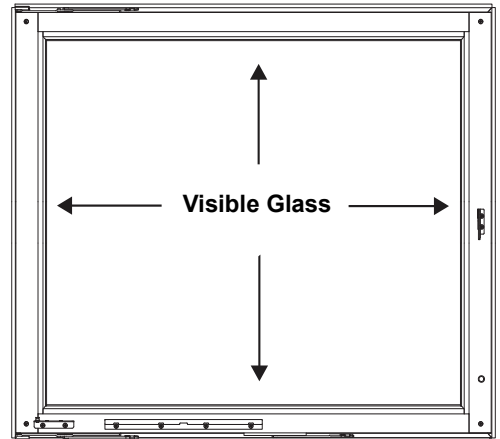

Sash

Sash Size Table				
Unit No.	Sash Dimensions (w x h)	Visible Glass Dimensions (w x h)	Graphic	
28	CAX2820	30 1/2 x 22 1/2	25 7/8 x 17 7/8	
	CAX2826	30 1/2 x 28 1/2	25 7/8 x 23 7/8	
	CAX2828	30 1/2 x 30 1/2	25 7/8 x 25 7/8	
	CAX2830	30 1/2 x 34 1/2	25 7/8 x 29 7/8	
	CAX2834	30 1/2 x 38 1/2	25 7/8 x 33 7/8	
	CAX2840	30 1/2 x 46 1/2	25 7/8 x 41 7/8	
	CAX2846	30 1/2 x 52 1/2	25 7/8 x 47 7/8	
	CAX2850	30 1/2 x 58 1/2	25 7/8 x 53 7/8	
	CAX2856	30 1/2 x 64 1/2	25 7/8 x 59 7/8	
	CAX2860	30 1/2 x 70 1/2	25 7/8 x 65 7/8	
30	CAX3020	34 1/2 x 22 1/2	29 7/8 x 17 7/8	
	CAX3026	34 1/2 x 28 1/2	29 7/8 x 23 7/8	
	CAX3028	34 1/2 x 30 1/2	29 7/8 x 25 7/8	
	CAX3030	34 1/2 x 34 1/2	29 7/8 x 29 7/8	
	CAX3034	34 1/2 x 38 1/2	29 7/8 x 33 7/8	
	CAX3040	34 1/2 x 46 1/2	29 7/8 x 41 7/8	
	CAX3046	34 1/2 x 52 1/2	29 7/8 x 47 7/8	
	CAX3050	34 1/2 x 58 1/2	29 7/8 x 53 7/8	
	CAX3056	34 1/2 x 64 1/2	29 7/8 x 59 7/8	
	CAX3060	34 1/2 x 70 1/2	29 7/8 x 65 7/8	

Sash Graphic

Note:

Standard venting casement sash shown. See additional [casement types](#).

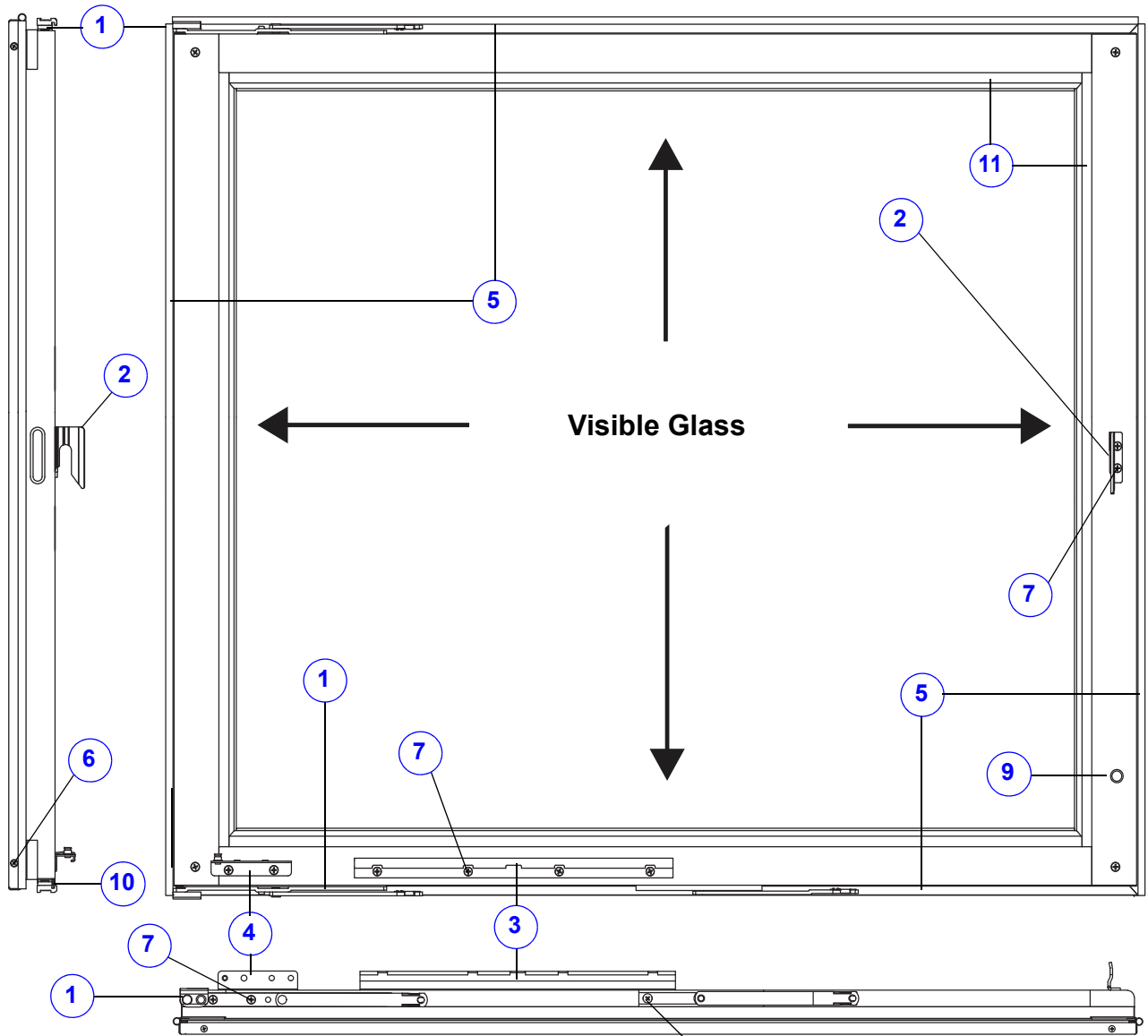

- | | | |
|---|----------------------------------|--------------------------|
| 1. Hinge | 6. Screw | 11. Stop |
| 2. Keeper | 7. Screw | |
| 3. Sash Track (2 types) | 8. Screw | |
| 4. Bracket (3 types) | 9. Sleeve Magnet | |
| 5. Weatherstrip | 10. Hinge Shim | |

E-Series Casement Sash

Sash viewed from interior

Sash

Sash

Sash - Operating

Note:

Replacement sash for windows are made to order and can be configured through iQ. Current glazings replace previous vintage glazings. Product ID label is located on the head jamb.

Low-E4®
Andersen
AW
Low-E4®
ECC® / FHM® CS-XX YMMDD

Low-E4® Sun 3
Andersen
AW
Sun 3 Low-E4®
ECC® / FHM® CS-XX YMMDD

Low-E4® SmartSun™
Andersen
AW
SmartSun Low-E4®
ECC® / FHM® CS-XX YMMDD

Low-E4® PassiveSun®
Andersen
AW
PassiveSun Low-E4®
ECC® / FHM® CS-XX YMMDD

Dual Pane Clear
Andersen
AW
Dual Pane Clear
ECC® / FHM® CS-XX YMMDD

Special Product Request (SPR)
Andersen
AW
Special Product Request (SPR)
ECC® / FHM® CS-XX YMMDD

Low-E4® SmartSun™ HeatLock™
Andersen
AW
SmartSun Low-E4® HeatLock™
ECC® / FHM® CS-XX YMMDD

Low-E4® HeatLock™
Andersen
AW
Low-E4® HeatLock™
ECC® / FHM® CS-XX YMMDD

TEMPERED
ANSI Z97.1-2009
UA S GCC XXXX
16 CFR 1201.11
CIG-XX Xmm MM/DD/YR
CAN/CGSB 12.1-M90

Exterior color options:
Interior species/finish/color options:
Glass options (See Logo/Etching Examples):

Low-E4®	Low-E4® HeatLock	Low-E4® SmartSun HeatLock
Low-E4® SmartSun™	Low-E4® Smart-Sun HeatLock	Low-E4® Triple-Pane
Low-E4® Passive Sun	Low-E4® Sun Heat-Lock	Low-E4® Smart-Sun Triple-Pane
Low-E4® Sun 3	Low-E4® HeatLock Tempered	Low-E4® Enhanced Triple-Pane
Low-E4® Tempered	Dual Pane Clear	Low-E4® Smart-Sun Enhanced Triple-Pane
Low-E4® SmartSun Tempered	Cascade	Low-E4® Enhanced Triple-Pane Heat-Lock
Low-E4® Passive Sun Tempered	Fern	Low-E4® Smart-Sun Enhanced Triple-Pane HeatLock
Low-E4® Sun Tempered	Reed	

To order, state:

Product ID (from product label, see [Service Guide 9051877](#))

OR

1. Unit or frame size (CAX XXXX or frame W x H dimensions)
2. Description of part (Sash)
3. Sash handing (Right, Left, or Stationary)
4. Exterior color of sash to be replaced
5. Interior wood species/finish/color of sash to be replaced
6. Glazing/Grille type
7. Glass Stop Type (Ovolo, Contemporary)
8. Manufacturing Date

E-Series Casement Windows (2011 to Present)

Standard Windows

Sash

Weatherstrip				
Weatherstrip				
		Color	Size	Order No.
		White	10 ft (120")	9103912
		Black		9103913
		White	25 ft (300")	9103816
		Black		9103817

Glass

Glass

Glass

Note:
 Replacement glass is made to order and can be configured through iQ. Current glazings replace previous vintage glazings. Product ID label is located on the head jamb. Glass ships with sealant and spacers. See [Accessory Guide 9176386](#).

TEMPERED UA
 16 CFR 1201 II
 ANSI Z97.1-2009
 SGGC XXXX
 CIG-XX Xmm MM/DD/YR
 CAN/CGSB 12.1-M90

Exterior color options:
Interior species/finish/color options:
Glass options (See Logo/Etching Examples):

Low-E4®	Low-E4® HeatLock	Low-E4® SmartSun HeatLock
Low-E4® SmartSun™	Low-E4® Smart-Sun HeatLock	Low-E4® Triple-Pane
Low-E4® Passive Sun	Low-E4® Sun Heat-Lock	Low-E4® Smart-Sun Triple-Pane
Low-E4® Sun 3	Low-E4® HeatLock Tempered	Low-E4® Enhanced Triple-Pane
Low-E4® Tempered	Dual Pane Clear	Low-E4® Smart-Sun Enhanced Triple-Pane
Low-E4® SmartSun Tempered	Cascade	Low-E4® Enhanced Triple-Pane Heat-Lock
Low-E4® Passive Sun Tempered	Fern	Low-E4® Smart-Sun Enhanced Triple-Pane HeatLock
Low-E4® Sun Tempered	Reed	

To order, state:
Product ID (from product label, see [Service Guide 9051877](#))
OR

1. Unit or frame size (CAX XXXX or frame W x H dimensions)
2. Description of part (Glass)
3. Glazing/Grille type
4. Glass Stop Type (Ovolo, Contemporary)
5. Manufacturing Date

Glass Stops

Stops - Top / Bottom / Side

Note:

Stops (top, bottom and side) are made to order.

To order, state:

Product ID (from product label, see [Service Guide 9051877](#))

OR

1. Description of Part/Size (Stop)
2. Color/Species/Finish
3. Location/Handing (Top, Bottom, Side)
4. Type (Ovolo, Contemporary)
5. Manufacturing Date

Interior species/finish/color options

WOOD SPECIES

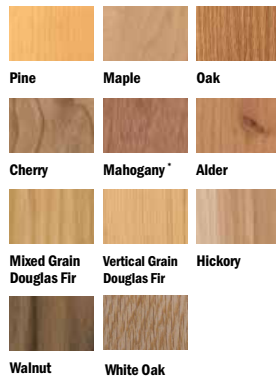

FACTORY-FINISHED INTERIORS



PAINTED OPTIONS



Glass

Glass Parts			
Glazing Tape			
Note: See Accessory Guide 9064542 .			
		Color	Order No.
		Gray	33751RL
Silicone Bed Glazing			
		Color	Order No.
		Dove Gray	9164412
Glass Spacer			
			Order No.
			9152146

Insect Screens

Insect Screen

Note:

Retractable and standard screens available in fiberglass, aluminum and TruScene® material. Replacement insect screens can be configured in iQ.

Color/finish options



Interior species/finish/color options

WOOD SPECIES

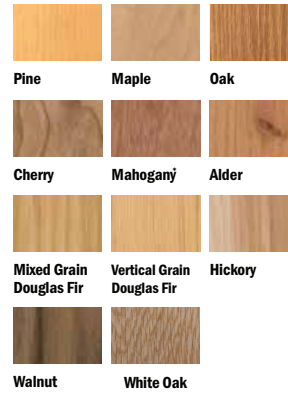

FACTORY-FINISHED INTERIORS



Standard Screen

Retractable Screen

Insect Screens

Insect Screen - Standard Screens

Insect Screen - Standard Screens



Unit No.	Dimensions (w x h)
15 3/4	CAX1520 14 5/32 X 19 21/32
	CAX1526 14 5/32 X 25 21/32
	CAX1528 14 5/32 X 27 21/32
	CAX1530 14 5/32 X 31 21/32
	CAX1534 14 5/32 X 35 21/32
	CAX1540 14 5/32 X 43 21/32
	CAX1546 14 5/32 X 49 21/32
	CAX1550 14 5/32 X 55 21/32
	CAX1556 14 5/32 X 61 21/32
	CAX1560 14 5/32 X 67 21/32
18	CAX1820 16 13/32 X 19 21/32
	CAX1826 16 13/32 X 25 21/32
	CAX1828 16 13/32 X 27 21/32
	CAX1830 16 13/32 X 31 21/32
	CAX1834 16 13/32 X 35 21/32
	CAX1840 16 13/32 X 43 21/32
	CAX1846 16 13/32 X 49 21/32
	CAX1856 16 13/32 X 55 21/32
	CAX1866 16 13/32 X 61 21/32
	CAX1860 16 13/32 X 67 21/32
20	CAX2020 20 13/32 X 19 21/32
	CAX2026 20 13/32 X 25 21/32
	CAX2028 20 13/32 X 27 21/32
	CAX2030 20 13/32 X 31 21/32
	CAX2034 20 13/32 X 35 21/32
	CAX2040 20 13/32 X 43 21/32
	CAX2046 20 13/32 X 49 21/32
	CAX2050 20 13/32 X 55 21/32
	CAX2056 20 13/32 X 61 21/32
	CAX2060 20 13/32 X 67 21/32

E-Series Casement Windows (2011 to Present)

Standard Windows

Insect Screens

Insect Screen - Standard Screens		
		
Unit No.	Dimensions (w x h)	
24	CAX2420	24 ¹³ / ₃₂ X 19 ²¹ / ₃₂
	CAX2426	24 ¹³ / ₃₂ X 25 ²¹ / ₃₂
	CAX2428	24 ¹³ / ₃₂ X 27 ²¹ / ₃₂
	CAX2430	24 ¹³ / ₃₂ X 32 ¹³ / ₃₂
	CAX2434	24 ¹³ / ₃₂ X 35 ²¹ / ₃₂
	CAX2440	24 ¹³ / ₃₂ X 43 ²¹ / ₃₂
	CAX2446	24 ¹³ / ₃₂ X 49 ²¹ / ₃₂
	CAX2450	24 ¹³ / ₃₂ X 55 ²¹ / ₃₂
	CAX2456	24 ¹³ / ₃₂ X 61 ²¹ / ₃₂
	CAX2460	24 ¹³ / ₃₂ X 67 ²¹ / ₃₂
26	CAX2620	26 ¹³ / ₃₂ X 19 ²¹ / ₃₂
	CAX2626	26 ¹³ / ₃₂ X 25 ²¹ / ₃₂
	CAX2628	26 ¹³ / ₃₂ X 27 ²¹ / ₃₂
	CAX2630	26 ¹³ / ₃₂ X 31 ²¹ / ₃₂
	CAX2634	26 ¹³ / ₃₂ X 35 ²¹ / ₃₂
	CAX2640	26 ¹³ / ₃₂ X 43 ²¹ / ₃₂
	CAX2646	26 ¹³ / ₃₂ X 49 ²¹ / ₃₂
	CAX250	26 ¹³ / ₃₂ X 55 ²¹ / ₃₂
	CAX2656	26 ¹³ / ₃₂ X 61 ²¹ / ₃₂
	CAX2660	26 ¹³ / ₃₂ X 67 ²¹ / ₃₂
28	CAX2820	28 ¹³ / ₃₂ X 19 ²¹ / ₃₂
	CAX2826	28 ¹³ / ₃₂ X 25 ²¹ / ₃₂
	CAX2828	28 ¹³ / ₃₂ X 27 ²¹ / ₃₂
	CAX2830	28 ¹³ / ₃₂ X 31 ²¹ / ₃₂
	CAX2834	28 ¹³ / ₃₂ X 35 ²¹ / ₃₂
	CAX2840	28 ¹³ / ₃₂ X 43 ²¹ / ₃₂
	CAX2846	28 ¹³ / ₃₂ X 49 ²¹ / ₃₂
	CAX2850	28 ¹³ / ₃₂ X 55 ²¹ / ₃₂
	CAX2856	28 ¹³ / ₃₂ X 61 ²¹ / ₃₂
	CAX2860	28 ¹³ / ₃₂ X 67 ²¹ / ₃₂

Insect Screens

Insect Screen - Standard Screens		
		
Unit No.	Dimensions (w x h)	
30	CAX3020	32 ¹³ / ₃₂ X 19 ²¹ / ₃₂
	CAX3026	32 ¹³ / ₃₂ X 25 ²¹ / ₃₂
	CAX3028	32 ¹³ / ₃₂ X 27 ²¹ / ₃₂
	CAX3030	32 ¹³ / ₃₂ X 31 ²¹ / ₃₂
	CAX3034	32 ¹³ / ₃₂ X 35 ²¹ / ₃₂
	CAX3040	32 ¹³ / ₃₂ X 43 ²¹ / ₃₂
	CAX3046	32 ¹³ / ₃₂ X 49 ²¹ / ₃₂
	CAX3050	32 ¹³ / ₃₂ X 55 ²¹ / ₃₂
	CAX3056	32 ¹³ / ₃₂ X 61 ²¹ / ₃₂
	CAX3060	32 ¹³ / ₃₂ X 67 ²¹ / ₃₂

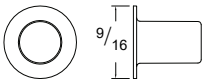
Insect Screen Parts		
Grommet		
<p>Note: Used with standard and wood veneer screen.</p>		
		Order No.
		0009220

Grilles

Grilles

Note:

Replacement sash with permanently applied grilles and finelight grilles can be configured in iQ. Replacement removable interior grilles can be configured in iQ. Removable grilles are only available in 7/8" profile.

Exterior color/finish options



ANNODIZED FINISHES

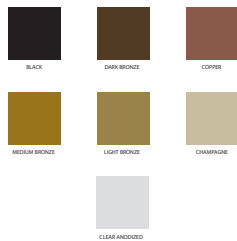

Interior species/finish/color options

WOOD SPECIES

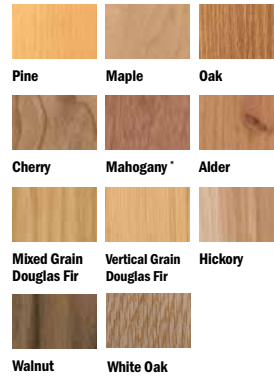

FACTORY-FINISHED INTERIORS

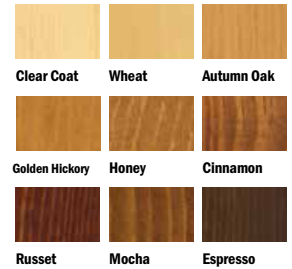

PAINTED OPTIONS



Grilles

Grille Options

Note:

Replacement sash with permanently applied grilles and finelight grilles can be configured in iQ. Replacement removable interior grilles can be configured in iQ. Removable grilles are only available in 7/8" profile.

Types



Full Divided Light

Give any window an authentic look with full divided light grilles that are permanently applied to the interior and exterior of your window with a spacer between the glass.



Simulated Divided Light

An economical solution with traditional beauty, our Simulated Divided Light features fixed exterior and interior grilles without an internal spacer.



Removable Interior Wood Grilles

Our removable wood grilles are installed on the interior surface. They are available with an optional surround and an optional permanently applied exterior grille.



Finelight™ Grilles-Between-the-Glass

Aluminum grilles conveniently placed between two panes of glass make the glass easy to clean inside and out.

Profiles

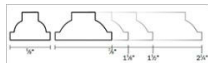

Interior Wood: Ovolo (Colonial)

Widths:

- 5/8"
- 7/8"
- 1 1/8"
- 1 1/2"
- 2 1/4"

Available with:

- Full Divided Light
- Simulated Divided Light

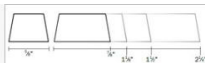

Interior Wood: Contemporary

Widths:

- 5/8"
- 7/8"
- 1 1/8"
- 1 1/2"
- 2 1/4"

Available with:

- Full Divided Light
- Simulated Divided Light

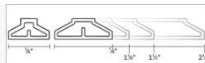

Exterior Aluminum: Chamfer

Widths:

- 5/8"
- 7/8"
- 1 1/8"
- 1 1/2"
- 2 1/4"

Available with:

- Full Divided Light
- Simulated Divided Light
- Removable Interior Wood with Optional Permanently Applied Exterior Grille

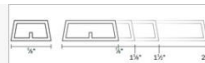

Exterior Aluminum: Contemporary

Widths:

- 5/8"
- 7/8"
- 1 1/8"
- 1 1/2"
- 2 1/4"

Available with:

- Full Divided Light
- Simulated Divided Light
- Removable Interior Wood with Optional Permanently Applied Exterior Grille

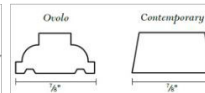

Removable Interior Wood Grilles

Ovolo or Contemporary profiles in 7/8" width

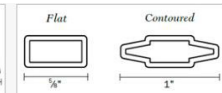

Finelight Grille Profiles and Widths

Flat or Contoured profiles in 5/8" or 1" widths

Patterns

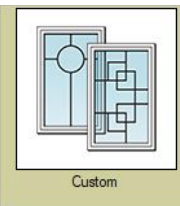
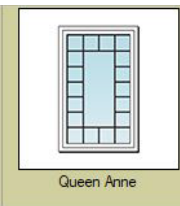
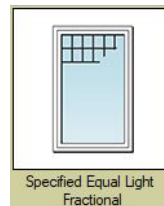
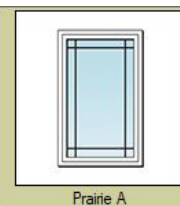
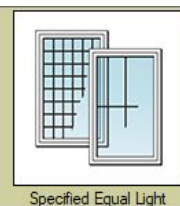
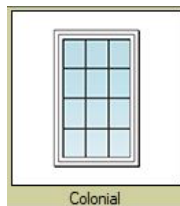

E-Series Casement Windows (2011 to Present)

Standard Windows

Grilles

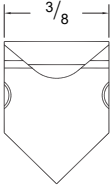
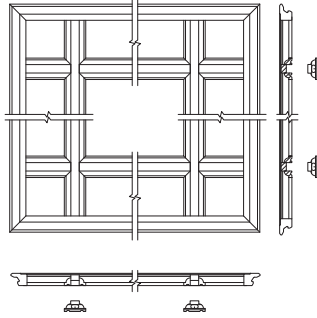
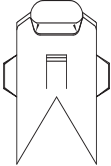
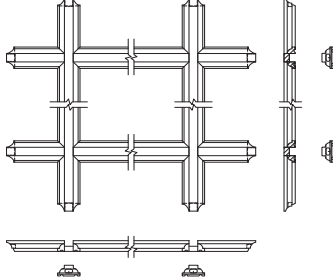
Interior Grille Parts				
Clip - Surround				
Note: Used with framed removable grilles.				
		<table border="1" style="width: 100%; border-collapse: collapse;"> <tr> <th style="text-align: left; padding: 5px;">Order No.</th> </tr> <tr> <td style="padding: 5px;">0004900</td> </tr> </table>	Order No.	0004900
Order No.				
0004900				
Clip - Knocked Down				
Note: Used with knocked down removable grilles.				
		<table border="1" style="width: 100%; border-collapse: collapse;"> <tr> <th style="text-align: left; padding: 5px;">Order No.</th> </tr> <tr> <td style="padding: 5px;">0004901</td> </tr> </table>	Order No.	0004901
Order No.				
0004901				

Hardware

Operator > 21"

Note:

Used on unit frame widths wider than 21". This operator secures to a sash track.

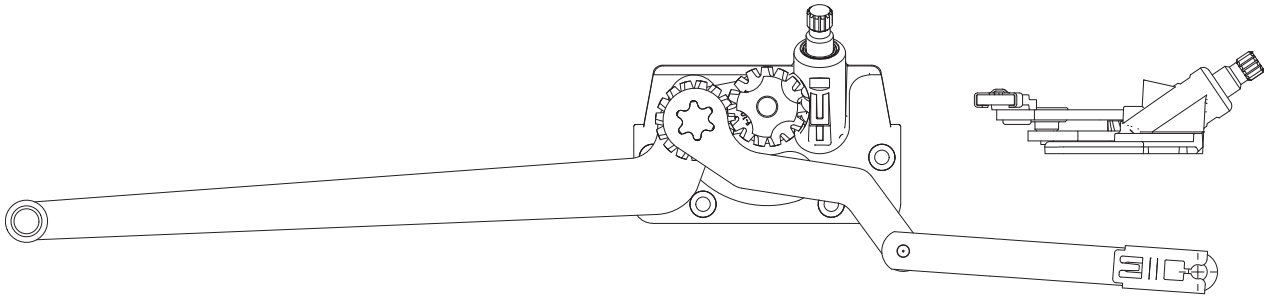

Casement Operator

Operator Picture

Operator / > 21"

LH	RH
0007642	0007643

Bracket / Operator

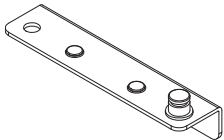

LH	RH
0007644	0007645

Track / Operator

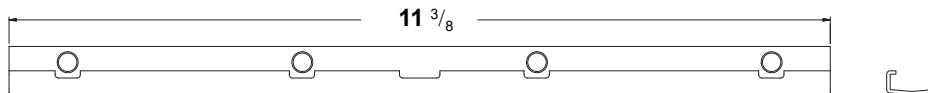

Order No.
0007672

Shim / Operator

Order No.
0067498

Screw

Size:
#8 x 1" PFHSMS

Finish	Order No.
Z & Y	0013396

E-Series Casement Windows (2011 to Present)

Standard Windows

Hardware

Operator < 21" (Split Arm)

Note:

Used on unit frame widths less than 21".

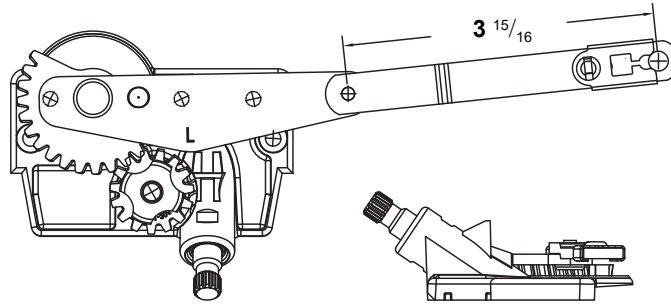

Casement Operator

Operator Picture

Operator / < 21"

LH	RH
0007650	0007651

Bracket / Operator

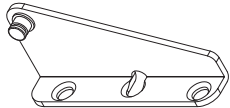

LH	RH
0007652	0007653

Screw

Size: #8 x 1" PFHSMS	Finish	Order No.
	Z & Y	0013396

Hardware

Operator > 20" Egress

Note:

Used on egress units and frame width greater than 20".

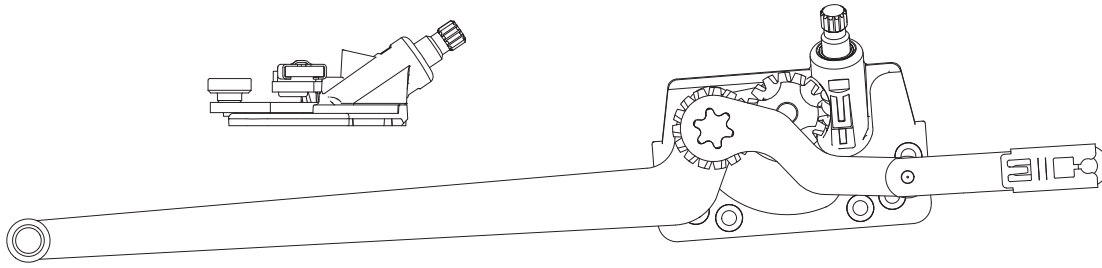

Casement Operator

Operator Picture

Operator / > 20" Egress

LH

RH

0007646

0007647

Bracket / Operator

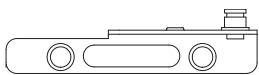

LH

RH

0007648

0007649

Screw

Size:

#8 x 1" PFHSMS

Finish

Z & Y

Order No.

0013396

Track / Operator

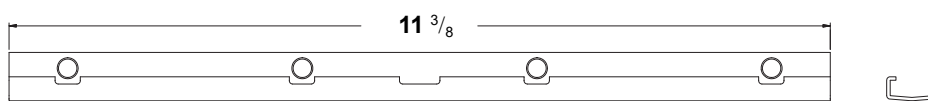

Order No.

0007672

E-Series Casement Windows (2011 to Present)

Standard Windows

Hardware

Operator / Piano Hinge

Note:
Stainless Steel.

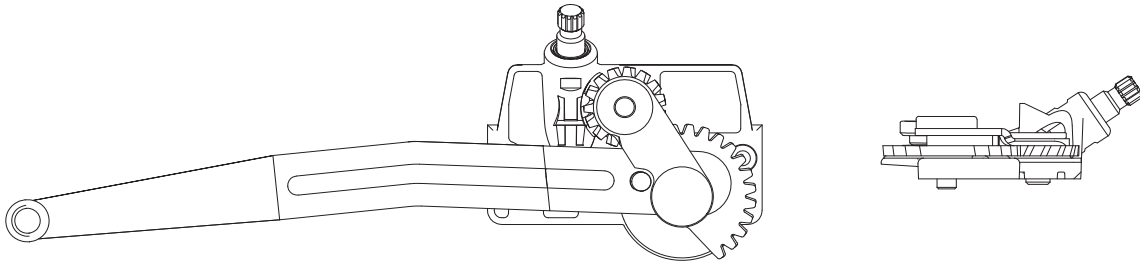

French Casement Operator

Operator / > 21"

LH	RH
0011828	0011829

Track / Operator

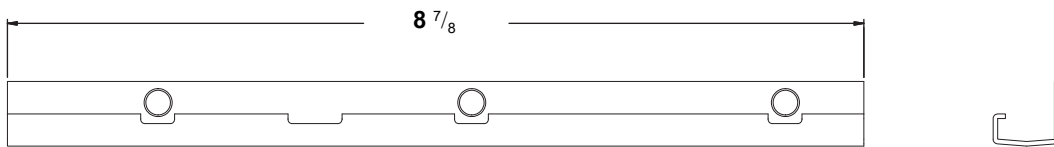

Order No.
0007673

Screw / Operator Track

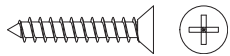

Description	Finish	Order No.
#7 x 7/8" PFHSMS Type AB Stainless Steel	Stainless Steel	0015746

Shim / Operator

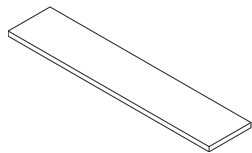

Order No.
0067498

Screw / Shim

Description	Finish	Order No.
#8 x 1" PFHSMS	Z & Y	0013396

Hardware

Hinge - Piano

Hinge - Piano

Note:

Secures to sash and frame. Used on 2860, 3056 and 3060 sizes.

To order, state:

Product ID (from product label, see [Service Guide 9051877](#))

OR

1. Unit height
2. Description of part (Piano Hinge 2")
3. Hinge color (Black, Stainless Steel)

Screw - Piano Hinge

	Description	Order No.
	#6 X 1 1/4 PFHSMS Type AB 18-8 SS	0021983

Screw - Piano Hinge (Frame)

	Description	Order No.
	#7 X 5/8 SS	0015331

E-Series Casement Windows (2011 to Present)

Standard Windows

Hardware

Hinge Components

Hinge Arm - Stainless Steel 10"

Note: Order 1-LH & 1-RH hinge arm per sash Apply to top or bottom rail of sash depending on the handing. See, [Service Guide 9069219](#)

		Standard		Egress	
		Left	Right	Left	Right
		0007694	0007695	0007688	0007689

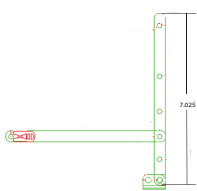

Screw - Hinge Arm

Note:
Also used to secure keeper.

	Description	Order No.
	#7 X 1 1/4 PH FH SHT MTL Type AB 18-8 SS	0027959

Hinge Track - Stainless Steel 10"

Note:
Order 1-LH & 1-RH hinge track per sash. Apply to top or bottom depending on the handing. See, [Service Guide 9069220](#)

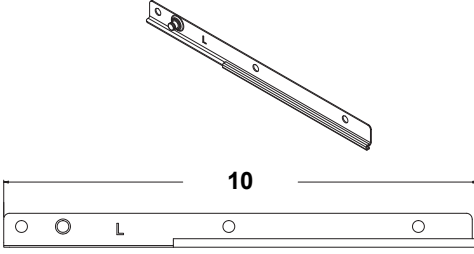
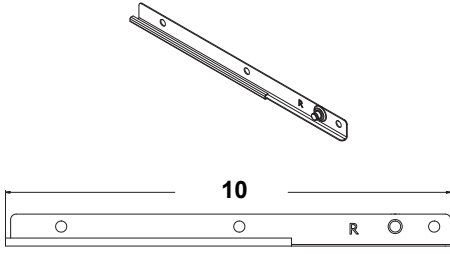
 <p>10</p> <p>Left</p>	 <p>10</p> <p>Right</p>		
		Order No.	
		Left	Right
		0007696	0007697

Screw - Hinge Track

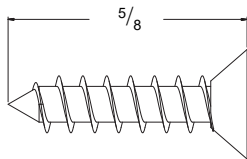
	Size: #7 x 5/8" PFHSMS	Finish Stainless Steel	Order No. 0015331
---	----------------------------------	----------------------------------	-----------------------------

Hardware

Shim - Hinge	
	Order No.
	0011415

Hardware Packs			
Complete Hardware Kit			
Kit Includes:			
(1) Lock Bezel	(1) Lock Handle		
(1) Folding Handle	(1) Operator Cover		
		Order No.	
		Color	
			LH RH
		Black	9078345 9078346
		Gold	9078347 9078348
		Bronze	9078349 9078350
		White	9078351 9078352
		Antique Brass	9078359 9078360
		Bright Brass	9078361 9078362
		Satin Chrome	9078357 9078358
		Bright Chrome	9078355 9078356
		Oil Rubbed Bronze	9078353 9078354
		Pewter	9078363 9078364

Operator Covers			
Operator Cover			
Note: Handed as the unit is handed unless piano hinges are used.			
		Order No.	
		Color	
			LH RH
			RH (Piano) LH (Piano)
		Black	9105294 9105295
		Gold	9105292 9105293
		Bronze	9105290 9105291
		White	9105288 9105289
		Antique Brass	9105306 9105307
		Bright Brass	9105296 9105297
		Satin (Brushed) Chrome	9105302 9105303
		Bright (Polished) Chrome	9105304 9105305
	Bronze	9105290 9105291	
	Oil Rubbed Bronze	9105298 9105299	
	Pewter	9105300 9105301	

E-Series Casement Windows (2011 to Present)

Standard Windows

Hardware

Handles

Folding Handle (Crank)

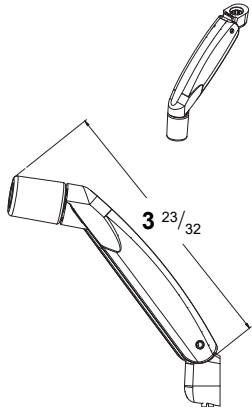

Note:

Finish

Order No.

Black

0007663

Gold

0007662

Bronze

0007661

White

0007660

Antique Brass

0007669

Bright Brass

0007664

Satin Chrome

0007667

Bright Chrome

0007668

Oil Rubbed
Bronze

0007665

Pewter

0007666

Temporary Handle - Operator

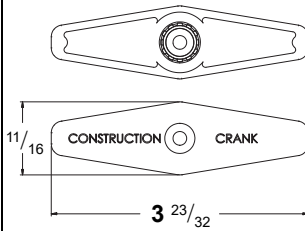

Order No.

0007896

Hardware

Locks and Lock Components

Lock Bar					
	Type	Size	Used with Unit Height	Left	Right
	Single Point	6 ⁷ / ₁₆	>16 ≤ 24	0008812	
		9 ⁵ / ₁₆		0018386	0018387
		11 ¹ / ₄	>24 ≤ 32	0008830	
		17 ¹ / ₄	>32 ≤ 36	0008832	
	Double Point	23 ¹ / ₄	>36 ≤ 42	0008836	
		29 ¹ / ₄	>42 ≤ 48	0008838	
		35 ¹ / ₄	>48 ≤ 54	0008840	
		41 ¹ / ₄	>54 ≤ 60	0008842	
		47 ¹ / ₄	>60 ≤ 66	0008844	
	Triple Point	53 ¹ / ₄	>66 ≤ 72	0008846	
		59 ¹ / ₄	>72 ≤ 78	0008848	
		65 ¹ / ₄	>78 ≤ 84	0008850	
		71 ¹ / ₄	>84 ≤ 90	0008852	
		77 ¹ / ₄	>90 ≤ 96	0008854	

Lock Bezel		Finish	Order No.
	Note:	Black	0008822
		Gold	0008823
		Bronze	0008821
		White	0008820
		Antique Brass	9105277
		Bright Brass	0008824
		Satin Chrome	9105275
		Bright Chrome	9105276
		Oil Rubbed Bronze	9105274
		Pewter	9105273

Lock Handle		Finish	Standard
		Black	0013519
		Gold	0013520
		Bronze	0013518
		White	0013517
		Antique Brass	0013526
		Bright Brass	0013521
		Satin Chrome	0013524
		Bright Chrome	0013525
		Oil Rubbed Bronze	0013523
		Pewter	0013522

E-Series Casement Windows (2011 to Present)

Standard Windows

Hardware

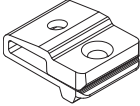
Lock Bar Guide			
		Finish	Order No.
		Black	0008806

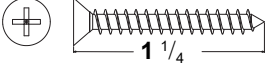
Screw / Lock Bar Guide			
		Finish	Order No.
		Black	0033460

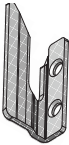
Keeper			
		LH	RH
		0008807	0008808

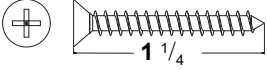
Screw / Keeper				
Note: #6 Used with hardwoods, #7 Used with pine				
	Description:		Finish	Order No.
	#6 X 1 1/4 PFHSMS TEKS		Stainless Steel	9105801
	#7 X 1 1/4 PFHSMS TYPE AB		Stainless Steel	0027959

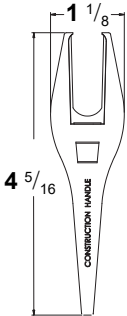
Temporary Handle - Lock		Order No.
		0008949

Hardware

Optional Hardware

Opening Control Device Kit

Kit Includes:

- (1) Frame Bracket
- (1) Sash Bracket
- (1) Push Button Assembly
- (1) Screw Packet
- (1) Safety Card (Not shown)
- (1) Template
- (1) [Accessory Guide 9069031](#)

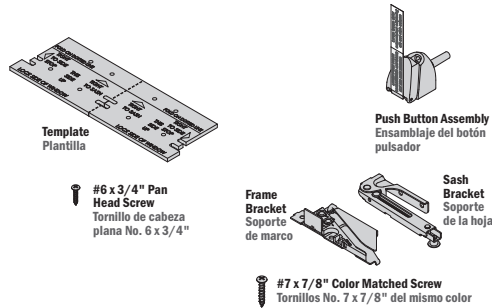

Finish	Left	Right
White	0049251	0049253
Stone	0049255	0049257

Installation Kit / Opening Control Device

Kit Includes:

- (1) Drill Guide
- (1) Drill Bit
- (1) Self Tapping Screw



Order No.
0049259

Sleeve Magnet

Note:
Used with Verilock.

Finish	Order No.
White	0015968
Stone	0015967

Sash Limiter Kit

Kit Includes:

- (1) Limiter Track
- (1) Limiter Bracket
- (1) Limiter Pivot Arm
- (4) Fasteners

Order No.
9142251

Fasteners

Screw - Sash Limiter

Description	Order No.
#8 X 3/4 PPHSMS Type AB 18-8 SS	0033736

Frames

Frame Graphic - Standard Windows

Note:

Replacement frames can be configured in iQ. Standard casement unit shown. See additional [casement types](#).

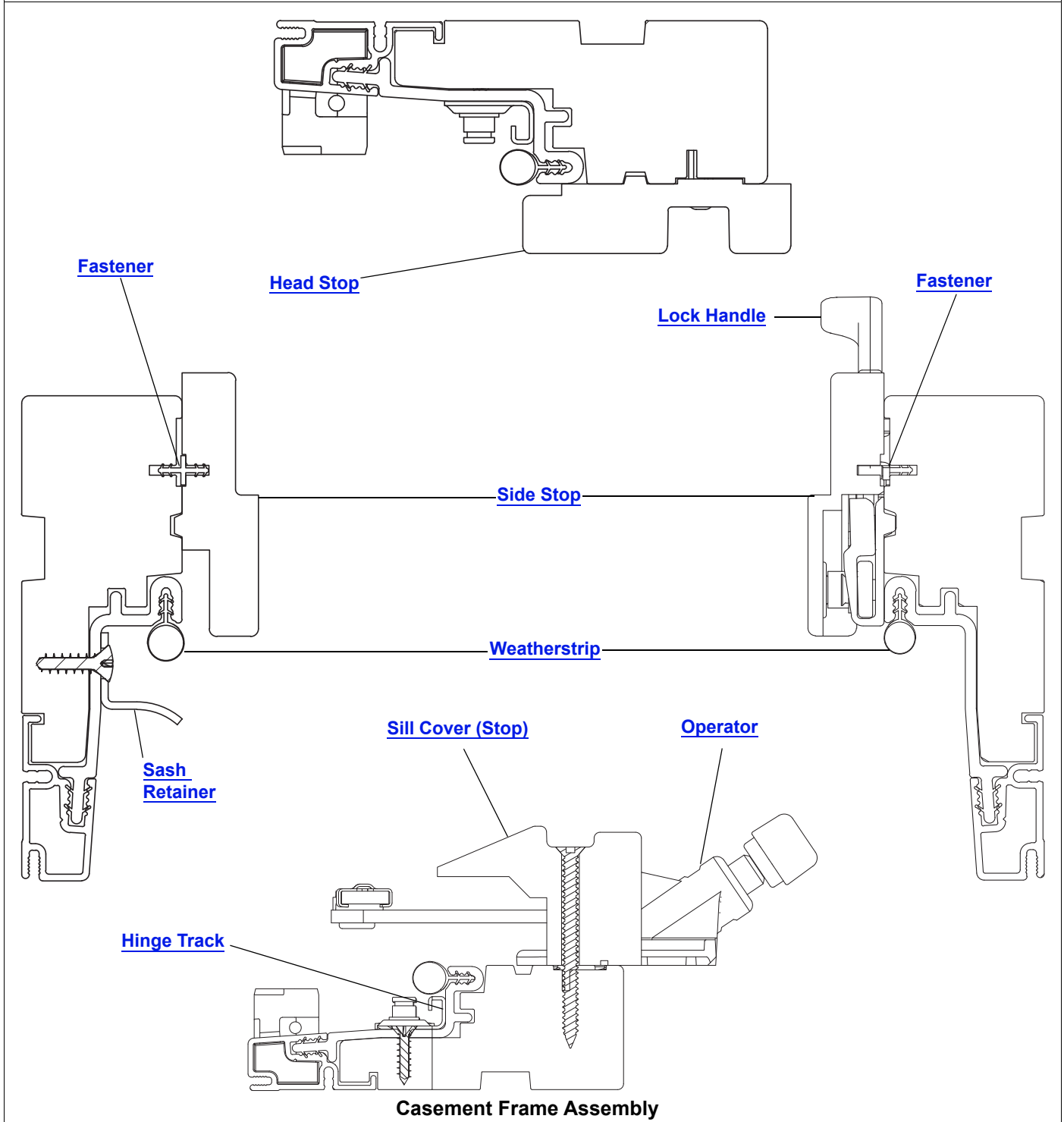

Frames

Frame

Note:

Replacement frames ship with hardware.

To order, state:

Product ID (from product label, see [Service Guide 9051877](#))

OR

1. Description of Part/Size (CAX XXXX or frame W X H dimensions)
2. Colors/Species/Finish
3. Manufacturing Date

Exterior color/finish options



ANNODIZED FINISHES



Interior species/finish/color options

WOOD SPECIES

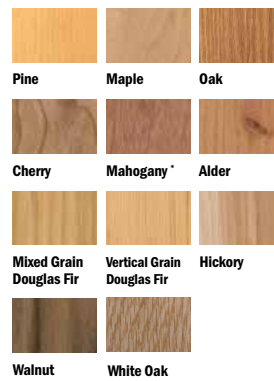

FACTORY-FINISHED INTERIORS



PAINTED OPTIONS



Stops

Stops - Head / Sill / Side

Note:

Stops (head, sill and side) are made to order.

To order, state:

Product ID (from product label, see [Service Guide 9051877](#))

OR

1. Description of Part/Size (Stop)
2. Color/Species/Finish
3. Location/Handing (Head, Sill, Lock Jamb, Hinge Jamb, LH, RH)
4. Manufacturing Date

Interior species/finish/color options

WOOD SPECIES

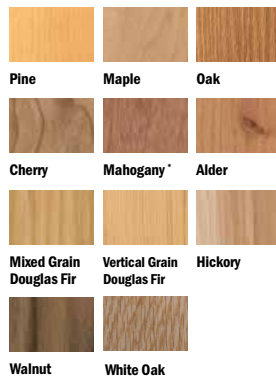

FACTORY-FINISHED INTERIORS



PAINTED OPTIONS



Frames

Weatherstrip			
Weatherstrip			
		Size	Order No.
		10 ft (120")	9103914
		25 ft (300")	9103915

Frame Parts			
Fastener			
		Size	Order No.
		3"	000CFS3
		6"	000CFS6
		34"	00CFS34
		55"	00CFS55
96"	00CFS96		

Sash Retainer			
		Finish	Order No.
		Unfinished	9105321

Screw - Sash Retainer			
		Finish	Order No.
		Unfinished	0040120

Screw - Plowless Stop			
		Order No.	
		9173234	

Shim / Verilock			
Note: Verilock discontinued in July 2021 .			
		Order No.	
		0011080	

E-Series Casement Windows (2011 to Present)

Standard Windows

Frames

Installation Material

Note:

The Rigid Nailfin and Rigid Nailfin with Clear Drip Cap is the standard Nailfin option. The rigid nailfin is used for the bottom and sides, and the Rigid Nailfin with Integral Clear Drip Cap is used for the top of the unit. See [chevron/corner pad pack](#).

Rigid Nailfin with Integral Clear Drip Cap / Head

		Length	Order No.
		17 3/4"	9124508
		20"	9124509
		24"	9124510
		28"	9124511
		30"	9124512
		32"	9124513
		36"	9124514
		40"	9124515
		44"	9124516
		48"	9124517
		60"	9124518
		72"	9124519
		96"	9124505
	144"	9124506	
	192"	9124507	

Rigid Nailfin / Sides & Bottom

	Length	Order No.	Length	Order No.
	17 3/4"	9124479	80"	9124495
	20"	9124480	84"	9124496
	24"	9124481	88"	9124497
	28"	9124482	90"	9124498
	30"	9124483	95 3/4"	9124499
	32"	9124484	96"	9124500
	36"	9124485	108"	9124501
	40"	9124486	120"	9124502
	44"	9124487	144"	9124503
	48"	9124488	192"	9124504
	54"	9124489		
	60"	9124490		
	64"	9124491		
	66"	9124492		
	72"	9124493		
78"	9124494			

Frames

Corner Pad Seal		
<p>Note: Ships as a quantity of four. Adhesive back.</p>		
		<p>Order No.</p>
		<p>0015327</p>

Rigid Nail Fin with Receiver for Aluminum Drip Receiver		
<p>Note: The Rigid Nailfin with Drip Receiver is only used for the top of the unit, combined with the standard Rigid Nailfin will be used for the bottom and sides. This Nailfin is made to receive the Color matched Extended Metal Drip Cap and will come applied to the unit. Color matched Extended Aluminum Drip Cap will have to be manually added as a new line item and applied in the field.</p>		
		<p>Length</p>
		<p>144"</p>

E-Series Casement Windows (2011 to Present)

Standard Windows

Frames

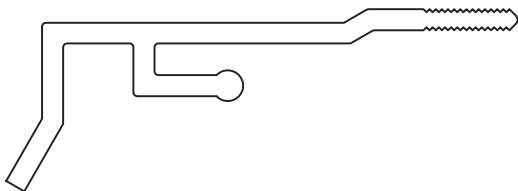
Extended Drip Cap									
Note: (*) Anodized finishes. See color options .									
									
Color	102"		144"		Color	102"		144"	
	2604	2605	2604	2605		2604	2605	2604	2605
Colony White		9099884	0007972	00K1955	Spearmint	9099859	9099917	0083841	00K6628
White	9099882	9099943	0069493	0K13957	Aquamarine	9099858	9099916	0086462	00K6627
Eagle Abalone	9099850	9099908	0086516	00K6620	Patina	9099862	9099923	0099828	00K6631
Balsa White	9099831	9099889	0086681	00K6603	Sky Blue	9099838	9099896	0072165	00K6608
Canvas	9099874	9099935	0011021	0K17969	Country Blue	9099834	9099892	9105779	00K6605
Maple Syrup	9099852	9099910	0090389	00K6621	Blue Denim	9099853	9099911	0094936	00K6622
Harvest Gold	9099848	9099906	0097363	00K6618	Watercolor Blue	9099843	9099901	0081370	00K6613
Prairie Grass	9099878	9099939	0011024	0K17972	Caribbean Blue	9099856	9099914	0073354	00K6625
Flagstone	9099833	9099891	0008636	00K1932	Slate	9099854	9099912	9105781	00K6623
Sandtone	9099880	9099941	0069491	0K13955	Moody Blue	9099839	9099897	0084341	00K6609
Pebble Tan	9099828	9099886	0007973	00K6600	Stormy Blue	9099832	9099890	0088395	00K6604
Carmel	9099842	9099900	0086115	00K6612	Dove Gray	9099875	9099936	0011022	0K17970
Terratone	9099881	9099942	0069492	0K13956	Harbor Mist	9099847	9099905	9105780	00K6617
Hot Chocolate	9099855	9099913	0007975	00K6624	Yorktown Pewter	9099846	9099904	0008235	00K6616
Bourbon	9099866	9099927	0088386	00K6633	Smokey Gray	9099864	9099925	0094937	00K1948
Acorn	9099865	9099926	0085721	00K1779	Mystic Gray	9099871	9099932	0099862	00K6638
Coffee Bean	9099868	9099929	0085615	00K6635	Dark Ash	9099870	9099931	0084302	00K6637
Cocoa Bean	9099877	9099938	0011023	0K17971	Black	9099873	9099934	0011020	0K17968
					Clear Anodized*		9099946		
Dark Bronze	9099883	9099944	0049400	0K20894	Champagne*		9099947		
Clay Canyon	9099844	9099902	0097526	00K6614	Light Bronze*		9099950		
Cardinal Red		9099921		00K1899	Medium Bronze*		9099951		
Bing Cherry		9099920		00K6744	Copper*		9099948		
Fire Engine Red		9099922		00K1285	Dark Bronze*		9099949		
Cinnamon Toast	9099837	9099895	0006710	00K6607	Black*		9099945		
Red Rock	9099879	9099940	0011025	0K17973					
Olive	9099835	9099893	0088807	00K6606					
Sage	9099869	9099930	0081088	00K6636					
Billiard Green	9099845	9099903	0008657	00K6615					
Moss	9099863	9099924	0090988	00K6632					
Forest Green	9099876	9099937	0069490	0K13954					
Mallard Green	9099836	9099894	0097849	00K3366					

Frames

Extended Drip Cap

Note:
 (*) Anodized finishes. See [color options](#).

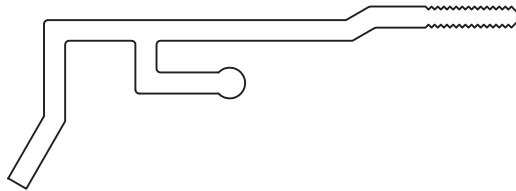

Color	102"		144"		Color	102"		144"	
	2604	2605	2604	2605		2604	2605	2604	2605
Eagle Black	9099851	9099909	0097967	00K1946					
Eagle Cappuccino	9099867	9099928	0086795	00K6634					
Bronze	9099827	9099885	0007971	00K1965					
Eagle Linen	9099872	9099933	0085729	00K6639					
Eagle Blue Mist	9099860	9099918	0067095	00K6629					
Eagle Pink Chablis	9099861	9099919	0067096	00K6630					
Eagle Butterscotch	9099840	9099898	0083552	00K6610					
Eagle Elephant	9099857	9099915	0089080	00K6626					
Eagle Chocolate Chip	9099841	9099899	0086766	00K6611					
Eagle Forest Green	9099829	9099887	0007974	00K6601					
Antique White	9099830	9099888	0008635	00K6602					
Eagle Gray Flannel	9099849	9099907	0094935	00K6619					

E-Series Casement Windows (2011 to Present)

Standard Windows

Frames

Radius Rigid Vinyl Fin

Note:

The Radius Nailfin is used for any unit with a Radius. The Radius Nailfin will be used for the top of the unit and the standard Rigid Nailfin will be used for the bottom and sides. If the top of the unit is a Radius, A drip cap will not be required but the Optional Radius Metal Drip is available below.

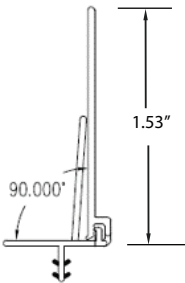
		Length	Order No.
		102"	0654052
		188"	0002974

Radius Metal Drip Cap

Note:

The Optional Radius Metal Drip Cap is only used for any unit with a Radius Top, combined with the Standard Radius Rigid Vinyl Nailfin. Radius Top units do not require a drip cap but some customers prefer the units to match the drip cap look like the rest of their project and can choose to add this optional Radius Metal Color matched Drip Cap.

Provide Color, Base Dimension and Radius Dimension.

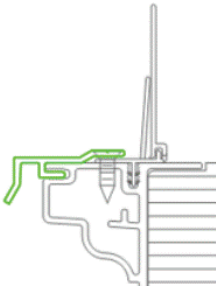
		Length	Order No.
			OBD

Frames

Aluminum Nailfin Flange			
<p>Note: Cross section below shows the aluminum flange attached to a unit. Secured with screws that require an increase in the Rough Opening overall height of 1/4" and 1/8" on each side. For color matched, roll formed drip cap, see Accessory Options path under Installation Materials.</p>			
	Description	Length	Order No.
	Flange Kit w/ Flange Screw Pack	144"	0014072
	Flange	144"	M001931
	Flange Screw Pack		0011141

Metal Drip Cap Colored Screws							
<p>Note: (*) Anodized finishes. See color options.</p>							
Color	2604	2605			Color	2604	2605
Colony White	0013440	0K12250			Spearmint	0093969	0K12283
White	0047477	0K14405			Aquamarine	0093968	0K12282
Eagle Abalone	0073381	0K12274			Patina	0093972	0K12289
Balsa White	0073372	0K12255			Sky Blue	0093961	0K12262
Canvas	0010019				Country Blue	0013450	0K12258
Maple Syrup	0073382	0K12276			Blue Denim	0073383	0K12277
Harvest Gold	0093966	0K12272			Watercolor Blue	0093963	0K12267
Prairie Grass	0010022				Caribbean Blue	0093967	0K12280
Flagstone	0013449	0K12257			Slate	0013453	0K12278
Sandtone	0047475	0K14403			Moody Blue	0093962	0K12263
Pebble Tan	0013446	0K12252			Stormy Blue	0073373	0K12256
Carmel	0073378	0K12266			Dove Gray	0010020	0K17660
Terratone	0047476	0K14404			Harbor Mist	0013452	0K12271
Hot Chocolate	0073384	0K12279			Yorktown Pewter	0093965	0K12270
Bourbon	0093973	0K12293			Smokey Gray	0073387	0K12291

E-Series Casement Windows (2011 to Present)

Standard Windows

Frames

Metal Drip Cap Colored Screws

Note:

(*) Anodized finishes. See [color options](#).

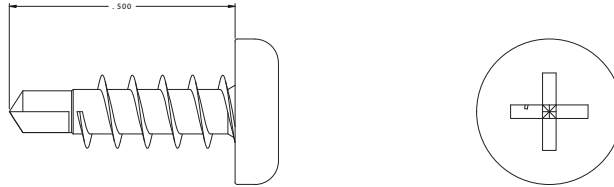

Color	2604	2605			Color	2604	2605		
Acorn	0073388	0K12292			Mystic Gray	0073393	0K12298		
Coffee Bean	0010021	0K17659			Dark Ash	0073392	0K12297		
Cocoa Bean	0073390	0K12295			Black	0010018	0K17656		
					Clear Anodized*				
Dark Bronze	0049367	0K20863			Champagne*	0074524			
Clay Canyon	0073379	0K12268			Light Bronze*	0074525			
Cardinal Red		0K12287			Medium Bronze*	0074526			
Bing Cherry		0K12286			Copper*	0074536			
Fire Engine Red		0K12288			Dark Bronze*				
Cinnamon Toast	0013451	0K12261			Black*				
Red Rock	0010023	0K17661							
Olive	0073374	0K12259							
Sage	0073391	0K12296							
Billiard Green	0093964	0K12269							
Moss	0073386	0K12290							
Forest Green	0047474	0K14402							
Mallard Green	0073375	0K12260							
Eagle Black	0073371	0K12275							
Eagle Cappuccino	0073389	0K12294							
Bronze	0013445	0K12251							
Eagle Linen	0073394	0K12299							
Eagle Blue Mist	0093970	0K12284							
Eagle Pink Chablis	0093971	0K12285							
Eagle Butterscotch	0073376	0K12264							
Eagle Elephant	0073385	0K12281							
Eagle Chocolate Chip	0073377	0K12265							
Eagle Forest Green	0013447	0K12253							
Antique White	0013448	0K12254							
Eagle Gray Flannel	0073380	0K12273							

Frames
