

What's in This Section

Standard and Custom Windows	Page 3
Parts Illustration	3
Parts Illustration - Exterior View	3
Parts Illustration - Interior View	4
Color Options Exterior	5
Color Options Interior	5
Unit Sizes	6
Standard and Custom Window Sizes	6
100 Series Product Label	6
Unit Size Chart - Standard Windows	7
Unit Size Chart - Standard Windows	8
Product History	9
Product History	9
Sash	10
Sash Illustration - Operating	10
Sash Options - Operating	11
Balancer Assembly	12
Balancer Size Chart / Even	13
Balancer Size Chart / Reverse Cottage 3 over 2	14
Balancer Chart	15
Balancer Parts	17
Sash Hardware / Lifts	18
Sash Hardware / Lock Kits/Components	18
Shim Kits/Components	20
Sash Components - Miscellaneous	20
Glazing Beads	20
Glass	21
Glass	21
Insect Screen	22
Insect Screen	22
Insect Screen Parts	22
Hardware	23
Hardware Parts	23
Fasteners	23
Drywall Kit	24
Frames	25
Frame Assembly	25

Frames	26
Exterior Trim Components	26
Frame Hardware / Opening Control Device	27
Frame Components / Miscellaneous	28
Joining Components	31
Joining Components - All Mull Systems	31
Non-Reinforced Joining Components (<i>August 2019 - Present</i>)	33
Reinforced Joining Components (<i>August 2019 - Present</i>)	35
Reinforced Easy Connect Joining Components (<i>August 2019 - Present</i>)	37
Vintage Joining Components (<i>2012 - July 2019</i>)	38
Drip Caps	39
Service Replacement	Page 41
Service Replacement Only Parts	41
Service Replacement Only Parts	41
Weatherstrip	41
Sash Components - Miscellaneous	41
Trim Strip	42
Plug	42
Spacer	42
Glazing Bead	42
Grille / Vinyl	43
817 Mull Repair	43
Flush Fin Mull Components	44

100 Series Single-Hung Windows (2008 to Present)

Standard and Custom Windows

Parts Illustration

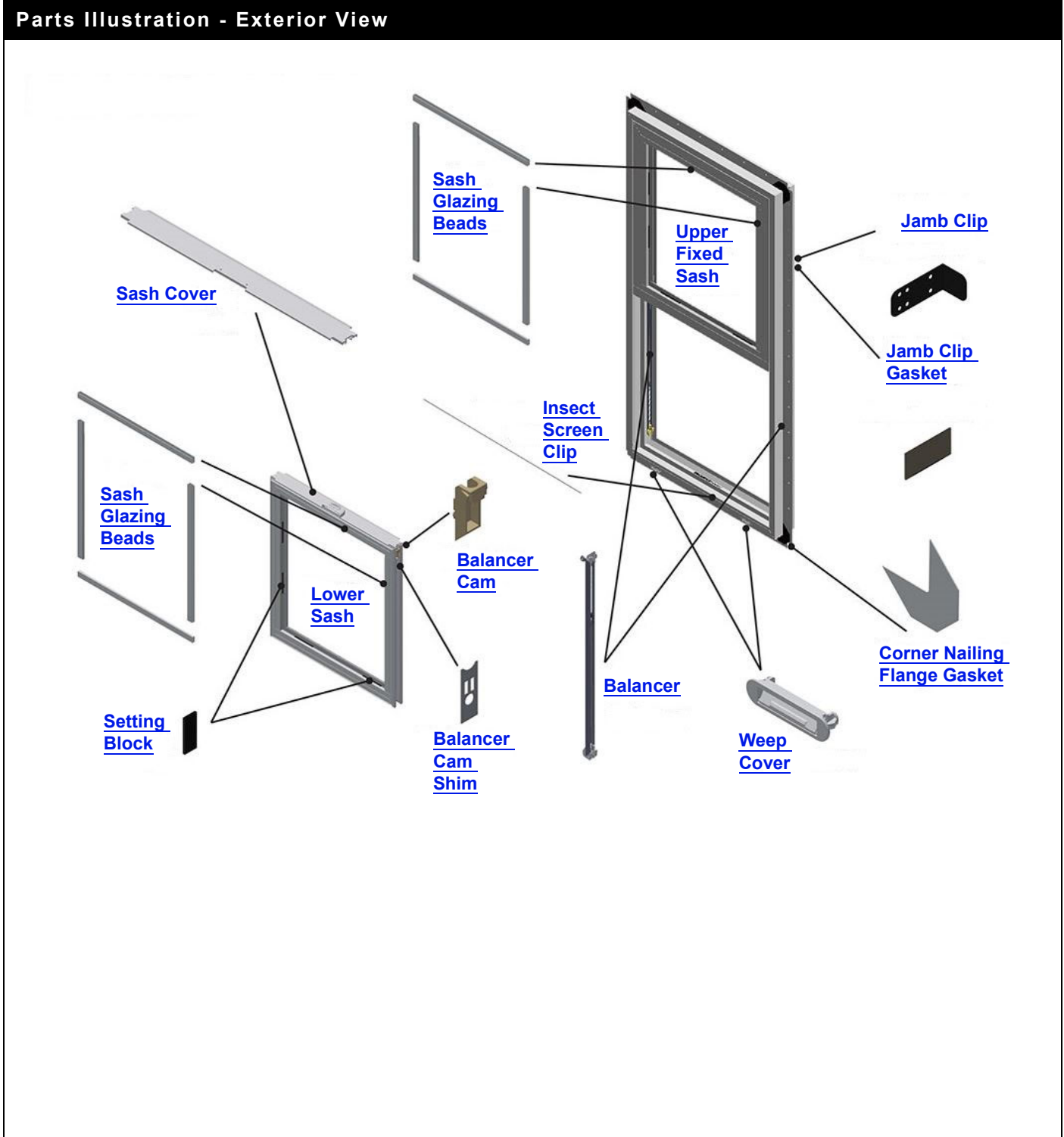

Parts Illustration

Parts Illustration - Interior View

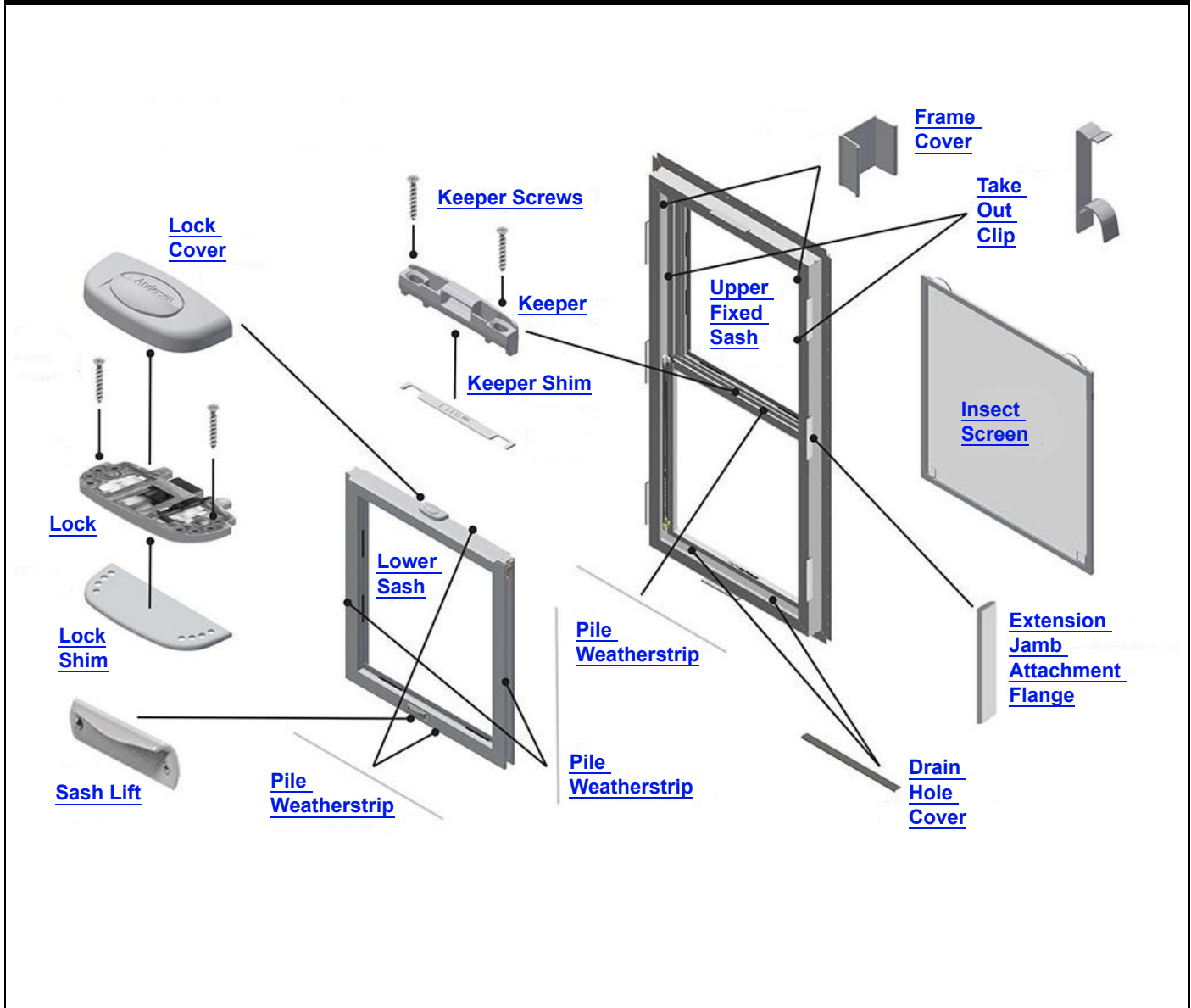

100 Series Single-Hung Windows (2008 to Present)

Standard and Custom Windows

Parts Illustration

Color Options Exterior

Note:

Cocoa Bean discontinued in June 2018.

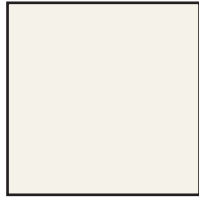

White



Sandtone



Terratone

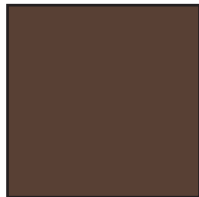

**Cocoa
Bean**



**Dark
Bronze**



Black

Color Options Interior



White



Sandtone



**Dark
Bronze**



Black

Unit Sizes

Standard and Custom Window Sizes

Note:

100 Series Single Hung Windows are available in standard sizes (see standard size charts, [page 7](#)). Replacement parts for some standard windows can be ordered using the numbers listed in this catalog. Many replacement parts for standard windows are made to order. These items are ordered using the Product ID found on the identification label and a description of the part needed. See [Service Guide 9051877](#).

100 Series Single Hung Windows are also available in custom sizes in 1/8" increments between the smallest and the largest standard sizes. Most replacement parts for custom-sized windows are made to order and can be ordered with the Product ID found on the identification label and a description of the part needed. See [Service Guide 9051877](#).

100 Series Product Label

Note:

Every 100 Series Single Hung Window will have an identification label **or** glass etching containing a unique Product ID. The Product ID on 100 Series Single Hung Windows will be located at the top of the window frame or etched into the glass. See [Service Guide 9051877](#). The Product ID may be up to 14 digits long (excluding hyphens), depending on the age of the unit. Replacement parts will also get their own unique Product ID. When ordering replacement parts, providing the Product ID ensures that replacement parts match the specifications.

100 Series Single-Hung Windows (2008 to Present)

Standard and Custom Windows

Unit Sizes

Unit Size Chart - Standard Windows

Note:

Unit Dimension refers to overall outside-to-outside frame. Unobstructed Glass refers to visible glass dimensions.

See unit [Product Details](#).

Window Dimension	1'-5 1/2" (445)	1'-11 1/2" (597)	2'-5 1/2" (749)	2'-11 1/2" (902)	3'-5 1/2" (1054)	3'-11 1/2" (1207)
Minimum Rough Opening	1'-6" (457)	2'-0" (610)	2'-6" (762)	3'-0" (914)	3'-6" (1067)	4'-0" (1219)
Unobstructed Glass (height of single sash)	11 1/4" (286)	17 1/4" (438)	23 1/4" (591)	29 1/4" (743)	35 1/4" (895)	41 1/4" (1048)

Window Dimension	CUSTOM WIDTHS—17 1/2" to 47 1/2"					
	1620	2020	2620	3020	3620	4020
1'-11 1/2" (597)						
2'-5 1/2" (749)						
2'-11 1/2" (902)						
3'-5 1/2" (1054)						
3'-11 1/2" (1207)						
4'-5 1/2" (1359)						
4'-11 1/2" (1511)						

Window Dimension	CUSTOM HEIGHTS—23 1/2" to 77 1/2"					
	1626	2026	2626	3026	3626	4026
2'-5 1/2" (749)						
2'-11 1/2" (902)						
3'-5 1/2" (1054)						
3'-11 1/2" (1207)						
4'-5 1/2" (1359)						
4'-11 1/2" (1511)						

Window Dimension	1630	2030	2630	3030	3630	4030	Reverse Cottage
2'-11 1/2" (902)							
3'-5 1/2" (1054)							
3'-11 1/2" (1207)							
4'-5 1/2" (1359)							
4'-11 1/2" (1511)							

Window Dimension	1636	2036	2636	3036	3636	4036
3'-5 1/2" (1054)						
3'-11 1/2" (1207)						
4'-5 1/2" (1359)						
4'-11 1/2" (1511)						

Window Dimension	1640	2040	2640	3040	3640	4040
3'-11 1/2" (1207)						
4'-5 1/2" (1359)						
4'-11 1/2" (1511)						

Window Dimension	1646	2046	2646	3046	3646	4046
4'-5 1/2" (1359)						
4'-11 1/2" (1511)						

Window Dimension	1650	2050	2650 [†]	3050 [†]	3650 [†]	4050 [†]
4'-11 1/2" (1511)						

continued on next page

100 Series Single-Hung Standard Window Sizes

- [100 Series - Arch Single-Hung](#)
- [100 Series Picture w/flanking Single-Hung](#)
- [100 Series - Single-Hung Reverse Cottage](#)
- [100 Series - Transoms - Single-Hung](#)
- [100 Series - Twin & Triple Hung](#)

Unit Sizes

Unit Size Chart - Standard Windows

Note:

Unit Dimension refers to overall outside-to-outside frame. Unobstructed Glass refers to visible glass dimensions.
See unit [Product Details](#).

Window Dimension	1'-5 1/2"	1'-11 1/2"	2'-5 1/2"	2'-11 1/2"	3'-5 1/2"	3'-11 1/2"
	(445)	(597)	(749)	(902)	(1054)	(1207)
Minimum Rough Opening	1'-6"	2'-0"	2'-6"	3'-0"	3'-6"	4'-0"
	(457)	(610)	(762)	(914)	(1067)	(1219)
Unobstructed Glass (height of single sash)	11 1/4"	17 1/4"	23 1/4"	29 1/4"	35 1/4"	41 1/4"
	(286)	(438)	(591)	(743)	(895)	(1048)

17 1/2" (445)
29 1/2" (749)

CUSTOM WIDTHS—17 1/2" to 47 1/2"

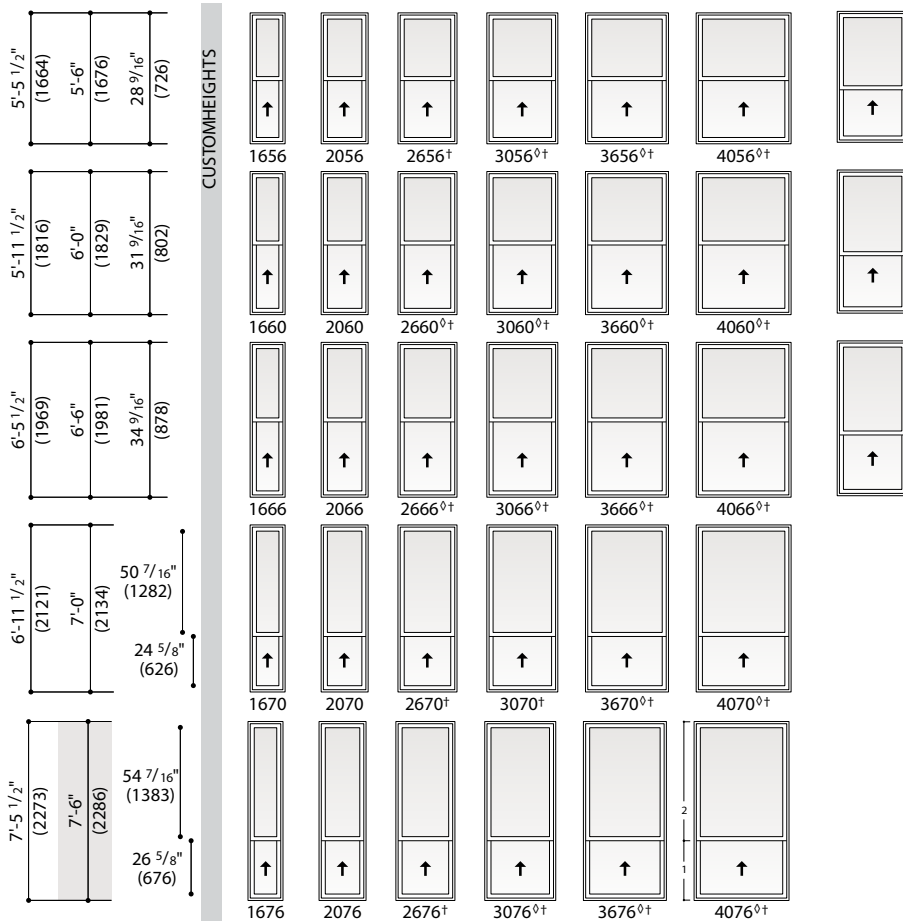

100 Series Single-Hung Standard Window Sizes

- [100 Series - Arch Single-Hung](#)
- [100 Series Picture w/flanking Single-Hung](#)
- [100 Series - Single-Hung Reverse Cottage](#)
- [100 Series - Transoms - Single-Hung](#)
- [100 Series - Twin & Triple Hung](#)

100 Series Single-Hung Windows (2008 to Present)

Standard and Custom Windows

Product History

Product History

- 2018** Cocoa Bean color discontinued.
- 2016** Slim Line (metal) hardware introduced.
- 2016** Dark Bronze exterior/interior color introduced.
- 2013** Black exterior and sandtone interior colors introduced.
- 2012** Extension jamb flanges introduced.
- 2011** Custom sizes introduced.
- 2010** Reverse Cottage (sash ratio 3:2) introduced.
- 2010** Drip cap for 1" stucco flange introduced.
- 2010** Sash lift/handle introduced.
- 2008** Single Hung Windows introduced.

Sash

Sash Illustration - Operating

Note:

Operating sash assembly shown. [Direct set glass](#) replacement for non operating glass.

Sash Ref. [page 4](#) & [page 3](#)

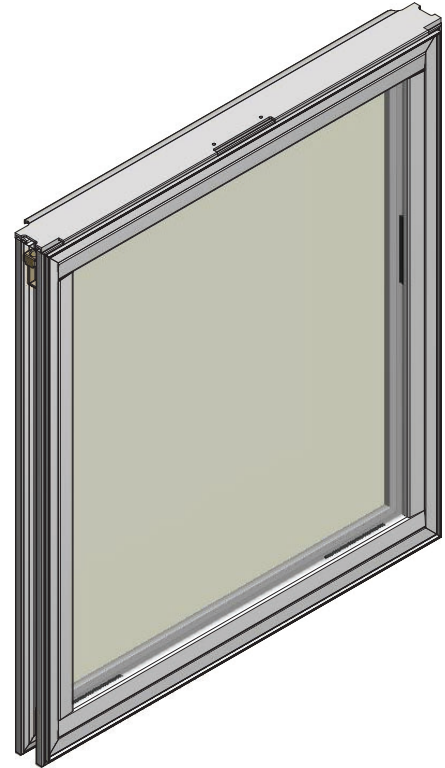
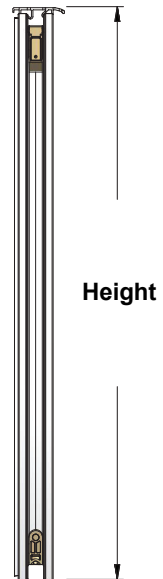

Sash Options - Operating

Sash

Glass Logo

Low-E



Low-E SmartSun™



Low-E HeatLock™



Low-E SmartSun™ HeatLock™



Tempered Logo

TEMPERED I/A
ANSI Z97.1-2009
SGCC XXXX
CIG-XX Xmm MM/DD/YR
CAN/CGSB 12.1-M90

Note:

Replacement operating sash for standard windows is made to order. Direct set glass used as replacement for non-operating glass. See iQ+ for inclusive detail for options. See sash [Product Details](#), [Service Guide 9000600](#) and [Replacement Video](#).

Exterior color options: White, Sandtone, Terratone, Cocoa Bean, Dark Bronze, Black

Interior finish options: White, Sandtone, Dark Bronze, Black

Glass options: (See Logo example): Twelve (12) primary glazing options. Glazings also available in an STC upgrade package. If tempered, logo can be located in any corner other than the AW logo location.

Low-E	Low-E Tempered	Low-E Obscure	Low-E Tempered Obscure
Low-E SmartSun™	Low-E SmartSun™ HeatLock	Low-E SmartSun™ Obscure	Low-E SmartSun™ Tempered Obscure
Low-E HeatLock	Low-E HeatLock Tempered	Low-E SmartSun™ HeatLock Tempered	Dual Pane Insulated

Grille types: Four (4) primary grille types

Finelight (Between the Glass)	Finelight (Between the Glass w/Exterior Grilles)	Full Divided Light	Simulated Divided Light

Grille patterns: Seven (7) primary grille patterns

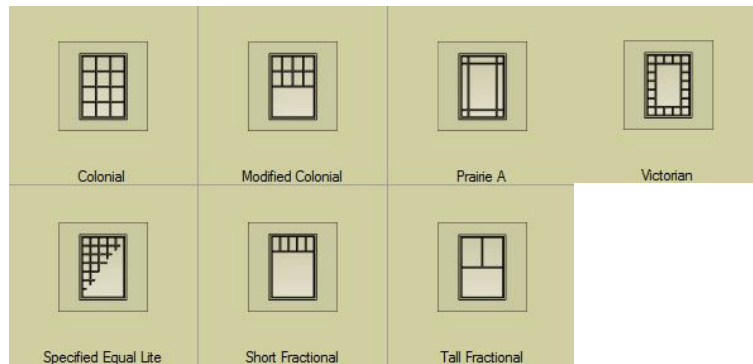

To order, state:

1. Description of part (Sash)
2. Product ID (from product label, see [Service Guide 9051877](#))
3. Manufactured date

Sash

Balancer Assembly

Balancer - Assembly

Note:

Balancers have length and counter-balance information stamped on face. The first one or two digits identify the approximate length and the second two digits identify a weight range. One sash uses two balancers. See [Replacement Video](#).

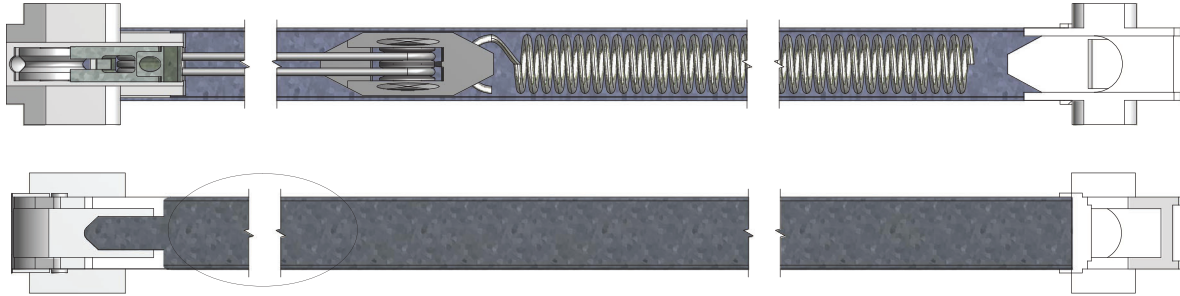

Note:

See part numbered balancers in [Balancer Chart](#).

To order, state:

1. Description of part (Balancer-Assembly)
2. Product ID (from product label, see [Service Guide 9051877](#))
3. Manufactured date

100 Series Single-Hung Windows (2008 to Present)

Standard and Custom Windows

Sash

Balancer Size Chart / Even

Note:

See [Service Guide 9000594](#) for balancer replacement. See FS00116 and FS00273 for additional detail.

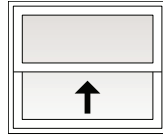

Even

Unit No.	Low E	Tempered	Order No.	Unit No.	Low E	Tempered	Order No.	Unit No.	Low E	Tempered	Order No.
	Balancer Size				Balancer Size				Balancer Size		
1620	810	810	See Chart	2620	820	820	See Chart	3620	820	840	See Chart
1626	1110	1120		2626	1120	1130		3626	1150	1150	
1630	1320	1320		2630	1330	1350		3630	1350	1360	
1636	1710	1720		2636	1720	1740		3636	1740	1760	
1640	1910	1920		2640	1930	1940		3640	1950	1960	
1646	2310	2320		2646	2320	2340		3646	2340	2350	
1650	2620	2620		2650	2630	2640		3650	2640	2650	
1656	2910	2920		2656	2930	2930		3656	2940	2960	
1660	3110	3120		2660	3130	3140		3660	3140	3165	
1666	3510	3520		2666	3530	3540		3666	3550	3560	
1670	2520	2520		2670	2530	2540		3670	2540	2560	
1676	2720	2720		2676	2730	2740		3676	2740	2760	
2020	810	810		3020	820	830		4020	840	850	
2026	1120	1120		3026	1130	1150		4026	1150	1160	
2030	1320	1330		3030	1350	1360		4030	1360	1365	
2036	1720	1720		3036	1740	1750		4036	1750	1765	
2040	1920	1930	3040	1940	1950	4040	1960	1970			
2046	2320	2320	3046	2340	2340	4046	2350	2365			
2050	2630	2630	3050	2640	2640	4050	2650	2665			
2056	2920	2930	3056	2930	2940	4056	2950	2965			
2060	3120	3130	3060	3140	3150	4060	3150	3170			
2066	3520	3530	3066	3540	3550	4066	3550	3570			
2070	2520	2530	3070	2540	2540	4070	2550	2565			
2076	2730	2730	3076	2740	2740	4076	2750	2765			

Sash

Balancer Size Chart / Reverse Cottage 3 over 2

Note:

See [Service Guide 9000594](#) for balancer replacement. See FS00129 and FS00273 for additional detail.

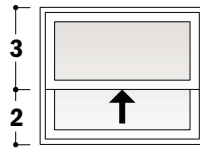

Reverse Cottage

Unit No.	Low E	Tempered	Order No.	Unit No.	Low E	Tempered	Order No.	Unit No.	Low E	Tempered	Order No.
	Balancer Size				Balancer Size				Balancer Size		
1626	810	810	See Chart	2626	820	820	See Chart	3626	830	840	See Chart
1630	1110	1120		2630	1120	1130		3630	1150	1160	
1636	1310	1320		2636	1330	1350		3636	1350	1360	
1640	1520	1520		2640	1530	1550		3640	1550	1560	
1646	1910	1920		2646	1930	1940		3646	1950	1960	
1650	2120	2120		2650	2130	2140		3650	2140	2150	
1656	2310	2320		2656	2330	2340		3656	2340	2350	
1660	2620	2620		2660	2630	2640		3660	2640	2650	
1666	2720	2720		2666	2730	2740		3666	2740	2760	
2026	810	820		3026	830	830		4026	840	850	
2030	1120	1120		3030	1130	1150		4030	1150	1160	
2036	1320	1330		3036	1350	1350		4036	1360	1365	
2040	1520	1530		3040	1550	1550		4040	1560	1565	
2046	1920	1930		3046	1940	1950		4046	1950	1965	
2050	2120	2130		3050	2140	2140		4050	2140	2160	
2056	2320	2320		3056	2340	2340		4056	2350	2365	
2060	2620	2630	3060	2640	2640	4060	2650	2665			
2066	2730	2730	3066	2740	2750	4066	2750	2765			

100 Series Single-Hung Windows (2008 to Present)

Standard and Custom Windows

Sash

Balancer Chart

Note:

Balancers have length and counter-balance information stamped on face. The first one or two digits identify the approximate length and the second two digits identify a weight range (ie a 2050 balancer number is 20 inches long and a pair will counterbalance 50 pounds. See PD 228).

*Balancers marked as N/A use next longer length (ie SH710 uses SH 810. SH 910 uses SH 1010). Unit heights between 23.50 and 25.75 will use 8 inch balancers. Unit heights between 25.875 and 27.75 will use 10 inch balancers. Replace both balancers.

7" - 21"

Balancer No.	Order No.	Balancer No.	Order No.	Balancer No.	Order No.
SH710	N/A*	SH1365	9122997	SH1850	9123033
SH720	N/A*	SH1410	9122998	SH1860	9123034
SH730	N/A*	SH1420	9122999	SH1865	9123035
SH810	9123217	SH1430	9123000	SH1870	9123036
SH820	9123218	SH1440	9123001	SH1875	9123037
SH830	9123219	SH1450	9123002	SH1880	9123038
SH840	9123220	SH1460	9123003	SH1910	9123039
SH850	9179499	SH1465	9123004	SH1920	9123040
SH910	N/A*	SH1510	9123005	SH1930	9123041
SH920	N/A*	SH1520	9123006	SH1940	9123042
SH930	N/A*	SH1530	9123007	SH1950	9123043
SH940	N/A*	SH1540	9123008	SH1960	9123044
SH1010	9122974	SH1550	9123009	SH1965	9123045
SH1020	9122975	SH1560	9123010	SH1970	9123046
SH1030	9122976	SH1565	9123011	SH1975	9123047
SH1040	9122977	SH1570	9123012	SH1980	9123048
SH1050	9122978	SH1610	9123013	SH1985	9123049
SH1060	9179498	SH1620	9123014	SH2010	9123050
SH1110	9122979	SH1630	9123015	SH2020	9123051
SH1120	9122980	SH1640	9123016	SH2030	9123052
SH1130	9122981	SH1650	9123017	SH2040	9123053
SH1140	9122982	SH1660	9123018	SH2050	9123054
SH1150	9122983	SH1665	9123019	SH2060	9123055
SH1160	9122984	SH1710	9123020	SH2065	9123056
SH1210	9122985	SH1720	9123021	SH2070	9123057
SH1220	9122986	SH1730	9123022	SH2075	9123058
SH1230	9122987	SH1740	9123023	SH2110	9123059
SH1240	9122988	SH1750	9123024	SH2120	9123060
SH1250	9122989	SH1760	9123025	SH2130	9123061
SH1260	9122990	SH1765	9123026	SH2140	9123062
SH1310	9122991	SH1770	9123027	SH2150	9123063
SH1320	9122992	SH1775	9123028	SH2160	9123064
SH1330	9122993	SH1810	9123029	SH2165	9123065
SH1340	9122994	SH1820	9123030	SH2170	9123066
SH1350	9122995	SH1830	9123031	SH2175	9123067
SH1360	9122996	SH1840	9123032		

Sash

Balancer Chart

Note:

Balancers have length and counter-balance information stamped on face. The first one or two digits identify the approximate length and the second two digits identify a weight range (ie a 3050 balancer number is 30 inches long and a **pair** will counterbalance 50 pounds. See PD 228).

22" - 32"

Balancer No.	Order No.	Balancer No.	Order No.	Balancer No.	Order No.
SH2210	9123068	SH2565	9123103	SH2920	9123138
SH2220	9123069	SH2570	9123104	SH2930	9123139
SH2230	9123070	SH2575	9123105	SH2940	9123140
SH2240	9123071	SH2580	9123106	SH2950	9123141
SH2250	9123072	SH2585	9123107	SH2960	9123142
SH2260	9123073	SH2610	9123108	SH2965	9123143
SH2265	9123074	SH2620	9123109	SH2970	9123144
SH2270	9123075	SH2630	9123110	SH2975	9123145
SH2275	9123076	SH2640	9123111	SH3010	9123146
SH2310	9123077	SH2650	9123112	SH3020	9123147
SH2320	9123078	SH2660	9123113	SH3030	9123148
SH2330	9123079	SH2665	9123114	SH3040	9123149
SH2340	9123080	SH2670	9123115	SH3050	9123150
SH2350	9123081	SH2675	9123116	SH3060	9123151
SH2360	9123082	SH2680	9123117	SH3065	9123152
SH2365	9123083	SH2710	9123118	SH3070	9123153
SH2370	9123084	SH2720	9123119	SH3075	9123154
SH2375	9123085	SH2730	9123120	SH3110	9123155
SH2410	9123086	SH2740	9123121	SH3120	9123156
SH2420	9123087	SH2750	9123122	SH3130	9123157
SH2430	9123088	SH2760	9123123	SH3140	9123158
SH2440	9123089	SH2765	9123124	SH3150	9123159
SH2450	9123090	SH2770	9123125	SH3160	9123160
SH2460	9123091	SH2775	9123126	SH3165	9123161
SH2465	9123092	SH2780	9123127	SH3170	9123162
SH2470	9123093	SH2810	9123128	SH3175	9123163
SH2475	9123094	SH2820	9123129	SH3210	9123164
SH2480	9123095	SH2830	9123130	SH3220	9123165
SH2485	9123096	SH2840	9123131	SH3230	9123166
SH2510	9123097	SH2850	9123132	SH3240	9123167
SH2520	9123098	SH2860	9123133	SH3250	9123168
SH2530	9123099	SH2865	9123134	SH3260	9123169
SH2540	9123100	SH2870	9123135	SH3265	9123170
SH2550	9123101	SH2875	9123136	SH3270	9123171
SH2560	9123102	SH2910	9123137	SH3275	9123172

100 Series Single-Hung Windows (2008 to Present)

Standard and Custom Windows

Sash

Balancer Chart

Note:

Balancers have length and counter-balance information stamped on face. The first one or two digits identify the approximate length and the second two digits identify a weight range (ie a 3550 balancer number is 35 inches long and a **pair** will counterbalance 50 pounds. See PD 228).

33" - 37"

Balancer No.	Order No.	Balancer No.	Order No.	Balancer No.	Order No.
SH3310	9123173	SH3460	9123187	SH3640	9123201
SH3320	9123174	SH3465	9123188	SH3650	9123202
SH3330	9123175	SH3470	9123189	SH3660	9123203
SH3340	9123176	SH3510	9123190	SH3665	9123204
SH3350	9123177	SH3520	9123191	SH3670	9123205
SH3360	9123178	SH3530	9123192	SH3710	9123206
SH3365	9123179	SH3540	9123193	SH3720	9123207
SH3370	9123180	SH3550	9123194	SH3730	9123208
SH3375	9123181	SH3560	9123195	SH3740	9123209
SH3410	9123182	SH3565	9123196	SH3750	9123210
SH3420	9123183	SH3570	9123197	SH3760	9123211
SH3430	9123184	SH3610	9123198	SH3765	9123212
SH3440	9123185	SH3620	9123199	SH3770	9123213
SH3450	9123186	SH3630	9123200		

Balancer Parts

Balancer Cam Shim

Note:

One shim.

		Order No.
		9130538

Balancer Cam Shim Screw

Note:

3/8" screw.

		Order No.
		9123372

Sash

Sash Hardware / Lifts												
Sash Lift												
Note: Kit includes lift, fasteners, and grommets. See Accessory Guide 9041680 .												
		<table border="1"> <thead> <tr> <th>Color</th> <th>Order No.</th> </tr> </thead> <tbody> <tr> <td>White</td> <td>9130443</td> </tr> <tr> <td>Sandtone</td> <td>9130444</td> </tr> <tr> <td>Dark Bronze</td> <td>9144648</td> </tr> <tr> <td>Black</td> <td>9144649</td> </tr> </tbody> </table>	Color	Order No.	White	9130443	Sandtone	9130444	Dark Bronze	9144648	Black	9144649
	Color	Order No.										
	White	9130443										
	Sandtone	9130444										
	Dark Bronze	9144648										
Black	9144649											

Sash Hardware / Lock Kits/Components																
Lock Cover (2007 - present)																
		<table border="1"> <thead> <tr> <th>Color</th> <th>Order No.</th> </tr> </thead> <tbody> <tr> <td>White</td> <td>9046293</td> </tr> <tr> <td>Sandtone</td> <td>9123299</td> </tr> <tr> <td>Dark Bronze</td> <td>9144579</td> </tr> <tr> <td>Black</td> <td>9144580</td> </tr> </tbody> </table>	Color	Order No.	White	9046293	Sandtone	9123299	Dark Bronze	9144579	Black	9144580				
	Color	Order No.														
	White	9046293														
	Sandtone	9123299														
	Dark Bronze	9144579														
Black	9144580															
Lock Cover / Metal (Slim Line) (10/2016 - present)																
		<table border="1"> <thead> <tr> <th>Color</th> <th>Order No.</th> </tr> </thead> <tbody> <tr> <td>White</td> <td>9144682</td> </tr> <tr> <td>Sandtone</td> <td>9144683</td> </tr> <tr> <td>Dark Bronze</td> <td>9144684</td> </tr> <tr> <td>Black</td> <td>9144685</td> </tr> <tr> <td>Antique Brass</td> <td>9144686</td> </tr> <tr> <td>Satin Nickel</td> <td>9144687</td> </tr> </tbody> </table>	Color	Order No.	White	9144682	Sandtone	9144683	Dark Bronze	9144684	Black	9144685	Antique Brass	9144686	Satin Nickel	9144687
	Color	Order No.														
	White	9144682														
	Sandtone	9144683														
	Dark Bronze	9144684														
	Black	9144685														
Antique Brass	9144686															
Satin Nickel	9144687															
Lock Cover - Reach Range																
		<table border="1"> <thead> <tr> <th>Color</th> <th>Order No.</th> </tr> </thead> <tbody> <tr> <td>White</td> <td>9130383</td> </tr> <tr> <td>Sandtone</td> <td>9130384</td> </tr> <tr> <td>Dark Bronze</td> <td>9144639</td> </tr> <tr> <td>Black</td> <td>9144640</td> </tr> </tbody> </table>	Color	Order No.	White	9130383	Sandtone	9130384	Dark Bronze	9144639	Black	9144640				
	Color	Order No.														
	White	9130383														
	Sandtone	9130384														
	Dark Bronze	9144639														
Black	9144640															

Lock and Keeper Kit with Screws												
Note: See Service Guide 9000593 for lock and keeper replacement. Keeper matches interior color of unit. Cover not included.												
		<table border="1"> <thead> <tr> <th>Color</th> <th>Order No.</th> </tr> </thead> <tbody> <tr> <td>White</td> <td>9130388</td> </tr> <tr> <td>Sandtone</td> <td>9130389</td> </tr> <tr> <td>Dark Bronze</td> <td>9144643</td> </tr> <tr> <td>Black</td> <td>9144644</td> </tr> </tbody> </table>	Color	Order No.	White	9130388	Sandtone	9130389	Dark Bronze	9144643	Black	9144644
Color	Order No.											
White	9130388											
Sandtone	9130389											
Dark Bronze	9144643											
Black	9144644											

100 Series Single-Hung Windows (2008 to Present)



Standard and Custom Windows

Sash

Screw - Keeper Ref. page 4			
Note: Keeper uses two.			
	Description	Color	Order No.
	6-10 x 1" PH OVL PLASK SC white #2M ZC	White	0873298
		Sandtone	9123379
		Dark Bronze	9144556
Black		9144557	

Screw - Lock Ref. page 4			
	Description	Color	Order No.
	#6-10 x 1" PH Undersized # 5 FH Tapping	Stainless Steel	N/A

Sash

Shim Kits/Components			
Spacers - Keeper Shim			
		Color	Order No.
		White	9130537
		Sandtone	9130534
Spacers - Lock Shim			
		Color	Order No.
		White	9130535
		Sandtone	9130536
		Dark Bronze	9144659
		Black	9144660

Sash Components - Miscellaneous		
Cam		
Note: See Service Guide 9000592 for sash replacement.		
		Order No.
		9046297

Glazing Beads	
Glazing Bead	
	Note: Replacement glazing beads are made to order. <i>To order, state:</i> <ol style="list-style-type: none"> 1. Description of part (Glazing Bead) 2. Unit size and handing 3. Orientation of replacement part (top, bottom, left or right). Each piece must be ordered separately 4. Product ID (from product label, see Service Guide 9051877) 5. Manufactured date

Glass

Glass Only Ref. [page 4](#) & [page 3](#)

Glass Logo

Low-E



Low-E SmartSun™



Low-E HeatLock™



Low-E SmartSun™ HeatLock™



Tempered Logo

TEMPERED
16 CFR 1201 II
ANSI Z97.1 2009
S GCC XXXX
CIG-XX Xmm MM/YYR
CAN/CGSB 12.1-M90

Note:

Stationary/fix sash do not use replacement sash. Order direct set glass. Glass ships with [glazing bead](#). See [Service Guide 9000597](#) for glass replacement.

Glass options: (See [Logo examples](#)): Twelve (12) primary glazing options. Glazings also available in an STC upgrade package. If tempered, logo can be located in any corner other than the AW logo location.

Low-E	Low-E Tempered	Low-E Obscure	Low-E Tempered Obscure
Low-E SmartSun™	Low-E SmartSun™ HeatLock	Low-E SmartSun™ Obscure	Low-E SmartSun™ Tempered Obscure
Low-E HeatLock	Low-E HeatLock Tempered	Low-E SmartSun™ HeatLock Tempered	Dual Pane Insulated

Grille types: Four (4) primary grille types

Finelight (Between the Glass)	Finelight (Between the Glass w/Exterior Grilles)	Full Divided Light	Simulated Divided Light

Grille patterns: Seven (7) primary grille patterns

Colonial	Modified Colonial	Prairie A	Victorian
Specified Equal Lite	Short Fractional	Tall Fractional	

To order, state:

1. Description of part (Glass)
2. Product ID (from product label, see [Service Guide 9051877](#))
3. Manufactured date

Insect Screen

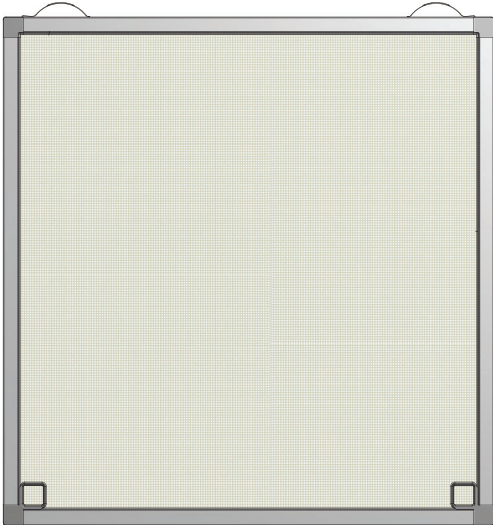
Insect Screen	
Insect Screen Assembly	
	<p>Note: Replacement screens are made to order. Screens manufactured after October 24, 2016 will use charcoal mesh. Prior to this date silver mesh was used. See Dealer Bulletin 60-16 for more details.</p> <p>TruScene® mesh uses unique (rubber) screen pull.</p> <p><i>To order, state:</i></p> <ol style="list-style-type: none"> 1. Generic order #9000405 2. Product ID (from product label, see Service Guide 9051877) 3. Manufacturing date, product description, manufacturing instructions.

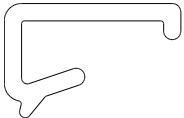
Insect Screen Parts	
Clip / Retainer - Insect Screen	
	<p>Note: Replacement screen retainer clips are made to order. Located on side jamb.</p> <p><i>To order, state:</i></p> <ol style="list-style-type: none"> 1. Product ID (from product label, see Service Guide 9051877) 2. Unit dimension (w x h) 3. Manufacturing date and product description

100 Series Single-Hung Windows (2008 to Present)

Standard and Custom Windows

Hardware

Hardware Parts		
Clip - Take-Out		
Note: Quantity of one. Part sits in side jamb. See Service Guide 9000595 for clip replacement. See Replacement Video .		
		Order No.
		9122973

Fasteners			
Installation Screw Kit			
Note: Quantity of eight screws. Used to install flangeless unit frame and insert unit frame of gliding and single-hung windows.			
	Description	Color	Order No.
	#8 x 3" Bugle Head, Coarse Thread	White	9179703
		Sandtone	9179704
		Dark Bronze	9179705
		Black	9179706

Installation Screw Pack - Flush Fin (April 2023 - Present)			
Note: Quantity of eight screws. Used to install flush fin units.			
		Color	Order No.
		White	9184765
		Sandtone	9184766
		Dark Bronze	9184767
		Black	9184768

Installation Clip Kit (February 2023 - Present)		
Note: Kit includes installation clip, plastisol coated screws, gasket and instruction guide. Used to secure unit.		
		Order No.
		9179715

Hardware

Drywall Kit

Screw

Note:

Used for sash removal and re-installation. See [Installation Guide 9054263](#).

	Kit Includes:	Order No.
	(1) Hex Wrench (2) Cup Washer (2) Fixed Sash Head Screw (2) Fixed Sash Bottom Rail Screw Installation Guide	9123337

100 Series Single-Hung Windows (2008 to Present)

Standard and Custom Windows

Frames

Frame Assembly

Note:

See frame [Product Details](#).

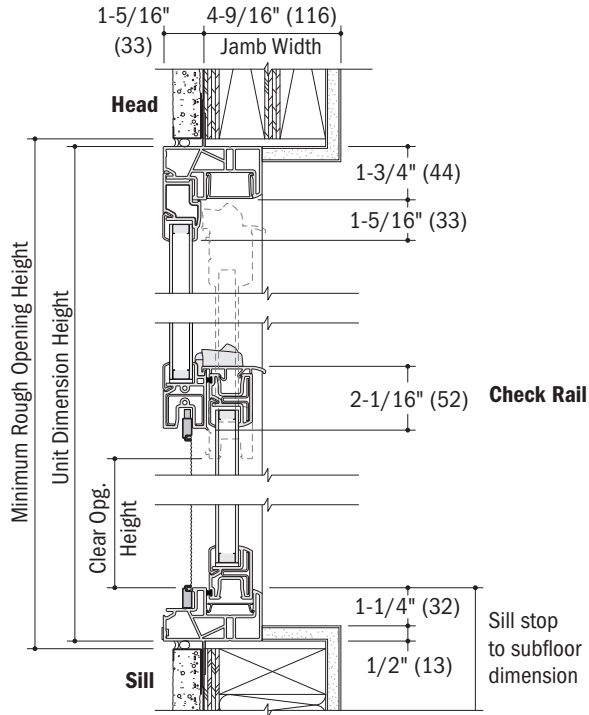

**Vertical Section
Single-Hung Window**

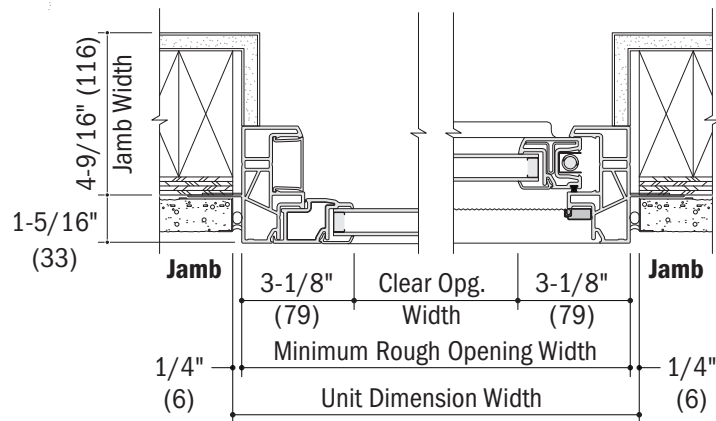

**Horizontal Section
Single-Hung Window**

100 Series Single-Hung Window Frame Assembly

Frames

Frames
Frame
Note: Replacement frames are not available. Replace complete unit assembly.

Exterior Trim Components	
1" Exterior Frame / Sill Extender Trim Kit	
	<p>Note: Replacement exterior frame/sill extender trim kits are made to order.</p> <p><i>To order, state:</i></p> <ol style="list-style-type: none"> 1. Generic order #9000405 2. Product ID (from product label, see Service Guide 9051877) 3. Manufacturing date and product description

1" Exterior Frame / Sill Extender Trim / Lineal Lengths				
Note: See Installation Guide 9183351 .				
		Color	PVC	
				72"
		White	9179668	9179673
		Terratone®	9179670	9179675
		Sandtone	9179669	9179674
		Dark Bronze	9179671	9179676
Black	9179672	9179677		

2" Exterior Frame / Sill Extender Trim / Lineal Lengths				
Note: See Installation Guide 9183351 .				
		Color	Fibrex	
				72"
		White	9199138	9199143
		Terratone®	9199142	9199147
		Sandtone	9199141	9199146
		Dark Bronze	9199140	9199145
Black	9199139	9199144		

Head Expander				
Note: See Installation Guide 9183352 .				
	Exterior Color	Interior Color	Length	Order No.
				White
	Dark Bronze	Dark Bronze	48"	9199149
	Black	Black		9199148
	Dark Bronze	White	9199150	
	Black	White	9199151	

100 Series Single-Hung Windows (2008 to Present)

Standard and Custom Windows

Frames

Frame Hardware / Opening Control Device

Opening Control Device Kit

Note:

Kit includes one opening control device, one back plate and screws. Handing determined by location on unit as viewed from exterior. See [Accessory Guide 9040336](#).

			Order No.	
		Color	LH	RH
		White	9130514	9130515
		Sandtone	9130516	9130517
		Black	9144657	9144658

Frames

Frame Components / Miscellaneous			
Cover - Frame			
		Color	144"
		White	9130386
		Sandtone	9130387
		Dark Bronze	9144641
		Black	9144642

Cover - Drain Hole	
	<p>Note: Replacement Drain Hole Covers are made to order. <i>To order, state:</i></p> <ol style="list-style-type: none"> 1. Description of part (Cover- Drain Hole) 2. Product ID (from product label, see Service Guide 9051877) 3. Manufactured date 4. Color

Sash Stop			
		Color	1 1/2"
		White	9125974
		Sandtone	9125976
		Dark Bronze	9144627
		Black	9144628

Clip - Insect Screen	
	<p>Note: Replacement screen clips are made to order. Located on sill. <i>To order, state:</i></p> <ol style="list-style-type: none"> 1. Description of part (Clip- Insect Screen) 2. Product ID (from product label, see Service Guide 9051877) 3. Unit dimension (w x h) 4. Manufactured date

Sloped Sill Adaptor				
		Color	Order No.	
			48"	96"
		White	9130539	9130545
		Terratone®	9130544	9130550
		Sandtone	9130543	9130549
		Cocoa Bean	9130541	9130547
		Dark Bronze	9130542	9130548
Black	9130540	9130546		

100 Series Single-Hung Windows (2008 to Present)

Standard and Custom Windows

Frames

Clip - Take-Out		
Note: Quantity of one. Part sits in side jamb. See Service Guide 9000595 for clip replacement. See Replacement Video .		
		Order No. 9122973

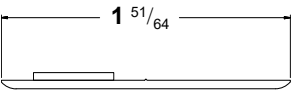

Gasket - Corner Nailing Flange		
		Order No. 9046291

Weep Cover - Frame Assembly			
		Color White	Order No. 9123290
		Terratone®	9123294
		Sandtone	9123293
		Cocoa Bean	9123291
		Dark Bronze	9123292
		Black	9123289

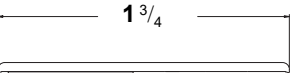
Extension Jamb Attachment Flange		
Note: Quantity of 50. See Accessory Guide 9064334 .		
		Order No. 9130438

Flush Fin Interior Flat Trim - Straight <i>(April 2023 - Present)</i>			
Note: Used to trim out gap between flush fin units and interior wall returns. Cut to size.			
		Color White	Order No. 9199357
		Sandtone	9199360
		Dark Bronze	9199359
		Black	9199358
		Length 144"	

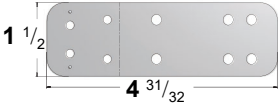
Frames

Jamb Clip		Order No.
		9123272
Gasket - Jamb Clip		Order No.
		9123316

100 Series Single-Hung Windows (2008 to Present)

Standard and Custom Windows

Joining Components

Joining Components - All Mull Systems

Note:

The following kits & components are used in **all** mull systems (non-reinforced, reinforced, easy connect). Refer to mulling installation guides for additional detail.

Exterior / Interior Trim (August 2019 - Present)

Note:

See [page 38](#) for previous vintage.

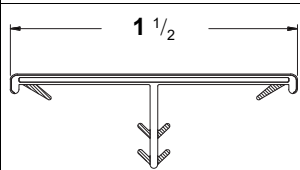

Color	60"	72"	96"	144"
Exterior White	9178715	9178716	9178717	9178718
Exterior Terratone®	-	-	9178729	9178730
Exterior Sandtone	-	-	9178719	9178720
Exterior Dark Bronze	9178725	9178726	9178727	9178728
Exterior Black	9178721	9178722	9178723	9178724

End Cap (August 2019 - Present)

Note:

Used in 1 3/8" standard and flangeless frames.

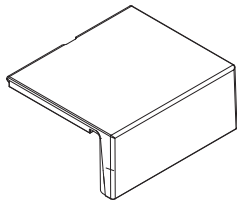

Color	Order No.
White	9178738
Terratone®	9178742
Sandtone	9178739
Dark Bronze	9178741
Black	9178740

End Cap - Stucco Key (May 2021 - Present)

Note:

Used in 1" stucco frame.

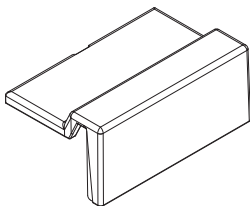

Color	Order No.
White	9185998
Terratone®	9186002
Sandtone	9185999
Dark Bronze	9186001
Black	9186000

Joining Components

Gasket - Nailing Flange	
Note: Used to create a continuous installation flange across mullied units.	
	Order No. 9198343

Screw - Gusset Plate	
Note: Used to fasten reinforced, easy connect and non-reinforced gusset plates.	
	Description #8 x 3/4" Flat Head
	Order No. 9199428

End Cap Kit (August 2019 - Present)		
Note: Kit includes two end caps and two flange gaskets. Used for end sealing mull joins.		
		Color Order No.
		White 9180195 Terratone® 9180199 Sandtone 9180198 Dark Bronze 9180197 Black 9180196

End Cap Kit - Stucco Key (May 2021 - Present)		
Note: Kit includes two end caps and two flange gaskets. Used for end sealing mull joins.		
		Color Order No.
		White 9186537 Terratone® 9186541 Sandtone 9186540 Dark Bronze 9186539 Black 9186538

100 Series Single-Hung Windows (2008 to Present)

Standard and Custom Windows

Joining Components

Non-Reinforced Joining Components (August 2019 - Present)

Note:

Contains non-reinforced components for one-way non-reinforced joining and non-reinforced portion of two-way joins. See [Joining Guide 9014080](#) for one-way non-reinforced joining. See [Joining Guide 9179728](#) and [Joining Guide 9179729](#) for two-way joining.

Kits are configured through iQ+. See [Drip Cap](#) options.

Window Mull Hardware Kit (August 2019 - Present)

Note:

Complete hardware kit for one-way non-reinforced joining only. Used in 1 3/8" standard and flangeless frames.

	Hardware Kit Includes: (2) Gusset Plates (2) End Caps (2) Flange Gaskets Fasteners Joining Guide 9014080	Color	Order No.			
			Interior White	Interior Sandtone	Interior Dark Bronze	Interior Black
		Exterior White	9180575	9180573	-	-
		Exterior Terratone®	9180579	-	-	-
		Exterior Sandtone	9180578	9180574	-	-
		Exterior Dark Bronze	9180577	-	9180580	-
		Exterior Black	9180576	-	-	9180581

Window Mull Hardware Kit - Stucco Frame (May 2021 - Present)

Note:

Complete hardware kit for one-way non-reinforced joining only. Used in 1" stucco key frames.

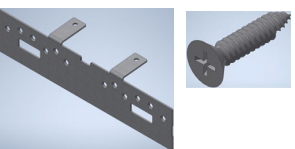

	Hardware Kit Includes: (2) Gusset Plates (2) Stucco Key End Caps (2) Flange Gaskets Fasteners Joining Guide 9014080	Color	Order No.			
			Interior White	Interior Sandtone	Interior Dark Bronze	Interior Black
		Exterior White	9186543			
		Exterior Terratone®	9186547			
		Exterior Sandtone	9186546	9186542		
		Exterior Dark Bronze	9186545		9186548	
		Exterior Black	9186544			9186549

Gusset Plate Kit (June 2023 - Present)

	Kit Includes: (2) Gusset Plates (24) Fasteners	Order No.
		9180201

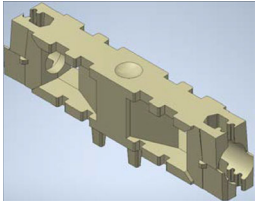
Joining Components

Non-Reinforced Plug Kit (August 2019 - Present)	
Note: Used in two-way joining only. Includes non-reinforced plugs, two way joining part and installation guide.	
	Order No.
	9180200

Screw - Joining Kit (2012 - Present)									
Note: Kit includes 16 -2 inch & 16 -2-3/4 inch fasteners. Used when joining units together through fiberglass joining strip.									
 #8 x 2" Bugle Head Screw  #8 x 2-3/4" Bugle Head Screw	Order No.								
	<table border="1"> <thead> <tr> <th>White</th> <th>Sandtone</th> <th>Dark Bronze</th> <th>Black</th> </tr> </thead> <tbody> <tr> <td>9180202</td> <td>9180205</td> <td>9180204</td> <td>9180203</td> </tr> </tbody> </table>	White	Sandtone	Dark Bronze	Black	9180202	9180205	9180204	9180203
	White	Sandtone	Dark Bronze	Black					
9180202	9180205	9180204	9180203						

Screw - Joining (2012 - Present)													
Note: Individual screws used when joining units together through fiberglass joining strip.													
Description	Order No.												
	<table border="1"> <thead> <tr> <th>White</th> <th>Sandtone</th> <th>Dark Bronze</th> <th>Black</th> </tr> </thead> <tbody> <tr> <td>9123376</td> <td>9123377</td> <td>9144615</td> <td>9144616</td> </tr> <tr> <td>9123374</td> <td>9123375</td> <td>9144613</td> <td>9144614</td> </tr> </tbody> </table>	White	Sandtone	Dark Bronze	Black	9123376	9123377	9144615	9144616	9123374	9123375	9144613	9144614
	White	Sandtone	Dark Bronze	Black									
9123376	9123377	9144615	9144616										
9123374	9123375	9144613	9144614										
<table border="1"> <tbody> <tr> <td>#8 x 2 3/4" Bugle Head</td> <td></td> </tr> <tr> <td>#8 x 2" Bugle Head HD</td> <td></td> </tr> </tbody> </table>	#8 x 2 3/4" Bugle Head		#8 x 2" Bugle Head HD										
#8 x 2 3/4" Bugle Head													
#8 x 2" Bugle Head HD													

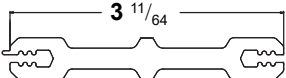
Fiberglass Joining Strip - 95" Piece	
Note: Structural piece of the non-reinforced mull system used to join two units.	
	Order No.
	9123342

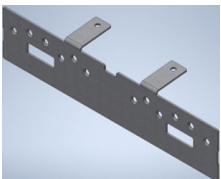
Gusset Plate (June 2023 - Present)	
	Order No.
	9199429

100 Series Single-Hung Windows (2008 to Present)

Standard and Custom Windows

Joining Components

Reinforced Joining Components (August 2019 - Present)

Note:

See [Joining Guide 9179729](#). Kits are configured through iQ+. See [Drip Cap](#) options.

Joining Plate - Fiberglass (August 2019 - Present)

Note:

Structural mull component of the reinforced mull system that joins two units (one-way) or combination of units (two-way) together.

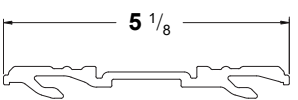
		Size	Order No.
		94 1/2	9178731
		118 1/2	9178732
		142 1/2	9178733

Alignment Spacer (August 2019 - Present)

Note:

Used to locate the joining plates on unit or combination.

		Size	Order No.
		144	9178736

Interior Cover (August 2019 - Present)

Note:

Used to cover the interior of the reinforced join.

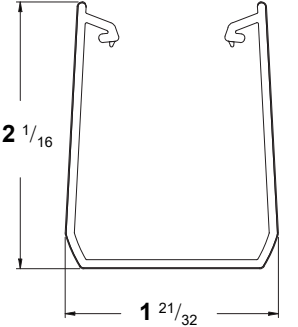
		Color	72"	96"	144"
		White	9178751	9178754	9178758
		Sandtone	-	9178755	9178759
		Dark Bronze	9178753	9178757	9178761
		Black	9178752	9178756	9178760

Gusset Plate (August 2019 - Present)

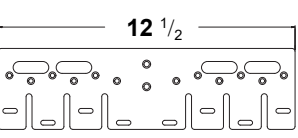

Note:

Used for factory assembled reinforced joins or field assembled reinforced joins.

		Type	Order No.
		Standard	9178743

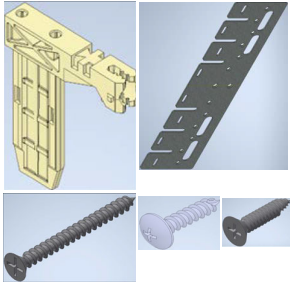
Joining Components

Hardware Kit - Reinforced Joining		
<p>Note: Used in Reinforced Two-Way joins. See Joining Guide 9179729.</p>		
	<p>Kit Includes:</p> <ul style="list-style-type: none"> (2) Reinforced Plug (2) Flat Gussets (24) #8 x 3/4" Flat Head Screws (4) #10 x 2" Flat Head Screws (32) #10 x 7/8" Truss Head Screws 	<p>Order No. 9180206</p>

Screw - Joining		
	Description	Order No.
	#10 x 2" Flat Head	3621400
	#10-12 x 7/8" Truss Head	9178737

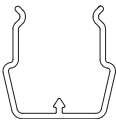
Bar - Stiffener (August 2019 - Present)		
<p>Note: Used in Reinforced Mull Kits.</p>		
		<p>Order No. 9178746</p>

100 Series Single-Hung Windows (2008 to Present)

Standard and Custom Windows

Joining Components

Reinforced Easy Connect Joining Components (August 2019 - Present)

Note:

See [Joining Guide 9183919](#). These are components specific to Easy Connect joining only. Review above sections for additional compatible mull components. See [Drip Cap](#) options.

Easy Connect Join-In-Opening Kit

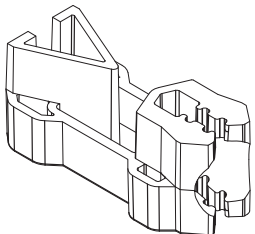
	Kit Includes: (2) Join-In-Opening Plugs (1) Easy Connect Joining Guide	Order No.
		9180207

End Plug (August 2019 - Present)

Note:

Part of Easy Connect Field Kit. Used to seal ends of Easy Connect joins.

		Order No.
		9178747

Gusset Plate (August 2019 - Present)

Note:

Used for factory prepped joins (JPR, JPL, JPLR, JPH, JPS and JPHS) only.

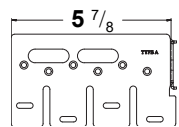
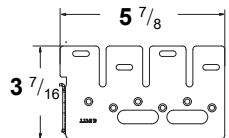
		Type	Order No.
		A	9178744
		B	9178745

Joining Components

Vintage Joining Components (2012 - July 2019)					
Vintage Window Mull Hardware Kit (2012 - July 2019)					
	Color	Order No.			
		Interior White	Interior Sandtone	Interior Dark Bronze	Interior Black
Exterior White		9130457	9130451	-	-
Exterior Terratone®		9130462	9130456	-	-
Exterior Sandtone		9130461	9130455	-	-
Exterior Cocoa Bean		9130459	9130453	-	-
Exterior Dark Bronze		9130460	9130454	9144650	-
Exterior Black		9130458	9130452	-	9144651

Interior/Exterior Trim - 96" Piece (2012 - July 2019)			
Note: Used June 2012 to July 2019. See page 42 for previous vintage in Service Replacement section (TSM approval).			
		Color	Order No.
		White	9123400
		Terratone®	9123415
		Sandtone	9123412
		Cocoa Bean	9123406
		Dark Bronze	9123409
		Black	9123403

End Cap (2012 - July 2019)			
		Color	Order No.
		White	9123306
		Terratone®	9123311
		Sandtone	9123310
		Cocoa Bean	9123308
		Dark Bronze	9123309
		Black	9123307

100 Series Single-Hung Windows (2008 to Present)

Standard and Custom Windows

Joining Components

Drip Caps

Universal Drip Cap

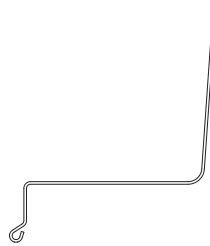

Color	72"	95 1/2"	120"	151"
	Order No.	Order No.	Order No.	Order No.
White	2222525	3884233	2222546	2222555
Terratone®	2222528	3884234	2222549	2222557
Sandtone	2222530	3884235	2222551	2222559
Cocoa Bean	9003118	9003087	9003128	9003132
Dark Bronze	9020502	9103993	9020504	9020506
Black	9003561	9125949	9003569	9003577

Universal Drip Cap / 1" Stucco Key Frame

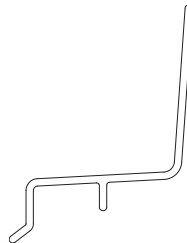

Color	72"	95 1/2"	120"	151"
	Order No.	Order No.	Order No.	Order No.
White	9130416	9130417	9130414	9130415
Terratone®	9130436	9130437	9130434	9130435
Sandtone	9130432	9130433	9130430	9130431
Cocoa Bean	N/A	N/A	N/A	9130423
Dark Bronze	9130428	9130429	9130426	9130427
Black	9130420	9130421	9130418	9130419

Notes

100 Series Single-Hung Windows (2008 to Present)

Service Replacement

Service Replacement Only Parts

Service Replacement Only Parts

Note:

This section is specifically designed for parts that should only be ordered if a TSM/SPC has requested them to be ordered or if the customer agrees to also pay for a non-warranty repair/replace service job (subject to availability) for these parts to be installed. We do not recommend anyone other than a trained AW employee or Service Provider install these parts due to the complexity of installation, modifications required for installation and/or requirement of special tools.

Weatherstrip

Weatherstrip - Tri Fin

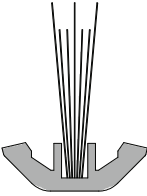
		Length	Order No.
		8'	9130399
		50'	9130398

Dust Pad / Minor - Lower Check

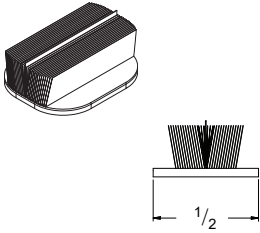
	<p>Note: Use to fill void if pile weatherstrip is separated.</p>	Dimensions (w x h)	Order No.
		1/2 x 7/32	3020332

Sash Components - Miscellaneous

Cover

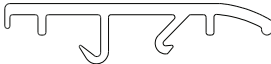
	<p>Note: Replacement sash covers are made to order.</p> <p><i>To order, state:</i></p> <ol style="list-style-type: none"> 1. Description of part (Sash cover) 2. Product ID (from product label, see Service Guide 9051877) 3. Manufactured date 4. Color 	
---	--	--

Service Replacement Only Parts

Trim Strip			
Interior/Exterior Trim with VHB Tape Applied - 96" Piece			
Note: Used through May 2012.			
		Color	Order No.
		White	9130553
		Terratone®	9130558
		Sandtone	9130557
		Cocoa Bean	9130555
		Dark Bronze	9130556

Plug			
Sash Take-out			
		Color	Order No.
		White	9043621
		Sandtone	9043620

Spacer			
Setting Block			
		Dimensions	Order No.
		1/8" x 1" x 4"	9047443
		1/8" x 7/8" x 3"	9046289
		1/16" x 7/8" x 2 1/4"	9123258

Glazing Bead			
Glazing Bead / 8'			
Note: 96" lineal length.			
		Color	Order No.
		White	9130404
		Terratone®	9130409
		Sandtone	9130408
		Cocoa Bean	9130406
		Dark Bronze	9130407
	Black	9130405	

100 Series Single-Hung Windows (2008 to Present)

Service Replacement

Service Replacement Only Parts

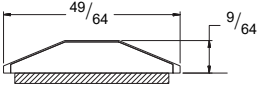
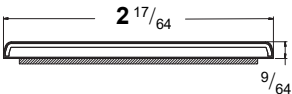
Grille / Vinyl			
Exterior/Interior Grille with tape / Vinyl / 3/4" W			
Note: 3/4" wide.			
	Color	72"	108"
	White	9178882	9173962
	Terratone®	9178884	9173964
	Sandtone	9178883	9173963
	Cocoa Bean	9178885	9173965
	Dark Bronze	9178886	9173966
Black	9178887	9173967	
Exterior/Interior Grille with tape / Vinyl / 2 1/4" W			
Note: 2 1/4" wide.			
	Color	72"	108"
	White	9178899	9173979
	Terratone®	9178894	9173974
	Sandtone	9178895	9173975
	Cocoa Bean	9178897	9173977
	Dark Bronze	9178896	9173976
Black	9178898	9173978	

817 Mull Repair	
Adhesive - Dual Pack Injector	
	Order No. 9180322
Dispensing Gun - 2 Part Adhesive Application	
	Order No. 9068754
Nozzle - Straight Tip	
	Order No. 9053806

Service Replacement Only Parts

Flush Fin Mull Components

Bent Interior Flat Trim Kits *(April 2023 - Present)*

Note:

Made to order kits for flush fin specialty shapes individual units & specialty shapes mulls. Specific unit dimensions required - use product ID label or service technician to measure correct dimensions.

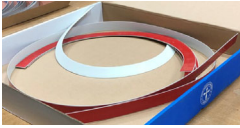
		Order No.
		Configured

End Cap - Flush Fin *(April 2023 - Present)*

Note:

Used on flush fin mull.

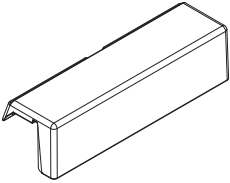
		Color	Order No.
		White	9185751
		Terratone®	9185755
		Sandtone	9185752
		Dark Bronze	9185754
		Black	9185753

End Plug - Flush Fin *(April 2023 - Present)*

Note:

Used for end sealing flush fin mull.

		Order No.
		9185756