

**What's in This Section**

<b>Double-Hung, Picture &amp; Transom Insert Windows</b> .....	<b>Page 3</b>
<b>Parts Illustration</b> .....	<b>3</b>
<b>Unit Sizes</b> .....	<b>4</b>
Custom Window Sizes .....	4
400 Series Product Label .....	4
Unit Size Chart .....	5
<b>Product History</b> .....	<b>6</b>
Milestones .....	6
<b>Complete Insert Windows</b> .....	<b>7</b>
Complete Insert Window .....	7
<b>Sash</b> .....	<b>8</b>
Sash - Upper or Lower .....	8
Weatherstrip .....	9
Sash Hardware - Lifts .....	10
Sash Hardware - Lock Kits/Components .....	12
Sash Hardware - Latch Kits .....	14
Sash Hardware - Opening Control Device .....	14
Shim Kits/Components .....	15
Sash Components - Miscellaneous .....	15
<b>Sash Balancers</b> .....	<b>16</b>
Sash Balancers .....	16
Sash Balancer Hardware .....	20
<b>Glass</b> .....	<b>21</b>
Glass - Picture and Transom Units .....	21
<b>Insect Screens</b> .....	<b>22</b>
Insect Screen - Full .....	22
Insect Screen - Half .....	23
Insect Screen Parts .....	25
<b>Grilles</b> .....	<b>26</b>
Interior Grilles .....	26
<b>Frames</b> .....	<b>27</b>
Complete Frames .....	27
Stops .....	28
Filler Kit .....	28
Weatherstrip .....	29
Frame Parts .....	30

<b>Joining Components</b> .....	<b>32</b>
Narrow Joining Parts .....	32
<b>Installation Materials</b> .....	<b>34</b>
Installation Materials .....	34
<b>Service Replacement</b> .....	<b>Page 37</b>
<b>Service Replacement Only</b> .....	<b>37</b>
Service Replacement Only Parts .....	37
Sash Interlocks .....	37
Service Materials .....	38
Exterior Grilles - HDN .....	38
Jamb Liners .....	38
Weatherstrip .....	38

# 400 Series Woodwright® Insert Windows (2005 to Present)

## Double-Hung, Picture & Transom Insert Windows

### Parts Illustration

#### Parts Illustration

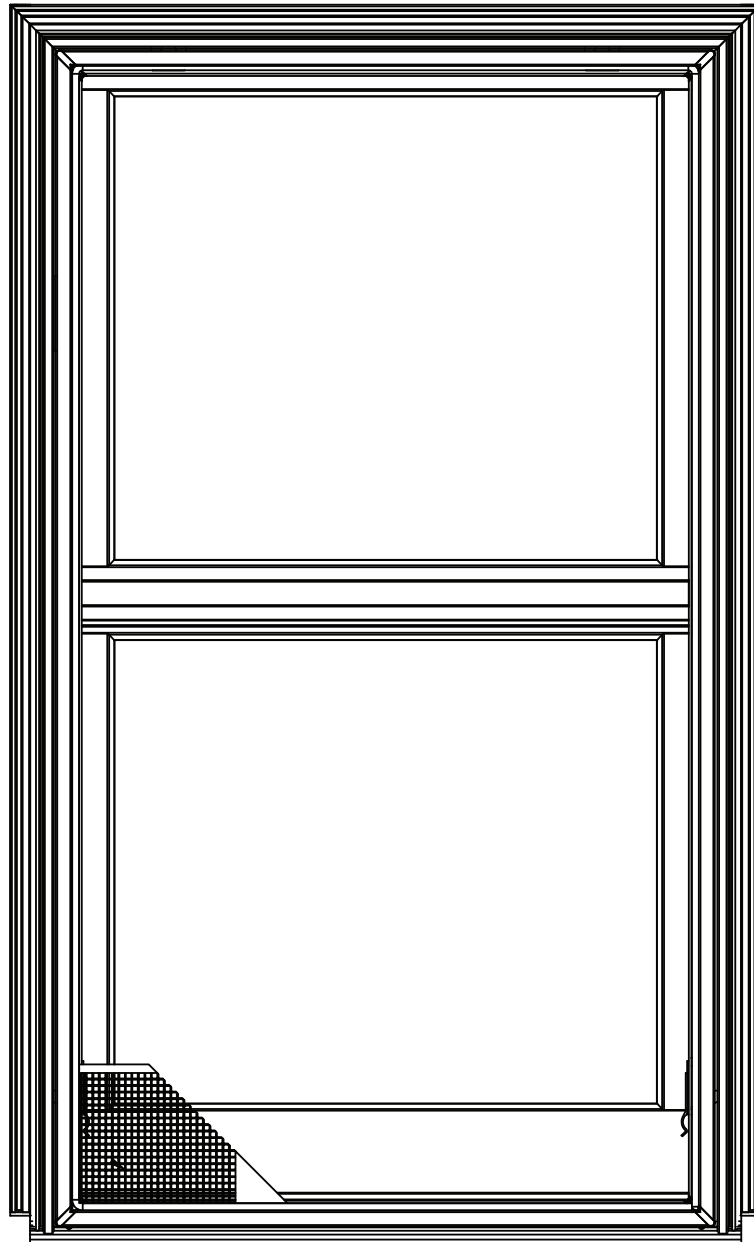

Manufactured 2005 to Present

**Woodwright® Double-Hung, Picture & Transom Insert Window Unit Parts**

*Unit viewed from exterior.*

## Unit Sizes

---

### Custom Window Sizes

**Note:**

Woodwright Insert Windows are available in custom sizes in 1/8" increments between the smallest and the largest standard sizes. Most replacement parts for custom-sized windows are made to order and can be ordered with the Product ID found on the identification label and a description of the part needed. See [Service Guide 9051877](#).

### 400 Series Product Label

**Note:**

Every Woodwright Insert Window will have an identification label **or** glass etching containing a unique Product ID. The label on a double-hung insert is located in the upper left corner of the upper sash head jamb track. The label on a picture or transom unit is located under the side stop in the lower right-hand corner or etched into the glass. See [Service Guide 9051877](#). The Product ID may be up to 14 digits long (excluding hyphens), depending on the age of the unit. Replacement parts will also get their own unique Product ID. When ordering replacement parts, providing the Product ID ensures that replacement parts match the specifications.

# 400 Series Woodwright® Insert Windows (2005 to Present)

Double-Hung, Picture & Transom Insert Windows

## Unit Sizes

### Unit Size Chart

#### Woodwright® Double-Hung Insert Window Size Range

##### EQUAL SASH UNIT SIZES

Unit height limits depend on new insert unit sill angle.

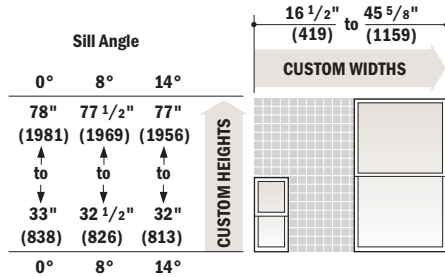

##### COTTAGE OR REVERSE COTTAGE SASH UNIT SIZES

Unit height limits depend on new insert unit sill angle.

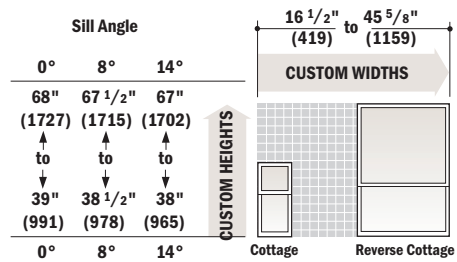

##### PICTURE UNIT SIZES

Picture window height limits depend on new insert unit sill angle.

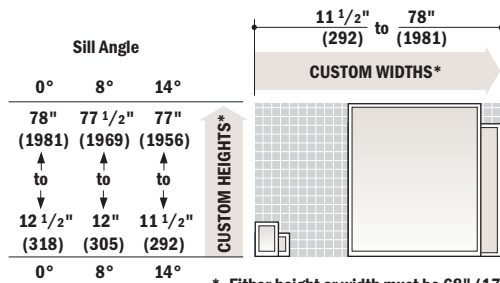

\* Either height or width must be 68" (1727) or less. Height plus width cannot be less than 28" (711).

##### TRANSOM UNIT SIZES

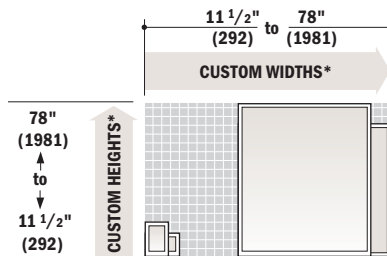

\* Either height or width must be 68" (1727) or less. Height plus width cannot be less than 28" (711).

- Dimensions in parentheses are in millimeters.
- When ordering, be sure to specify color desired: White, Sandtone, Terratone® or Forest Green.

### Woodwright® Double-Hung, Picture & Transom Insert Window Unit Sizes

## Product History

---

### Milestones

- 2017** Lock/Keeper and Tilt-Latch redesign in March 2017.
- 2008** SmartSun™ glass introduced.
- 2005** Woodwright® Insert Windows introduced.

# 400 Series Woodwright® Insert Windows (2005 to Present)

Double-Hung, Picture & Transom Insert Windows

## Complete Insert Windows

### Complete Insert Window

**Note:**

See latest [Product Details](#).

### Complete Insert Window

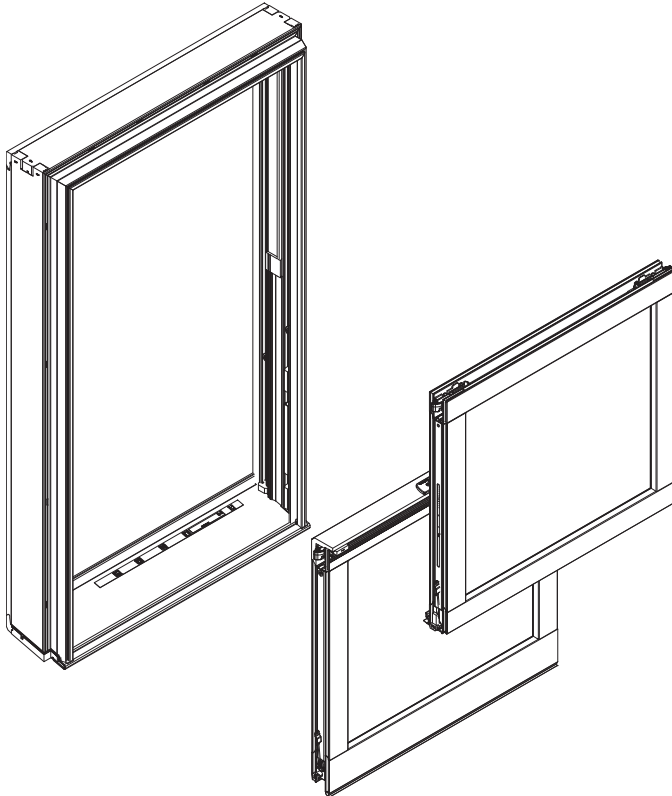

**Note:**

All Woodwright® insert windows are made to order.

Perma-Shield Narroline and Primed Narroline windows one-step and two-step sills are at a 14° angle.

**Exterior color options:**

White, Terratone®, Sandtone, Forest Green, Canvas, Dark Bronze, Black

**Interior finish options:**

Pine, Maple, Oak, or Prefinished White

**Glass options:**

Low-E4®, Low-E4® SmartSun™, Low-E4® Sun, Low-E4® Tempered, Low-E4® SmartSun™ Tempered, Low-E4® Sun™ Tempered and additional special glazings

**Factory applied grille options:**

Finelight™ grilles-between-the-glass  
High-definition grilles - Full divided light with spacer  
Simulated divided light without spacer  
Exterior grilles

*To order, state:*

1. **Description of Part (Complete Insert)**
2. **Quantity**
3. **Product ID (from product label, see [Service Guide 9051877](#))**
4. **Options Desired**

## Sash

### Sash - Upper or Lower

#### Sash - Upper or Lower

**Note:**  
See latest [Product Details](#).

Upper Sash

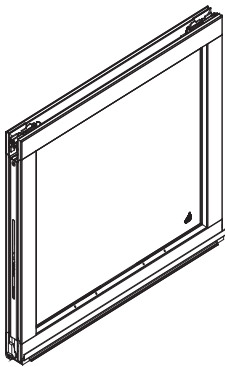

Lower Sash

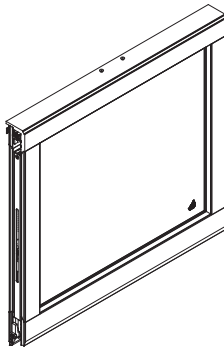

Glass Logo

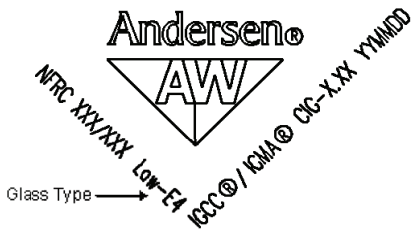

Tempered Logo

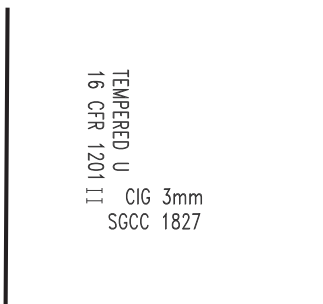

**Note:**  
Replacement sash is made to order. Sash comes with balancers, lock, and tilt latches. Upper and lower replacement sashes can be ordered separately. New design for lock/keeper and tilt-latch introduced in March 2017.

**Exterior color options:**

White	Terratone®	Sandtone
Forest Green	Canvas	Dark Bronze
Black		

**Interior finish options:**

Pine	Maple	Oak
Prefinished White		

**Glass options (See Logo example):**

High-Performance Low-E4®	High-Performance Low-E4® SmartSun™	High-Performance Low-E4® Sun
High Performance Low-E4® Tempered	High-Performance Low-E4® SmartSun™ Tempered	High-Performance Low-E4® Sun Tempered

**Factory applied grille options:**

- Finelight™ grilles-between-the-glass
- High-definition grilles - Full divided light with spacer
- Simulated divided light without spacer
- Exterior grilles

To order, state:

1. Description of Part (upper or lower sash)
2. Quantity
3. Product ID (from product label, see [Service Guide 9051877](#))
4. Options Desired (if different than original product)



# 400 Series Woodwright® Insert Windows (2005 to Present)

Double-Hung, Picture & Transom Insert Windows

## Sash

### Weatherstrip

#### Weatherstrip - Interlock *(December 2007 to present)*

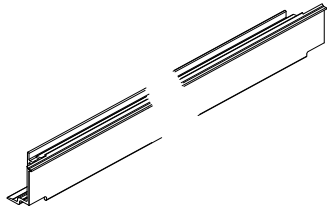

Upper Interlock

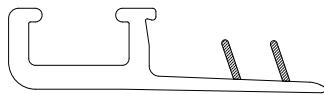

Lower Interlock

**Note:**

Upper and lower interlock weatherstrip for standard and custom size windows are made to order. Cut to length. Also order felt spacer and screws for lower interlock. Lineal lengths are available for service replacement ([see page 35](#)).

To order, state:

1. Description of Part (Upper or Lower Weatherstrip Interlock)
2. Quantity
3. Product ID (from product label, see [Service Guide 9051877](#))

#### Screw - Lower Interlock

	Description	Order No.
	PH pan 8 - 15 x 3/8 #5 302 SS	0102714

#### Weatherstrip - Bottom Rail

**Note:**

See [Service Guide 0005402](#).

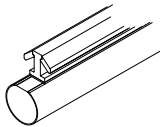

	Length	Order No.
	10 ft.	0102606

## Sash

### Sash Hardware - Lifts

#### Lift w/Screws - Classic

**Note:**

See [Accessory Guide 0005180](#). Bar lift and hand lift quantity of one, finger lift quantity of two.

	<p style="text-align: center;"><b>3 3/8</b></p>	<p style="text-align: center;"><b>3 19/64</b></p>	<p style="text-align: center;"><b>1 13/64</b></p>
	<b>Bar</b>	<b>Hand</b>	<b>Finger</b>
<b>Color</b>	<b>Order No.</b>	<b>Order No.</b>	<b>Order No.</b>
White	1630025	1643002	1643004
Stone	1630027	1643001	1643003

#### Lift w/Screws - Traditional (8/2017 - Present)

**Note:**

For units manufactured from 1992 to July 2017 see Traditional style lifts in [A-Series Double-Hung](#) section.

Hand lift quantity of one, finger lift quantity of two. See [Accessory Guide 9166501](#). See [Accessory Guide 9159962](#).

	<p style="text-align: center;"><b>4 7/16</b></p>	<p style="text-align: center;"><b>2 1/2</b></p>	<p style="text-align: center;"><b>1 1/4</b></p>
	<b>Bar</b>	<b>Hand</b>	<b>Finger</b>
<b>Color</b>	<b>Order No.</b>	<b>Order No.</b>	<b>Order No.</b>
White	9159470	9159482	9159494
Stone	9159471	9159483	9159495
Gold Dust	9159468	9159480	9159492
Black	9159469	9159481	9159493
Bright Brass	9159461	9159473	9159485
Satin Nickel	9159465	9159476	9159489
Oil-Rubbed Bronze	9159463	9159475	9159487
Antique Brass	9159460	9159472	9159484
Brushed Chrome	9159462	9159474	9159486
Polished Chrome	9159464	9159477	9159488
Distressed Bronze	9159466	9159478	9159490
Distressed Nickel	9159467	9159479	9159491

# 400 Series Woodwright® Insert Windows (2005 to Present)

Double-Hung, Picture & Transom Insert Windows

## Sash

### Lift w/Screws - Estate

**Note:**

See [Accessory Guide 0005180](#). Bar lift and hand lift quantity of one, finger lift quantity of two.

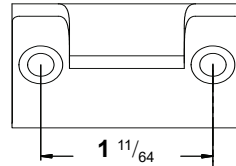
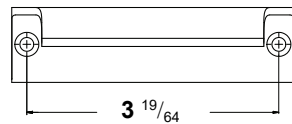

**Hand**

**Finger**

**Color**

**Order No.**

**Order No.**

Antique Brass	1600694	1600693
Bright Brass	1643043	1643040
Chrome	1643045	1643042
Brushed Chrome	1600404	1600402
Satin Nickel	1642922	1642920
Oil Rubbed Bronze	1642921	1642919
Distressed Bronze	1642932	1642931
Distressed Nickel	1600405	1600403

### Lift w/Screws - Contemporary (August 2017 - Present)

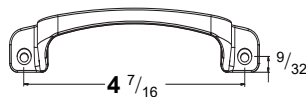

**Bar**

**Color**

**Order No.**

White	9160290
Stone	9160291
Gold Dust	9160288
Black	9160289
Bright Brass	9160281
Satin Nickel	9160285
Oil-Rubbed Bronze	9160283
Antique Brass	9160280
Brushed Chrome	9160282
Polished Chrome	9160284
Distressed Bronze	9160286
Distressed Nickel	9160287

## Sash

### Sash Hardware - Lock Kits/Components

#### Lock/Keeper Kit (March 2017 to Present)

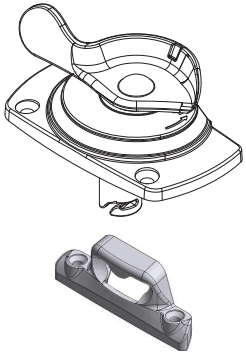
	<b>Kit includes:</b> (1) Lock (Active lock shown) (1) Keeper (4) Screws See <a href="#">Accessory Guide 9166409</a>	<b>Finish</b>	<b>Active</b>	<b>Passive</b>
		Bright Brass	9159918	9159930
		Antique Brass	9159914	9159926
		Brushed Chrome	9159920	9159932
		Polished Chrome	9159922	9159934
		Oil Rubbed Bronze	9159916	9159928
		Satin Nickel	9159923	9159935
		Distressed Bronze	9159915	9159927
		Distressed Nickel	9159921	9159933
		Black	9159917	9159929
		Gold Dust	9159919	9159931
		Stone	9159924	9159936
		White	9159925	9159937

#### Lock Set - Estate (2005 to March 2017)

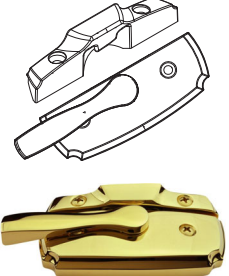
	<b>Set includes:</b> (1) Lock (1) Keeper (4) Screws See <a href="#">Accessory Guide 0005256</a> .	<b>Finish</b>	<b>Order No.</b>
		Bright Brass	0102628
		Antique Brass	0102630
		Brushed Chrome	0102629
		Polished Chrome	0102632
		Oil Rubbed Bronze	0102631
		Satin Nickel	0102633
		Distressed Bronze	0102621
		Distressed Nickel	0102622

#### Lock (2005 to March 2017)

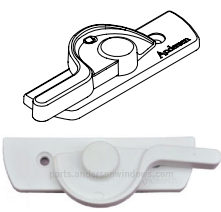
	<b>Note:</b> Ships with screws.	<b>Finish</b>	<b>Order No.</b>
		Stone	0102006
		White	0102005

#### Keeper (2005 to March 2017)

	<b>Note:</b> Ships with screws.	<b>Finish</b>	<b>Order No.</b>
		Stone	0102015
		White	0102014

## 400 Series Woodwright® Insert Windows (2005 to Present)

*Double-Hung, Picture & Transom Insert Windows*

### Sash

Screw - Lock and Keeper		
	Finish	Order No.
	White	0102003
	Stone	0102004

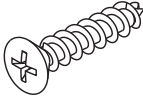
Screw - Lock and Keeper			
	Description:	Color	Order No.
	6-10 x 3/4" PLS Z PH SP oval STL ZD	Stone	3620225
		White	3620226
		Gold Dust	9004465
		Black	9004466
		Bright Brass	9004467
		Satin Nickel	9004468
		Oil-Rubbed Bronze	9004469
		Antique Brass	9004470
		Brushed Chrome	9004471
		Polished Chrome	9004472

## Sash

### Sash Hardware - Latch Kits

#### Tilt Latch Kit (March 2017 to Present)

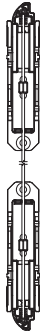
	<b>Kit includes:</b> (2) Tilt Latches - upper (1) Latch Assembly - lower (1) Crimp Pin (4) Screws <a href="#">Service Guide 9166408</a>	<b>Order No.</b>
		9159913

### Sash Hardware - Opening Control Device

#### Opening Control Device Kit

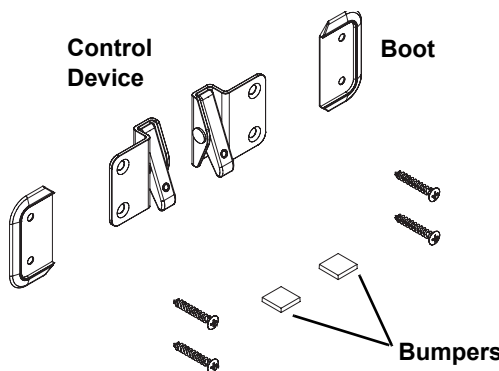
		
---	--	--

<b>Kit includes:</b> (2) Opening control devices (2) Boots (4) Screws (2) Bumpers See <a href="#">Accessory Guide 9021977</a>		
--	--	--

	<b>Finish</b>	<b>Order No.</b>
	Stone	9021976
	White	9021975

#### Screw Pack - Opening Control Device Kit

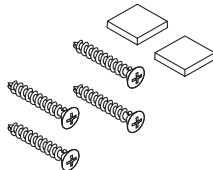
	<b>Kit includes:</b> (4) Screws (2) Bumpers	<b>Color</b>	<b>Order No.</b>
		Stone	9031536
		White	9031535



# 400 Series Woodwright® Insert Windows (2005 to Present)

Double-Hung, Picture & Transom Insert Windows

## Sash

### Shim Kits/Components

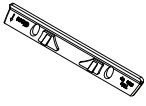
#### Shim Kits

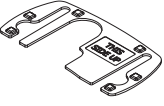
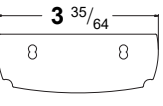
						
					<b>Estate</b>	
<b>Color</b>	<b>Keeper</b>	<b>Lock</b>	<b>Keeper</b>	<b>Lock</b>	<b>Lock</b>	
White	0100083	0100082	9159952	9159955	9173745	
Stone	0100085	0100084	9159953	9159956	9173746	
Black	-	-	9159954	9159957	-	
Gold Dust	-	-	-	-	-	

### Sash Components - Miscellaneous

#### Screw - Check Rail Packaging Clip

	Description	Color	Order No.
	#8 - 10 x 1 3/16"	Stone	0873242
	<b>Note:</b> Use screw to replace packaging clip on check rail.	White	0873241

### Tilt-Latch and Wash Assist Kit

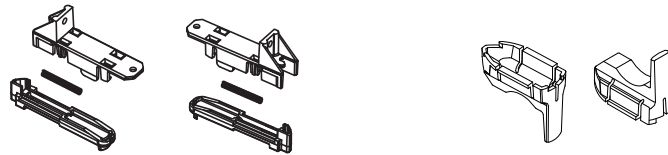

Tilt-Latches

Wash Assists

	Finish	Order No.
	White	0102091
	Gray	0102092

Latch Screw	Order No.
	0102011

## Sash Balancers

### Sash Balancers

#### Sash Balancers

**Note:**

The balancer number is imprinted onto the side of each balancer. Refer to the charts below to find the order number. See [Service Guide 0005435](#).

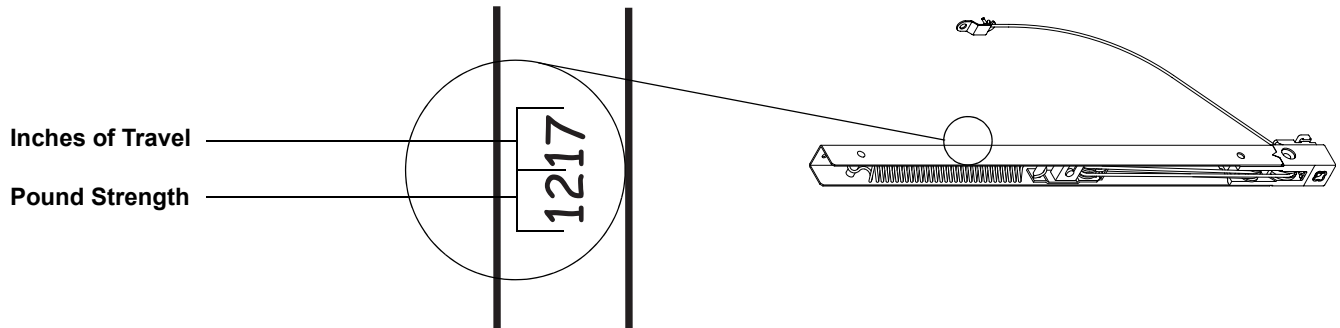

**Woodwright® Insert Double-Hung Sash Balancer**

#### Sash Balancers (3 lbs. - 8 lbs.)

Balancer No.	Order No.	Balancer No.	Order No.	Balancer No.	Order No.	Balancer No.	Order No.
311	0102782	524	0102812	717	0102843	819	0102872
312	0102783	526	0102813	718	0102844	820	0102873
313	0102784	613	0102817	719	0102845	821	0102874
314	0102785	614	0102818	720	0102846	822	0102875
315	0102786	615	0102819	721	0102847	823	0102876
412	0102789	616	0102820	722	0102848	824	0102877
413	0102790	617	0102821	723	0102849	825	0102878
414	0102791	618	0102822	724	0102850	826	0102879
415	0102792	619	0102823	725	0102851	827	0102880
416	0102793	620	0102824	726	0102852	828	0102881
417	0102794	621	0102825	727	0102853	829	0102882
418	0102795	622	0102826	728	0102854	830	0102883
419	0102796	623	0102827	729	0102855	831	0102884
420	0102797	624	0102828	730	0102856	832	0102885
513	0102801	625	0102829	731	0102857	833	0102886
514	0102802	626	0102830	732	0102858	834	0102887
515	0102803	627	0102831	733	0102859	835	0102888
516	0102804	628	0102832	734	0102860	836	0102889
517	0102805	629	0102833	735	0102861	837	0102890
518	0102806	630	0102834	736	0102862	838	0102891
519	0102807	631	0102835	812	0102865	839	0102892
520	0102808	712	0102838	815	0102868	840	0102893
521	0102809	714	0102840	816	0102869	841	0102894
522	0102810	715	0102841	817	0102870		
523	0102811	716	0102842	818	0102871		



## 400 Series Woodwright® Insert Windows (2005 to Present)

*Double-Hung, Picture & Transom Insert Windows*

### Sash Balancers

<b>Sash Balancers (9 lbs. - 13 lbs.)</b>							
<b>Balancer No.</b>	<b>Order No.</b>	<b>Balancer No.</b>	<b>Order No.</b>	<b>Balancer No.</b>	<b>Order No.</b>	<b>Balancer No.</b>	<b>Order No.</b>
912	0102897	1023	0102945	1131	0102988	1242	0103034
915	0102901	1024	0102946	1132	0102989	1243	0103035
916	0102902	1025	0102947	1133	0102990	1244	0103036
917	0102903	1026	0102948	1134	0102991	1245	0103037
918	0102904	1027	0102949	1135	0102992	1318	0103042
919	0102905	1028	0102950	1136	0102993	1319	0103043
920	0102906	1029	0102951	1137	0102994	1320	0103044
921	0102907	1030	0102952	1138	0102995	1321	0103045
922	0102908	1031	0102953	1139	0102996	1322	0103046
923	0102909	1032	0102954	1140	0102997	1323	0103047
924	0102910	1033	0102955	1141	0102998	1324	0103048
925	0102911	1034	0102956	1142	0102999	1325	0103049
926	0102912	1035	0102957	1143	0103001	1326	0103050
927	0102913	1036	0102958	1144	0103002	1327	0103051
928	0102914	1037	0102959	1145	0103003	1328	0103052
929	0102915	1038	0102960	1214	0103006	1329	0103053
930	0102916	1039	0102961	1217	0103009	1330	0103054
931	0102917	1040	0102962	1218	0103010	1331	0103055
932	0102918	1041	0102963	1219	0103011	1332	0103056
933	0102919	1042	0102964	1220	0103012	1333	0103057
934	0102920	1043	0102965	1221	0103013	1334	0103058
935	0102921	1044	0102966	1222	0103014	1335	0103059
936	0102922	1045	0102967	1223	0103015	1336	0103060
937	0102923	1112	0102969	1224	0103016	1337	0103061
938	0102924	1113	0102970	1225	0103017	1338	0103062
939	0102925	1114	0102971	1226	0103018	1339	0103063
940	0102926	1116	0102973	1227	0103019	1340	0103064
941	0102927	1117	0102974	1228	0103020	1341	0103065
942	0102928	1118	0102975	1229	0103021	1342	0103066
943	0102929	1119	0102976	1230	0103022	1343	0103067
944	0102930	1120	0102977	1231	0103023	1344	0103068
945	0102931	1121	0102978	1232	0103024	1345	0103069
1012	0102934	1122	0102979	1233	0103025		
1013	0102935	1123	0102980	1234	0103026		
1016	0102938	1124	0102981	1235	0103027		
1017	0102939	1125	0102982	1236	0103028		
1018	0102940	1126	0102983	1237	0103029		
1019	0102941	1127	0102984	1238	0103030		
1020	0102942	1128	0102985	1239	0103031		
1021	0102943	1129	0102986	1240	0103032		
1022	0102944	1130	0102987	1241	0103033		

## Sash Balancers

<b>Sash Balancers (14 lbs. - 19 lbs.)</b>							
<b>Balancer No.</b>	<b>Order No.</b>	<b>Balancer No.</b>	<b>Order No.</b>	<b>Balancer No.</b>	<b>Order No.</b>	<b>Balancer No.</b>	<b>Order No.</b>
1420	0103074	1532	0103116	1722	0103162	1839	0103205
1421	0103075	1533	0103117	1723	0103163	1840	0103206
1422	0103076	1534	0103118	1724	0103164	1841	0103207
1423	0103077	1535	0103119	1725	0103165	1842	0103208
1424	0103078	1536	0103120	1726	0103166	1843	0103209
1425	0103079	1537	0103121	1727	0103167	1844	0103210
1426	0103080	1538	0103122	1728	0103168	1845	0103211
1427	0103081	1539	0103123	1729	0103169	1925	0103215
1428	0103082	1540	0103124	1730	0103170	1926	0103216
1429	0103083	1541	0103125	1731	0103171	1927	0103217
1430	0103084	1542	0103126	1732	0103172	1928	0103218
1431	0103085	1543	0103127	1733	0103173	1929	0103219
1432	0103086	1544	0103128	1734	0103174	1930	0103220
1433	0103087	1545	0103129	1735	0103175	1931	0103221
1434	0103088	1622	0103135	1736	0103176	1932	0103222
1435	0103089	1623	0103136	1737	0103177	1933	0103223
1436	0103090	1624	0103137	1738	0103178	1934	0103224
1437	0103091	1625	0103138	1739	0103179	1935	0103225
1438	0103092	1626	0103139	1740	0103180	1936	0103226
1439	0103093	1627	0103140	1741	0103181	1937	0103227
1440	0103094	1628	0103141	1742	0103182	1938	0103228
1441	0103095	1629	0103142	1743	0103183	1939	0103229
1442	0103096	1630	0103143	1744	0103184	1940	0103231
1443	0103097	1631	0103144	1745	0103185	1941	0103232
1444	0103098	1632	0103145	1825	0103190	1942	0103233
1445	0103099	1633	0103146	1826	0103191	1943	0103234
1520	0103104	1634	0103147	1827	0103192	1945	0103235
1527	0103111	1641	0103154	1834	0103199		
1528	0103112	1642	0103155	1835	0103201		
1529	0103113	1643	0103156	1836	0103202		
1530	0103114	1644	0103157	1837	0103203		
1531	0103115	1645	0103158	1838	0103204		





## 400 Series Woodwright® Insert Windows (2005 to Present)

Double-Hung, Picture & Transom Insert Windows

### Sash Balancers

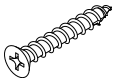
<b>Sash Balancers (20 lbs. - 23 lbs.)</b>							
<b>Balancer No.</b>	<b>Order No.</b>	<b>Balancer No.</b>	<b>Order No.</b>	<b>Balancer No.</b>	<b>Order No.</b>	<b>Balancer No.</b>	<b>Order No.</b>
<b>2024</b>	0103236	<b>2036</b>	0103248	<b>2133</b>	0103264	<b>2142</b>	0103273
<b>2025</b>	0103237	<b>2037</b>	0103249	<b>2134</b>	0103265	<b>2143</b>	0103274
<b>2026</b>	0103238	<b>2038</b>	0103250	<b>2135</b>	0103266	<b>2144</b>	0103275
<b>2027</b>	0103239	<b>2039</b>	0103251	<b>2136</b>	0103267	<b>2243</b>	0103292
<b>2028</b>	0103240	<b>2040</b>	0103252	<b>2137</b>	0103268	<b>2244</b>	0103293
<b>2029</b>	0103241	<b>2041</b>	0103253	<b>2138</b>	0103269	<b>2245</b>	0103294
<b>2033</b>	0103245	<b>2042</b>	0103254	<b>2139</b>	0103270	<b>2335</b>	0103302
<b>2034</b>	0103246	<b>2043</b>	0103255	<b>2140</b>	0103271		
<b>2035</b>	0103247	<b>2044</b>	0103256	<b>2141</b>	0103272		

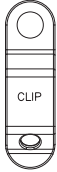
## Sash Balancers

Sash Balancer Hardware		
<b>Screw - Balance Hole / Bottom</b>		
	Description	Order No.
	8 - 18 x 2 PH #6 pan HD YMZC T-17 T/C	0102625
<b>Screw - Balance Hole / Top</b>		
	Description	Order No.
	8 - 10 x 1-3/16 PH flat HD plask #2 w/shank slot	0102624
<b>Screw - Shoulder</b>		
	Description	Package of 2
	#8 x 5/8"	0112045
<b>Balancer Clip (May 2009 to Present)</b>		
	Note:	Order No.
	Balance cord clip attaches to side jamb. Replaces previous vintages.	9019790
<b>Screw - Balancer Clip (May 2009 to Present)</b>		
	Description	Order No.
	8 - 15 x 5/8 Cross Recess #6 Truss HD Type 17 <b>Note:</b> Used to secure balance cord clip to side jamb.	1521125
<b>Screw - Balancer Clip (December 2007 to April 2009)</b>		
	Description	Order No.
	8 - 15 x 5/8 #10 pan HD type 17 <b>Note:</b> Used to secure balance cord clip to side jamb.	9000915

# 400 Series Woodwright® Insert Windows (2005 to Present)

Double-Hung, Picture & Transom Insert Windows

## Glass

### Glass - Picture and Transom Units

#### Glass - Picture and Transom Units

**Note:**

Picture and transom window glass is made to order.

*To order, state:*

1. **Description of part (picture or transom window glass)**
2. **Quantity**
3. **Product ID (from product label, see [Service Guide 9051877](#))**

## Insect Screens

### Insect Screen - Full

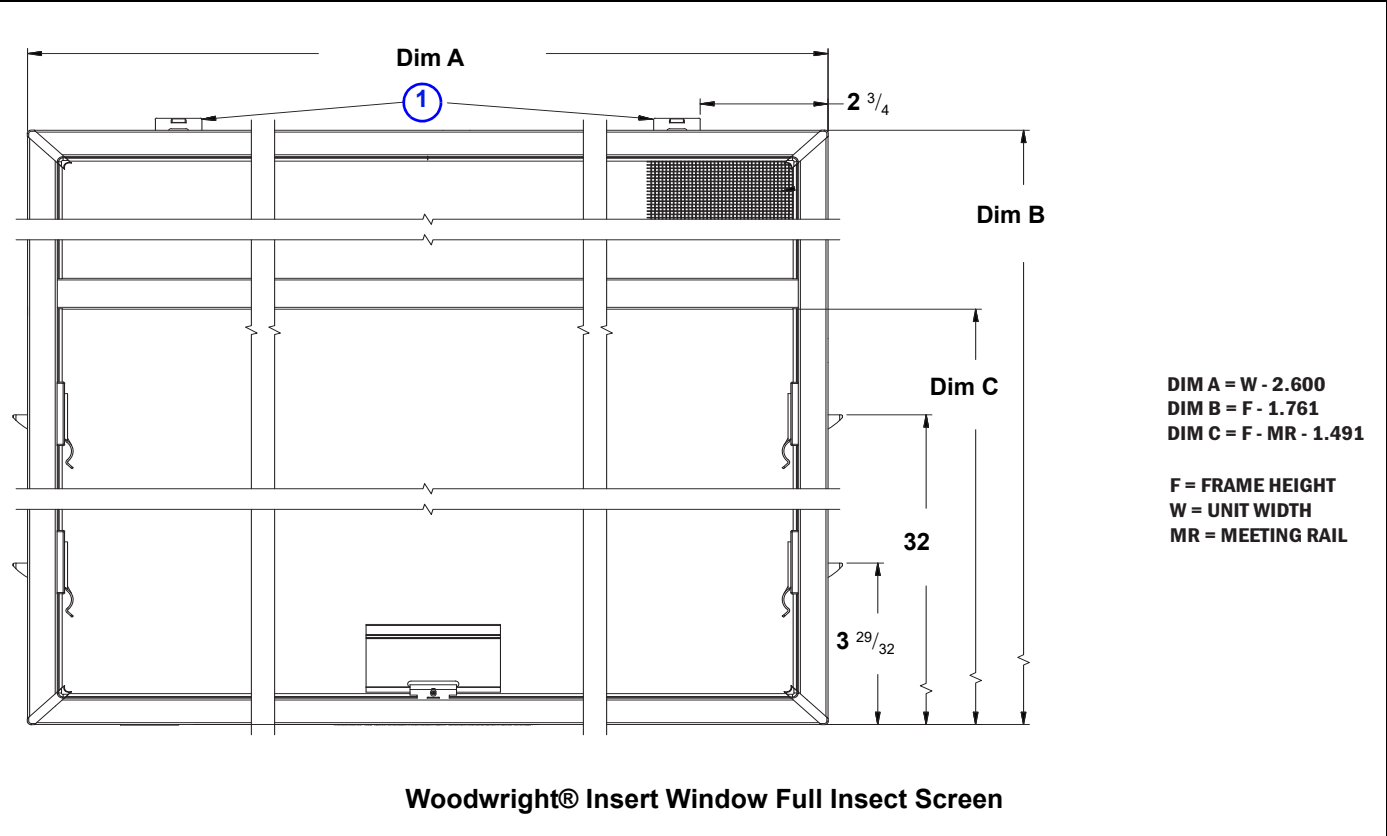

### Insect Screen - Full / TruScene®

**Note:**

Full window insect screens with TruScene® screens are made to order. Second set of latches required only when screen height is greater than 69.844", unless center bar location dimension is less than 34.550".

To order, state:

1. Description of Part (full insect screen with TruScene® screen)
2. Quantity
3. Product ID (from product label, see [Service Guide 9051877](#))

### Insect Screen - Full / Standard

**Note:**

Full window insect screens with standard screens are made to order. Second set of latches required only when screen height is greater than 69.844", unless center bar location dimension is less than 34.550".

To order, state:

1. Description of Part (full insect screen with standard screen)
2. Quantity
3. Product ID (from product label, see [Service Guide 9051877](#))

## 400 Series Woodwright® Insert Windows (2005 to Present)

Double-Hung, Picture & Transom Insert Windows

### Insect Screens

#### Insect Screen - Half

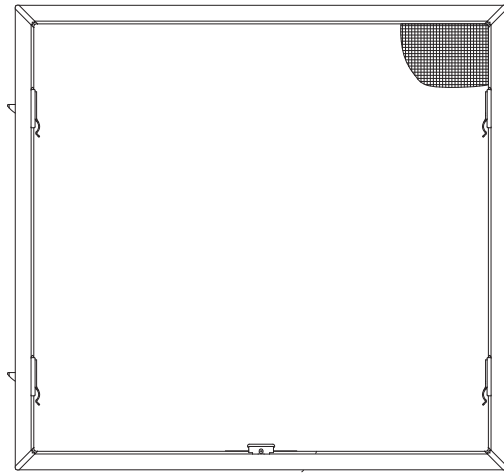

Woodwright® Insert Window Half Insect Screen

#### Insect Screen - Half / TruScene®

**Note:**

TruScene® half insect screen replacements are made to order.

*To order, state:*

1. Description of Part (TruScene® half screen)
2. Quantity
3. Product ID (from product label, see [Service Guide 9051877](#))

#### Insect Screen - Half / Standard

**Note:**

Standard half insect screen replacements are made to order.

*To order, state:*

1. Description of Part (standard half screen)
2. Quantity
3. Product ID (from product label, see [Service Guide 9051877](#))

## Insect Screens

### Insect Screen Parts

Screen Lock with Housing (Pair)			
	<p><b>Note:</b> Complete screen replacement is recommended if this component part is damaged</p>	Color	Order No.
		White	1693417
		Terratone®	2791264
		Sandtone	1191313
		Forest Green	0381364

Bug Seal		
	<p><b>Note:</b> Order by the foot. Replacement weatherstrip/bug seal is adhesive backed.</p>	Order No.
		8261001

Screen Clip - Top Rail Ref. No. 1 <a href="#">page 22</a>		
	<p><b>Note:</b> Use with full screen.</p>	Order No.
		9069417

Finger Pull - Insect Screen / Full		
		Order No.
		8121701

Screen Label with Clip		
		Order No.
		1631110



# 400 Series Woodwright® Insert Windows (2005 to Present)

Double-Hung, Picture & Transom Insert Windows

## Grilles

### Interior Grilles

**Note:**

Grilles include fasteners. Replacement finelight grilles, high-definition grilles, and exterior grilles are available as part of a replacement sash only. To order, see upper or lower sash, [page 8](#).

### Interior Grilles - Removable

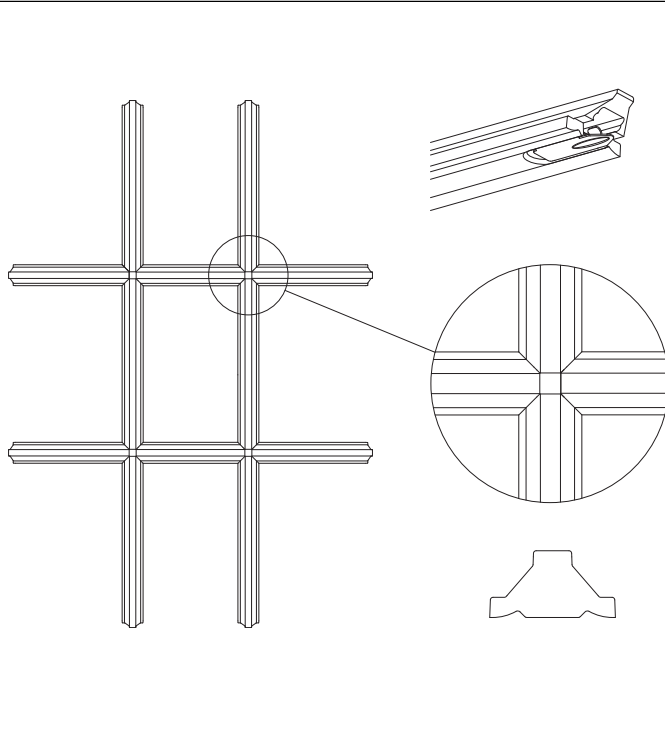

**Note:**

Removable interior grilles are made to order.

To order, state:

1. Description of Part (removable interior grilles)
2. Quantity
3. Product ID (from product label, see [Service Guide 9051877](#))

### Interior Grille Clips

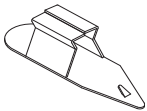

**Note:**

Secures to sash. Quantity of one clip.

Finish	Order No.
White	0174951
Terratone®	0174952
Sandtone	0174953
Forest Green	0174955
Canvas	0174954
Dark Bronze	9020288
Black	9010539

## Frames

### Complete Frames

**Note:**

See latest [Product Details](#).

### Complete Frames

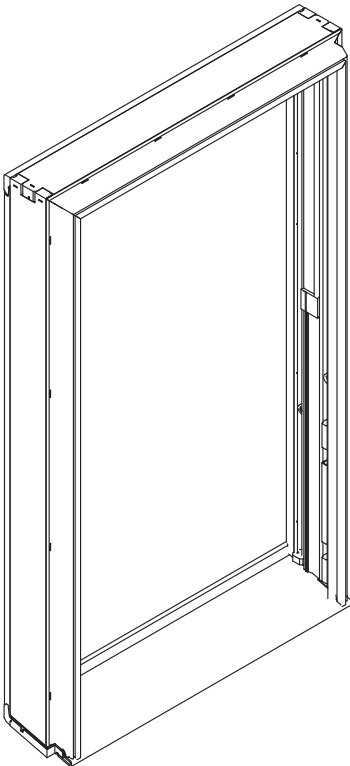

**Note:**

Complete frames for double-hung, picture, and transom insert windows are made to order. Double Hung frame shown.

*To order, state:*

1. **Description of Part (complete frame)**
2. **Quantity**
3. **Product ID (from product label, see [Service Guide 9051877](#))**

### Jamb Liner - Side

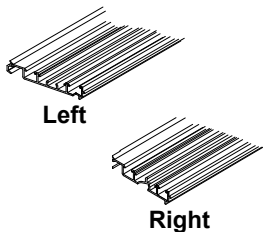

**Note:**

Side jamb liners are made to order.

**Kit includes:**

Left and right hand liners and components.

*To order, state:*

1. **Description of Part (side jamb liner)**
2. **Quantity**
3. **Product ID (from product label, see [Service Guide 9051877](#))**

# 400 Series Woodwright® Insert Windows (2005 to Present)

Double-Hung, Picture & Transom Insert Windows

## Frames

### Stops

#### Inside Stop Kit - Double-Hung Units

	<p><b>Note:</b> Inside stops are made to order. Available in kit only.</p> <p><b>Kit includes:</b> Head, sill, right hand, and left hand side stops.</p> <p><i>To order, state:</i></p> <ol style="list-style-type: none"> <li><b>Description of Part (inside stop kit)</b></li> <li><b>Quantity</b></li> <li><b>Product ID (from product label, see <a href="#">Service Guide 9051877</a>)</b></li> </ol>
--	--

#### Glass Stop Kit - Picture and Transom Units / Side

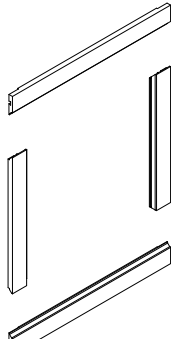
	<p><b>Note:</b> Side glass stops are made to order. Available in kit only.</p> <p><b>Kit includes:</b> Head, sill, right hand and left hand glass stops. Does not include glass clips for stop attachment.</p> <p><i>To order state:</i></p> <ol style="list-style-type: none"> <li><b>Description of Part (side glass stop kit)</b></li> <li><b>Quantity</b></li> <li><b>Product ID (from product label, see <a href="#">Service Guide 9051877</a>)</b></li> </ol>
--	---

#### Inside Stop Kit - Picture and Transom Units

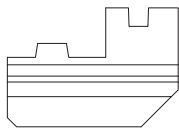
	<p><b>Note:</b> Inside stops are made to order. Available in kit only.</p> <p><b>Kit includes:</b> Head, sill, right hand, and left hand side stops.</p> <p><i>To order, state:</i></p> <ol style="list-style-type: none"> <li><b>Description of Part (inside stop kit)</b></li> <li><b>Quantity</b></li> <li><b>Product ID (from product label, see <a href="#">Service Guide 9051877</a>)</b></li> </ol>
---	--

### Filler Kit

#### Filler Kit - Picture and Transom Units / Head and Sill

	<p><b>Note:</b> Filler kits are made to order.</p> <p><b>Kit includes:</b> Head, sill, right-hand and left-hand fillers.</p> <p><i>To order state:</i></p> <ol style="list-style-type: none"> <li><b>Description of Part (head and sill filler kit)</b></li> <li><b>Quantity</b></li> <li><b>Product ID (from product label, see <a href="#">Service Guide 9051877</a>)</b></li> </ol>	<b>Length</b>	<b>Finish</b>	<b>Order No.</b>
		75	Pine	0102712
			Maple	0102724
			Oak	0102723
			Prefinished White	0102722



## Frames

Weatherstrip							
Weatherstrip - Upper/Lower Side Jamb							
	<p><b>Note:</b> Upper/Lower side jamb weatherstrip for standard and custom size windows are made to order. Upper weatherstrip has no felt weatherstrip; lower weatherstrip has felt weatherstrip applied (after 11/06). Order one pair (LH and RH).</p> <p><i>To order, state:</i></p> <ol style="list-style-type: none"> <li><b>Description of Part (Upper/Lower side jamb weatherstrip)</b></li> <li><b>Species/Finish (Pine, Oak, Maple, White)</b></li> <li><b>Quantity (Pair)</b></li> <li><b>Product ID (from product label, see <a href="#">Service Guide 9051877</a>)</b></li> </ol>						
Weatherstrip - Fin-Pile							
	<p><b>Note;</b> Used on lower side jamb assembly.</p>	<table border="1"> <thead> <tr> <th>Length</th> <th>Order No.</th> </tr> </thead> <tbody> <tr> <td>Order by the foot</td> <td>9056123</td> </tr> </tbody> </table>	Length	Order No.	Order by the foot	9056123	
Length	Order No.						
Order by the foot	9056123						
Weatherstrip - Bottom Rail / Solid							
		<table border="1"> <thead> <tr> <th>Length</th> <th>Order No.</th> </tr> </thead> <tbody> <tr> <td>10 ft.</td> <td>0102612</td> </tr> </tbody> </table>	Length	Order No.	10 ft.	0102612	
Length	Order No.						
10 ft.	0102612						
Weatherstrip - Dust Plug							
		<table border="1"> <thead> <tr> <th>Order No.</th> </tr> </thead> <tbody> <tr> <td>0102623</td> </tr> </tbody> </table>	Order No.	0102623			
Order No.							
0102623							
Liner Plug - Side / Sill							
		<table border="1"> <thead> <tr> <th>Order No.</th> </tr> </thead> <tbody> <tr> <td>0102708</td> </tr> </tbody> </table>	Order No.	0102708			
Order No.							
0102708							

# 400 Series Woodwright® Insert Windows (2005 to Present)

Double-Hung, Picture & Transom Insert Windows

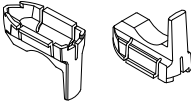
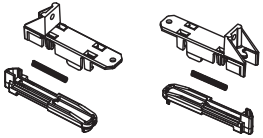
## Frames

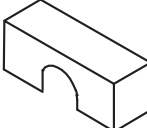
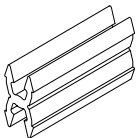
Frame Parts			
<b>Tilt-Latch and Wash Assist Kit</b> (2005 to March 2017)			
<b>Note:</b> See <a href="#">Replacement Video</a> . Tilt-latches secure to sash and wash assists secure to jamb liner.			
 <b>Wash Assists</b>	<b>Kit includes:</b> (2) Tilt-latches (2) Wash assists <a href="#">Service Guide 0005417</a>	<b>Finish</b>	<b>Order No.</b>
		White	0102091
 <b>Tilt-Latches</b>		Gray	0102092
<b>Latch Screw</b>			
			<b>Order No.</b>
			0102011
<b>Limited Travel Bumper</b>			
<b>Note:</b> Use to replace all previous vintage bumpers. Also order screws, 0112045. Both come as a package of two.			
			<b>Package of 2</b>
			0112044
<b>Vent Limiter Kit</b>			
	<b>Kit includes:</b> (20) Bumpers (20) Fasteners <a href="#">Installation Guide 0005510</a>	<b>Type</b>	<b>Order No.</b>
		Commercial	0102096
		Residential	0102095
<b>Chimney Plug - Foam</b>			
			<b>Gray</b>
			9131658
<b>Glass Clip (Klick Fastener) - Picture and Transom Units</b>			
			<b>Order No.</b>
			0102080

## Frames

### Exterior Trim Stop Cover

**Note:**

Exterior stop cover snaps into outside frame member creating a finished look between the insert window and the existing exterior window trim. Available as a single piece. Cut trim stop cover to desired width.

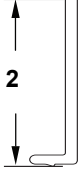
	<b>Length</b>	<b>Finish</b>	<b>Single Piece</b>
	12 ft.	White	0112072
		Terratone®	0112074
		Sandtone	0112073
		Forest Green	0112075
		Canvas	9064537
		Dark Bronze	9074456
		Black	9131759

### Bumpers

	<b>Finish</b>	<b>Order No.</b>
	White	9019610
	Stone	9019611

### Rods

	<b>Finish</b>	<b>Order No.</b>
	White	9019606
	Stone	9019608

# 400 Series Woodwright® Insert Windows (2005 to Present)

Double-Hung, Picture & Transom Insert Windows

## Joining Components

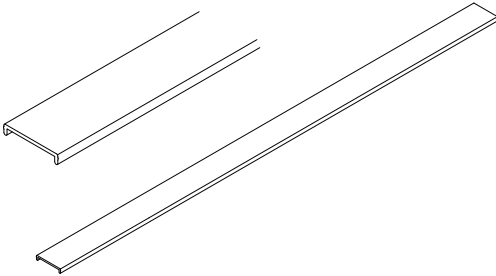
Narrow Joining Parts				
Trim Strip - Exterior Mull				
	Length	Finish	Order No.	
	4 ft.	White	1292078	
		Terratone®	1292080	
		Sandtone	-	
		Forest Green	-	
		Canvas	9064538	
		Dark Bronze	9078217	
		Black	9138794	
	7 ft.	White	0112052	
		Terratone®	0112054	
		Sandtone	0112053	
		Forest Green	0112055	
		Canvas	9064536	
		Dark Bronze	9078216	
		Black	9138793	
	12 ft.	White	1292178	
		Terratone®	1292180	
		Sandtone	1292179	
		Forest Green	1292181	
		Canvas	9064539	
		Dark Bronze	9078218	
		Black	9067349	
	Joining Hardware Kit			Order No.
	<b>Kit includes:</b> (2) Joining Brackets (22) Joining Screws <a href="#">Installation Guide</a>			0102022
Joining Screw			Order No.	
<b>Note:</b> Sold individually. 22 screws are required per join. Screws (8 x 1 1/8") are included in joining hardware kit above.			0112077	

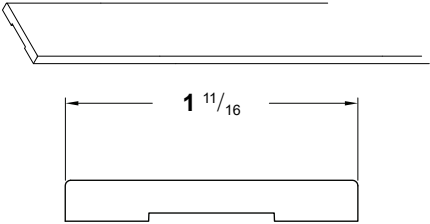
Casing - Interior Mull				
	Length	Finish	Single Piece	Package of 20
	6 ft.	Pine	1611557	0112056
		Maple	0102593	0112057
		Oak	0102591	0112058
		Prefinished White	0102595	0112059
	8 ft.	Pine	0112060	0112064
		Maple	0102594	0112061
		Oak	0102592	0112062
		Prefinished White	0102596	0112063

## Installation Materials

Installation Materials				
Installation Kit - Double-Hung Units				
	<b>Note:</b> One kit is shipped with each double-hung insert window.  <b>Kit includes:</b> (12) Installation Screws (40) installation shims (1/16" thick, quantity 32; 1/32" thick, quantity 8) (15 ft.) 3/8" diameter backer rod	<b>Order No.</b>		
		0112046		
Installation Kit - Picture and Transom Units				
	<b>Note:</b> One kit is shipped with each picture or transom insert window.  <b>Kit includes:</b> (12) Installation Screws (56) installation shims (1/16" thick, quantity 40; 1/32" thick, quantity 16) (25 ft.) 3/8" diameter backer rod	<b>Order No.</b>		
		0102021		
Installation Shim Insert				
		Size	Quantity	Order No.
		1/16"	248	9105773
			2000	0112081
1/32"	2000	0112082		
Installation Screw - Double-Hung Units				
	Description			Order No.
	#8 x 2" panhead			0112047
<b>Note:</b> Used to attach insert frame to existing opening.				
Exterior Trim Stop Cover				
<b>Note:</b> Exterior stop cover snaps into outside frame member creating a finished look between the insert window and the existing exterior window trim. Cut trim stop cover to desired width.				
	Length	Finish	Single Piece	
	12 ft.	White	0112072	
		Terratone®	0112074	
		Sandtone	0112073	
		Forest Green	0112075	
		Canvas	9064537	
		Dark Bronze	9074456	
		Black	9131759	



# 400 Series Woodwright® Insert Windows (2005 to Present)

Double-Hung, Picture & Transom Insert Windows

## Installation Materials

### Stops - Interior

**Note:**

The interior stop can be ripped to desired width. Rip down center of part to obtain two stops approximately 1-1/4" wide. Interior stop profile is reversible after ripping. Use the milled profile to complement Woodwright® insert window sash profile or use reverse side with square edge to trim interior of window.

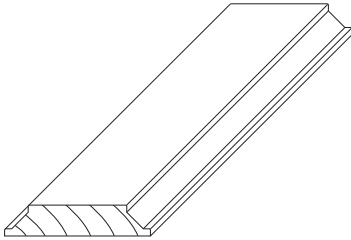

Dimensions (w x l)	Finish	Single
2 21/32 x 48	Pine	0112021
	Maple	0112022
	Oak	0112023
	Prefinished White	0112024
2 21/32 x 84	Pine	0112025
	Maple	0112026
	Oak	0112027
	Prefinished White	0112028

## Installation Materials

---

# 400 Series Woodwright® Insert Windows (2005 to Present)

Service Replacement

Service Replacement Only

## Service Replacement Only Parts

**Note:**

This section is specifically designed for parts that should only be ordered if a Territory Service Manager/Service Provider Company has requested them to be ordered or if the customer agrees to also pay for a non-warranty repair/replace service job (subject to availability) for these parts to be installed. We do not recommend anyone other than a trained AW employee or Service Provider install these parts due to the complexity of installation, modifications required for installation and/or requirement of special tools.

## Sash Interlocks

**Note:**

Specific size upper interlocks made to order. 51-1/2" length interlock can be cut to size if desired.

To order, state:

1. Description of Part (upper sash interlock or lower sash interlock)
2. Quantity
3. Product ID (from product label, see [Service Guide 9051877](#))

### Sash Interlock - Upper

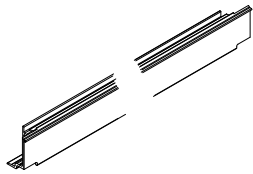

### Sash Interlock - Lower (December 2007 to present)

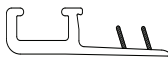

**Note:**

Cut to length. Also order felt spacer and screws.

**Length**

51 1/2

**Order No.**

0102016

### Screw - Lower Interlock

**Description**

PH pan 8 - 15 x 3/8 #5 302 SS

**Order No.**

0102714

### Sash Spacer - Felt / Lower Sash Check Rail

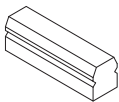

**Note:**

Use on lower sash check rail weatherstrip.

**Order No.**

0102780

## Service Replacement Only

Service Materials		
VHB Tape		
	Dimensions	Order No.
	1/4 x 10 ft.	0102627

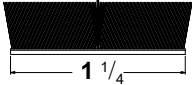
Weatherstrip - Interlock Clash			
	<b>Note:</b> Weatherstrip is 1 1/4" wide with an adhesive back	Color	Order No.
		White	2855171
		Gray	2855137

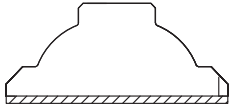
Exterior Grilles - HDN									
Exterior Grille - HDN / Lineal / PVC									
									
Length	White			Terratone			Sandtone		
	3/4"	7/8"	1 1/8"	3/4"	7/8"	1 1/8"	3/4"	7/8"	1 1/8"
60 in	2322030	2322034	2322038	N/A	N/A	N/A	N/A	N/A	N/A
84 in	2322031	2322035	2322039	N/A	N/A	N/A	N/A	N/A	N/A

Jamb Liners	
Jamb Liner - Head	
	<b>Note:</b> Head jamb liners are made to order.  <i>To order, state:</i> 1. Description of Part (head jamb liner) 2. Quantity 3. Product ID (from product label, see <a href="#">Service Guide 9051877</a> )

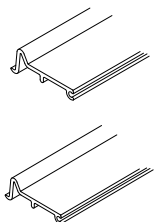
Weatherstrip				
Weatherstrip - Lower Side Jamb				
	<b>Note:</b> Cut to length.	Length	Finish	Order No.
		48	White/Pine	0102721
			Gray/Pine	0102711