

What's in This Section

Monumental Windows	Page 3
Parts Illustration	3
Parts Illustration - Interior View	3
Parts Illustration - Exterior View	4
Unit Sizes	5
Unit Size Chart / Even Monumental	5
Unit Size Chart / Cottage Monumental	6
Unit Size Chart / Reverse Cottage Monumental	7
Product History	8
Product History	8
Sash	9
Sash Size Table - Even	9
Sash Size Table - Cottage	10
Sash Size Table - Reverse Cottage	12
Sash Graphic - Upper	13
Sash Options - Upper	14
Sash Graphic - Lower	15
Sash Options - Lower	16
Weatherstrip	17
Glazing Beads - High Performance / 5/8"	18
Glazing Beads - HDN	20
Sash Hardware - Lock Kits/Components	22
Sash Components / Miscellaneous	23
Sash Balancers	24
Balancer Usage Charts	24
Balancers - Block and Tackle with Shoe	27
Balancers - Block and Tackle with Tab	28
Balancer Parts	28
Insect Screens	29
Insect Screens - Full / Even / TruScene®	29
Insect Screens - Full / Even / Standard Mesh	30
Insect Screens - Half / Even & Cottage / TruScene® (4/2007 - Present)	31
Insect Screens - Half / Even / Standard Mesh (4/2007 - Present)	33
Frames	35
Frame Assembly Graphic	36
Frames	37
Stops (9/2017 - Present)	37

Extension Jamb / Wood / Lineal	38
Extension Jamb / Painted / Lineal	39
Jamb Liners	40
Balancer Cover	40
Balancer Cover Tables (6/2017 - Present)	40
Flange	41
Frame Hardware	42

400 Series Tilt-Wash Monumental Windows (2005 to Present)

Monumental Windows

Parts Illustration

Parts Illustration - Interior View

Note:

Many Monumental window components use "standard" **400 TW** parts.

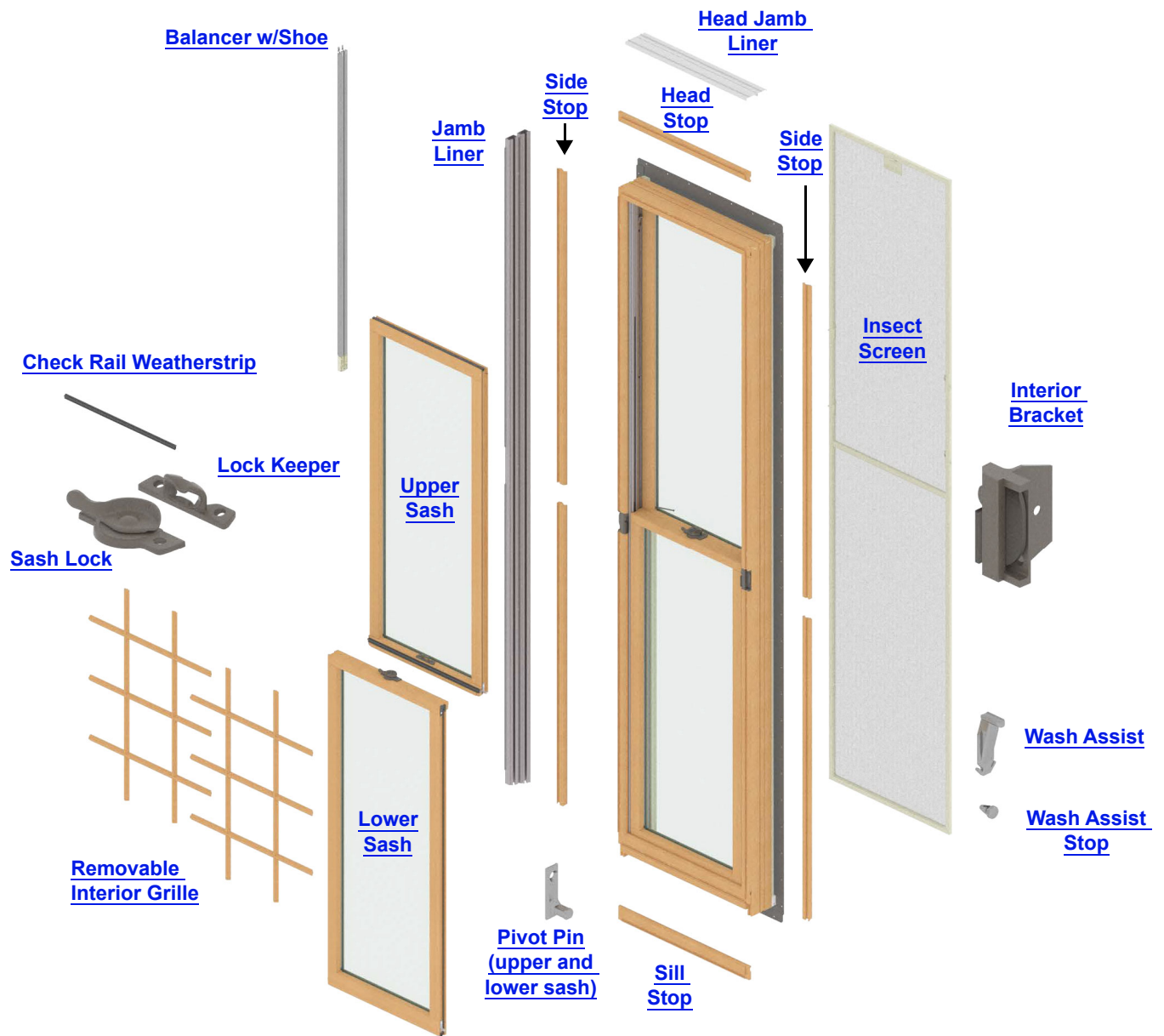

Tilt-Wash Monumental Window Unit Parts

Parts Illustration

Parts Illustration - Exterior View

Note:
Many Monumental window components use "standard" **400 TW** parts.

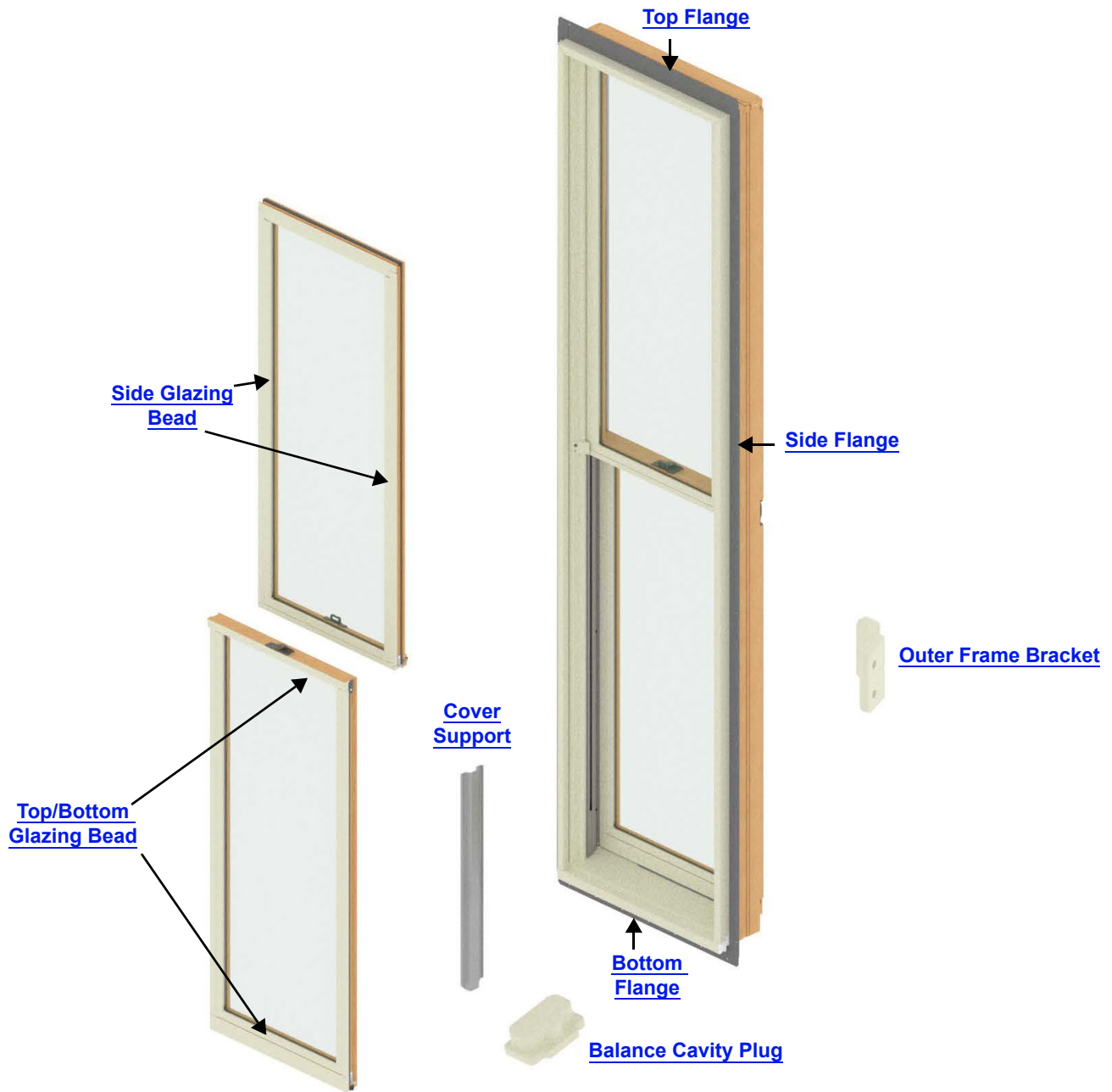

Tilt-Wash Monumental Window Unit Parts

400 Series Tilt-Wash Monumental Windows (2005 to Present)

Monumental Windows

Unit Sizes

Unit Size Chart / Even Monumental

Note:

See [Measuring Visible Glass Video](#).

- 72 & 76 height monumental sizes utilize interior and exterior brackets.

Even Unit Sizes

Table of Tilt-Wash Double-Hung Window Sizes

Scale 1/8" (3) = 1'-0" (305) –1:96

Window Dimension	1'-9 5/8" (549)	2'-1 5/8" (651)	2'-5 5/8" (752)	2'-7 5/8" (803)	2'-9 5/8" (854)	2'-11 5/8" (905)	3'-1 5/8" (956)	3'-5 5/8" (1057)	3'-9 5/8" (1159)
Minimum Rough Opening	1'-10 1/8" (562)	2'-2 1/8" (664)	2'-6 1/8" (765)	2'-8 1/8" (816)	2'-10 1/8" (867)	3'-0 1/8" (917)	3'-2 1/8" (968)	3'-6 1/8" (1070)	3'-10 1/8" (1172)
Unobstructed Glass (lower sash only)	15" (381)	19" (483)	23" (584)	25" (635)	27" (686)	29" (737)	31" (787)	35" (889)	39" (991)

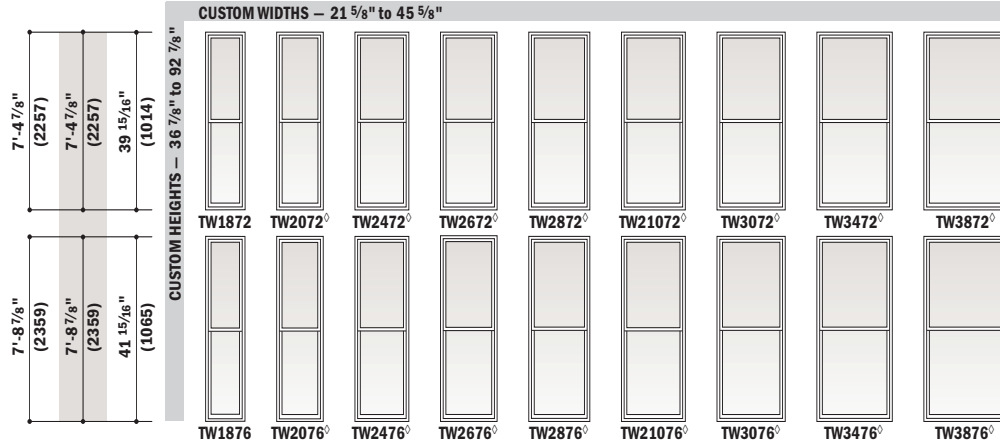

Custom-size windows are available in 1/8" (3) increments.

Windows 7'-4 7/8" (2257) and 7'-8 7/8" (2359) high have interior and exterior brackets. Interior brackets, located on both sides of the meeting rail, must be flipped up for proper product performance. Andersen® reinforced joining materials must be used when vertically joining 7'-4 7/8" (2257) and 7'-8 7/8" (2359) height windows.

- "Window Dimension" always refers to outside frame-to-frame dimension.
- "Minimum Rough Opening" dimensions may need to be increased to allow for use of building wraps, flashing, sill panning, brackets, fasteners or other items.
- Dimensions in parentheses are in millimeters.
- ◊ Meet or exceed clear opening area of 5.7 sq. ft. or 0.53 m², clear opening width of 20" (508) and clear opening height of 24" (610).

Unit Sizes

Unit Size Chart / Cottage Monumental

Note:

See [Measuring Visible Glass Video](#).

- TWXX56 cottage unit uses a 46 upper sash and a 66 lower sash.
- TWXX510 cottage unit uses a 46 upper sash and a 72 lower sash.
- TWXX62 cottage unit uses a 410 upper sash and a 76 lower sash.

Cottage Unit Sizes

Table of Tilt-Wash Double-Hung Window Sizes – Monumental Cottage Sash
Scale 1/8" (3) = 1'-0" (305) – 1:96

Window Dimension	1'-9 5/8" (549)	2'-1 5/8" (651)	2'-5 5/8" (752)	2'-7 5/8" (803)	2'-9 5/8" (854)	2'-11 5/8" (905)	3'-1 5/8" (956)	3'-5 5/8" (1057)	3'-9 5/8" (1159)
Minimum Rough Opening	1'-10 1/8" (562)	2'-2 1/8" (664)	2'-6 1/8" (765)	2'-8 1/8" (816)	2'-10 1/8" (867)	3'-0 1/8" (917)	3'-2 1/8" (968)	3'-6 1/8" (1070)	3'-10 1/8" (1172)
Unobstructed Glass	15" (381)	19" (483)	23" (584)	25" (635)	27" (686)	29" (737)	31" (787)	35" (889)	39" (991)
5'-8 7/8" (1749)									
	TW1856	TW2056	TW2456	TW2656	TW2856	TW21056	TW3056*	TW3456*	TW3856*
6'-0 7/8" (1851)									
	TW18510	TW20510	TW24510	TW26510	TW28510	TW210510	TW30510*	TW34510*	TW38510*
6'-4 7/8" (1953)									
	TW1862	TW2062	TW2462	TW2662	TW2862	TW21062*	TW3062*	TW3462*	TW3862*

- "Window Dimension" always refers to outside frame to frame dimension.
- "Minimum Rough Opening" dimensions may need to be increased to allow for use of building wraps, flashing, sill panning, brackets, fasteners or other items.
- Dimensions in parentheses are in millimeters.
- *Meet or exceed clear opening area of 5.7 sq.ft. or 0.53 m², clear opening width of 20" (508) and clear opening height of 24" (610).

400 Series Tilt-Wash Monumental Windows (2005 to Present)

Monumental Windows

Unit Sizes

Unit Size Chart / Reverse Cottage Monumental

Note:

See [Measuring Visible Glass Video](#).

- TWXX56 reverse cottage unit uses a 66 upper sash and a 46 lower sash.
- TWXX510 reverse cottage unit uses a 72 upper sash and a 46 lower sash.
- TWXX62 reverse cottage unit uses a 76 upper sash and a 410 lower sash.

Reverse Cottage Unit Sizes

Table of Tilt-Wash Double-Hung Window Sizes – Monumental Reverse Cottage Sash
Scale 1/8" (3) = 1'-0" (305) – 1:96

Window Dimension	1'-9 5/8"	2'-1 5/8"	2'-5 5/8"	2'-7 5/8"	2'-9 5/8"	2'-11 5/8"	3'-1 5/8"	3'-5 5/8"	3'-9 5/8"
	(549)	(651)	(752)	(803)	(854)	(905)	(956)	(1057)	(1159)
Minimum Rough Opening	1'-10 1/8"	2'-2 1/8"	2'-6 1/8"	2'-8 1/8"	2'-10 1/8"	3'-0 1/8"	3'-2 1/8"	3'-6 1/8"	3'-10 1/8"
	(562)	(664)	(765)	(816)	(867)	(917)	(968)	(1070)	(1172)
Unobstructed Glass	15"	19"	23"	25"	27"	29"	31"	35"	39"
	(381)	(483)	(584)	(635)	(686)	(737)	(787)	(889)	(991)
5'-8 7/8"									
	(1749)	(1749)	(1749)	(1749)	(1749)	(1749)	(1749)	(1749)	(1749)
	5'-8 7/8"	5'-8 7/8"	35 15/16"	23 15/16"					
	(1749)	(1749)	(913)	(608)					
	TW1856	TW2056	TW2456	TW2656	TW2856	TW21056	TW3056*	TW3456*	TW3856*
6'-0 7/8"									
	(1851)	(1851)	(1851)	(1851)	(1851)	(1851)	(1851)	(1851)	(1851)
	6'-0 7/8"	6'-0 7/8"	39 15/16"	23 15/16"					
	(1851)	(1851)	(1014)	(608)					
	TW18510	TW20510	TW24510	TW26510	TW28510	TW210510	TW30510*	TW34510*	TW38510*
6'-4 7/8"									
	(1953)	(1953)	(1953)	(1953)	(1953)	(1953)	(1953)	(1953)	(1953)
	6'-4 7/8"	6'-4 7/8"	41 15/16"	25 15/16"					
	(1953)	(1953)	(1065)	(659)					
	TW1862	TW2062	TW2462	TW2662	TW2862	TW21062*	TW3062*	TW3462*	TW3862*

- "Window Dimension" always refers to outside frame to frame dimension.
- "Minimum Rough Opening" dimensions may need to be increased to allow for use of building wraps, flashing, sill panning, brackets, fasteners or other items.
- Dimensions in parentheses are in millimeters.
- ♦ Meet or exceed clear opening area of 5.7 sq.ft. or 0.53 m², clear opening width of 20" (508) and clear opening height of 24" (610).

Product History

Product History

- | | |
|-------------|---|
| 2016 | Black color introduced. |
| 2013 | Dark Bronze and Canvas colors introduced. |
| 2008 | SmartSun™ glass introduced. |
| 2006 | Additional sizes introduced. See DH-605. |
| 2005 | 72 and 76 (Monumental) height introduced. |

400 Series Tilt-Wash Monumental Windows (2005 to Present)

Monumental Windows

Sash

Sash Size Table - Even

Note:

- Upper and Lower Sash is measured outside edge to outside edge of sash frame.
- Unobstructed Glass is measured from outside edge to outside edge of visible glass only. See [Measuring Visible Glass Video](#).

Unit Size		Upper Sash			Lower Sash		
Unit No.		Overall Sash (w x h)	Unobstructed Glass (w x h)	Actual Glass (w x h)	Overall Sash (w x h)	Unobstructed Glass (w x h)	Actual Glass (w x h)
18	TW1872	18 ¹¹ / ₃₂ × 43	15 × 39 ¹⁵ / ₁₆	16 × 40 ³¹ / ₃₂	18 ¹¹ / ₃₂ × 43 ¹³ / ₁₆	15 × 39 ¹⁵ / ₁₆	16 × 40 ³¹ / ₃₂
	TW1876	18 ¹¹ / ₃₂ × 45	15 × 41 ¹⁵ / ₁₆	16 × 42 ³¹ / ₃₂	18 ¹¹ / ₃₂ × 45 ¹³ / ₁₆	15 × 41 ¹⁵ / ₁₆	16 × 42 ³¹ / ₃₂
20	TW2072	22 ¹¹ / ₃₂ × 43	19 × 39 ¹⁵ / ₁₆	20 × 40 ³¹ / ₃₂	22 ¹¹ / ₃₂ × 43 ¹³ / ₁₆	19 × 39 ¹⁵ / ₁₆	20 × 40 ³¹ / ₃₂
	TW2076	22 ¹¹ / ₃₂ × 45	19 × 41 ¹⁵ / ₁₆	20 × 42 ³¹ / ₃₂	22 ¹¹ / ₃₂ × 45 ¹³ / ₁₆	19 × 41 ¹⁵ / ₁₆	20 × 42 ³¹ / ₃₂
24	TW2472	26 ¹¹ / ₃₂ × 43	23 × 39 ¹⁵ / ₁₆	24 × 40 ³¹ / ₃₂	26 ¹¹ / ₃₂ × 43 ¹³ / ₁₆	23 × 39 ¹⁵ / ₁₆	24 × 40 ³¹ / ₃₂
	TW2476	26 ¹¹ / ₃₂ × 45	23 × 41 ¹⁵ / ₁₆	24 × 42 ³¹ / ₃₂	26 ¹¹ / ₃₂ × 45 ¹³ / ₁₆	23 × 41 ¹⁵ / ₁₆	24 × 42 ³¹ / ₃₂
26	TW2672	28 ¹¹ / ₃₂ × 43	25 × 39 ¹⁵ / ₁₆	26 × 40 ³¹ / ₃₂	28 ¹¹ / ₃₂ × 43 ¹³ / ₁₆	25 × 39 ¹⁵ / ₁₆	26 × 40 ³¹ / ₃₂
	TW2676	28 ¹¹ / ₃₂ × 45	25 × 41 ¹⁵ / ₁₆	26 × 42 ³¹ / ₃₂	28 ¹¹ / ₃₂ × 45 ¹³ / ₁₆	25 × 41 ¹⁵ / ₁₆	26 × 42 ³¹ / ₃₂
28	TW2872	30 ¹¹ / ₃₂ × 43	27 × 39 ¹⁵ / ₁₆	28 × 40 ³¹ / ₃₂	30 ¹¹ / ₃₂ × 43 ¹³ / ₁₆	27 × 39 ¹⁵ / ₁₆	28 × 40 ³¹ / ₃₂
	TW2876	30 ¹¹ / ₃₂ × 45	27 × 41 ¹⁵ / ₁₆	28 × 42 ³¹ / ₃₂	30 ¹¹ / ₃₂ × 45 ¹³ / ₁₆	27 × 41 ¹⁵ / ₁₆	28 × 42 ³¹ / ₃₂
210	TW21072	32 ¹¹ / ₃₂ × 43	29 × 39 ¹⁵ / ₁₆	30 × 40 ³¹ / ₃₂	32 ¹¹ / ₃₂ × 43 ¹³ / ₁₆	29 × 39 ¹⁵ / ₁₆	30 × 40 ³¹ / ₃₂
	TW21076	32 ¹¹ / ₃₂ × 45	29 × 41 ¹⁵ / ₁₆	30 × 42 ³¹ / ₃₂	32 ¹¹ / ₃₂ × 45 ¹³ / ₁₆	29 × 41 ¹⁵ / ₁₆	30 × 42 ³¹ / ₃₂
30	TW3072	34 ¹¹ / ₃₂ × 43	31 × 39 ¹⁵ / ₁₆	32 × 40 ³¹ / ₃₂	34 ¹¹ / ₃₂ × 43 ¹³ / ₆₄	31 × 39 ¹⁵ / ₁₆	32 × 40 ³¹ / ₃₂
	TW3076	34 ¹¹ / ₃₂ × 45	31 × 41 ¹⁵ / ₁₆	32 × 42 ³¹ / ₃₂	34 ¹¹ / ₃₂ × 45 ¹³ / ₁₆	31 × 41 ¹⁵ / ₁₆	32 × 42 ³¹ / ₃₂
34	TW3472	38 ¹¹ / ₃₂ × 43	35 × 39 ¹⁵ / ₁₆	36 × 40 ³¹ / ₃₂	38 ¹¹ / ₃₂ × 43 ¹³ / ₁₆	35 × 39 ¹⁵ / ₁₆	36 × 40 ³¹ / ₃₂
	TW3476	38 ¹¹ / ₃₂ × 45	35 × 41 ¹⁵ / ₁₆	36 × 42 ³¹ / ₃₂	38 ¹¹ / ₃₂ × 45 ¹³ / ₆₄	35 × 41 ¹⁵ / ₁₆	36 × 42 ³¹ / ₃₂
38	TW3872	42 ¹¹ / ₃₂ × 43	39 × 39 ¹⁵ / ₁₆	40 × 40 ³¹ / ₃₂	42 ¹¹ / ₃₂ × 43 ¹³ / ₁₆	39 × 39 ¹⁵ / ₁₆	40 × 40 ³¹ / ₃₂
	TW3876	42 ¹¹ / ₃₂ × 45	39 × 41 ¹⁵ / ₁₆	40 × 42 ³¹ / ₃₂	42 ¹¹ / ₃₂ × 45 ¹³ / ₁₆	39 × 41 ¹⁵ / ₁₆	40 × 42 ³¹ / ₃₂

Sash

Sash Size Table - Cottage

Note:

- Upper and Lower Sash is measured outside edge to outside edge of sash frame.
- Unobstructed Glass is measured from outside edge to outside edge of visible glass only. See [Measuring Visible Glass Video](#).
- TWXX56 cottage unit uses a 46 upper sash and a 66 lower sash.
- TWXX510 cottage unit uses a 46 upper sash and a 72 lower sash.
- TWXX62 cottage unit uses a 410 upper sash and a 76 lower sash.

Unit Size		Upper Sash			Lower Sash		
Unit No.	Overall Sash (w x h)	Unobstructed Glass (w x h)	Actual Glass (w x h)	Overall Sash (w x h)	Unobstructed Glass (w x h)	Actual Glass (w x h)	
18	TW1856	18 11/32 x 27 1/2	15 x 24 7/16	16 x 25 15/32	18 11/32 x 39 5/16	15 x 35 7/16	16 x 36 15/32
	TW18510	18 11/32 x 27 1/2	15 x 24 7/16	16 x 25 15/32	18 11/32 x 43 13/16	15 x 39 15/16	16 x 40 31/32
	TW1862	18 11/32 x 29	15 x 25 15/16	16 x 26 31/32	18 11/32 x 45 13/16	15 x 41 15/16	16 x 42 31/32
20	TW2056	22 11/32 x 27 1/2	19 x 24 7/16	20 x 25 15/32	22 11/32 x 39 5/16	19 x 35 7/16	20 x 36 15/32
	TW20510	22 11/32 x 27 1/2	19 x 24 7/16	20 x 25 15/32	22 11/32 x 43 13/16	19 x 39 15/16	20 x 40 31/32
	TW2062	22 11/32 x 29	19 x 25 15/16	20 x 26 31/32	22 11/32 x 45 13/16	19 x 41 15/16	20 x 42 31/32
24	TW2456	26 11/32 x 27 1/2	23 x 24 7/16	24 x 25 15/32	26 11/32 x 39 5/16	23 x 35 7/16	24 x 36 15/32
	TW24510	26 11/32 x 27 1/2	23 x 24 7/16	24 x 25 15/32	26 11/32 x 43 13/16	23 x 39 15/16	24 x 40 31/32
	TW2462	26 11/32 x 29	23 x 25 15/16	24 x 26 31/32	26 11/32 x 45 13/16	23 x 41 15/16	24 x 42 31/32
26	TW2656	28 11/32 x 27 1/2	25 x 24 7/16	26 x 25 15/32	28 11/32 x 39 5/16	25 x 35 7/16	26 x 36 15/32
	TW26510	28 11/32 x 27 1/2	25 x 24 7/16	26 x 25 15/32	28 11/32 x 43 13/16	25 x 39 15/16	26 x 40 31/32
	TW2662	28 11/32 x 29	25 x 25 15/16	26 x 26 31/32	28 11/32 x 45 13/16	25 x 41 15/16	26 x 42 31/32
28	TW2856	30 11/32 x 27 1/2	27 x 24 7/16	28 x 25 15/32	30 11/32 x 39 5/16	27 x 35 7/16	28 x 36 15/32
	TW28510	30 11/32 x 27 1/2	27 x 24 7/16	28 x 25 15/32	30 11/32 x 43 13/16	27 x 39 15/16	28 x 40 31/32
	TW2862	30 11/32 x 29	27 x 25 15/16	28 x 26 31/32	30 11/32 x 45 13/16	27 x 41 15/16	28 x 42 31/32
210	TW21056	32 11/32 x 27 1/2	29 x 24 7/16	30 x 25 15/32	32 11/32 x 39 5/16	29 x 35 7/16	30 x 36 15/32
	TW210510	32 11/32 x 27 1/2	29 x 24 7/16	30 x 25 15/32	32 11/32 x 43 13/16	29 x 39 15/16	30 x 40 31/32
	TW21062	32 11/32 x 29	29 x 25 15/16	30 x 26 31/32	32 11/32 x 45 13/16	29 x 41 15/16	30 x 42 31/32
30	TW3056	34 11/32 x 27 1/2	31 x 24 7/16	32 x 25 15/32	34 11/32 x 39 5/16	31 x 35 7/16	32 x 36 15/32
	TW30510	34 11/32 x 27 1/2	31 x 24 7/16	32 x 25 15/32	34 11/32 x 43 13/16	31 x 39 15/16	32 x 40 31/32
	TW3062	34 11/32 x 29	31 x 25 15/16	32 x 26 31/32	34 11/32 x 45 13/16	31 x 41 15/16	32 x 42 31/32
34	TW33456	38 11/32 x 27 1/2	35 x 24 7/16	36 x 25 15/32	38 11/32 x 39 5/16	35 x 35 7/16	36 x 36 15/32
	TW34510	38 11/32 x 27 1/2	35 x 24 7/16	36 x 25 15/32	38 11/32 x 43 13/16	35 x 39 15/16	36 x 40 31/32
	TW3462	38 11/32 x 29	35 x 25 15/16	36 x 26 31/32	38 11/32 x 45 13/16	35 x 41 15/16	36 x 42 31/32
38	TW3856	42 11/32 x 27 1/2	39 x 24 7/16	40 x 25 15/32	42 11/32 x 39 5/16	39 x 35 7/16	40 x 36 15/32
	TW38510	42 11/32 x 27 1/2	39 x 24 7/16	40 x 25 15/32	42 11/32 x 43 13/16	39 x 39 15/16	40 x 40 31/32
	TW3862	42 11/32 x 29	39 x 25 15/16	40 x 26 31/32	42 11/32 x 45 13/16	39 x 41 15/16	40 x 42 31/32

400 Series Tilt-Wash Monumental Windows (2005 to Present)

Monumental Windows

Sash

Sash Size Table - Reverse Cottage

Note:

- Upper and Lower Sash is measured outside edge to outside edge of sash frame.
- Unobstructed Glass is measured from outside edge to outside edge of visible glass only. See [Measuring Visible Glass Video](#).
- TWXX56 cottage unit uses a 66 upper sash and a 46 lower sash.
- TWXX510 cottage unit uses a 72 upper sash and a 46 lower sash.
- TWXX62 cottage unit uses a 76 upper sash and a 410 lower sash.

Unit Size		Upper Sash			Lower Sash		
Unit No.	Overall Sash (w x h)	Unobstructed Glass (w x h)	Actual Glass (w x h)	Overall Sash (w x h)	Unobstructed Glass (w x h)	Actual Glass (w x h)	
18	TW1856	18 ¹¹ / ₃₂ × 39 ⁵ / ₁₆	15 × 35 ⁷ / ₁₆	16 × 36 ¹⁵ / ₃₂	18 ¹¹ / ₃₂ × 27 ¹ / ₂	15 × 24 ⁷ / ₁₆	16 × 25 ¹⁵ / ₃₂
	TW18510	18 ¹¹ / ₃₂ × 43 ¹³ / ₁₆	15 × 39 ¹⁵ / ₁₆	16 × 40 ³¹ / ₃₂	18 ¹¹ / ₃₂ × 27 ¹ / ₂	15 × 24 ⁷ / ₁₆	16 × 25 ¹⁵ / ₃₂
	TW1862	18 ¹¹ / ₃₂ × 45 ¹³ / ₁₆	15 × 41 ¹⁵ / ₁₆	16 × 42 ³¹ / ₃₂	18 ¹¹ / ₃₂ × 29	15 × 25 ¹⁵ / ₁₆	16 × 26 ³¹ / ₃₂
20	TW2056	22 ¹¹ / ₃₂ × 39 ⁵ / ₁₆	19 × 35 ⁷ / ₁₆	20 × 36 ¹⁵ / ₃₂	22 ¹¹ / ₃₂ × 27 ¹ / ₂	19 × 24 ⁷ / ₁₆	20 × 25 ¹⁵ / ₃₂
	TW20510	22 ¹¹ / ₃₂ × 43 ¹³ / ₁₆	19 × 39 ¹⁵ / ₁₆	20 × 40 ³¹ / ₃₂	22 ¹¹ / ₃₂ × 27 ¹ / ₂	19 × 24 ⁷ / ₁₆	20 × 25 ¹⁵ / ₃₂
	TW2062	22 ¹¹ / ₃₂ × 45 ¹³ / ₁₆	19 × 41 ¹⁵ / ₁₆	20 × 42 ³¹ / ₃₂	22 ¹¹ / ₃₂ × 29	19 × 25 ¹⁵ / ₁₆	20 × 26 ³¹ / ₃₂
24	TW2456	26 ¹¹ / ₃₂ × 39 ⁵ / ₁₆	23 × 35 ⁷ / ₁₆	24 × 36 ¹⁵ / ₃₂	26 ¹¹ / ₃₂ × 27 ¹ / ₂	23 × 24 ⁷ / ₁₆	24 × 25 ¹⁵ / ₃₂
	TW24510	26 ¹¹ / ₃₂ × 43 ¹³ / ₁₆	23 × 39 ¹⁵ / ₁₆	24 × 40 ³¹ / ₃₂	26 ¹¹ / ₃₂ × 27 ¹ / ₂	23 × 24 ⁷ / ₁₆	24 × 25 ¹⁵ / ₃₂
	TW2462	26 ¹¹ / ₃₂ × 45 ¹³ / ₁₆	23 × 41 ¹⁵ / ₁₆	24 × 42 ³¹ / ₃₂	26 ¹¹ / ₃₂ × 29	23 × 25 ¹⁵ / ₁₆	24 × 26 ³¹ / ₃₂
26	TW2656	28 ¹¹ / ₃₂ × 39 ⁵ / ₁₆	25 × 35 ⁷ / ₁₆	26 × 36 ¹⁵ / ₃₂	28 ¹¹ / ₃₂ × 27 ¹ / ₂	25 × 24 ⁷ / ₁₆	26 × 25 ¹⁵ / ₃₂
	TW26510	28 ¹¹ / ₃₂ × 43 ¹³ / ₁₆	25 × 39 ¹⁵ / ₁₆	26 × 40 ³¹ / ₃₂	28 ¹¹ / ₃₂ × 27 ¹ / ₂	25 × 24 ⁷ / ₁₆	26 × 25 ¹⁵ / ₃₂
	TW2662	28 ¹¹ / ₃₂ × 45 ¹³ / ₁₆	25 × 41 ¹⁵ / ₁₆	26 × 42 ³¹ / ₃₂	28 ¹¹ / ₃₂ × 29	25 × 25 ¹⁵ / ₁₆	26 × 26 ³¹ / ₃₂
28	TW2856	30 ¹¹ / ₃₂ × 39 ⁵ / ₁₆	27 × 35 ⁷ / ₁₆	28 × 36 ¹⁵ / ₃₂	30 ¹¹ / ₃₂ × 27 ¹ / ₂	27 × 24 ⁷ / ₁₆	28 × 25 ¹⁵ / ₃₂
	TW28510	30 ¹¹ / ₃₂ × 43 ¹³ / ₁₆	27 × 39 ¹⁵ / ₁₆	28 × 40 ³¹ / ₃₂	30 ¹¹ / ₃₂ × 27 ¹ / ₂	27 × 24 ⁷ / ₁₆	28 × 25 ¹⁵ / ₃₂
	TW2862	30 ¹¹ / ₃₂ × 45 ¹³ / ₁₆	27 × 41 ¹⁵ / ₁₆	28 × 42 ³¹ / ₃₂	30 ¹¹ / ₃₂ × 29	27 × 25 ¹⁵ / ₁₆	28 × 26 ³¹ / ₃₂
210	TW21056	32 ¹¹ / ₃₂ × 39 ⁵ / ₁₆	29 × 35 ⁷ / ₁₆	30 × 36 ¹⁵ / ₃₂	32 ¹¹ / ₃₂ × 27 ¹ / ₂	29 × 24 ⁷ / ₁₆	30 × 25 ¹⁵ / ₃₂
	TW210510	32 ¹¹ / ₃₂ × 43 ¹³ / ₁₆	29 × 39 ¹⁵ / ₁₆	30 × 40 ³¹ / ₃₂	32 ¹¹ / ₃₂ × 27 ¹ / ₂	29 × 24 ⁷ / ₁₆	30 × 25 ¹⁵ / ₃₂
	TW21062	32 ¹¹ / ₃₂ × 45 ¹³ / ₁₆	29 × 41 ¹⁵ / ₁₆	30 × 42 ³¹ / ₃₂	32 ¹¹ / ₃₂ × 29	29 × 25 ¹⁵ / ₁₆	30 × 26 ³¹ / ₃₂
30	TW3056	34 ¹¹ / ₃₂ × 39 ⁵ / ₁₆	31 × 35 ⁷ / ₁₆	32 × 36 ¹⁵ / ₃₂	34 ¹¹ / ₃₂ × 27 ¹ / ₂	31 × 24 ⁷ / ₁₆	32 × 25 ¹⁵ / ₃₂
	TW30510	34 ¹¹ / ₃₂ × 43 ¹³ / ₁₆	31 × 39 ¹⁵ / ₁₆	32 × 40 ³¹ / ₃₂	34 ¹¹ / ₃₂ × 27 ¹ / ₂	31 × 24 ⁷ / ₁₆	32 × 25 ¹⁵ / ₃₂
	TW3062	34 ¹¹ / ₃₂ × 45 ¹³ / ₁₆	31 × 41 ¹⁵ / ₁₆	32 × 42 ³¹ / ₃₂	34 ¹¹ / ₃₂ × 29	31 × 25 ¹⁵ / ₁₆	32 × 26 ³¹ / ₃₂
34	TW33456	38 ¹¹ / ₃₂ × 39 ⁵ / ₁₆	35 × 35 ⁷ / ₁₆	36 × 36 ¹⁵ / ₃₂	38 ¹¹ / ₃₂ × 27 ¹ / ₂	35 × 24 ⁷ / ₁₆	36 × 25 ¹⁵ / ₃₂
	TW34510	38 ¹¹ / ₃₂ × 43 ¹³ / ₁₆	35 × 39 ¹⁵ / ₁₆	36 × 40 ³¹ / ₃₂	38 ¹¹ / ₃₂ × 27 ¹ / ₂	35 × 24 ⁷ / ₁₆	36 × 25 ¹⁵ / ₃₂
	TW3462	38 ¹¹ / ₃₂ × 45 ¹³ / ₁₆	35 × 41 ¹⁵ / ₁₆	36 × 42 ³¹ / ₃₂	38 ¹¹ / ₃₂ × 29	35 × 25 ¹⁵ / ₁₆	36 × 26 ³¹ / ₃₂
38	TW3856	42 ¹¹ / ₃₂ × 39 ⁵ / ₁₆	39 × 35 ⁷ / ₁₆	40 × 36 ¹⁵ / ₃₂	42 ¹¹ / ₃₂ × 27 ¹ / ₂	39 × 24 ⁷ / ₁₆	40 × 25 ¹⁵ / ₃₂
	TW38510	42 ¹¹ / ₃₂ × 43 ¹³ / ₁₆	39 × 39 ¹⁵ / ₁₆	40 × 40 ³¹ / ₃₂	42 ¹¹ / ₃₂ × 27 ¹ / ₂	39 × 24 ⁷ / ₁₆	40 × 25 ¹⁵ / ₃₂
	TW3862	42 ¹¹ / ₃₂ × 45 ¹³ / ₁₆	39 × 41 ¹⁵ / ₁₆	40 × 42 ³¹ / ₃₂	42 ¹¹ / ₃₂ × 29	39 × 25 ¹⁵ / ₁₆	40 × 26 ³¹ / ₃₂

Sash

Sash Graphic - Upper

Note:

See latest [Product Details](#). Configure through iQ+.

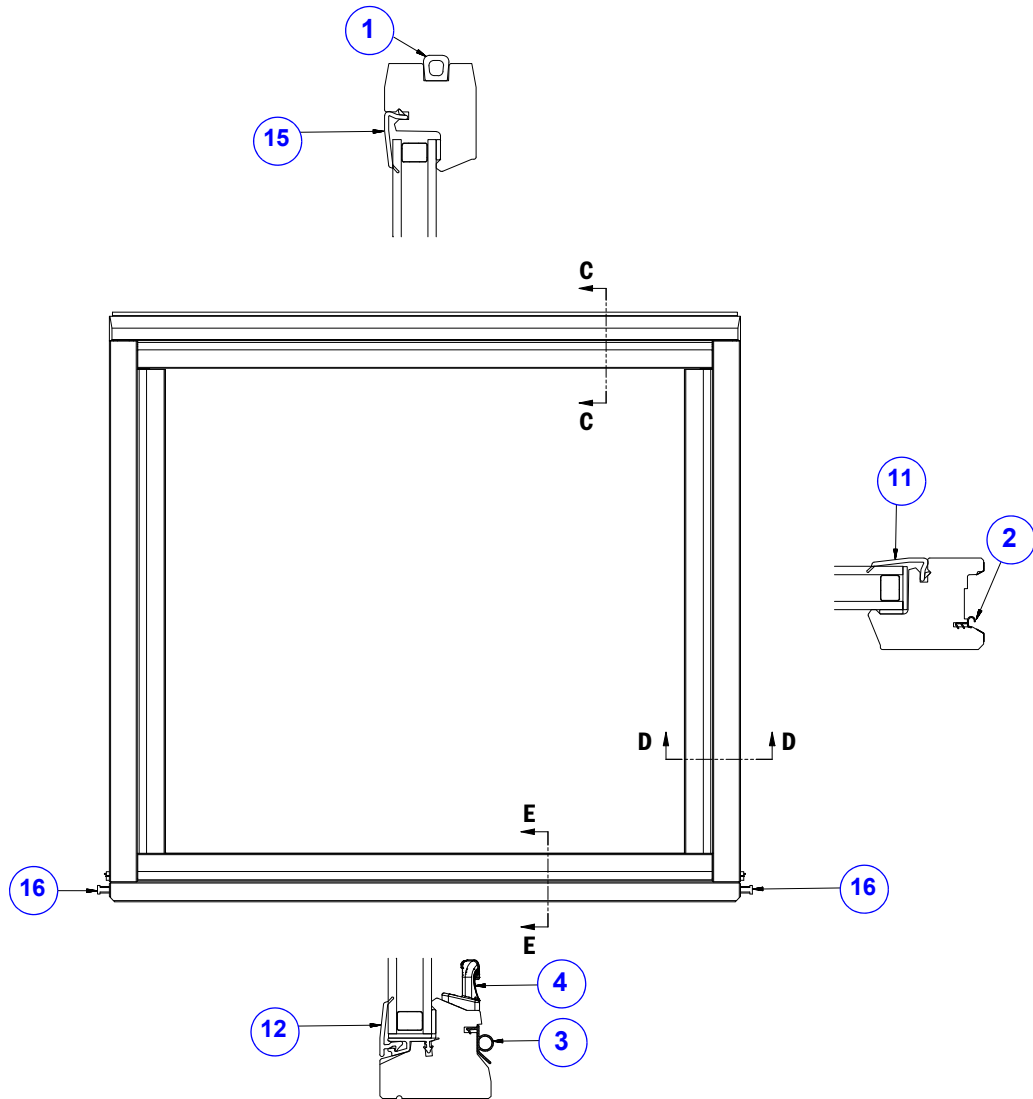

- | | |
|--|---|
| 1. Top Rail Weatherstrip | 11. Stile Glazing Bead |
| 2. Stile Weatherstrip | 12. Check Rail Vinyl Glazing Bead |
| 3. Check Rail Weatherstrip | 13. Check Rail Bead Liner |
| 4. Lock Keeper | 14. Silicone Glazing |
| 6. Top Rail | 15. Top Rail Glazing Bead |
| 7. Right Stile | 16. Pivot Pin |
| 8. Left Stile | |
| 9. Check Rail | |

Tilt-Wash Monumental Upper Sash

Sash Options - Upper

Sash - Standard Window

Note:

Replacement sash for windows are made to order and can be configured through iQ+. Current glazings replace previous vintage glazings. Product ID label is located on the head jamb.



TEMPERED
16 CFR 1201 II
ANSI Z97.1 2009
SGCC XXXX
CIG-XX Xmm MM/DD/YR
CAN/CGSB 12.1-M90

Exterior color options:

Interior species/finish/color options:

Glass options (See Logo/Etching Examples):

Low-E4®	Low-E4® HeatLock	Low-E4® Triple-Pane
Low-E4® SmartSun™	Low-E4® Smart-Sun HeatLock	Low-E4® Smart-Sun Triple-Pane
Low-E4® Passive Sun	Low-E4® Sun Heat-Lock	Low-E4® Enhanced Triple-Pane
Low-E4® Sun 3	Low-E4® HeatLock Tempered	Low-E4® Smart-Sun Enhanced Triple-Pane
Low-E4® Tempered	Dual Pane Clear	Low-E4® Enhanced Triple-Pane Heat-Lock
Low-E4® SmartSun Tempered	Cascade	Low-E4® Smart-Sun Enhanced Triple-Pane HeatLock
Low-E4® Passive Sun Tempered	Fern	
Low-E4® Sun Tempered	Reed	

To order, state:

Product ID (from product label, see [Service Guide 9051877](#))

OR

1. Unit or frame size (TW XXXX or frame W x H dimensions)
2. Unit sash ratio (Even, Cottage, Rev Cottage, SSR)
3. Description of part (Upper Sash)
4. Exterior color of sash
5. Keeper finish and quantity (One or two). 30 width and wider require two.
6. Glazing/Grille type

Sash

Sash Graphic - Lower

Note:

See latest [Product Details](#). Configure through iQ+.

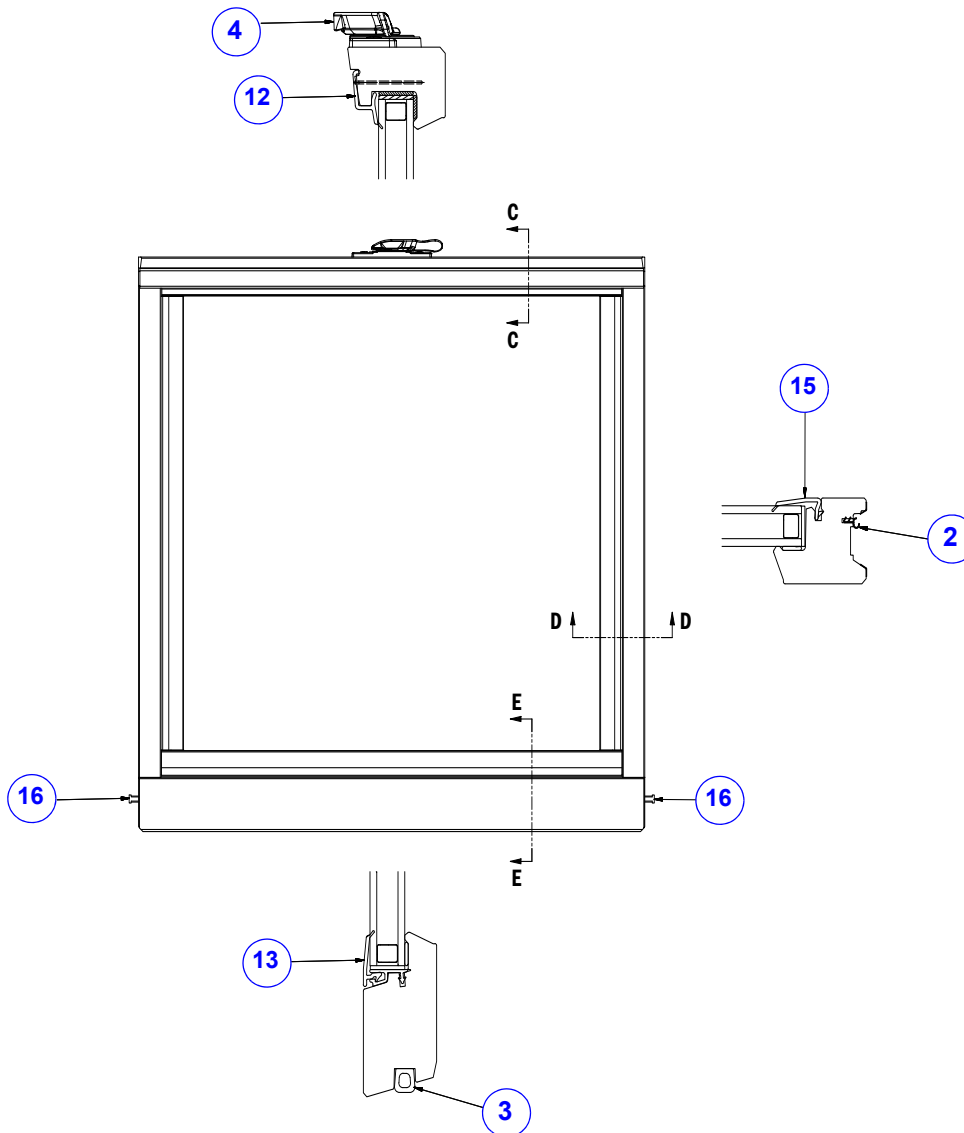

- | | |
|---|---|
| 1. Silicone Glazing | 9. Bottom Rail |
| 2. Stile Weatherstrip | 12. Lower Check Rail Glazing Bead |
| 3. Bottom Rail Weatherstrip | 13. Bottom Rail Glazing Bead |
| 4. Sash Lock | 14. Bottom Rail Glazing Bead Channel |
| 6. Check Rail | 15. Stile Glazing Bead |
| 7. Right Stile | 16. Pivot Pin |
| 8. Left Stile | |

Tilt-Wash Double-Hung Lower Sash

Sash Options - Lower

Sash - Standard Window

Note:

Replacement sash for windows are made to order and can be configured through iQ+. Current glazings replace previous vintage glazings. Product ID label is located on the head jamb.

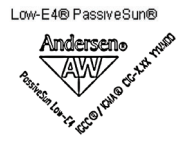

TEMPERED UA
16 CFR 1201 II
ANSI Z97.1 2009
SGCC XXXX
CIG-XX Xmm MM/DD/YR
CAN/CGSB 12.1-M90

Exterior color options:

Interior species/finish/color options:

Glass options (See Logo/Etching Examples):

Low-E4®	Low-E4® HeatLock	Low-E4® Triple-Pane
Low-E4® SmartSun™	Low-E4® Smart-Sun HeatLock	Low-E4® Smart-Sun Triple-Pane
Low-E4® Passive Sun	Low-E4® Sun Heat-Lock	Low-E4® Enhanced Triple-Pane
Low-E4® Sun 3	Low-E4® HeatLock Tempered	Low-E4® Smart-Sun Enhanced Triple-Pane
Low-E4® Tempered	Dual Pane Clear	Low-E4® Enhanced Triple-Pane Heat-Lock
Low-E4® SmartSun Tempered	Cascade	Low-E4® Smart-Sun Enhanced Triple-Pane HeatLock
Low-E4® Passive Sun Tempered	Fern	
Low-E4® Sun Tempered	Reed	

To order, state:

Product ID (from product label, see [Service Guide 9051877](#))

OR

1. Unit or frame size (TW XXXX or frame W x H dimensions)
2. Unit sash ratio (Even, Cottage, Rev Cottage, SSR)
3. Description of part (Lower Sash)
4. Exterior color of sash
5. Lock finish and quantity (One or two). 30 width and wider require two.
6. Glazing/Grille type

Sash

Weatherstrip

Note:

See [Weatherstrip Replacement Video](#) (vintage top/bottom rail weatherstrip shown in video).

Weatherstrip - Top and Bottom Rail (10/2019 - Present) [Ref. No. 1 page 12](#) & [Ref. No. 3 page 14](#)

Note:

Cut to size. Replaces previous vintages of top/bottom rail weatherstrip.

Adhere with 1/8" bead of [Andersen Installation Sealant](#). See [Service Guide 9183983](#).

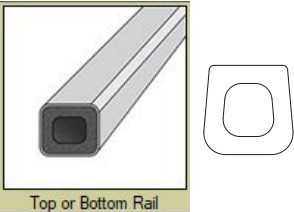
 <p>Top or Bottom Rail</p>		Unit No.	Dimensions	Black
		TW38	42 ⁹ / ₃₂	9181571

Weatherstrip - HDN / Upper Check Rail [Ref. No. 3 page 12](#)

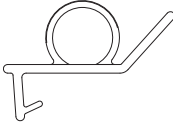
		Unit No.	Dimensions	Order No.
		TW18	18 ⁹ / ₃₂	1631836
		TW20	22 ⁹ / ₃₂	1631837
		TW24	26 ⁹ / ₃₂	1631838
		TW26	28 ⁹ / ₃₂	1631843
		TW28	30 ⁹ / ₃₂	1631839
		TW210	32 ⁹ / ₃₂	1631844
		TW30	34 ⁹ / ₃₂	1631840
		TW34	38 ⁹ / ₃₂	1631841
	TW38	42 ⁹ / ₃₂	1631842	

Weatherstrip - Side / Stile [Ref. No. 2 page 12](#) & [page 14](#)

	<p>Note: Ships as a quantity of one.</p>	Unit No.	Dimensions	Order No.
		TW72	40 ¹⁵ / ₁₆	3870166
		TW76	44 ¹⁵ / ₁₆	3870167
		72 in	72 ¹⁵ / ₁₆	1631514

400 Series Tilt-Wash Monumental Windows (2005 to Present)

Monumental Windows

Sash

Glazing Beads - High Performance / 5/8"

Note:

Glazing bead unit numbers/sizes not listed are available OBD. See [Replacement Video](#).

Glazing Bead - High-Performance / 5/8" / Top Rail

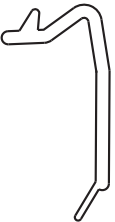
Note: Use on upper sash top rail.	Unit No.	Size	White	Terra-tone®	Sand-tone	Forest Green	Canvas	Dark Bronze	Black
	TW18	16 21/32	1650120	2732520	1152075	0313120	9033967	9073925	9127145
	TW20	20 21/32	1650121	2732521	1152076	0313121	9033968	9073926	9127146
	TW24	24 21/32	1650122	2732522	1152077	0313122	9033969	9073927	9127147
	TW26	26 21/32	1650127	2732527	1152128	0313127	9033970	9073928	9127148
	TW28	28 21/32	1650123	2732523	1152078	0313123	9033971	9073929	9127149
	TW210	30 21/32	1650128	2732528	1152129	0313128	9033972	9073930	9127150
	TW30	32 21/32	1650124	2732524	1152079	0313124	9033973	9073931	9127151
	TW34	36 21/32	1650125	2732525	1152080	0313125	9033974	9073932	9127152
TW38	40 21/32	1650126	2732526	1152081	0313126	9033975	9073933	9127153	

Glazing Bead - High-Performance / 5/8" / Upper Check / Bottom Rail [Ref. No. 13 page 14](#)

Note: Use on upper sash check rail and lower sash bottom rail.	Unit No.	Size	White	Terra-tone®	Sand-tone	Forest Green	Canvas	Dark Bronze	Black
	TW18	16 21/32	1650130	2732530	1152082	0313130	9033976	9073934	9127154
	TW20	20 21/32	1650131	2732531	1152083	0313131	9033977	9073935	9127155
	TW24	24 21/32	1650132	2732532	1152084	0313132	9033978	9073936	9127156
	TW26	26 21/32	1650137	2732529	1152145	0313129	9033979	9073937	9127157
	TW28	28 21/32	1650133	2732533	1152085	0313133	9033980	9073938	9127158
	TW210	30 21/32	1650138	2732537	1152146	0313137	9033981	9073939	9127159
	TW30	32 21/32	1650134	2732534	1152086	0313134	9033982	9073940	9127160
	TW34	36 21/32	1650135	2732535	1152087	0313135	9033983	9073941	9127161
TW38	40 21/32	1650136	2732536	1152088	0313136	9033984	9073942	9127162	

Sash

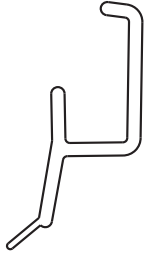
Glazing Bead - High-Performance / 5/8" / Lower Check Rail Ref. No. 12 page 14									
Note: Use on lower sash check rail. 	Unit No.	Size	White	Terra-tone®	Sand-tone	Forest Green	Canvas	Dark Bronze	Black
	TW18	16 21/32	1650140	2732540	1152089	0313140	9033946	9073904	9127124
	TW20	20 21/32	1650141	2732541	1152090	0313141	9033947	9073905	9127125
	TW24	24 21/32	1650142	2732542	1152091	0313142	9033948	9073906	9127126
	TW26	26 21/32	1650139	2732538	1152096	0313138	9033949	9073907	9127127
	TW28	28 21/32	1650143	2732543	1152092	0313143	9033950	9073908	9127128
	TW210	30 21/32	1650147	2732539	1152097	0313139	9033951	9073909	9127129
	TW30	32 21/32	1650144	2732544	1152093	0313144	9033952	9073910	9127130
	TW34	36 21/32	1650145	2732545	1152094	0313145	9033953	9073911	9127131
TW38	40 21/32	1650146	2732546	1152095	0313146	9033954	9073912	9127132	

Glazing Bead - High-Performance / 5/8" / Stile Ref. No. 11 page 12 & Ref. No. 15 page 14									
Note: Use on all stiles. The 310 and 46 height sizes are unique in length with two separate part numbers for the glazing bead used on upper and lower sash. Other height sizes to be used with upper and lower sash. See Dealer Bulletin 61-16 for more details.									
	Unit No.	Size	White	Terra-tone®	Sand-tone	Forest Green	Canvas	Dark Bronze	Black
	TW72	40 1/16	3868832	2732102	1152002	0313102	9033986	9073944	9127164
	TW76	42 1/16	3868834	2732103	1152003	0313103	9033985	9073943	9127163

400 Series Tilt-Wash Monumental Windows (2005 to Present)

Monumental Windows

Sash

Glazing Beads - HDN

Glazing Bead - HDN / Top Rail with End Cap

Note:

Use with units that have HDN grilles beginning in June 2002. Use on upper sash top rail.

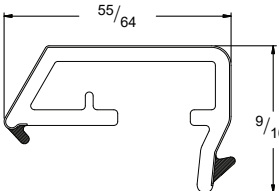
	Unit No.	Size	White	Terra-tone®	Sand-tone	Forest Green	Canvas	Dark Bronze	Black
	TW18	16 ²¹ / ₃₂	1690348	2705170	1102022	0300187	9034012	9073967	9127221
	TW20	20 ²¹ / ₃₂	1690349	2705171	1102023	0300188	9034011	9073966	9127220
	TW24	24 ²¹ / ₃₂	1690350	2705172	1102024	0300189	9034010	9073965	9127219
	TW26	26 ²¹ / ₃₂	1690351	2705173	1102025	0300190	9034009	9073964	9127218
	TW28	28 ²¹ / ₃₂	1690352	2705174	1102026	0300191	9034008	9073963	9127217
	TW210	30 ²¹ / ₃₂	1690353	2705175	1102027	0300192	9034007	9073962	9127216
	TW30	32 ²¹ / ₃₂	1690354	2705176	1102028	0300193	9034006	9073961	9127215
	TW34	36 ²¹ / ₃₂	1690355	2705177	1102029	0300194	9034005	9073960	9127214
TW38	40 ²¹ / ₃₂	1690356	2705178	1102030	0300195	9034004	9073959	9127213	

Bead - HDN / Upper Check / Bottom Rail with End Cap

Note:

Use with units that have HDN grilles beginning in June 2002. Use on upper sash check rail and lower sash bottom rail.

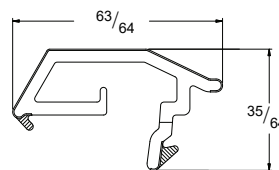
	Unit No.	Size	White	Terra-tone®	Sand-tone	Forest Green	Canvas	Dark Bronze	Black
	TW18	16 ²¹ / ₃₂	1690334	2705156	1102008	0300173	9034021	9073976	9127187
	TW20	20 ²¹ / ₃₂	1690335	2705157	1102009	0300174	9034020	9073975	9127186
	TW24	24 ²¹ / ₃₂	1690336	2705158	1102010	0300175	9034019	9073974	9127185
	TW26	26 ²¹ / ₃₂	1690337	2705159	1102011	0300176	9034018	9073973	9127184
	TW28	28 ²¹ / ₃₂	1690338	2705160	1102012	0300177	9034017	9073972	9127183
	TW210	30 ²¹ / ₃₂	1690339	2705161	1102013	0300178	9034016	9073971	9127182
	TW30	32 ²¹ / ₃₂	1690340	2705162	1102014	0300179	9034015	9073970	9127181
	TW34	36 ²¹ / ₃₂	1690341	2705163	1102015	0300180	9034014	9073969	9127180
TW38	40 ²¹ / ₃₂	1690342	2705164	1102016	0300181	9034013	9073968	9127179	

Sash

Glazing Bead - HDN / Lower Check Rail

Note:

Use with units that have HDN grilles beginning in June 2002. Use on lower sash check rail.

	Unit No.	Size	White	Terra-tone®	Sand-tone	Forest Green	Canvas	Dark Bronze	Black
	TW18	16 ²¹ / ₃₂	1690362	2705184	1102036	0300202	9034030	9073985	9127196
	TW20	20 ²¹ / ₃₂	1690363	2705185	1102037	0300203	9034029	9073984	9127195
	TW24	24 ²¹ / ₃₂	1690364	2705186	1102038	0300204	9034028	9073983	9127194
	TW26	26 ²¹ / ₃₂	1690365	2705187	1102039	0300205	9034027	9073982	9127193
	TW28	28 ²¹ / ₃₂	1690366	2705188	1102040	0300206	9034026	9073981	9127192
	TW210	30 ²¹ / ₃₂	1690367	2705189	1102041	0300207	9034025	9073980	9127191
	TW30	32 ²¹ / ₃₂	1690368	2705190	1102042	0300208	9034024	9073979	9127190
	TW34	36 ²¹ / ₃₂	1690369	2705191	1102043	0300209	9034023	9073978	9127189
	TW38	40 ²¹ / ₃₂	1690370	2705192	1102044	0300210	9034022	9073977	9127188

Glazing Bead - HDN / Stile

Note:

Use with units that have HDN grilles beginning in June 2002.. Use on all stiles. The 310 and 46 height sizes are unique in length with two separate part numbers for the glazing bead used on upper and lower sash. Other height sizes to be used with upper **and** lower sash. See Dealer Bulletin 61-16 for more details.

	Unit No.	Size	White	Terra-tone®	Sand-tone	Forest Green	Canvas	Dark Bronze	Black
	TW72	40 ¹ / ₄	1690331	2705153	1102005	0300170	9033991	9073946	9127166
	TW76	42 ¹ / ₄	1690332	2705154	1102006	0300171	9033990	9073945	9127165

400 Series Tilt-Wash Monumental Windows (2005 to Present)

Monumental Windows

Sash

Sash Hardware - Lock Kits/Components

Lock Kit - Flush Mount / Estate

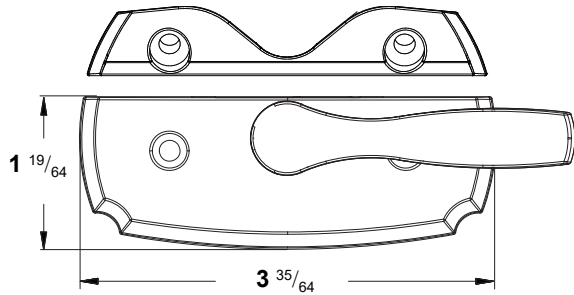

Kit Includes:

- (1) Lock
- (1) Keeper
- (4) Screws

[Accessory Guide 0005256.](#)

Finish	Order No.
Antique Brass	1600695
Bright Brass	1669321
Chrome	1669323
Brushed Chrome	1600406
Satin Nickel	1642924
Oil Rubbed Bronze	1642923
Distressed Bronze	1600407
Distressed Nickel	1600401

Lock Kit - Traditional

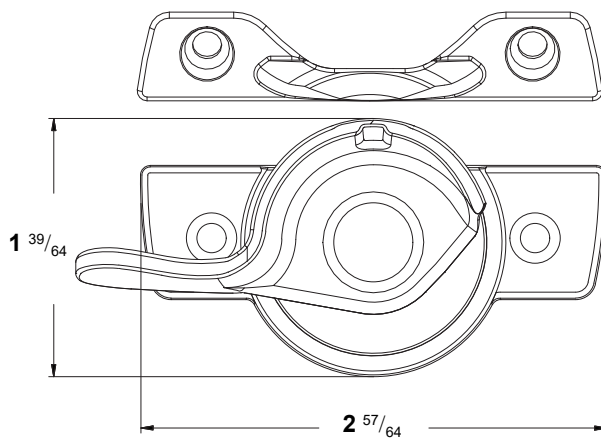

Kit Includes:

- (1) Lock (metal)
- (1) Keeper (metal)
- (4) Screws

Note:

Can be used as an upgrade on sash with flush mount hardware. Used as standard from 2015-present.

Finish	Order No.
Stone	9069432
White	9069433
Black	9069434
Gold Dust	9069435

Sash

Sash Components / Miscellaneous		
Pivot - Sash		
		Order No. 1643018
Screw - Sash Pivot		
	Description 6-10 x 3/4 SCR5 Oval Hd	Order No. 3621996

400 Series Tilt-Wash Monumental Windows (2005 to Present)

Monumental Windows

Sash Balancers

Balancer Usage Charts (1992 - Present)

Note:

T = Balancer with tab.

S = Balancer with shoe.

S & T = Two balancers used: one with shoe and one with tab.

These charts are used to identify balancers for TW (Tilt-Wash) double hung units.

The following charts show the balancers that you need for the upper and the lower sash. A complete unit will use either 4, 6 or 8 balancers.

- If one number is listed this balancer is used on the upper sash as well as the lower sash.
- If two balancer sizes are listed, you need both of those balancers for the upper and both for the lower sash.
- Each sash will use either two (one on each side) or four (two on each side) balancers on each sash, see [page 24](#).
- If an S & T follows a number, you need two balancers for the upper sash, one with a shoe and one with a tab and two for the lower sash, one with a shoe and one with a tab.
- Balancer may be etched with 3 or 4 digit number.

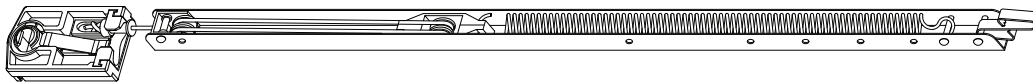

Tilt-Wash Balancer (Block and Tackle with Shoe)

Beginning in April of 2012, glass may be etched with 2.2 or 3.0 etchings. If you have a sash made prior to April of 2012 use glass type to identify balancer needed. If you have a sash made after April 2012 use glass type as well as any 2.2 or 3.0 etching around logo. Glass with 2.2 etchings will use Chart 1 or 3, glass with 3.0 etchings will use Chart 2 or 4. Glass type HP, HP Sun, HP SmartSun™ and HP PassiveSun™ manufactured prior to April 2012 will not have 2.2 etching, but will use Chart 1 or 3.

2.2 Etching



3.0 Etching



Sash Balancers

BALANCER USAGE CHART 1 - TW UNITS (1992 - Present)							
HP (2.2) HP Sun (2.2) HP SmartSun (2.2) HP Passive Sun (2.2)							
Unit No.	Upper and Lower Sash		Order No.	Unit No.	Upper and Lower Sash		
	Balancer				Balancer		
18	TW1872	TW840 ^S	See Charts	210	TW21072	TW1340 ^S	See Charts
	TW1876	TW842 ^S			TW21076	TW1442 ^S	
20	TW2072	TW940 ^S		30	TW3072	TW1440 ^S	
	TW2076	TW1042 ^S			TW3076	TW742 ^T TW842 ^S	
24	TW2472	TW1140 ^S		34	TW3472	TW840 ^S TW740 ^T	
	TW2476	TW1142 ^S			TW3476	TW842 ^S TW842 ^T	
26	TW2672	TW1240 ^S		38	TW3872	TW840 ^T TW940 ^S	
	TW2676	TW1242 ^S			TW3876	TW942 ^S TW942 ^T	
28	TW2872	TW1240 ^S					
	TW2876	TW1342 ^S					

400 Series Tilt-Wash Monumental Windows (2005 to Present)

Monumental Windows

Sash Balancers

BALANCER USAGE CHART 2 - TW UNITS (1992 - Present)							
HP (3.0) HP Sun (3.0) HP SmartSun (3.0) HP Passive Sun (3.0) HP Tempered HP Sun Tempered HP SmartSun Tempered HP Passive Sun Tempered HP Obscure HP Sun Obscure HP SmartSun Obscure HP Passive Sun Obscure			HP Tempered Obscure HP Sun Obscure Tempered HP SmartSun Obscure Tempered HP Passive Sun Obscure Tempered HP Fern HP Sun Fern HP SmartSun Fern HP Passive Sun Fern HP Tempered Fern HP Sun Tempered Fern HP SmartSun Tempered Fern HP Passive Sun Tempered Fern				
Unit No.		Upper and Lower Sash Balancer	Order No.	Unit No.		Upper and Lower Sash Balancer	Order No.
18	TW1872	TW940 ^S	See Charts	210	TW21072	TW840 ^T TW840 ^S	See Charts
	TW1876	TW1042 ^S			TW21076	TW942 ^T TW942 ^S	
20	TW2072	TW1240 ^S		30	TW3072	TW840 ^T TW1040 ^S	
	TW2076	TW1342 ^S			TW3076	TW942 ^T TW1042 ^S	
24	TW2472	TW1440 ^S		34	TW3472	TW1040 ^S TW1040 ^T	
	TW2476	TW742 ^T TW842 ^S			TW3476	TW1142 ^T TW1042 ^S	
26	TW2672	TW740 ^T TW840 ^S		34	TW3872	TW1140 ^T TW1140 ^S	
	TW2676	TW842 ^T TW 842 ^S			TW3876	TW1142 ^T TW1242 ^S	
28	TW2872	TW840 ^T TW 840 ^S					
	TW2876	TW842 ^T TW942 ^S					

Sash Balancers

Balancers - Block and Tackle with Shoe

Note:

Order quantity of two when ordering replacements for a unit manufactured prior to November of 2016.
See [Service Guide 0005176](#) for balancer replacement. See [Balancer Replacement Video](#).

Balancer - Block and Tackle with Shoe

Balancer No.	Order No.	Balancer No.	Order No.	Balancer No.	Order No.	Balancer No.	Order No.	Balancer No.	Order No.	Balancer No.	Order No.
TW310	9151976	TW520.35	9169121	TW712	9151928	TW840	9152236	TW1124	9152210	TW1428	9152226
TW312	9151916	TW522	9152197	TW714	9152184	TW842	9152237	TW1124.35	9160191	TW1430	9160270
TW314	9152180	TW524	9152204	TW716	9152188	TW918	9152153	TW1124.5	-	TW1434	9152179
TW316	9152292	TW524.35	9160185	TW718	9152151	TW920	9152195	TW1124.6	9160201	TW1435	9160271
TW318	9160122	TW524.5	-	TW720	9152193	TW920.35	9169126	TW1125	9151946	TW1436	9160275
TW320	9160123	TW524.6	9160195	TW720.35	9169123	TW922	9152201	TW1126	9152160	TW1436.35	9160223
TW320.35	9169125	TW525	9151920	TW722	9152199	TW924	9152208	TW1128	9152216	TW1436.5	9160276
TW322	9160124	TW526	9152154	TW724	9152206	TW924.35	9160189	TW1130	9152167	TW1437	9151955
TW324.35	9160183	TW528	9160146	TW724.35	9160187	TW924.5	-	TW1132	9152174	TW1438	9160275
TW324.5	-	TW530	9160147	TW724.5	-	TW924.6	9160199	TW1134	9152177	TW1440	9152234
TW324.6	9160193	TW532	9160148	TW724.6	9160197	TW925	9151938	TW1136	9152251	TW1442	9152235
TW325	9160129	TW534	9160149	TW725	9151930	TW926	9152158	TW1136.35	9160220	TW1436.5	9160276
TW326	9160130	TW536	9152245	TW726	9152156	TW928	9152214	TW1136.5	9151947	TW1437	9160277
TW410	9151977	TW536.35	9160214	TW728	9152212	TW930	9152165	TW1137	9151948	TW1438	9160278
TW412	9151917	TW536.5	9151921	TW730	9152163	TW932	9152172	TW1138	9160216	TW1532	9160272
TW414	9152181	TW537	9151922	TW732	9152170	TW934	9152220	TW1140	9152228	TW1534	9160273
TW416	9152185	TW538	9160151	TW734	9152218	TW936	9152249	TW1142	9152229	TW1540	9160279
TW418	9152148	TW540	9160152	TW736	9152247	TW936.35	9160218	TW1224	9160265	TW1634	9160274
TW420	9152190	TW542	9160153	TW736.35	9160216	TW936.5	9151939	TW1224.35	9160192		
TW420.35	9169119	TW610	9151979	TW736.5	9151931	TW937	9151940	TW1224.5	-		
TW422	9160131	TW612	9151923	TW737	9151932	TW938	9160198	TW1224.6	9160202		
TW424	9160132	TW614	9152183	TW738	9160190	TW940	9152238	TW1225	9151949		
TW424.35	9160184	TW616	9152187	TW740	9152223	TW942	9152239	TW1226	9152161		
TW424.5	-	TW618	9152150	TW742	9152224	TW1020	9152196	TW1228	9152217		
TW424.6	9160194	TW620	9152192	TW816	9152189	TW1020.35	9169127	TW1230	9152168		
TW425	9152294	TW620.35	9169122	TW818	9152152	TW1022	9152202	TW1232	9152175		
TW426	9160135	TW622	9152198	TW820	9152194	TW1024	9152209	TW1234	9152222		
TW428	9160136	TW624	9152205	TW820.35	9169124	TW1024.35	9160190	TW1236	9152252		
TW430	9160137	TW624.35	9160186	TW822	9152200	TW1024.5	-	TW1236.35	9160221		
TW432	9160138	TW624.5	-	TW824	9152207	TW1024.6	9160200	TW1238	9160222		
TW434	9160139	TW624.6	9160155	TW824.35	9160188	TW1025	9151942	TW1240	9152230		
TW436	9152244	TW625	9151925	TW824.5	-	TW1026	9152159	TW1242	9152231		
TW436.35	9160213	TW626	9152155	TW824.6	9160198	TW1028	9152215	TW1326	9160267		
TW436.5	9152295	TW628	9152211	TW825	9151934	TW1030	9152166	TW1328	9160268		
TW437	9152296	TW630	9152162	TW826	9152157	TW1032	9152173	TW1330	9160269		
TW438	9160141	TW632	9152169	TW828	9152213	TW1034	9152221	TW1332	9152176		
TW440	9160142	TW634	9160156	TW830	9152164	TW1036	9152250	TW1334	9152178		
TW442	9160143	TW636	9152246	TW832	9152171	TW1036.35	9160219	TW1336	9152253		
TW510	9151978	TW636.35	9160215	TW834	9152219	TW1036.5	9151943	TW1336.35	9160222		
TW512	9151918	TW636.5	9151926	TW836	9152248	TW1037	9151944	TW1336.5	9151952		
TW514	9152182	TW637	9151927	TW836.35	9160217	TW1038	9160202	TW1337	9151953		
TW516	9152186	TW640	9160185	TW836.5	9151935	TW1040	9152225	TW1338	9160268		
TW518	9152149	TW642	9160186	TW837	9151936	TW1042	9152227	TW1340	9152232		
TW520	9152191	TW710	9151980	TW838	9160194	TW1122	9152203	TW1342	9152233		

400 Series Tilt-Wash Monumental Windows (2005 to Present)

Monumental Windows

Sash Balancers

Balancers - Block and Tackle with Tab

Note:

See [Service Guide 0005176](#) for balancer replacement. See [Balancer Replacement Video](#).

Balancer - Block and Tackle with Tab

Balancer No.	Order No.	Balancer No.	Order No.	Balancer No.	Order No.	Balancer No.	Order No.	Balancer No.	Order No.
TW310	9151981	TW636.35	9160224	TW842	9051528	TW1136.35	9160226	TW1432	9160113
TW312	9151956	TW632	1625720	TW918	9160107	TW1136.5	9151968	TW1434	1625723
TW314	1625701	TW636	9152254	TW920	9160108	TW1137	9151969	TW1436.35	9160229
TW416	1625703	TW638	9160116	TW924	1625712	TW1138	9160118	TW1436.5	9159448
TW418	1625705	TW636.5	9151960	TW924.35	9160204	TW1128	1625716	TW1437	9151975
TW420	1625707	TW637	9151961	TW924.5	9151964	TW1142	9051517	TW1438	9160121
TW420.35	9169120	TW718	1625706	TW924.6	9160208	TW1225	9160264	TW1532	9160114
TW522	1625709	TW734	1625722	TW942	9051531	TW1228	9160110	TW1632	9160115
TW524	1625711	TW740	9051532	TW1020	9160182	TW1230	1625719		
TW524.35	9160203	TW742	9051524	TW1024	9160109	TW1236.35	9160227		
TW524.5	9151957	TW820	1625708	TW1024.35	9160205	TW1236.5	9159437		
TW524.6	9160207	TW820.35	9169125	TW1024.6	9160209	TW1237	9151971		
TW525	9151958	TW822	1625710	TW1025	9151965	TW1238	9160119		
TW526	1625713	TW830	1625718	TW1026	1625714	TW1328	9160111		
TW610	9151982	TW836	9152255	TW1036.5	9159427	TW1330	9160112		
TW614	1625702	TW836.35	9160225	TW1037	9151967	TW1332	1625721		
TW612	9151959	TW836.5	9151962	TW1040	9051512	TW1336.35	9160228		
TW616	1625704	TW837	9151963	TW1042	9051514	TW1336.5	9159442		
TW628	1625715	TW838	9160117	TW1124.35	9160206	TW1337	9151973		
TW630	1625717	TW840	9051526	TW1124.6	9160210	TW1338	9160120		

Balancer Parts

Shoe - Balancer

Note:

See [Service Guide 0005176](#) for shoe replacement.

		Order No.
		9152082

Spring Clip - Balancer

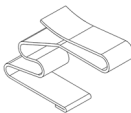
	Order No.
	9045100

Insect Screens

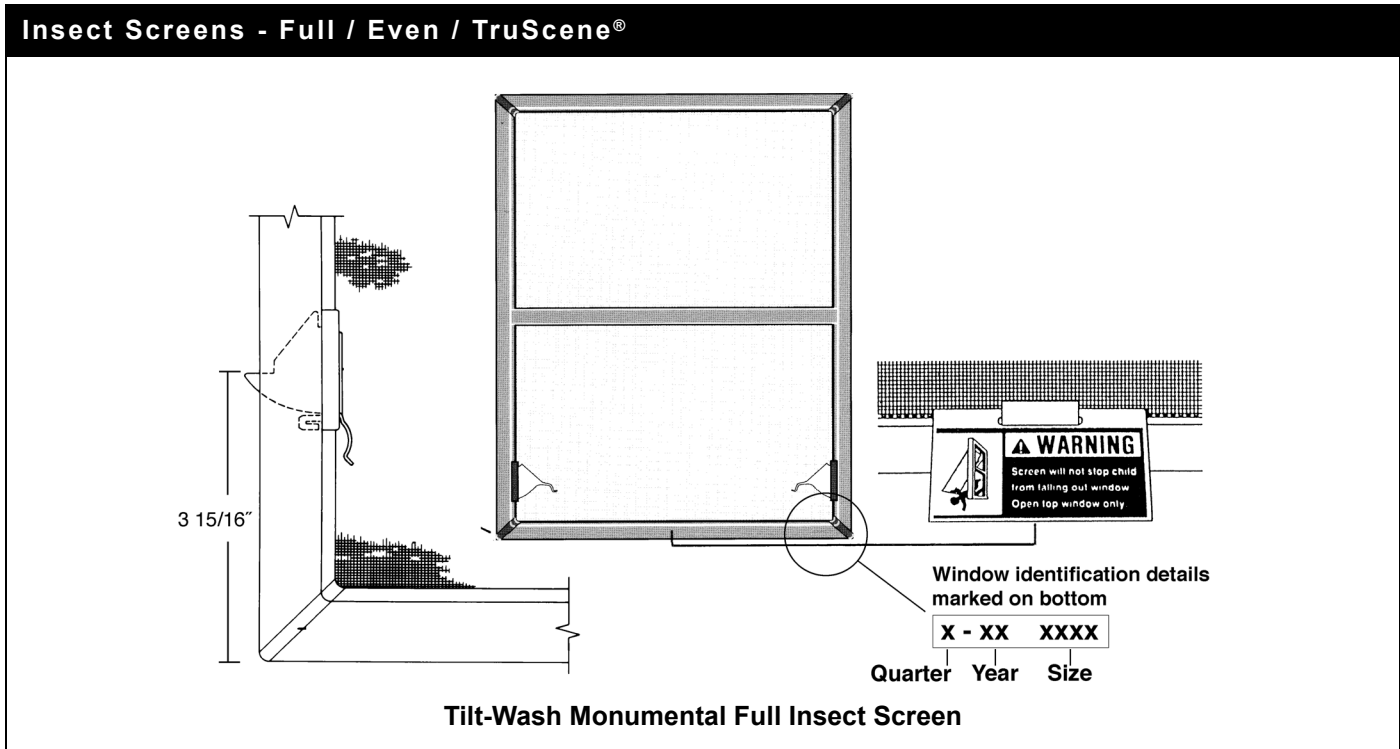

Insect Screen - Full / Equal / TruScene®

Unit No.		Dimensions (w x h)	White	Terra-tone®	Sandtone	Forest Green	Canvas	Dark Bronze	Black
18	1872	19 7/8 × 86 27/32	1634758	2712392	1101592	0300240	9047881	9073232	9128574
	1876	19 7/8 × 90 27/32	1634759	2712393	1101593	0300241	9047882	9073233	9128575
20	2072	23 7/8 × 86 27/32	1634761	2712394	1101594	0300242	9047883	9073234	9128576
	2076	23 7/8 × 90 27/32	1634762	2712395	1101595	0300243	9047884	9073235	9128577
24	2472	27 7/8 × 86 27/32	1634764	2712396	1101596	0300244	9047885	9073236	9128578
	2476	27 7/8 × 90 27/32	1634765	2712397	1101597	0300245	9047886	9073237	9128579
26	2672	29 7/8 × 86 27/32	1611296	2712398	1101598	0300246	9047887	9073238	9128580
	2676	29 7/8 × 90 27/32	1611297	2712399	1101599	0300247	9047888	9073239	9128581
28	2872	31 7/8 × 86 27/32	1634768	2712401	1102201	0300248	9047889	9073240	9128582
	2876	31 7/8 × 90 27/32	1634769	2712402	1102202	0300249	9047890	9073241	9128583
210	21072	33 7/8 × 86 27/32	1611298	2712409	1102209	0300256	9047897	9073248	9128590
	21076	33 7/8 × 90 27/32	1611299	2712410	1102210	0300257	9047898	9073249	9128591
30	3072	35 7/8 × 86 27/32	1634772	2712403	1102203	0300250	9047891	9073242	9128584
	3076	35 7/8 × 90 27/32	1634773	2712404	1102204	0300251	9047892	9073243	9128585
34	3472	39 7/8 × 86 27/32	1634775	2712405	1102205	0300252	9047893	9073244	9128586
	3476	39 7/8 × 90 27/32	1634776	2712406	1102206	0300253	9047894	9073235	9128587
38	3872	43 7/8 × 86 27/32	1634778	2712407	1102207	0300254	9047895	9073246	9128588
	3876	43 7/8 × 90 27/32	1634779	2712408	1102208	0300255	9047896	9073247	9128589

400 Series Tilt-Wash Monumental Windows (2005 to Present)

Monumental Windows

Insect Screens

Insect Screens - Full / Even / Standard Mesh

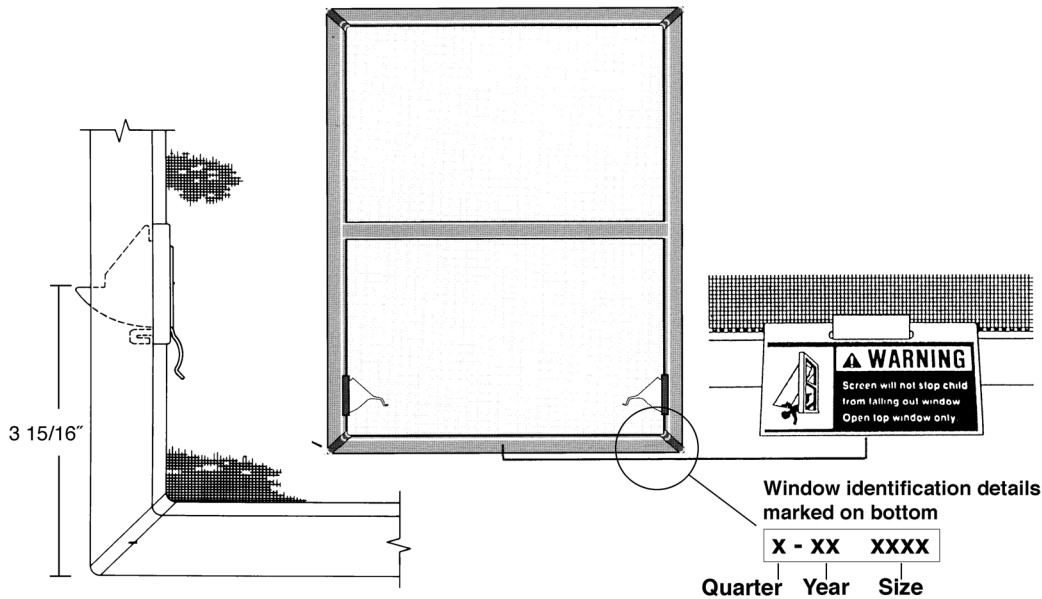

Tilt-Wash Monumental Full Insect Screen

Insect Screen - Full / Equal / Standard Mesh

Unit No.		Dimensions (w x h)	White	Terra-tone®	Sandtone	Forest Green	Canvas	Dark Bronze	Black
18	1872	19 7/8 x 86 27/32	1611058	2700992	1100892	0300140	9047863	9073214	9128556
	1876	19 7/8 x 90 27/32	1611059	2700993	1100893	0300141	9047864	9073215	9128557
20	2072	23 7/8 x 86 27/32	1611061	2700994	1100894	0300142	9047865	9073216	9128558
	2076	23 7/8 x 90 27/32	1611062	2700995	1100895	0300143	9047866	9073217	9128559
24	2472	27 7/8 x 86 27/32	1611064	2700996	1100896	0300144	9047867	9073218	9128560
	2476	27 7/8 x 90 27/32	1611065	2700997	1100897	0300145	9047868	9073219	9128561
26	2672	29 7/8 x 86 27/32	1600696	2700998	1100898	0300146	9047869	9073220	9128562
	2676	29 7/8 x 90 27/32	1600697	2700999	1100899	0300147	9047870	9073221	9128563
28	2872	31 7/8 x 86 27/32	1611068	2701001	1100901	0300148	9047871	9073222	9128564
	2876	31 7/8 x 90 27/32	1611069	2701002	1100902	0300149	9047872	9073223	9128565
210	21072	33 7/8 x 86 27/32	1600698	2701009	1100909	0300156	9047879	9073230	9128572
	21076	33 7/8 x 90 27/32	1600699	2701010	1100910	0300157	9047880	9073231	9128573
30	3072	35 7/8 x 86 27/32	1611072	2701003	1100903	0300150	9047873	9073224	9128566
	3076	35 7/8 x 90 27/32	1611073	2701004	1100904	0300151	9047874	9073525	9128567
34	3472	39 7/8 x 86 27/32	1611075	2701005	1100905	0300152	9047875	9073226	9128568
	3476	39 7/8 x 90 27/32	1611076	2701006	1100906	0300153	9047876	9073227	9128569
38	3872	43 7/8 x 86 27/32	1611078	2701007	1100907	0300154	9047877	9073228	9128570
	3876	43 7/8 x 90 27/32	1611079	2701008	1100908	0300155	9047878	9073229	9128571

Insect Screens

Insect Screens - Half / Even & Cottage / TruScene® (4/2007 - Present)

Note:
Half Insect Screens N/A.

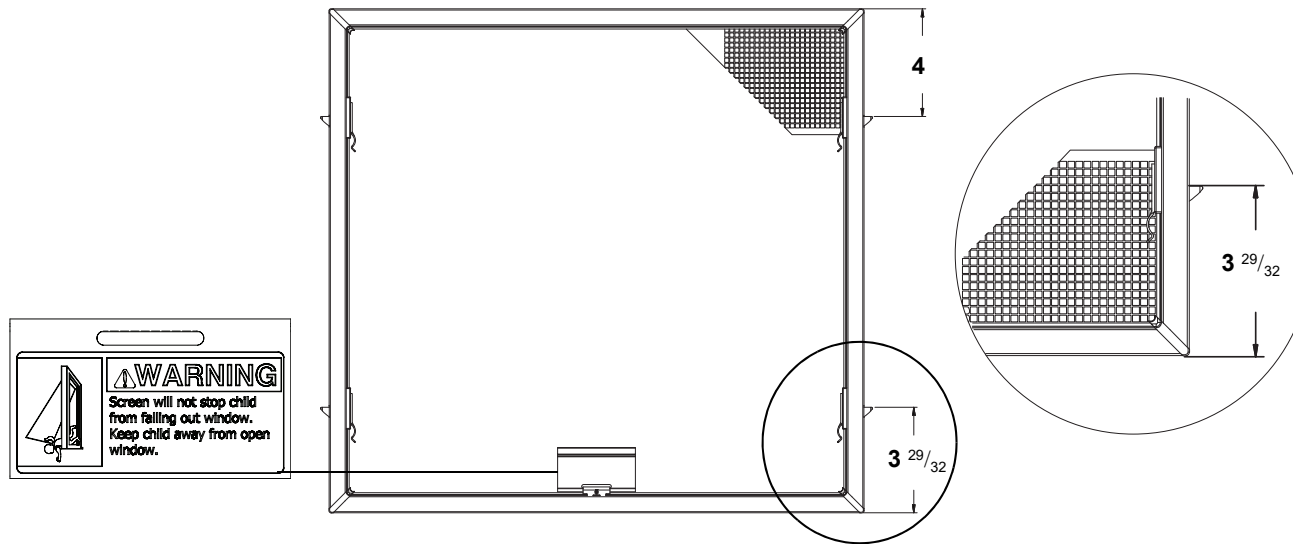

Tilt-Wash Monumental Half Insect Screen

400 Series Tilt-Wash Monumental Windows (2005 to Present)

Monumental Windows

Insect Screens

Insect Screen - Half / TruScene® (4/2007 - Present)

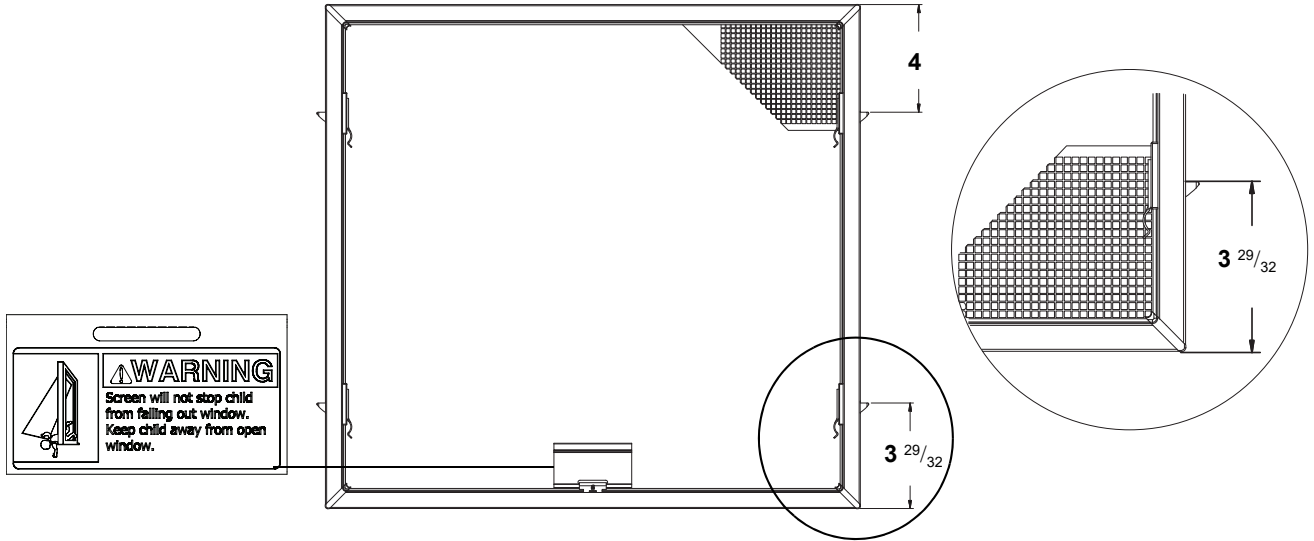

Tilt-Wash Monumental Half Insect Screen

Unit No.		Dimensions (w x h)	White	Terra-tone®	Sand-tone	Forest Green	Canvas	Dark Bronze	Black
18	1872E	19 7/8 x 44 7/8	N/A	N/A	N/A	N/A	N/A	N/A	N/A
	1876E	19 7/8 x 46 7/8	N/A	N/A	N/A	N/A	N/A	N/A	N/A
20	2072E	23 7/8 x 44 7/8	N/A	N/A	N/A	N/A	N/A	N/A	N/A
	2076E	23 7/8 x 46 7/8	N/A	N/A	N/A	N/A	N/A	N/A	N/A
24	2472E	27 7/8 x 44 7/8	N/A	N/A	N/A	N/A	N/A	N/A	N/A
	2476E	27 7/8 x 46 7/8	N/A	N/A	N/A	N/A	N/A	N/A	N/A
26	2672E	29 7/8 x 44 7/8	N/A	N/A	N/A	N/A	N/A	N/A	N/A
	2676E	29 7/8 x 46 7/8	N/A	N/A	N/A	N/A	N/A	N/A	N/A
28	2872E	31 7/8 x 44 7/8	N/A	N/A	N/A	N/A	N/A	N/A	N/A
	2876E	31 7/8 x 46 7/8	N/A	N/A	N/A	N/A	N/A	N/A	N/A
210	21072E	33 7/8 x 44 7/8	N/A	N/A	N/A	N/A	N/A	N/A	N/A
	21076E	33 7/8 x 46 7/8	N/A	N/A	N/A	N/A	N/A	N/A	N/A
30	3072E	35 7/8 x 44 7/8	N/A	N/A	N/A	N/A	N/A	N/A	N/A
	3076E	35 7/8 x 46 7/8	N/A	N/A	N/A	N/A	N/A	N/A	N/A
34	3472E	39 7/8 x 44 7/8	N/A	N/A	N/A	N/A	N/A	N/A	N/A
	3476E	39 7/8 x 46 7/8	N/A	N/A	N/A	N/A	N/A	N/A	N/A
38	3872E	43 7/8 x 44 7/8	N/A	N/A	N/A	N/A	N/A	N/A	N/A
	3876E	43 7/8 x 46 7/8	N/A	N/A	N/A	N/A	N/A	N/A	N/A

Insect Screens

Insect Screens - Half / Even / Standard Mesh (4/2007 - Present)

Note:
Half Insect Screens N/A.

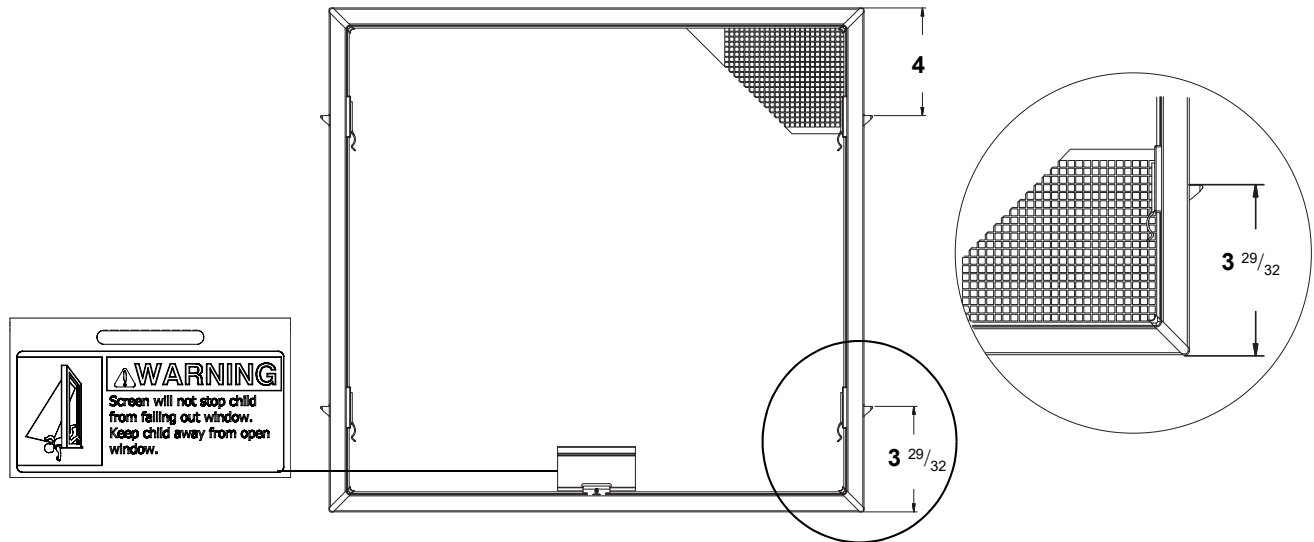

Tilt-Wash Monumental Half Insect Screen

400 Series Tilt-Wash Monumental Windows (2005 to Present)

Monumental Windows

Insect Screens

Insect Screen - Half / Standard Mesh (4/2007 - Present)

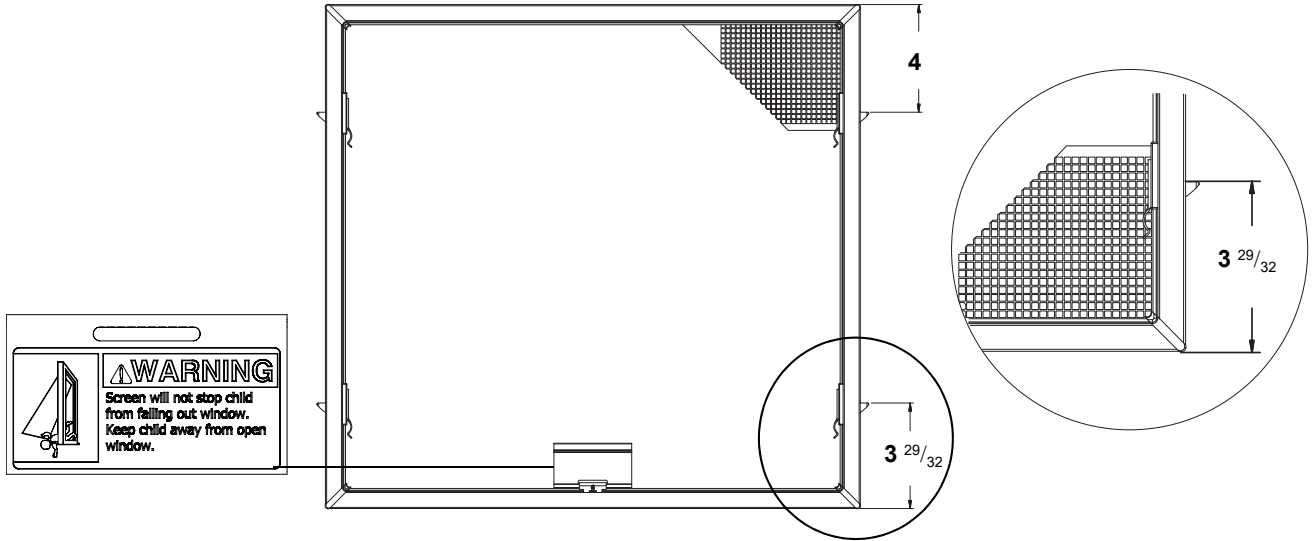

Tilt-Wash Monumental Half Insect Screen

Unit No.		Dimensions (w x h)	White	Terra-tone®	Sand-tone	Forest Green	Canvas	Dark Bronze	Black
18	1872E	19 7/8 x 44 7/8	N/A	N/A	N/A	N/A	N/A	N/A	N/A
	1876E	19 7/8 x 46 7/8	N/A	N/A	N/A	N/A	N/A	N/A	N/A
20	2072E	23 7/8 x 44 7/8	N/A	N/A	N/A	N/A	N/A	N/A	N/A
	2076E	23 7/8 x 46 7/8	N/A	N/A	N/A	N/A	N/A	N/A	N/A
24	2472E	27 7/8 x 44 7/8	N/A	N/A	N/A	N/A	N/A	N/A	N/A
	2476E	27 7/8 x 46 7/8	N/A	N/A	N/A	N/A	N/A	N/A	N/A
26	2672E	29 7/8 x 44 7/8	N/A	N/A	N/A	N/A	N/A	N/A	N/A
	2676E	29 7/8 x 46 7/8	N/A	N/A	N/A	N/A	N/A	N/A	N/A
28	2872E	31 7/8 x 44 7/8	N/A	N/A	N/A	N/A	N/A	N/A	N/A
	2876E	31 7/8 x 46 7/8	N/A	N/A	N/A	N/A	N/A	N/A	N/A
210	21072E	33 7/8 x 44 7/8	N/A	N/A	N/A	N/A	N/A	N/A	N/A
	21076E	33 7/8 x 46 7/8	N/A	N/A	N/A	N/A	N/A	N/A	N/A
30	3072E	35 7/8 x 44 7/8	N/A	N/A	N/A	N/A	N/A	N/A	N/A
	3076E	35 7/8 x 46 7/8	N/A	N/A	N/A	N/A	N/A	N/A	N/A
34	3472E	39 7/8 x 44 7/8	N/A	N/A	N/A	N/A	N/A	N/A	N/A
	3476E	39 7/8 x 46 7/8	N/A	N/A	N/A	N/A	N/A	N/A	N/A
38	3872E	43 7/8 x 44 7/8	N/A	N/A	N/A	N/A	N/A	N/A	N/A
	3876E	43 7/8 x 46 7/8	N/A	N/A	N/A	N/A	N/A	N/A	N/A

Frames

Frame Assembly Graphic

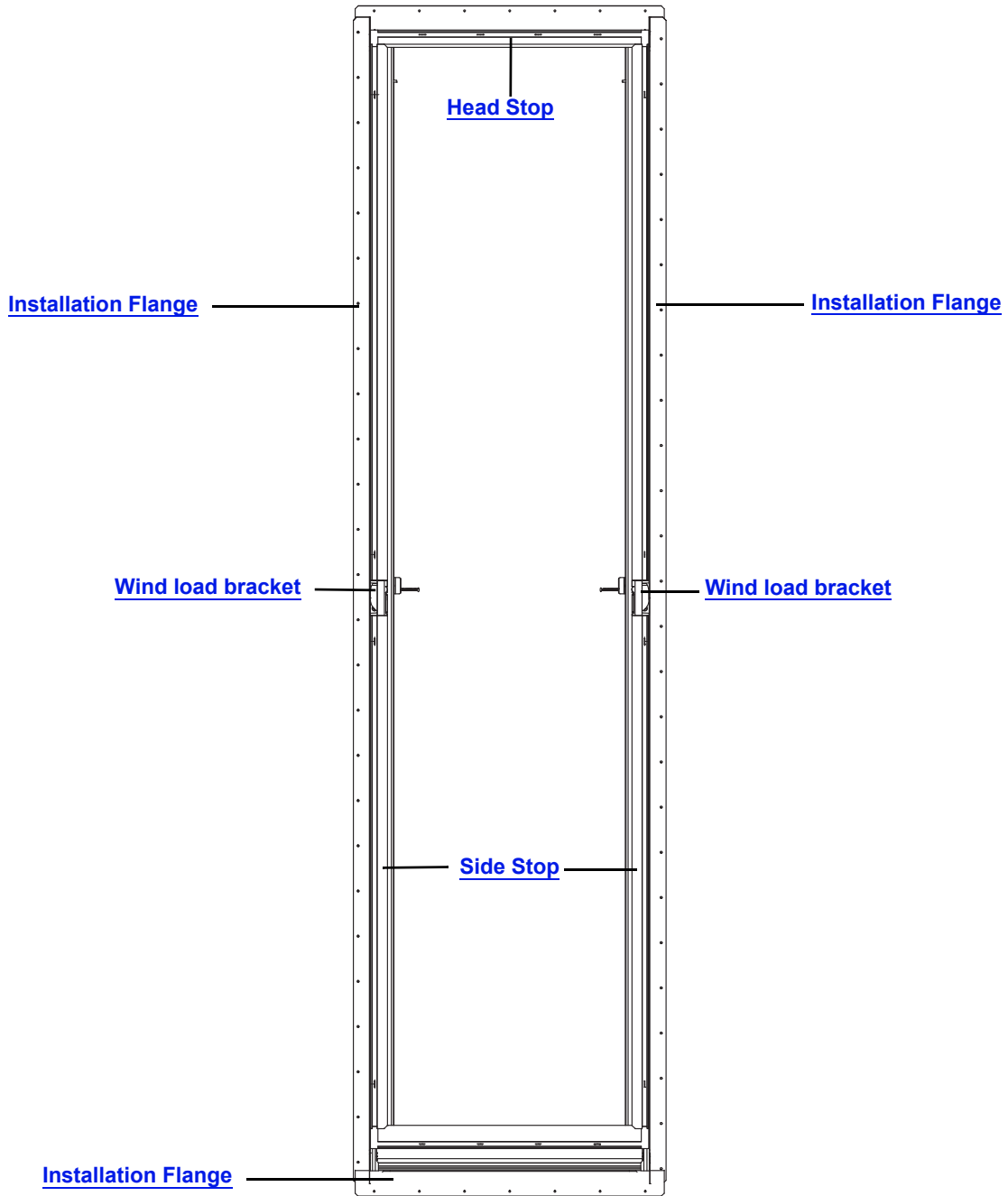

Tilt-Wash Monumental Frame Assembly

400 Series Tilt-Wash Monumental Windows (2005 to Present)

Monumental Windows

Frames

Frames

Note:

Service Replacement only.

To order, state:

Product ID (from product label, see [Service Guide 9051877](#))

OR

1. Unit size (400TW monumental size W x H dimensions)
2. Unit sash ratio (Even)
3. Description of part (Replacement Frame)
4. Manufacturing Date
5. Exterior color of frame
6. Interior finish of inside stops
7. Jamb liner color (white or grey)
8. Glass Type (required when ordering frame w/ balancers)

Stops (9/2017 - Present)

Note:

Head and sill stops use "standard" [400 TW stops](#).

Stop - Side / Upper Monumental Sizes (9/2017 - Present)

Unit No.	Length	Natural Wood	Prefinished Interior White	Natural Wood	Prefinished Interior White
		Upper Left		Upper Right	
TW72	41 1/2	OBD/Configured	OBD/Configured	OBD/Configured	OBD/Configured
TW76	43 1/2	OBD/Configured	OBD/Configured	OBD/Configured	OBD/Configured

Stop - Side / Lower Monumental Sizes (9/2017 - Present)

Unit No.	Length	Natural Wood	Prefinished Interior White	Natural Wood	Prefinished Interior White
		Lower Left		Lower Right	
TW72	39 3/4	OBD/Configured	OBD/Configured	OBD/Configured	OBD/Configured
TW76	41 3/4	OBD/Configured	OBD/Configured	OBD/Configured	OBD/Configured

Stop - Side / Upper Monumental Sizes (2005 - 8/2017)

Unit No.	Length	Natural Wood	Prefinished Interior White	Natural Wood	Prefinished Interior White
		Upper Left		Upper Right	
TW72	41 1/4	9046276	OBD/Configured	9046277	OBD/Configured
TW76	43 1/4	9046280	OBD/Configured	9046281	OBD/Configured

Stop - Side / Lower Monumental Sizes (2005 - 8/2017)

Unit No.	Length	Natural Wood	Prefinished Interior White	Natural Wood	Prefinished Interior White
		Lower Left		Lower Right	
TW72	39 15/16	9046278	OBD/Configured	9046279	OBD/Configured
TW76	41 15/16	9046282	OBD/Configured	9046283	OBD/Configured

Frames

Extension Jamb / Wood / Lineal									
Extension Jamb / Wood / Lineal									
Wall Depth	Dim A	Pine		Oak		Maple			
		96"	144"	96"	144"	96"	144"		
5"	5	15/32	N/A	N/A	N/A	N/A	N/A	N/A	
	5 1/16	17/32	9104431	9104427	9104433	9104429	9104434		
	5 1/8	19/32	9104439	9104435	9104441	9104437	9104442		
	5 3/16	21/32	9104447	9104443	9104449	9104445	9104450		
	5 1/4	23/32	1636627	1636628	9104419	9104416	9104420	9104417	
	5 5/16	25/32	9104455	9104451	9104457	9104453	9104458		
	5 3/8	27/32	9104463	9104459	9104465	9104461	9104466		
	5 7/16	29/32	9104471	9104467	9104473	9104469	9104474		
	5 1/2	31/32	9104479	9104475	9104481	9104477	9104482		
	5 9/16	1 1/32	9104487	9104483	9104489	9104485	9104490		
	5 5/8	1 3/32	9104495	9104491	9104497	9104493	9104498		
	5 11/16	1 5/32	9104503	9104499	9104505	9104501	9104506		
	5 3/4	1 7/32	9104511	9104507	9104513	9104509	9104514		
	5 13/16	1 9/32	9104519	9104515	9104521	9104517	9104522		
	5 7/8	1 11/32	9104527	9104523	9104529	9104525	9104530		
5 15/16	1 13/32	9104535	9104531	9104537	9104533	9104538			
6"	6	1 15/32	9104543	9104539	9104545	9104541	9104546		
	6 1/16	1 17/32	9104551	9104547	9104553	9104549	By description		
	6 1/8	1 19/32	9104559	9104555	9104561	9104557	9104562		
	6 3/16	1 21/32	9104467	9104563	9104569	9104565	9104570		
	6 1/4	1 23/32	9104575	9104571	9104577	9104573	9104578		
	6 5/16	1 25/32	9104583	9104579	9104585	9104581	9104586		
	6 3/8	1 27/32	9104591	9104587	9104593	9104589	9104594		
	6 7/16	1 29/32	9104599	9104595	9104601	9104597	9104602		
	6 1/2	1 31/32	9104607	9104603	9104609	9104605	9104610		
	6 9/16	2 1/32	1636637	1636638	9104413	9104411	9104414	9104412	
	6 5/8	2 3/32	9104615	9104611	9104617	9104613	9104618		
	6 11/16	2 5/32	9104623	9104619	9104625	9104621	9104626		
	6 3/4	2 7/32	9104631	9104627	9104633	9104629	9104634		
	6 13/16	2 9/32	9104639	9104635	9104641	9104637	9104642		
	6 7/8	2 11/32	9104647	9104643	9104649	9104645	9104650		
6 15/16	2 13/32	9104655	9104651	9104657	9104653	9104658			
7"	7	2 15/32	9104663	9104659	9104665	9104661	9104666		
	7 1/16	2 17/32	9104671	9104667	9104673	9104669	9104674		
	7 1/8	2 19/32	1636647	1636648	9104425	9104422	9104426	9104423	

400 Series Tilt-Wash Monumental Windows (2005 to Present)

Monumental Windows

Frames

Extension Jamb / Painted / Lineal												
Extension Jamb / Painted / Lineal												
Wall Depth	Dim A	White Painted		White Vinyl Wrapped		Dark Bronze Painted		Black Painted		Sandtone Painted		
		96"	144"	96"	144"	96"	144"	96"	144"	96"	144"	
5"	5	15/32	N/A	N/A	N/A	N/A	N/A	N/A	N/A	N/A	N/A	N/A
	5 1/16	17/32	By description	By description	N/A	N/A	9145388	9145387	9144790	9144789	N/A	N/A
	5 1/8	19/32	By description	By description	N/A	N/A	9145390	9145389	9144792	9144791	N/A	N/A
	5 3/16	21/32	By description	By description	N/A	N/A	9145392	9145391	9144794	9144793	N/A	N/A
	5 1/4	23/32	1694669	1694670	N/A	N/A	9145384	9145383	9144786	9144785	N/A	N/A
	5 5/16	25/32	By description	By description	N/A	N/A	9145394	9145393	9144796	9144795	N/A	N/A
	5 3/8	27/32	By description	By description	N/A	N/A	9145396	9145395	9144798	9144797	N/A	N/A
	5 7/16	29/32	By description	By description	N/A	N/A	9145398	9145397	9144800	9144799	N/A	N/A
	5 1/2	31/32	By description	By description	N/A	N/A	9145400	9145399	9144802	9144801	N/A	N/A
	5 9/16	1 1/32	By description	By description	N/A	N/A	9145402	9145401	9144804	9144803	N/A	N/A
	5 5/8	1 3/32	By description	By description	N/A	N/A	9145404	9145403	9144806	9144805	N/A	N/A
	5 11/16	1 5/32	By description	By description	N/A	N/A	9145406	9145405	9144808	9144807	N/A	N/A
	5 3/4	1 7/32	By description	By description	N/A	N/A	9145408	9145407	9144810	9144809	N/A	N/A
	5 13/16	1 9/32	By description	By description	N/A	N/A	9145410	9145409	9144812	9144811	N/A	N/A
	5 7/8	1 11/32	By description	By description	N/A	N/A	9145412	9145411	9144814	9144813	N/A	N/A
5 15/16	1 13/32	By description	By description	N/A	N/A	9145414	9145413	9144816	9144815	N/A	N/A	
6"	6	1 15/32	By description	By description	N/A	N/A	9145416	9145415	9144818	9144817	N/A	N/A
	6 1/16	1 17/32	By description	By description	N/A	N/A	9145418	9145417	9144820	9144819	N/A	N/A
	6 1/8	1 19/32	By description	By description	N/A	N/A	9145420	9145419	9144822	9144821	N/A	N/A
	6 3/16	1 21/32	By description	By description	N/A	N/A	9145422	9145421	9144824	9144823	N/A	N/A
	6 1/4	1 23/32	By description	By description	N/A	N/A	9145424	9145423	9144826	9144825	N/A	N/A
	6 5/16	1 25/32	By description	By description	N/A	N/A	9145426	9145425	9144828	9144827	N/A	N/A
	6 3/8	1 27/32	By description	By description	N/A	N/A	9145428	9145427	9144830	9144829	N/A	N/A
	6 7/16	1 29/32	By description	By description	N/A	N/A	9145430	9145429	9144832	9144831	N/A	N/A
	6 1/2	1 31/32	By description	By description	N/A	N/A	9145432	9145431	9144834	9144833	N/A	N/A
	6 9/16	2 1/32	1694628	1694629	N/A	N/A	9146080	9146081	9146066	9146067	9164689	9164682
	6 5/8	2 3/32	By description	By description	N/A	N/A	9145434	9145433	9144836	9144835	N/A	N/A
	6 11/16	2 5/32	By description	By description	N/A	N/A	9145436	9145435	9144838	9144837	N/A	N/A
	6 3/4	2 7/32	By description	By description	N/A	N/A	9145438	9145437	9144840	9144839	N/A	N/A
	6 13/16	2 9/32	By description	By description	N/A	N/A	9145440	9145439	9144842	9144841	N/A	N/A
	6 7/8	2 11/32	By description	By description	N/A	N/A	9145442	9145441	9144844	9144843	N/A	N/A
6 15/16	2 13/32	By description	By description	N/A	N/A	9145444	9145443	9144846	9144845	N/A	N/A	
7"	7	2 15/32	By description	By description	N/A	N/A	9145446	9145445	9144848	9144847	N/A	N/A
	7 1/16	2 17/32	By description	By description	N/A	N/A	9145448	9145447	9144850	9144849	N/A	N/A
	7 1/8	2 19/32	1694711	1694712	N/A	N/A	9145386	9145385	9144788	9144787	N/A	N/A

Frames

Jamb Liners

Jamb Liner - Side

Note:

Head jamb liner uses "standard" **400 TW head** liners. Handing for side jamb liners is determined based on the exterior view of the unit. Jamb liner includes balancer covers, chimney plug, head/sill plugs, wash assist, wash assist stop and weatherstrip.

Unit No.	Length	White		Gray	
		Left	Right	Left	Right
TW72	86 ³ / ₃₂	OBD	OBD	OBD	OBD
TW76	90 ³ / ₃₂	OBD	OBD	OBD	OBD

Wash Assist

		Gray
		1643027

Stop - Wash Assist

		Color	Order No.
		Gray	1643028

Balancer Cover

Cover - Balancer

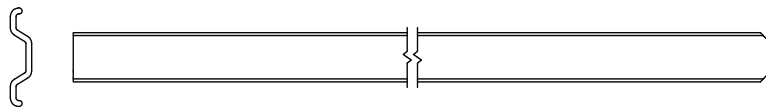

Unit No.	Length	White	Gray
TW72	41 ⁷ / ₈	1650061	2700134
TW76	43 ⁷ / ₈	1650062	2700135

Balancer Cover Tables (6/2017 - Present)

Note:

Upper balancer cover is 2" shorter than lower balancer cover.

Cover - Balancer / Even (6/2017 - Present)

	Unit No.	White		Gray		
			Upper	Lower	Upper	Lower
		TW72	9170290	1650061	9170291	2700134
		TW76	1650061	1650062	2700134	2700135

400 Series Tilt-Wash Monumental Windows (2005 to Present)

Monumental Windows

Frames

Flange			
Nailing Flange - Side (Pair)			
	Unit No.	Length	Order No.
	TW72	90 ²¹ / ₆₄	1635037
	TW76	94 ²¹ / ₆₄	1635038

Frames

Frame Hardware

Note:

Colors not shown available by description.

Screw - Bracket / Outer Frame Member Bracket

Description	White	Terra-tone®	Sandtone	Forest Green	Canvas	Dark Bronze
#8-15 x 1-1/4 Typ A PH FL 18-8 SS	3629085	3629087	3629086	3629088	9072073	9073802
#8-15 x 3 Typ A PH FL 18-8 SS	3629089	3629091	3629090	3629092	9072072	9073803
	Black					
#8-15 x 1-1/4 Typ A PH FL 18-8 SS	9129190					
#8-15 x 3 Typ A PH FL 18-8 SS	9129191					

Bracket - Frame Tie (4/2007 - Present)

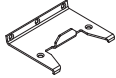
	Order No.
	1690604

Bracket with Screws - Outer Frame Member

	Note: Used to replace previous vintages.	Color	Order No.
		White	1630139
		Terratone®	2743023
		Sandtone	1166002
		Forest Green	0375102
		Black	9133908
		Dark Bronze	9133909
	Canvas	9133910	

Bracket - Wind Load Kit (4/2007 - Present)

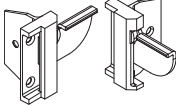
	Kit includes: 1 right hand and 1 left hand wind load bracket.	Dimensions	Color	Order No.
		1 11/32 x 2 23/32	Stone	2743028
			White	1690670