

What's in This Section

Standard Windows	Page 3
Parts Illustration	3
Unit Sizes	4
Standard and Custom Window Sizes	4
400 Series Product Label	4
Unit Size Chart - Woodwright® Double Hung Windows	5
Unit Size Chart - Woodwright® Springline™ Single-Hung Windows	6
Unit Size Chart - Woodwright® Arch Double-Hung Windows	7
Unit Size Chart - Woodwright® Unequal Leg Arch Double-Hung Windows	8
Product History	9
Product History	9
Sash	10
Sash Size Table	10
Sash-Upper	12
Sash-Lower	13
Weatherstrip	14
Sash Hardware - Lifts	15
Sash Hardware - Lock Kits/Components	18
Shim Kits/Components	19
Sash Hardware - Latch Kits	20
Sash Components - Miscellaneous	20
Sash Hardware - Opening Control Device	21
Sash Balancers	22
Sash Balancers (<i>October 2006 - present</i>)	22
Vintage Sash Balancers (<i>2002 - October 2006</i>)	25
Sash Balancer Hardware	36
Insect Screens	38
Insect Screens - Full / TruScene®	38
Insect Screens - Full / Standard	44
Insect Screens - Half / Standard	49
Bug Seal - Insect Screen - Half	49
Insect Screen Hardware	50
Grilles	51
Interior Grilles	51
Interior Grille Parts	51
Combination Unit	52
Combination Unit - Double Hung	52

Frames	53
Frame Assembly	53
Frames	54
Stools	55
Inside Stops	56
Extension Jambs	57
Flange	58
Weatherstrip	59
Misc Frame Parts	60
Installation Kit	61
Joining Components	62
Narrow Mullion Kits	62
Narrow Mullion Kit Components	63
Support Mullion Kits	64
Support Mullion Kit Components	64
Reinforced Steel Mullion Illustration	65
Reinforced Steel Mull Joining Components	65
Universal Drip Cap - Continuous	68
 Angle Bay Windows	 Page 69
Unit Sizes	69
Unit Sizes - Double-Hung Angle Bay	69
Unit Sizes - Double-Hung / Picture Windows Angle Bay	73
 Service Replacement	 Page 75
Service Replacement Only	75
Service Replacement Only Parts	75
Weatherstrip	75
Exterior Grilles - HDN	76
Service Materials	76
Jamb Liners	76

400 Series Woodwright® Double-Hung Windows (2002 to Present)

Standard Windows

Parts Illustration

Parts Illustration

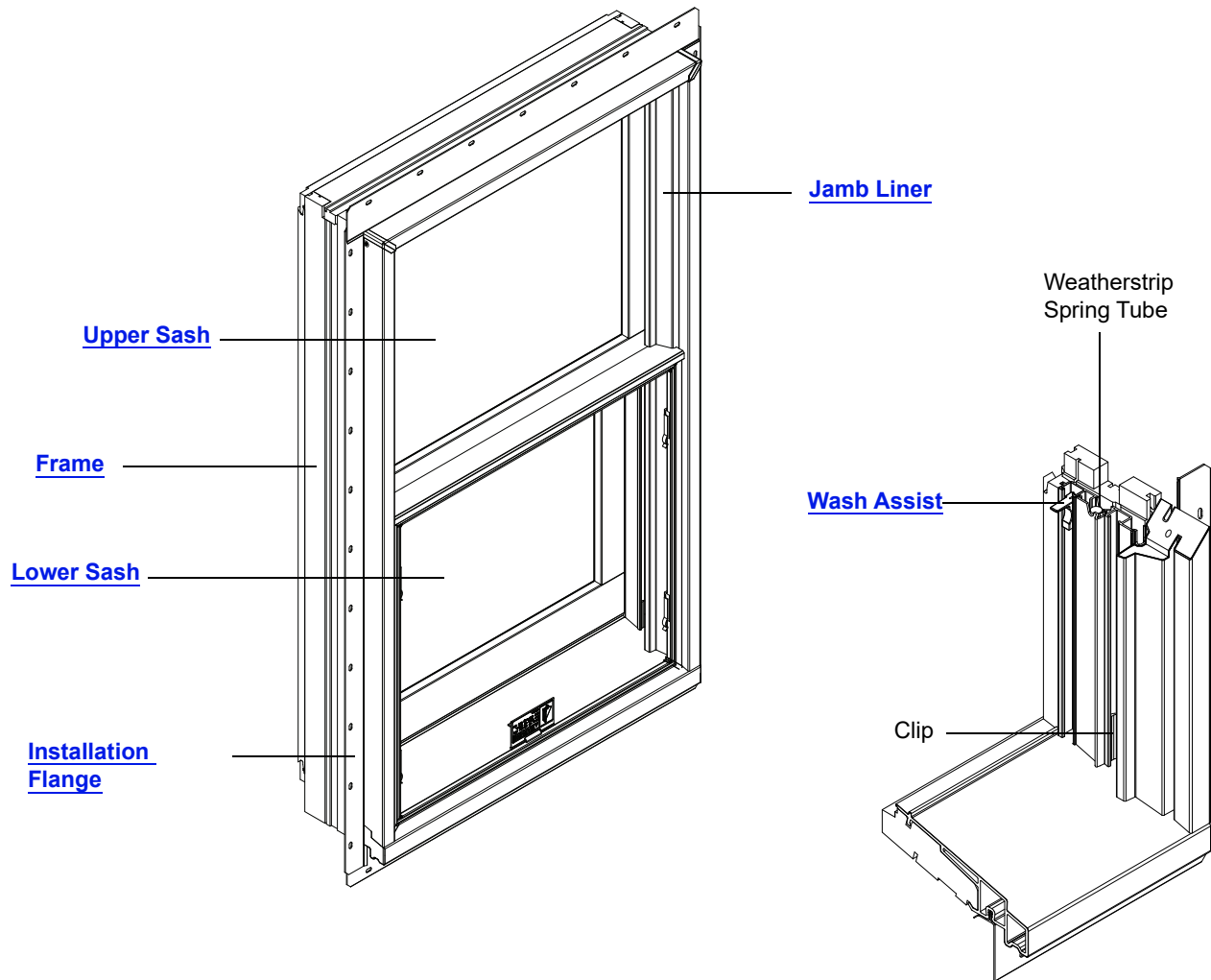

Manufactured 2002 to Present

Woodwright® Double-Hung Window Unit Parts

Unit viewed from exterior.

Unit Sizes

Standard and Custom Window Sizes

Note:

Woodwright Windows are available in standard sizes (see standard size charts, [page 5](#)). Replacement parts for some standard windows can be ordered using the numbers listed in this catalog. Many replacement parts for standard windows are made to order. These items are ordered using the Product ID found on the identification label and a description of the part needed. See [Service Guide 9051877](#).

Woodwright Windows are also available in custom sizes in 1/8" increments between the smallest and the largest standard sizes. Most replacement parts for custom-sized windows are made to order and can be ordered with the Product ID found on the identification label and a description of the part needed. See [Service Guide 9051877](#).

400 Series Product Label

Note:

Every Woodwright Window will have an identification label or glass etching containing a unique Product ID. The Product ID on Woodwright Windows will be located at the top of the window frame or etched into the glass. See [Service Guide 9051877](#). The Product ID may be up to 14 digits long (excluding hyphens), depending on the age of the unit. Replacement parts will also get their own unique Product ID. When ordering replacement parts, providing the Product ID ensures that replacement parts match the specifications.

Pre-2009 Label

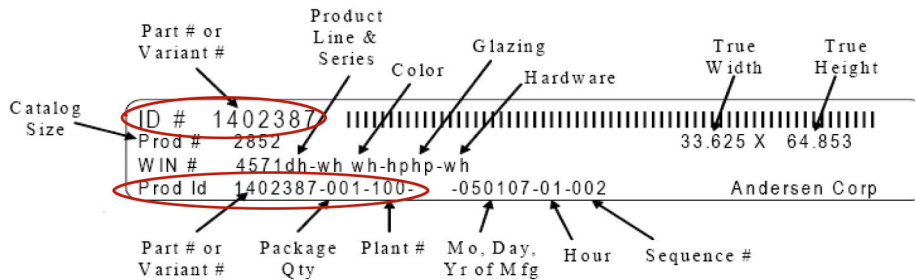

2009 to Present



P Number



PXXXXXXIXX
DCA, LSC
16 CFR 1201 CM

CIG-X ANSIZ97.1 1994
SGCC XXXX U XXXX Q-YR

Quarter and Year of Manufacture

400 Series Woodwright® Double-Hung Windows (2002 to Present)

Standard Windows

Unit Sizes

Unit Size Chart - Woodwright® Double Hung Windows

Note:

Unit Dimension refers to overall outside-to-outside frame. Unobstructed Glass refers to visible glass dimensions.

See [Measuring Visible Glass Video](#).

Custom sizing between 16-1/2" and 45-5/8" – in 1/8" increments.

Unit Dimension	1'-9 5/8"	2'-1 5/8"	2'-5 5/8"	2'-7 5/8"	2'-9 5/8"	2'-11 5/8"	3'-1 5/8"	3'-5 5/8"	3'-9 5/8"	
	(549)	(651)	(752)	(803)	(854)	(905)	(956)	(1057)	(1159)	
Minimum Rough Opening	1'-10 1/8"	2'-2 1/8"	2'-6 1/8"	2'-8 1/8"	2'-10 1/8"	3'-0 1/8"	3'-2 1/8"	3'-6 1/8"	3'-10 1/8"	
	(562)	(664)	(765)	(816)	(867)	(917)	(968)	(1070)	(1172)	
Unobstructed Glass*	15 5/8"	19 5/8"	23 5/8"	25 5/8"	27 5/8"	29 5/8"	31 5/8"	35 5/8"	39 5/8"	
	(397)	(498)	(600)	(651)	(702)	(752)	(803)	(905)	(1006)	
	3'-0 7/8"									
	(937)									
	3'-0 7/8"									
	(937)									
	13 3/8"									
	(340)									
	WDH18210	WDH20210	WDH24210	WDH26210	WDH28210	WDH210210	WDH30210	WDH34210	WDH38210	
	3'-4 7/8"									
	(1038)									
	3'-4 7/8"									
	(1038)									
	15 3/8"									
	(391)									
	WDH1832	WDH2032	WDH2432	WDH2632	WDH2832	WDH21032	WDH3032	WDH3432	WDH3832	
	3'-8 7/8"									
	(1140)									
	3'-8 7/8"									
	(1140)									
	17 3/8"									
	(441)									
	WDH1836	WDH2036	WDH2436	WDH2636	WDH2836	WDH21036	WDH3036	WDH3436	WDH3836	
	4'-0 7/8"									
	(1241)									
	4'-0 7/8"									
	(1241)									
	19 3/8"									
	(492)									
	WDH18310	WDH20310	WDH24310	WDH26310	WDH28310	WDH210310	WDH30310	WDH34310	WDH38310	
	4'-4 7/8"									
	(1343)									
	4'-4 7/8"									
	(1343)									
	21 3/8"									
	(543)									
	WDH1842	WDH2042	WDH2442	WDH2642	WDH2842	WDH21042	WDH3042	WDH3442	WDH3842	
	4'-8 7/8"									
	(1445)									
	4'-8 7/8"									
	(1445)									
	23 3/8"									
	(594)									
	WDH1846	WDH2046	WDH2446	WDH2646	WDH2846	WDH21046	WDH3046	WDH3446	WDH3846	
	5'-0 7/8"									
	(1546)									
	5'-0 7/8"									
	(1546)									
	25 3/8"									
	(645)									
	WDH18410	WDH20410	WDH24410	WDH26410	WDH28410	WDH210410	WDH30410	WDH34410	WDH38410	
	5'-4 7/8"									
	(1648)									
	5'-4 7/8"									
	(1648)									
	27 3/8"									
	(695)									
	WDH1852	WDH2052	WDH2452	WDH2652	WDH2852	WDH21052	WDH3052	WDH3452	WDH3852	
	5'-8 7/8"									
	(1749)									
	5'-8 7/8"									
	(1749)									
	29 3/8"									
	(746)									
	WDH1856	WDH2056	WDH2456	WDH2656	WDH2856	WDH21056	WDH3056	WDH3456	WDH3856	
	6'-0 7/8"									
	(1851)									
	6'-0 7/8"									
	(1851)									
	31 3/8"									
	(797)									
	WDH18510	WDH20510	WDH24510	WDH26510	WDH28510	WDH210510	WDH30510	WDH34510	WDH38510	
	6'-4 7/8"									
	(1953)									
	6'-4 7/8"									
	(1953)									
	33 3/8"									
	(848)									
	WDH1862	WDH2062	WDH2462	WDH2662	WDH2862	WDH21062	WDH3062	WDH3462	WDH3862	

Custom sizing between 32" and 76-7/8" – in 1/8" increments (equal sash).

Custom sizing between 36-7/8" and 65-1/2" – in 1/8" increments.

Woodwright® Double-Hung Window Unit Sizes

Unit Sizes

Unit Size Chart - Woodwright® Springline™ Single-Hung Windows

Note:

Unit Dimension refers to overall outside-to-outside frame. Unobstructed Glass refers to visible glass dimensions.

See [Measuring Visible Glass Video](#).

Window Dimension	2'-1 5/8"	2'-5 5/8"	2'-7 5/8"	2'-9 5/8"	2'-11 5/8"	3'-1 5/8"	3'-5 5/8"	3'-9 5/8"
Minimum	(651)	(752)	(803)	(854)	(905)	(956)	(1057)	(1159)
Rough Opening	2'-2 1/8"	2'-6 1/8"	2'-8 1/8"	2'-10 1/8"	3'-0 1/8"	3'-2 1/8"	3'-6 1/8"	3'-10 1/8"
Unobstructed Glass (lower sash only)	19 5/8"	23 5/8"	25 5/8"	27 5/8"	29 5/8"	31 5/8"	35 5/8"	39 5/8"
	(498)	(600)	(651)	(702)	(752)	(803)	(905)	(1006)

CUSTOM WIDTHS - 2'-1 5/8" to 3'-9 5/8"	
Unobstructed Glass (lower sash only)	Shoulder Height
12 13/16" (325)	14 13/16" (376)
14 13/16" (376)	15 13/16" (402)
15 13/16" (402)	16 13/16" (427)
16 13/16" (427)	17 13/16" (452)
17 13/16" (452)	18 13/16" (478)
18 13/16" (478)	20 13/16" (529)
20 13/16" (529)	22 13/16" (579)

CUSTOM HEIGHTS - 4'-4 13/16" to 6'-4 1/2"	
Unobstructed Glass (lower sash only)	Shoulder Height
21 3/8" (543)	3'-4" (1016)
23 3/8" (594)	3'-7" (1092)
25 3/8" (645)	3'-10" (1168)
27 3/8" (695)	4'-1" (1244)
29 3/8" (746)	4'-8" (1448)
31 3/8" (797)	5'-0 1/2" (1524)
33 3/8" (848)	5'-3 1/2" (1600)

Unobstructed Glass (lower sash only)	Shoulder Height	Radius and Chord Height
21 3/8" (543)	3'-4" (1016)	4'-1 13/16" (1341)
23 3/8" (594)	3'-7" (1092)	4'-6 5/16" (1392)
25 3/8" (645)	3'-10" (1168)	4'-7 13/16" (1418)
27 3/8" (695)	4'-1" (1244)	4'-8 3/16" (1443)
29 3/8" (746)	4'-8" (1448)	4'-9 13/16" (1468)
31 3/8" (797)	5'-0 1/2" (1524)	4'-10 13/16" (1494)
33 3/8" (848)	5'-3 1/2" (1600)	5'-0 13/16" (1545)
		5'-2 13/16" (1595)
		4'-7 13/16" (1418)
		4'-9 13/16" (1468)
		4'-10 13/16" (1494)
		4'-11 13/16" (1519)
		5'-0 13/16" (1545)
		5'-1 13/16" (1570)
		5'-2 13/16" (1595)
		5'-3 13/16" (1621)
		5'-4 13/16" (1646)
		5'-5 13/16" (1672)
		5'-6 13/16" (1697)
		5'-7 13/16" (1722)
		5'-8 13/16" (1748)
		5'-9 13/16" (1773)
		5'-10 13/16" (1799)
		5'-11 13/16" (1824)
		5'-12 13/16" (1850)
		5'-1 13/16" (1875)
		5'-2 13/16" (1901)
		5'-3 13/16" (1926)
		5'-4 13/16" (1952)
		5'-5 13/16" (1977)
		5'-6 13/16" (2002)
		5'-7 13/16" (2028)
		5'-8 13/16" (2053)
		5'-9 13/16" (2079)
		5'-10 13/16" (2104)
		5'-11 13/16" (2130)
		5'-12 13/16" (2155)
		6'-0 13/16" (2181)
		6'-1 13/16" (2206)
		6'-2 13/16" (2232)
		6'-3 13/16" (2257)
		6'-4 13/16" (2283)
		6'-5 13/16" (2308)
		6'-6 13/16" (2334)
		6'-7 13/16" (2359)
		6'-8 13/16" (2385)
		6'-9 13/16" (2410)
		6'-10 13/16" (2436)
		6'-11 13/16" (2461)
		6'-12 13/16" (2487)



Custom-size windows are available in 1/8" (3) increments.

Rough opening height is the same as the window dimension height. Upper sash does not operate and lower sash travel is limited by the radius of the upper sash. Contact your Andersen supplier for cottage and reverse cottage sash availability. Side-by-side joining is not recommended.

Woodwright® Springline Single-Hung Window Unit Sizes

400 Series Woodwright® Double-Hung Windows (2002 to Present)

Standard Windows

Unit Sizes

Unit Size Chart - Woodwright® Arch Double-Hung Windows

Note:

Unit Dimension refers to overall outside-to-outside frame. Unobstructed Glass refers to visible glass dimensions.

See [Measuring Visible Glass Video](#).

Window Dimension	1'-9 5/8"	2'-1 1/8"	2'-5 5/8"	2'-7 5/8"	2'-9 5/8"	2'-11 5/8"	3'-1 5/8"	3'-5 5/8"	3'-9 5/8"
Minimum Rough Opening	1'-10 1/8"	2'-2 1/8"	2'-6 1/8"	2'-8 1/8"	2'-10 1/8"	3'-0 1/8"	3'-2 1/8"	3'-6 1/8"	3'-10 1/8"
Unobstructed Glass (lower sash only)	15 5/8"	19 5/8"	23 5/8"	25 5/8"	27 5/8"	29 5/8"	31 5/8"	35 5/8"	39 5/8"

CUSTOM WIDTHS - 1'-9 5/8" to 3'-9 5/8"		Radius	Chord Height	Shoulder Height
21 5/8" (549)	25 5/8" (651)	29 5/8" (752)	31 5/8" (803)	33 5/8" (854)
35 5/8" (905)	37 5/8" (956)	41 5/8" (1057)	45 5/8" (1159)	

CUSTOM HEIGHTS - 3'-0 7/8" to 6'-4 7/8"	Radius	Chord Height	Shoulder Height
3'-0 7/8" (937)	21 5/8" (549)	2 15/16" (75)	2'-9 15/16" (862)
3'-4 7/8" (1038)	25 5/8" (651)	3 7/8" (87)	3'-1 15/16" (964)
3'-8 7/8" (1140)	29 5/8" (752)	4" (102)	3'-5 15/16" (1065)
4'-0 7/8" (1241)	31 5/8" (803)	4 1/2" (108)	3'-9 15/16" (1167)
4'-4 7/8" (1343)	33 5/8" (854)	4 13/16" (122)	4'-1 15/16" (1268)
4'-8 7/8" (1445)	35 5/8" (905)	5 1/4" (129)	4'-5 15/16" (1370)
5'-0 7/8" (1546)	37 5/8" (956)	5 9/16" (141)	4'-9 15/16" (1472)
5'-4 7/8" (1648)	41 5/8" (1057)	6 1/2" (156)	5'-1 15/16" (1573)
5'-8 7/8" (1749)	45 5/8" (1159)		5'-5 15/16" (1675)
6'-0 7/8" (1851)			5'-9 15/16" (1776)
6'-4 7/8" (1953)			6'-1 15/16" (1878)

Unit Code	Unit Code	Unit Code	Unit Code	Unit Code	Unit Code	Unit Code	Unit Code	Unit Code	Unit Code
WA1862	WA2062	WA2462	WA2662	WA2862	WA21062	WA3062	WA3462	WA3862	
WA1850	WA2050	WA2450	WA2650	WA2850	WA21050	WA3050	WA3450	WA3850	
WA1856	WA2056	WA2456	WA2656	WA2856	WA21056	WA3056	WA3456	WA3856	
WA1852	WA2052	WA2452	WA2652	WA2852	WA21052	WA3052	WA3452	WA3852	
WA1840	WA2040	WA2440	WA2640	WA2840	WA21040	WA3040	WA3440	WA3840	
WA1846	WA2046	WA2446	WA2646	WA2846	WA21046	WA3046	WA3446	WA3846	
WA1842	WA2042	WA2442	WA2642	WA2842	WA21042	WA3042	WA3442	WA3842	
WA1830	WA2030	WA2430	WA2630	WA2830	WA21030	WA3030	WA3430	WA3830	
WA1836	WA2036	WA2436	WA2636	WA2836	WA21036	WA3036	WA3436	WA3836	
WA1832	WA2032	WA2432	WA2632	WA2832	WA21032	WA3032	WA3432	WA3832	
WA1820	WA2020	WA2420	WA2620	WA2820	WA21020	WA3020	WA3420	WA3820	
WA1826	WA2026	WA2426	WA2626	WA2826	WA21026	WA3026	WA3426	WA3826	
WA1822	WA2022	WA2422	WA2622	WA2822	WA21022	WA3022	WA3422	WA3822	
WA1810	WA2010	WA2410	WA2610	WA2810	WA21010	WA3010	WA3410	WA3810	
WA1816	WA2016	WA2416	WA2616	WA2816	WA21016	WA3016	WA3416	WA3816	
WA1812	WA2012	WA2412	WA2612	WA2812	WA21012	WA3012	WA3412	WA3812	
WA1800	WA2000	WA2400	WA2600	WA2800	WA21000	WA3000	WA3400	WA3800	
WA1806	WA2006	WA2406	WA2606	WA2806	WA21006	WA3006	WA3406	WA3806	
WA1802	WA2002	WA2402	WA2602	WA2802	WA21002	WA3002	WA3402	WA3802	

Custom-size windows are available in 1/8" (3) increments.

Lower sash travel is limited by the radius of the upper sash. Contact your Andersen supplier for cottage and reverse cottage sash availability.

Unequal leg arch and arch combination.

Side-by-side joining of arch windows is not recommended.

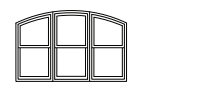

Woodwright® Arch Double-Hung Window Unit Sizes

Unit Sizes

Unit Size Chart - Woodwright® Unequal Leg Arch Double-Hung Windows

Note:

Unit Dimension refers to overall outside-to-outside frame. Unobstructed Glass refers to visible glass dimensions.

See [Measuring Visible Glass Video](#).

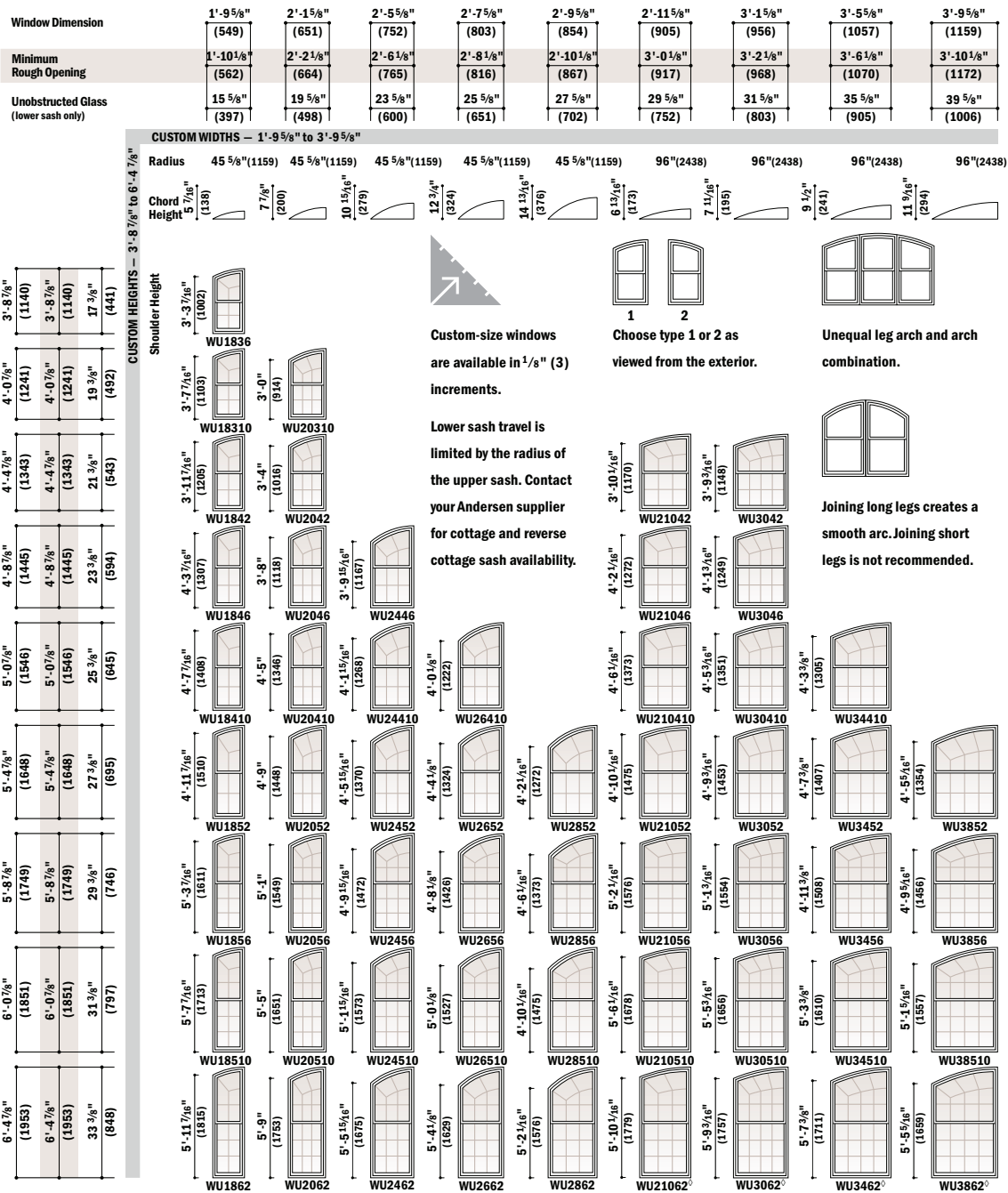

Woodwright® Unequal Leg Arch Double-Hung Window Unit Sizes

400 Series Woodwright® Double-Hung Windows (2002 to Present)

Standard Windows

Product History

Product History

- 2017** Lock/Keeper and Tilt-Latch redesign in March 2017.
- 2008** SmartSun™ glass introduced.
- 2007** Expanded size grid for cottage and reverse-cottage size windows.
- 2007** Factory-applied 6 9/16" extension jambs introduced.

Sash

Sash Size Table

Sash Size Table			
Unit No.	Unobstructed Glass	Unit No.	Unobstructed Glass
WDH18210	15 ⁵ / ₈ x 13 ³ / ₈	WDH26310	25 ⁵ / ₈ x 19 ³ / ₈
WDH1832	15 ⁵ / ₈ x 15 ³ / ₈	WDH2642	25 ⁵ / ₈ x 21 ³ / ₈
WDH1836	15 ⁵ / ₈ x 17 ³ / ₈	WDH2646	25 ⁵ / ₈ x 23 ³ / ₈
WDH18310	15 ⁵ / ₈ x 19 ³ / ₈	WDH26410	25 ⁵ / ₈ x 25 ³ / ₈
WDH1842	15 ⁵ / ₈ x 21 ³ / ₈	WDH2652	25 ⁵ / ₈ x 27 ³ / ₈
WDH1846	15 ⁵ / ₈ x 23 ³ / ₈	WDH2656	25 ⁵ / ₈ x 29 ³ / ₈
WDH18410	15 ⁵ / ₈ x 25 ³ / ₈	WDH26510	25 ⁵ / ₈ x 31 ³ / ₈
WDH1852	15 ⁵ / ₈ x 27 ³ / ₈	WDH2662	25 ⁵ / ₈ x 33 ³ / ₈
WDH1856	15 ⁵ / ₈ x 29 ³ / ₈	WDH28210	27 ⁵ / ₈ x 13 ³ / ₈
WDH18510	15 ⁵ / ₈ x 31 ³ / ₈	WDH2832	27 ⁵ / ₈ x 15 ³ / ₈
WDH1862	15 ⁵ / ₈ x 33 ³ / ₈	WDH2836	27 ⁵ / ₈ x 17 ³ / ₈
WDH20210	19 ⁵ / ₈ x 13 ³ / ₈	WDH28310	27 ⁵ / ₈ x 19 ³ / ₈
WDH2032	19 ⁵ / ₈ x 15 ³ / ₈	WDH2842	27 ⁵ / ₈ x 21 ³ / ₈
WDH2036	19 ⁵ / ₈ x 17 ³ / ₈	WDH2846	27 ⁵ / ₈ x 23 ³ / ₈
WDH20310	19 ⁵ / ₈ x 19 ³ / ₈	WDH28410	27 ⁵ / ₈ x 25 ³ / ₈
WDH2042	19 ⁵ / ₈ x 21 ³ / ₈	WDH2852	27 ⁵ / ₈ x 27 ³ / ₈
WDH2046	19 ⁵ / ₈ x 23 ³ / ₈	WDH2856	27 ⁵ / ₈ x 29 ³ / ₈
WDH20410	19 ⁵ / ₈ x 25 ³ / ₈	WDH28510	27 ⁵ / ₈ x 31 ³ / ₈
WDH2052	19 ⁵ / ₈ x 27 ³ / ₈	WDH2862	27 ⁵ / ₈ x 33 ³ / ₈
WDH2056	19 ⁵ / ₈ x 29 ³ / ₈	WDH210210	29 ⁵ / ₈ x 13 ³ / ₈
WDH20510	19 ⁵ / ₈ x 31 ³ / ₈	WDH21032	29 ⁵ / ₈ x 15 ³ / ₈
WDH2062	19 ⁵ / ₈ x 33 ³ / ₈	WDH21036	29 ⁵ / ₈ x 17 ³ / ₈
WDH24210	23 ⁵ / ₈ x 13 ³ / ₈	WDH210310	29 ⁵ / ₈ x 19 ³ / ₈
WDH2432	23 ⁵ / ₈ x 15 ³ / ₈	WDH21042	29 ⁵ / ₈ x 21 ³ / ₈
WDH2436	23 ⁵ / ₈ x 17 ³ / ₈	WDH21046	29 ⁵ / ₈ x 23 ³ / ₈
WDH24310	23 ⁵ / ₈ x 19 ³ / ₈	WDH210410	29 ⁵ / ₈ x 25 ³ / ₈
WDH2442	23 ⁵ / ₈ x 21 ³ / ₈	WDH21052	29 ⁵ / ₈ x 27 ³ / ₈
WDH2446	23 ⁵ / ₈ x 23 ³ / ₈	WDH21056	29 ⁵ / ₈ x 29 ³ / ₈
WDH24410	23 ⁵ / ₈ x 25 ³ / ₈	WDH210510	29 ⁵ / ₈ x 31 ³ / ₈
WDH2452	23 ⁵ / ₈ x 27 ³ / ₈	WDH21062	29 ⁵ / ₈ x 33 ³ / ₈
WDH2456	23 ⁵ / ₈ x 29 ³ / ₈	WDH30210	31 ⁵ / ₈ x 13 ³ / ₈
WDH24510	23 ⁵ / ₈ x 31 ³ / ₈	WDH3032	31 ⁵ / ₈ x 15 ³ / ₈
WDH2462	23 ⁵ / ₈ x 33 ³ / ₈	WDH3036	31 ⁵ / ₈ x 17 ³ / ₈
WDH26210	25 ⁵ / ₈ x 13 ³ / ₈	WDH30310	31 ⁵ / ₈ x 19 ³ / ₈
WDH2632	25 ⁵ / ₈ x 15 ³ / ₈	WDH3042	31 ⁵ / ₈ x 21 ³ / ₈
WDH2636	25 ⁵ / ₈ x 17 ³ / ₈	WDH3046	31 ⁵ / ₈ x 23 ³ / ₈

400 Series Woodwright® Double-Hung Windows (2002 to Present)

Standard Windows

Sash

Sash Size Table			
Unit No.	Unobstructed Glass	Unit No.	Unobstructed Glass
WDH30410	31 ⁵ / ₈ x 25 ³ / ₈	WDH34510	35 ⁵ / ₈ x 31 ³ / ₈
WDH3052	31 ⁵ / ₈ x 27 ³ / ₈	WDH3462	35 ⁵ / ₈ x 33 ³ / ₈
WDH3056	31 ⁵ / ₈ x 29 ³ / ₈	WDH38210	39 ⁵ / ₈ x 13 ³ / ₈
WDH30510	31 ⁵ / ₈ x 31 ³ / ₈	WDH3832	39 ⁵ / ₈ x 15 ³ / ₈
WDH3062	31 ⁵ / ₈ x 33 ³ / ₈	WDH3836	39 ⁵ / ₈ x 17 ³ / ₈
WDH34210	35 ⁵ / ₈ x 13 ³ / ₈	WDH38310	39 ⁵ / ₈ x 19 ³ / ₈
WDH3432	35 ⁵ / ₈ x 15 ³ / ₈	WDH3842	39 ⁵ / ₈ x 21 ³ / ₈
WDH3436	35 ⁵ / ₈ x 17 ³ / ₈	WDH3846	39 ⁵ / ₈ x 23 ³ / ₈
WDH34310	35 ⁵ / ₈ x 19 ³ / ₈	WDH38410	39 ⁵ / ₈ x 25 ³ / ₈
WDH3442	35 ⁵ / ₈ x 21 ³ / ₈	WDH3852	39 ⁵ / ₈ x 27 ³ / ₈
WDH3446	35 ⁵ / ₈ x 23 ³ / ₈	WDH3856	39 ⁵ / ₈ x 29 ³ / ₈
WDH34410	35 ⁵ / ₈ x 25 ³ / ₈	WDH38510	39 ⁵ / ₈ x 31 ³ / ₈
WDH3452	35 ⁵ / ₈ x 27 ³ / ₈	WDH3862	39 ⁵ / ₈ x 33 ³ / ₈
WDH3456	35 ⁵ / ₈ x 29 ³ / ₈		

Sash

Sash-Upper

Upper Sash - Standard Window

Note:

See latest [Product Details](#).

See [Service Guide 0005435](#) for windows manufactured after October 2006.

See [Service Guide 0005347](#) for windows manufactured prior to October 2006.

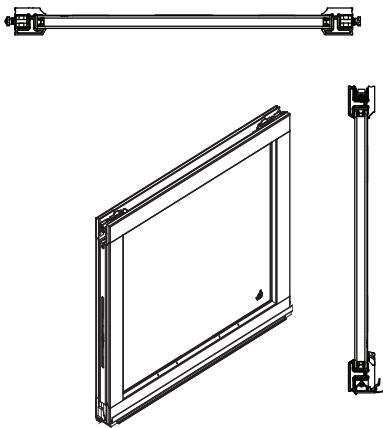

Note:

Replacement upper sash for standard and custom size windows is made to order. Sash ships with keeper, tilt latches and balancers. New design for keeper and tilt-latch introduced in March 2017.

Exterior color options:

White, Sandtone, Terratone®, Forest Green, Canvas, Dark Bronze, Black

Interior finish options:

Pine, Oak, Maple, or Primed (White)

Glass options include (See Logo example):

Low-E4®
Low-E4® SmartSun™
Low-E4® Sun

Tempered glass and other glass options are available.

Factory applied grille options:

Finelight™ grilles-between-the-glass
 High-definition grilles - Full divided light with spacer
 Simulated divided light without spacer
 Exterior grilles
 (Removable Interior grilles are available on [page 51](#))

Glass Logo

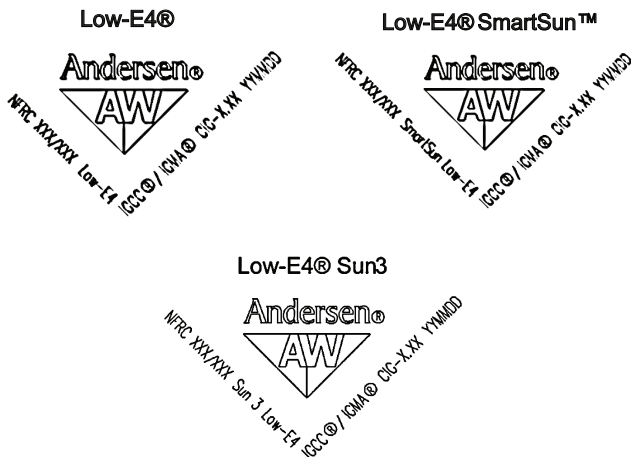

To order, state:

1. Description of Part (Upper Sash)
2. Quantity
3. Product ID (from product label, see [Service Guide 9051877](#))
4. Options Desired (if different than original product)

Sash-Lower

Lower Sash

Note:

See latest [Product Details](#).

See [Service Guide 0005435](#) for windows manufactured after October 2006.

See [Service Guide 0005347](#) for windows manufactured prior to October 2006.

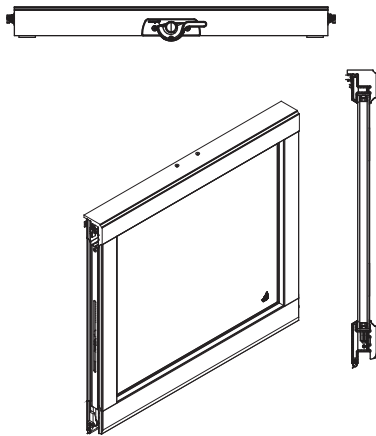

Note:

Replacement lower sash for standard and custom size windows is made to order. Sash ships with lock, tilt latches and balancers. New design for lock and tilt-latch introduced in March 2017.

Exterior color options:

White, Sandtone, Terratone®, Forest Green, Canvas, Dark Bronze, Black

Interior finish options:

Pine, Oak, Maple, or Primed (White)

Glass options include: (See [Logo example](#)):

Low-E4®
Low-E4® SmartSun™
Low-E4® Sun

Tempered glass and other glass options are available.

Factory applied grille options:

Finelight™ grilles-between-the-glass
High-definition grilles - Full divided light with spacer
Simulated divided light without spacer
Exterior grilles

(Removable Interior grilles are available on [page 51](#))

Glass Logo

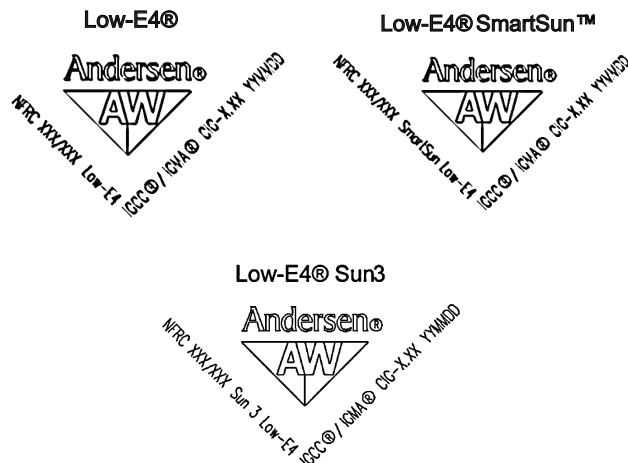

To order, state:

1. Description of Part (Lower Sash)
2. Quantity
3. Product ID (from product label, see [Service Guide 9051877](#))
4. Options Desired (if different than original product)

Sash

Weatherstrip

Weatherstrip - Interlock

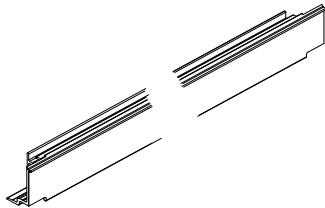

Upper Interlock

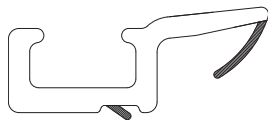

Lower Interlock

Note:

Upper and lower weatherstrip interlocks are made to order. Lineal lengths are available for service replacement. ([see page 75](#)).

To order, state:

1. **Description of Part (Upper or Lower Weatherstrip Interlock)**
2. **Quantity**
3. **Product ID (from product label, see [Service Guide 9051877](#))**

Weatherstrip - Lower Interlock / Lineal *(February 22, 2018 to present)*

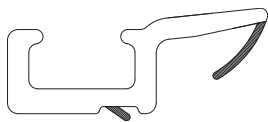

Note:

Cut to length if necessary. Also order [felt spacer](#) and screws.

Length

Order No.

28 ¹/₁₆

Configured by Product ID

36 ¹/₁₆

Configured by Product ID

52 ⁷/₁₆

Configured by Product ID

Screw - Lower Interlock

Description

Order No.

PH pan 8 - 15 x 3/8 #5 302 SS

0102714

Weatherstrip - Bottom Rail

Note:

See [Service Guide 0005402](#) and [Weatherstrip Replacement Video](#).

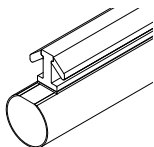

Length

Order No.

10 ft.

0102606

400 Series Woodwright® Double-Hung Windows (2002 to Present)

Standard Windows

Sash

Sash Hardware - Lifts

Lift w/Screws - Classic

Note:

See [Accessory Guide 0005180](#). Bar lift and hand lift quantity of one, finger lift quantity of two.

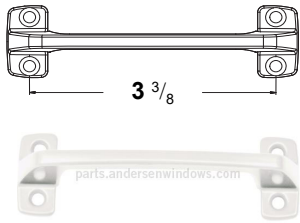
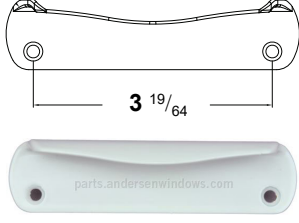
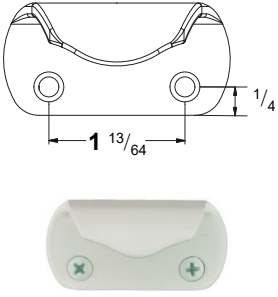
			
	Bar	Hand	Finger
Color	Order No.	Order No.	Order No.
White	1630025	1643002	1643004
Stone	1630027	1643001	1643003

Lift w/Screws - Traditional (8/2017 - Present)

Note:

For units manufactured from 1992 to July 2017 see Traditional style lifts in [A-Series Double-Hung](#) section.

Hand lift quantity of one, finger lift quantity of two. See [Accessory Guide 9166501](#). See [Accessory Guide 9159962](#).

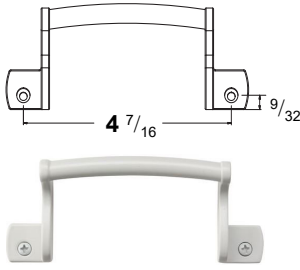
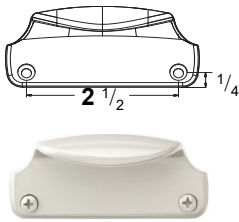
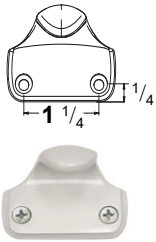
			
	Bar	Hand	Finger
Color	Order No.	Order No.	Order No.
White	9159470	9159482	9159494
Stone	9159471	9159483	9159495
Gold Dust	9159468	9159480	9159492
Black	9159469	9159481	9159493
Bright Brass	9159461	9159473	9159485
Satin Nickel	9159465	9159476	9159489
Oil-Rubbed Bronze	9159463	9159475	9159487
Antique Brass	9159460	9159472	9159484
Brushed Chrome	9159462	9159474	9159486
Polished Chrome	9159464	9159477	9159488
Distressed Bronze	9159466	9159478	9159490
Distressed Nickel	9159467	9159479	9159491

Sash

Lift w/Screws - Estate		
Note: See Accessory Guide 0005180 . Bar lift and hand lift quantity of one, finger lift quantity of two.		
	Hand	Finger
Color	Order No.	Order No.
Antique Brass	1600694	1600693
Bright Brass	1643043	1643040
Chrome	N/A	N/A
Brushed Chrome	N/A	N/A
Satin Nickel	1642922	1642920
Oil Rubbed Bronze	1642921	1642919
Distressed Bronze	1642932	1642931
Distressed Nickel	1600405	1600403

Lift w/Screws - Contemporary (August 2017 - Present)	
	Bar
Color	Order No.
White	9160290
Stone	9160291
Gold Dust	9160288
Black	9160289
Bright Brass	9160281
Satin Nickel	9160285
Oil-Rubbed Bronze	9160283
Antique Brass	9160280
Brushed Chrome	9160282
Polished Chrome	9160284
Distressed Bronze	9160286
Distressed Nickel	9160287

400 Series Woodwright® Double-Hung Windows (2002 to Present)

Standard Windows

Sash

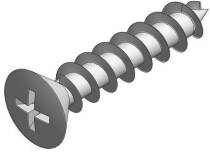
Screw - Finger Lift			
	Description	Finish	Order No.
	6 - 10 x 3/4" Typ AB PH SP oval STL H9	Stone	3620225
		White	3620226
		Gold Dust	9004465
		Black	9004466
		Bright Brass	9004467
		Satin Nickel	9004468
		Oil-Rubbed Bronze	9004469
		Antique Brass	9004470
		Brushed Chrome	9004471
		Polished Chrome	9004472

Sash

Sash Hardware - Lock Kits/Components

Lock/Keeper Kit (March 2017 to Present)

Note:

Active kit used on sash with one lock/keeper. Passive kit used on sash with two locks/keepers.

	Active Kit Includes: (1) Lock (1) Keeper (4) Screws Accessory Guide 9166409	Passive Kit Includes: (2) Locks (2) Keepers (8) Screws Accessory Guide 9166409	Finish	Active	Passive
			Bright Brass	9159918	9159930
			Antique Brass	9159914	9159926
			Brushed Chrome	9159920	9159932
			Polished Chrome	9159922	9159934
			Oil Rubbed Bronze	9159916	9159928
			Satin Nickel	9159923	9159935
			Distressed Bronze	9159915	9159927
			Distressed Nickel	9159921	9159933
			Black	9159917	9159929
			Gold Dust	9159919	9159931
			Stone	9159924	9159936
			White	9159925	9159937

Screw - Lock and Keeper

	Description:	Color	Order No.
	6-10 x 3/4" PLS Z PH SP oval STL ZD	Stone	3620225
		White	3620226
		Gold Dust	9004465
		Black	9004466
		Bright Brass	9004467
		Satin Nickel	9004468
		Oil-Rubbed Bronze	9004469
		Antique Brass	9004470
		Brushed Chrome	9004471
Polished Chrome		9004472	

Lock Set - Estate (2002 to March 2017)

Note:

See [Verilock](#) options for Estate Lock Sets.

	Set Includes: (1) Lock (1) Keeper (4) Screws Accessory Guide 0005256	Finish	Order No.
		Bright Brass	0102628
		Antique Brass	0102630
		Brushed Chrome	0102629
		Polished Chrome	0102632
		Oil Rubbed Bronze	0102631
		Satin Nickel	0102633
		Distressed Bronze	0102621
		Distressed Nickel	0102622



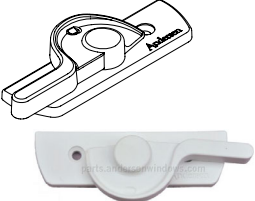
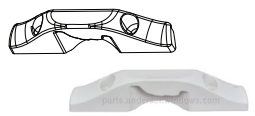

400 Series Woodwright® Double-Hung Windows (2002 to Present)

Standard Windows

Sash

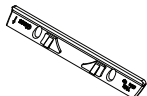
Lock (2002 to March 2017)			
	Note: Ships with screws.	Finish	Order No.
		Stone	0102006
		White	0102005
Keeper (2002 to March 2017)			
	Note: Ships with screws.	Finish	Order No.
		Stone	0102015
		White	0102014

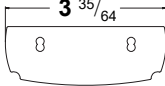
Screw - Lock and Keeper			
Note: See lock and keeper kits for finishes not shown.			
	Description	Finish	Order No.
	#8 x 1"	White	0102003
		Stone	0102004

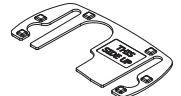
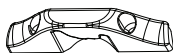
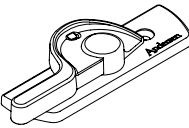
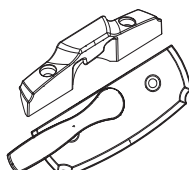
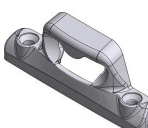
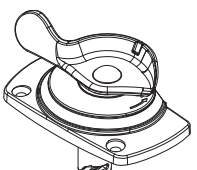
Shim Kits/Components					
Shim Kits	(2002 to March 2017)		(2002 to March 2017)	(March 2017 to Present)	
Shim					
Works with					
Color	Keeper	Lock	Estate Lock	Keeper	Lock
White	0100083	0100082	9173745	9159952	9159955
Stone	0100085	0100084	9173746	9159953	9159956
Black	-		-	9159954	9159957

Sash

Sash Hardware - Latch Kits

Tilt Latch Kit (March 2017 to Present)

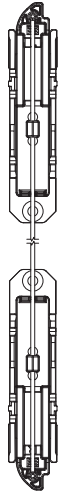
	Kit Includes: (2) Tilt Latches - upper (1) Latch Assembly - lower (1) Crimp Pin (4) Screws Service Guide 9166408	Order No.
		9159913

Tilt-Latch and Wash Assist Kit (2005 to March 2017)

Note:

See [Service Guide 0005417](#). See [Replacement Video](#). Tilt-latches secure to sash and wash assists secure to jamb liner.

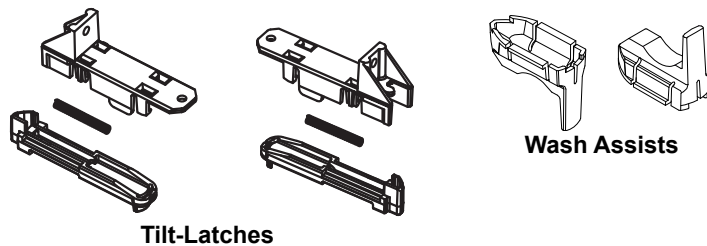

Kit Includes:

- (2) Tilt-latches
- (2) Wash assists

[Service Guide 0005417](#)

	Finish	Order No.
	White	0102091
	Gray	0102092

Sash Components - Miscellaneous

Screw - Check Rail Packaging Clip

	Description	Color	Order No.
	#8 - 10 x 1 3/16"	Stone	0873242
	Note: Used on packaging clip on check rail.	White	0873241

400 Series Woodwright® Double-Hung Windows (2002 to Present)

Standard Windows

Sash

Sash Hardware - Opening Control Device

Opening Control Device Kit

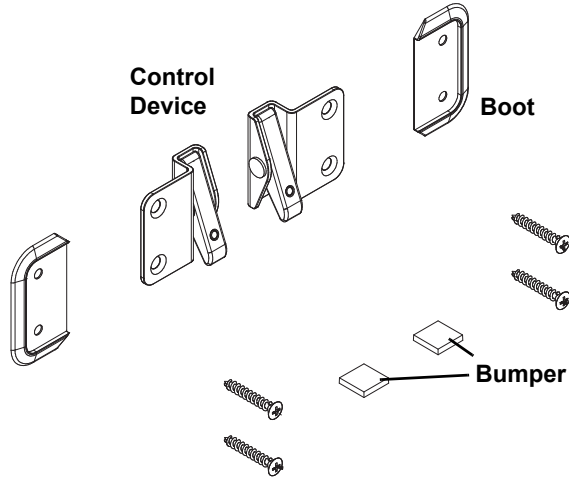

Kit Includes:

- (2) Opening control devices
- (2) Boots
- (4) Screws
- (2) Bumpers

[Accessory Guide 9021977](#)

	Finish	Order No.
	Stone	9021976
	White	9021975
	Black	9168018

Screw Pack - Opening Control Device Kit

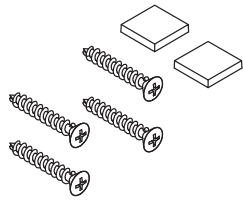

Kit Includes:

- (4) Screws
- (2) Bumpers

Color	Order No.
Stone	9031536
White	9031535
Black	9168019

Sash Balancers

Sash Balancers (October 2006 - present)

Note:

The balancer number can be found imprinted onto the side of each balancer. With that number, refer to the charts below to identify the correct order number for the replacement balancer(s). See [Service Guide 0005435](#). See [Balancer Replacement Video](#).

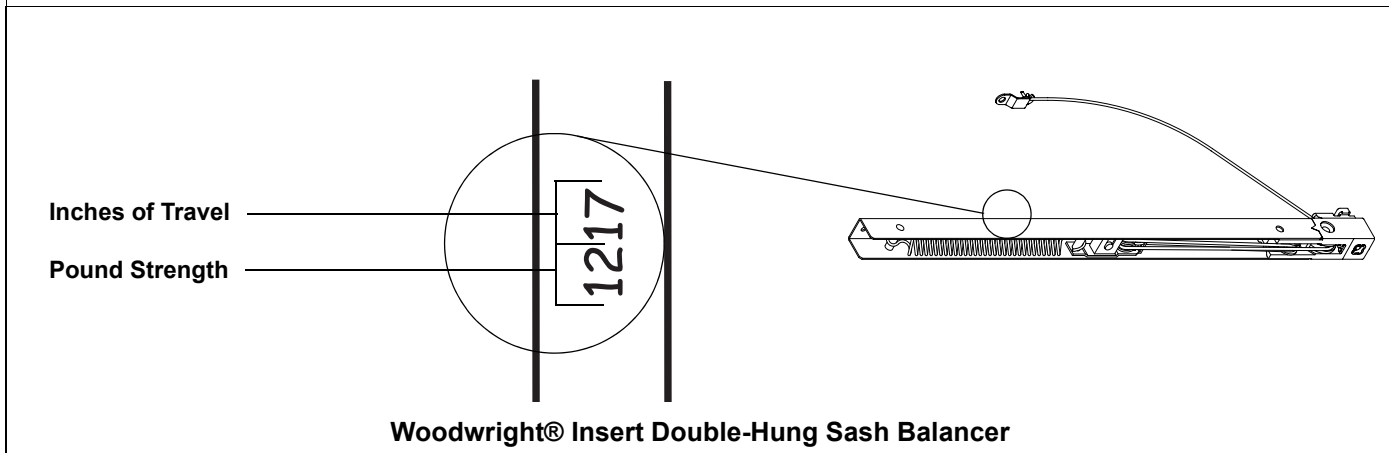

Sash Balancers (October 2006 - present) 3 lbs. - 8 lbs.

Balancer No.	Order No.	Balancer No.	Order No.	Balancer No.	Order No.	Balancer No.	Order No.
311	0102782	524	0102812	717	0102843	819	0102872
312	0102783	526	0102813	718	0102844	820	0102873
313	0102784	613	0102817	719	0102845	821	0102874
314	0102785	614	0102818	720	0102846	822	0102875
315	0102786	615	0102819	721	0102847	823	0102876
412	0102789	616	0102820	722	0102848	824	0102877
413	0102790	617	0102821	723	0102849	825	0102878
414	0102791	618	0102822	724	0102850	826	0102879
415	0102792	619	0102823	725	0102851	827	0102880
416	0102793	620	0102824	726	0102852	828	0102881
417	0102794	621	0102825	727	0102853	829	0102882
418	0102795	622	0102826	728	0102854	830	0102883
419	0102796	623	0102827	729	0102855	831	0102884
420	0102797	624	0102828	730	0102856	832	0102885
513	0102801	625	0102829	731	0102857	833	0102886
514	0102802	626	0102830	732	0102858	834	0102887
515	0102803	627	0102831	733	0102859	835	0102888
516	0102804	628	0102832	734	0102860	836	0102889
517	0102805	629	0102833	735	0102861	837	0102890
518	0102806	630	0102834	736	0102862	838	0102891
519	0102807	631	0102835	812	0102865	839	0102892
520	0102808	712	0102838	815	0102868	840	0102893
521	0102809	714	0102840	816	0102869	841	0102894
522	0102810	715	0102841	817	0102870		
523	0102811	716	0102842	818	0102871		

400 Series Woodwright® Double-Hung Windows (2002 to Present)

Standard Windows

Sash Balancers

Sash Balancers (October 2006 - present) 9 lbs. - 13 lbs.							
Balancer No.	Order No.	Balancer No.	Order No.	Balancer No.	Order No.	Balancer No.	Order No.
912	0102897	1023	0102945	1131	0102988	1242	0103034
915	0102901	1024	0102946	1132	0102989	1243	0103035
916	0102902	1025	0102947	1133	0102990	1244	0103036
917	0102903	1026	0102948	1134	0102991	1245	0103037
918	0102904	1027	0102949	1135	0102992	1318	0103042
919	0102905	1028	0102950	1136	0102993	1319	0103043
920	0102906	1029	0102951	1137	0102994	1320	0103044
921	0102907	1030	0102952	1138	0102995	1321	0103045
922	0102908	1031	0102953	1139	0102996	1322	0103046
923	0102909	1032	0102954	1140	0102997	1323	0103047
924	0102910	1033	0102955	1141	0102998	1324	0103048
925	0102911	1034	0102956	1142	0102999	1325	0103049
926	0102912	1035	0102957	1143	0103001	1326	0103050
927	0102913	1036	0102958	1144	0103002	1327	0103051
928	0102914	1037	0102959	1145	0103003	1328	0103052
929	0102915	1038	0102960	1214	0103006	1329	0103053
930	0102916	1039	0102961	1217	0103009	1330	0103054
931	0102917	1040	0102962	1218	0103010	1331	0103055
932	0102918	1041	0102963	1219	0103011	1332	0103056
933	0102919	1042	0102964	1220	0103012	1333	0103057
934	0102920	1043	0102965	1221	0103013	1334	0103058
935	0102921	1044	0102966	1222	0103014	1335	0103059
936	0102922	1045	0102967	1223	0103015	1336	0103060
937	0102923	1112	0102969	1224	0103016	1337	0103061
938	0102924	1113	0102970	1225	0103017	1338	0103062
939	0102925	1114	0102971	1226	0103018	1339	0103063
940	0102926	1116	0102973	1227	0103019	1340	0103064
941	0102927	1117	0102974	1228	0103020	1341	0103065
942	0102928	1118	0102975	1229	0103021	1342	0103066
943	0102929	1119	0102976	1230	0103022	1343	0103067
944	0102930	1120	0102977	1231	0103023	1344	0103068
945	0102931	1121	0102978	1232	0103024	1345	0103069
1012	0102934	1122	0102979	1233	0103025		
1013	0102935	1123	0102980	1234	0103026		
1016	0102938	1124	0102981	1235	0103027		
1017	0102939	1125	0102982	1236	0103028		
1018	0102940	1126	0102983	1237	0103029		
1019	0102941	1127	0102984	1238	0103030		
1020	0102942	1128	0102985	1239	0103031		
1021	0102943	1129	0102986	1240	0103032		
1022	0102944	1130	0102987	1241	0103033		

Sash Balancers

Sash Balancers (October 2006 - present) 14 lbs. - 20 lbs.							
Balancer No.	Order No.	Balancer No.	Order No.	Balancer No.	Order No.	Balancer No.	Order No.
1420	0103074	1533	0103117	1724	0103164	1842	0103208
1421	0103075	1534	0103118	1725	0103165	1843	0103209
1422	0103076	1535	0103119	1726	0103166	1844	0103210
1423	0103077	1536	0103120	1727	0103167	1845	0103211
1424	0103078	1537	0103121	1728	0103168	1925	0103215
1425	0103079	1538	0103122	1729	0103169	1926	0103216
1426	0103080	1539	0103123	1730	0103170	1927	0103217
1427	0103081	1540	0103124	1731	0103171	1928	0103218
1428	0103082	1541	0103125	1732	0103172	1929	0103219
1429	0103083	1542	0103126	1733	0103173	1930	0103220
1430	0103084	1543	0103127	1734	0103174	1931	0103221
1431	0103085	1544	0103128	1735	0103175	1932	0103222
1432	0103086	1545	0103129	1736	0103176	1933	0103223
1433	0103087	1622	0103135	1737	0103177	1934	0103224
1434	0103088	1623	0103136	1738	0103178	1935	0103225
1435	0103089	1624	0103137	1739	0103179	1936	0103226
1436	0103090	1625	0103138	1740	0103180	1937	0103227
1437	0103091	1626	0103139	1741	0103181	1938	0103228
1438	0103092	1627	0103140	1742	0103182	1939	0103229
1439	0103093	1628	0103141	1743	0103183	1940	0103231
1440	0103094	1629	0103142	1744	0103184	1941	0103232
1441	0103095	1630	0103143	1745	0103185	1942	0103233
1442	0103096	1631	0103144	1825	0103190	1943	0103234
1443	0103097	1632	0103145	1826	0103191	1945	0103235
1444	0103098	1633	0103146	1827	0103192	2024	0103236
1445	0103099	1634	0103147	1828	0103193	2025	0103237
1520	0103104	1635	0103148	1829	0103194	2026	0103238
1521	0103105	1636	0103149	1830	0103195	2027	0103239
1522	0103106	1637	0103150	1831	0103196	2028	0103240
1523	0103107	1638	0103151	1832	0103197	2029	0103241
1524	0103108	1639	0103152	1833	0103198	2030	0103242
1525	0103109	1640	0103153	1834	0103199	2031	0103243
1526	0103110	1641	0103154	1835	0103201	2032	0103244
1527	0103111	1642	0103155	1836	0103202	2033	0103245
1528	0103112	1643	0103156	1837	0103203	2034	0103246
1529	0103113	1644	0103157	1838	0103204	2035	0103247
1530	0103114	1645	0103158	1839	0103205	2036	0103248
1531	0103115	1722	0103162	1840	0103206	2037	0103249
1532	0103116	1723	0103163	1841	0103207	2038	0103250

400 Series Woodwright® Double-Hung Windows (2002 to Present)

Standard Windows

Sash Balancers

Sash Balancers (20 lbs. - 23 lbs.)							
Balancer No.	Order No.	Balancer No.	Order No.	Balancer No.	Order No.	Balancer No.	Order No.
2039	0103251	2133	0103264	2139	0103270	2243	0103292
2040	0103252	2134	0103265	2140	0103271	2244	0103293
2041	0103253	2135	0103266	2141	0103272	2245	0103294
2042	0103254	2136	0103267	2142	0103273	2335	0103302
2043	0103255	2137	0103268	2143	0103274		
2044	0103256	2138	0103269	2144	0103275		

Vintage Sash Balancers (2002 - October 2006)							
Note: If N/A, use current balancers as replacement, replacing balancers on upper sash and lower sash.							
Sash Balancer (2002 - October 2006) 3 lbs.							
Balancer No.	Inches of Travel	Order No.	Replacement	Balancer No.	Inches of Travel	Order No.	Replacement
310	10	N/A	Current	313	13	N/A	Current
311	11	N/A	Current	314	14	N/A	Current
312	12	N/A	Current	315	15	N/A	Current
Sash Balancer (2002 - October 2006) 4 lbs.							
Balancer No.	Inches of Travel	Order No.	Replacement	Balancer No.	Inches of Travel	Order No.	Replacement
410	10	N/A	Current	416	16	N/A	Current
411	11	N/A	Current	417	16	N/A	Current
412	12	N/A	Current	418	18	N/A	Current
413	13	N/A	Current	419	19	N/A	Current
414	14	N/A	Current	420	20	N/A	Current
415	15	N/A	Current				
Sash Balancer (2002 - October 2006) 5 lbs.							
Balancer No.	Inches of Travel	Order No.	Replacement	Balancer No.	Inches of Travel	Order No.	Replacement
510	10	N/A	Current	519	19	N/A	Current
511	11	N/A	Current	520	20	N/A	Current
512	12	N/A	Current	521	21	N/A	Current
513	13	N/A	Current	522	22	N/A	Current
514	14	N/A	Current	523	23	N/A	Current
515	15	N/A	Current	524	24	N/A	Current
516	16	N/A	Current	525	25	N/A	Current
517	17	N/A	Current	526	26	N/A	Current
518	18	N/A	Current				

Sash Balancers

Sash Balancer (2002 - October 2006) 6 lbs.							
Balancer No.	Inches of Travel	Order No.	Replacement	Balancer No.	Inches of Travel	Order No.	Replacement
610	10	N/A	Current	621	21	N/A	Current
611	11	N/A	Current	622	22	N/A	Current
612	12	N/A	Current	623	23	N/A	Current
613	13	N/A	Current	624	24	N/A	Current
614	14	N/A	Current	625	25	N/A	Current
615	15	N/A	Current	626	26	N/A	Current
616	16	N/A	Current	627	27	N/A	Current
617	17	N/A	Current	628	28	N/A	Current
618	18	N/A	Current	629	29	N/A	Current
619	19	N/A	Current	630	30	N/A	Current
620	20	N/A	Current	631	31	N/A	Current
Sash Balancer (2002 - October 2006) 7 lbs.							
Balancer No.	Inches of Travel	Order No.	Replacement	Balancer No.	Inches of Travel	Order No.	Replacement
710	10	N/A	Current	724	24	N/A	Current
711	11	N/A	Current	725	25	N/A	Current
712	12	N/A	Current	726	26	N/A	Current
713	13	N/A	Current	727	27	N/A	Current
714	14	N/A	Current	728	28	N/A	Current
715	15	N/A	Current	729	29	N/A	Current
716	16	N/A	Current	730	30	N/A	Current
717	17	N/A	Current	731	31	N/A	Current
718	18	N/A	Current	732	32	N/A	Current
719	19	N/A	Current	733	33	N/A	Current
720	20	N/A	Current	734	34	N/A	Current
721	21	N/A	Current	735	35	N/A	Current
722	22	N/A	Current	736	36	N/A	Current
723	23	N/A	Current				

400 Series Woodwright® Double-Hung Windows (2002 to Present)

Standard Windows

Sash Balancers

Sash Balancer (2002 - October 2006) 8 lbs.							
Balancer No.	Inches of Travel	Order No.	Replacement	Balancer No.	Inches of Travel	Order No.	Replacement
810	10	N/A	Current	826	26	N/A	Current
811	11	N/A	Current	827	27	N/A	Current
812	12	N/A	Current	828	28	N/A	Current
813	13	N/A	Current	829	29	N/A	Current
814	14	N/A	Current	830	30	N/A	Current
815	15	N/A	Current	831	31	N/A	Current
816	16	N/A	Current	832	32	N/A	Current
817	17	N/A	Current	833	33	N/A	Current
818	18	N/A	Current	834	34	N/A	Current
819	19	N/A	Current	835	35	N/A	Current
820	20	N/A	Current	836	36	N/A	Current
821	21	N/A	Current	837	37	N/A	Current
822	22	N/A	Current	838	38	N/A	Current
823	23	N/A	Current	839	39	N/A	Current
824	24	N/A	Current	840	40	N/A	Current
825	25	N/A	Current	841	41	N/A	Current
Sash Balancer (2002 - October 2006) 9 lbs.							
Balancer No.	Inches of Travel	Order No.	Replacement	Balancer No.	Inches of Travel	Order No.	Replacement
910	10	N/A	Current	928	28	N/A	Current
911	11	N/A	Current	929	29	N/A	Current
912	12	N/A	Current	930	30	N/A	Current
913	13	N/A	Current	931	31	N/A	Current
914	14	N/A	Current	932	32	N/A	Current
915	15	N/A	Current	933	33	N/A	Current
916	16	N/A	Current	934	34	N/A	Current
917	17	N/A	Current	935	35	N/A	Current
918	18	N/A	Current	936	36	N/A	Current
919	19	N/A	Current	937	37	N/A	Current
920	20	N/A	Current	938	38	N/A	Current
921	21	N/A	Current	939	39	N/A	Current
922	22	N/A	Current	940	40	N/A	Current
923	23	N/A	Current	941	41	N/A	Current
924	24	N/A	Current	942	42	N/A	Current
925	25	N/A	Current	943	43	N/A	Current
926	26	N/A	Current	944	44	N/A	Current
927	27	N/A	Current	945	45	N/A	Current

Sash Balancers

Sash Balancer (2002 - October 2006) 10 lbs.							
Balancer No.	Inches of Travel	Order No.	Replacement	Balancer No.	Inches of Travel	Order No.	Replacement
1010	10	N/A	Current	1028	28	N/A	Current
1011	11	N/A	Current	1029	29	N/A	Current
1012	12	N/A	Current	1030	30	N/A	Current
1013	13	N/A	Current	1031	31	N/A	Current
1014	14	N/A	Current	1032	32	N/A	Current
1015	15	N/A	Current	1033	33	N/A	Current
1016	16	N/A	Current	1034	34	N/A	Current
1017	17	N/A	Current	1035	35	N/A	Current
1018	18	N/A	Current	1036	36	N/A	Current
1019	19	N/A	Current	1037	37	N/A	Current
1020	20	N/A	Current	1038	38	N/A	Current
1021	21	N/A	Current	1039	39	N/A	Current
1022	22	N/A	Current	1040	40	N/A	Current
1023	23	N/A	Current	1041	41	N/A	Current
1024	24	N/A	Current	1042	42	N/A	Current
1025	25	N/A	Current	1043	43	N/A	Current
1026	26	N/A	Current	1044	44	N/A	Current
1027	27	N/A	Current	1045	45	N/A	Current
Sash Balancer (2002 - October 2006) 11 lbs.							
Balancer No.	Inches of Travel	Order No.	Replacement	Balancer No.	Inches of Travel	Order No.	Replacement
1111	11	N/A	Current	1129	29	N/A	Current
1112	12	N/A	Current	1130	30	N/A	Current
1113	13	N/A	Current	1131	31	N/A	Current
1114	14	N/A	Current	1132	32	N/A	Current
1115	15	N/A	Current	1133	33	N/A	Current
1116	16	N/A	Current	1134	34	N/A	Current
1117	17	N/A	Current	1135	35	N/A	Current
1118	18	N/A	Current	1136	36	N/A	Current
1119	19	N/A	Current	1137	37	N/A	Current
1120	20	N/A	Current	1138	38	N/A	Current
1121	21	N/A	Current	1139	39	N/A	Current
1122	22	N/A	Current	1140	40	N/A	Current
1123	23	N/A	Current	1141	41	N/A	Current
1124	24	N/A	Current	1142	42	N/A	Current
1125	25	N/A	Current	1143	43	N/A	Current
1126	26	N/A	Current	1144	44	N/A	Current
1127	27	N/A	Current	1145	45	N/A	Current
1128	28	N/A	Current				

400 Series Woodwright® Double-Hung Windows (2002 to Present)

Standard Windows

Sash Balancers

Sash Balancer - 12 Pound Strength (2002 - October 2006) 12 lbs.							
Balancer No.	Inches of Travel	Order No.	Replacement	Balancer No.	Inches of Travel	Order No.	Replacement
1212	12	N/A	Current	1229	29	N/A	Current
1213	13	N/A	Current	1230	30	N/A	Current
1214	14	N/A	Current	1231	31	N/A	Current
1215	15	N/A	Current	1232	32	N/A	Current
1216	16	N/A	Current	1233	33	N/A	Current
1217	17	N/A	Current	1234	34	N/A	Current
1218	18	N/A	Current	1235	35	N/A	Current
1219	19	N/A	Current	1236	36	N/A	Current
1220	20	N/A	Current	1237	37	N/A	Current
1221	21	N/A	Current	1238	38	N/A	Current
1222	22	N/A	Current	1239	39	N/A	Current
1223	23	N/A	Current	1240	40	N/A	Current
1224	24	N/A	Current	1241	41	N/A	Current
1225	25	N/A	Current	1242	42	N/A	Current
1226	26	N/A	Current	1243	43	N/A	Current
1227	27	N/A	Current	1244	44	N/A	Current
1228	28	N/A	Current	1245	45	N/A	Current
Sash Balancer (2002 - October 2006) 13 lbs.							
Balancer No.	Inches of Travel	Order No.	Replacement	Balancer No.	Inches of Travel	Order No.	Replacement
1314	14	N/A	Current	1330	30	N/A	Current
1315	15	N/A	Current	1331	31	N/A	Current
1316	16	N/A	Current	1332	32	N/A	Current
1317	17	N/A	Current	1333	33	N/A	Current
1318	18	N/A	Current	1334	34	N/A	Current
1319	19	N/A	Current	1335	35	N/A	Current
1320	20	N/A	Current	1336	36	N/A	Current
1321	21	N/A	Current	1337	37	N/A	Current
1322	22	N/A	Current	1338	38	N/A	Current
1323	23	N/A	Current	1339	39	N/A	Current
1324	24	N/A	Current	1340	40	N/A	Current
1325	25	N/A	Current	1341	41	N/A	Current
1326	26	N/A	Current	1342	42	N/A	Current
1327	27	N/A	Current	1343	43	N/A	Current
1328	28	N/A	Current	1344	44	N/A	Current
1329	29	N/A	Current	1345	45	N/A	Current

Sash Balancers

Sash Balancer (2002 - October 2006) 14 lbs.							
Balancer No.	Inches of Travel	Order No.	Replacement	Balancer No.	Inches of Travel	Order No.	Replacement
1416	16	N/A	Current	1431	31	N/A	Current
1417	17	N/A	Current	1432	32	N/A	Current
1418	18	N/A	Current	1433	33	N/A	Current
1419	19	N/A	Current	1434	34	N/A	Current
1420	20	N/A	Current	1435	35	N/A	Current
1421	21	N/A	Current	1436	36	N/A	Current
1422	22	N/A	Current	1437	37	N/A	Current
1423	23	N/A	Current	1438	38	N/A	Current
1424	24	N/A	Current	1439	39	N/A	Current
1425	25	N/A	Current	1440	40	N/A	Current
1426	26	N/A	Current	1441	41	N/A	Current
1427	27	N/A	Current	1442	42	N/A	Current
1428	28	N/A	Current	1443	43	N/A	Current
1429	29	N/A	Current	1444	44	N/A	Current
1430	30	N/A	Current	1445	45	N/A	Current
Sash Balancer (2002 - October 2006) 15 lbs.							
Balancer No.	Inches of Travel	Order No.	Replacement	Balancer No.	Inches of Travel	Order No.	Replacement
1517	17	N/A	Current	1532	32	N/A	Current
1518	18	N/A	Current	1533	33	N/A	Current
1519	19	N/A	Current	1534	34	N/A	Current
1520	20	N/A	Current	1535	35	N/A	Current
1521	21	N/A	Current	1536	36	N/A	Current
1522	22	N/A	Current	1537	37	N/A	Current
1523	23	N/A	Current	1538	38	N/A	Current
1524	24	N/A	Current	1539	39	N/A	Current
1525	25	N/A	Current	1540	40	N/A	Current
1526	26	N/A	Current	1541	41	N/A	Current
1527	27	N/A	Current	1542	42	N/A	Current
1528	28	N/A	Current	1543	43	N/A	Current
1529	29	N/A	Current	1544	44	N/A	Current
1530	30	N/A	Current	1545	45	N/A	Current
1531	31	N/A	Current				

400 Series Woodwright® Double-Hung Windows (2002 to Present)

Standard Windows

Sash Balancers

Sash Balancer (2002 - October 2006) 16 lbs.							
Balancer No.	Inches of Travel	Order No.	Replacement	Balancer No.	Inches of Travel	Order No.	Replacement
1617	17	N/A	Current	1632	32	N/A	Current
1618	18	N/A	Current	1633	33	N/A	Current
1619	19	N/A	Current	1634	34	N/A	Current
1620	20	N/A	Current	1635	35	N/A	Current
1621	21	N/A	Current	1636	36	N/A	Current
1622	22	N/A	Current	1637	37	N/A	Current
1623	23	N/A	Current	1638	38	N/A	Current
1624	24	N/A	Current	1639	39	N/A	Current
1625	25	N/A	Current	1640	40	N/A	Current
1626	26	N/A	Current	1641	41	N/A	Current
1627	27	N/A	Current	1642	42	N/A	Current
1628	28	N/A	Current	1643	43	N/A	Current
1629	29	N/A	Current	1644	44	N/A	Current
1630	30	N/A	Current	1645	45	N/A	Current
1631	31	N/A	Current				
Sash Balancer (2002 - October 2006) 17 lbs.							
Balancer No.	Inches of Travel	Order No.	Replacement	Balancer No.	Inches of Travel	Order No.	Replacement
1719	19	N/A	Current	1733	33	N/A	Current
1720	20	N/A	Current	1734	34	N/A	Current
1721	21	N/A	Current	1735	35	N/A	Current
1722	22	N/A	Current	1736	36	N/A	Current
1723	23	N/A	Current	1737	37	N/A	Current
1724	24	N/A	Current	1738	38	N/A	Current
1725	25	N/A	Current	1739	39	N/A	Current
1726	26	N/A	Current	1740	40	N/A	Current
1727	27	N/A	Current	1741	41	N/A	Current
1728	28	N/A	Current	1742	42	N/A	Current
1729	29	N/A	Current	1743	43	N/A	Current
1730	30	N/A	Current	1744	44	N/A	Current
1731	31	N/A	Current	1745	45	N/A	Current
1732	32	N/A	Current				

Sash Balancers

Sash Balancer (2002 - October 2006) 18 lbs.							
Balancer No.	Inches of Travel	Order No.	Replacement	Balancer No.	Inches of Travel	Order No.	Replacement
1821	21	N/A	Current	1834	34	N/A	Current
1822	22	N/A	Current	1835	35	N/A	Current
1823	23	N/A	Current	1836	36	N/A	Current
1824	24	N/A	Current	1837	37	N/A	Current
1825	25	N/A	Current	1838	38	N/A	Current
1826	26	N/A	Current	1839	39	N/A	Current
1827	27	N/A	Current	1840	40	N/A	Current
1828	28	N/A	Current	1841	41	N/A	Current
1829	29	N/A	Current	1842	42	N/A	Current
1830	30	N/A	Current	1843	43	N/A	Current
1831	31	N/A	Current	1844	44	N/A	Current
1832	32	N/A	Current	1845	45	N/A	Current
1833	33	N/A	Current				
Sash Balancer (2002 - October 2006) 19 lbs.							
Balancer No.	Inches of Travel	Order No.	Replacement	Balancer No.	Inches of Travel	Order No.	Replacement
1926	26	N/A	Current	1938	38	N/A	Current
1927	27	N/A	Current	1939	39	N/A	Current
1928	28	N/A	Current	1940	40	N/A	Current
1929	29	N/A	Current	1941	41	N/A	Current
1930	30	N/A	Current	1942	42	N/A	Current
1931	31	N/A	Current	1943	43	N/A	Current
1932	32	N/A	Current	1944	44	N/A	Current
1933	33	N/A	Current	1945	22	N/A	Current
1934	34	N/A	Current	1946	23	N/A	Current
1935	35	N/A	Current	1947	24	N/A	Current
1936	36	N/A	Current	1948	25	N/A	Current
1937	37	N/A	Current	1949	45	N/A	Current

400 Series Woodwright® Double-Hung Windows (2002 to Present)

Standard Windows

Sash Balancers

Sash Balancer (2002 - October 2006) 20 lbs.							
Balancer No.	Inches of Travel	Order No.	Replacement	Balancer No.	Inches of Travel	Order No.	Replacement
2024	24	N/A	Current	2035	35	N/A	Current
2025	25	N/A	Current	2036	36	N/A	Current
2026	26	N/A	Current	2037	37	N/A	Current
2027	27	N/A	Current	2038	38	N/A	Current
2028	28	N/A	Current	2039	39	N/A	Current
2029	29	N/A	Current	2040	40	N/A	Current
2030	30	N/A	Current	2041	41	N/A	Current
2031	31	N/A	Current	2042	42	N/A	Current
2032	32	N/A	Current	2043	43	N/A	Current
2033	33	N/A	Current	2044	44	N/A	Current
2034	34	N/A	Current	2045	45	N/A	Current
Sash Balancer (2002 - October 2006) 21 lbs.							
Balancer No.	Inches of Travel	Order No.	Replacement	Balancer No.	Inches of Travel	Order No.	Replacement
2126	26	N/A	Current	2136	36	N/A	Current
2127	27	N/A	Current	2137	37	N/A	Current
2128	28	N/A	Current	2138	38	N/A	Current
2129	29	N/A	Current	2139	39	N/A	Current
2130	30	N/A	Current	2140	40	N/A	Current
2131	31	N/A	Current	2141	41	N/A	Current
2132	32	N/A	Current	2142	42	N/A	Current
2133	33	N/A	Current	2143	43	N/A	Current
2134	34	N/A	Current	2144	44	N/A	Current
2135	35	N/A	Current	2145	45	N/A	Current
Sash Balancer (2002 - October 2006) 22 lbs.							
Balancer No.	Inches of Travel	Order No.	Replacement	Balancer No.	Inches of Travel	Order No.	Replacement
2227	27	N/A	Current	2237	37	N/A	Current
2228	28	N/A	Current	2238	38	N/A	Current
2229	29	N/A	Current	2239	39	N/A	Current
2230	30	N/A	Current	2240	40	N/A	Current
2231	31	N/A	Current	2241	41	N/A	Current
2232	32	N/A	Current	2242	42	N/A	Current
2233	33	N/A	Current	2243	43	N/A	Current
2234	34	N/A	Current	2244	44	N/A	Current
2235	35	N/A	Current	2245	45	N/A	Current
2236	36	N/A	Current				

Sash Balancers

Sash Balancer (2002 - October 2006) 23 lbs.							
Balancer No.	Inches of Travel	Order No.	Replacement	Balancer No.	Inches of Travel	Order No.	Replacement
2329	29	N/A	Current	2338	38	N/A	Current
2330	30	N/A	Current	2339	39	N/A	Current
2331	31	N/A	Current	2340	40	N/A	Current
2332	32	N/A	Current	2341	41	N/A	Current
2333	33	N/A	Current	2342	42	N/A	Current
2334	34	N/A	Current	2343	43	N/A	Current
2335	35	N/A	Current	2344	44	N/A	Current
2336	36	N/A	Current	2345	45	N/A	Current
2337	37	N/A	Current				
Sash Balancer (2002 - October 2006) 24 lbs.							
Balancer No.	Inches of Travel	Order No.	Replacement	Balancer No.	Inches of Travel	Order No.	Replacement
2429	29	N/A	Current	2438	38	N/A	Current
2430	30	N/A	Current	2439	39	N/A	Current
2431	31	N/A	Current	2440	40	N/A	Current
2432	32	N/A	Current	2441	41	N/A	Current
2433	33	N/A	Current	2442	42	N/A	Current
2434	34	N/A	Current	2443	43	N/A	Current
2435	35	N/A	Current	2444	44	N/A	Current
2436	36	N/A	Current	2445	45	N/A	Current
2437	37	N/A	Current				
Sash Balancer (2002 - October 2006) 25 lbs.							
Balancer No.	Inches of Travel	Order No.	Replacement	Balancer No.	Inches of Travel	Order No.	Replacement
2530	30	N/A	Current	2538	38	N/A	Current
2531	31	N/A	Current	2539	39	N/A	Current
2532	32	N/A	Current	2540	40	N/A	Current
2533	33	N/A	Current	2541	41	N/A	Current
2534	34	N/A	Current	2542	42	N/A	Current
2535	35	N/A	Current	2543	43	N/A	Current
2536	36	N/A	Current	2544	44	N/A	Current
2537	37	N/A	Current	2545	45	N/A	Current

400 Series Woodwright® Double-Hung Windows (2002 to Present)

Standard Windows

Sash Balancers

Sash Balancer (2002 - October 2006) 26 lbs.							
Balancer No.	Inches of Travel	Order No.	Replacement	Balancer No.	Inches of Travel	Order No.	Replacement
2632	32	N/A	Current	2639	39	N/A	Current
2633	33	N/A	Current	2640	40	N/A	Current
2634	34	N/A	Current	2641	41	N/A	Current
2635	35	N/A	Current	2642	42	N/A	Current
2636	36	N/A	Current	2643	43	N/A	Current
2637	37	N/A	Current	2644	44	N/A	Current
2638	38	N/A	Current	2645	45	N/A	Current
Sash Balancer (2002 - October 2006) 27 lbs.							
Balancer No.	Inches of Travel	Order No.	Replacement	Balancer No.	Inches of Travel	Order No.	Replacement
2739	39	N/A	Current	2743	43	N/A	Current
2740	40	N/A	Current	2744	44	N/A	Current
2741	41	N/A	Current	2745	45	N/A	Current
2742	42	N/A	Current				
Sash Balancer (2002 - October 2006) 28 lbs.							
Balancer No.	Inches of Travel	Order No.	Replacement	Balancer No.	Inches of Travel	Order No.	Replacement
2840	40	N/A	Current	2843	43	N/A	Current
2841	41	N/A	Current	2844	44	N/A	Current
2842	42	N/A	Current	2845	45	N/A	Current
Sash Balancer (2002 - October 2006) 29 lbs.							
Balancer No.	Inches of Travel	Order No.	Replacement	Balancer No.	Inches of Travel	Order No.	Replacement
2942	42	N/A	Current	2944	44	N/A	Current
2943	43	N/A	Current	2945	45	N/A	Current
Sash Balancer (2002 - October 2006) 30 lbs.							
Balancer No.	Inches of Travel	Order No.	Replacement	Balancer No.	Inches of Travel	Order No.	Replacement
3044	44	N/A	Current	3045	45	N/A	Current

Sash Balancers

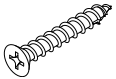
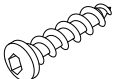
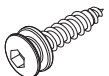
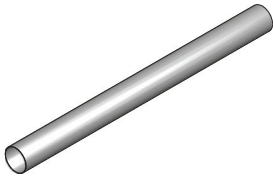
Sash Balancer Hardware		
Screw - Bottom Balance Hole		
	Description	Order No.
	8 - 18 x 2 PH #6 pan HD YMZ T-17 T/C	0102625
Screw - Top Balance Hole		
	Description	Order No.
	8 - 10 x 1-3/16 PH flat HD plask #2 w/shank slot	0102624
Screw - Terminal End Balance		
	Description	Order No.
	8 - 18 x 3/4 1/8 HX sic N #10 HD T-17 ZC	0102626
Screw - Shoulder		
	Description	Package of 2
	#8 x 5/8"	0112045
Balance Spring Sleeve		
		
	Order No. 9098415	

400 Series Woodwright® Double-Hung Windows (2002 to Present)

Standard Windows

Sash Balancers

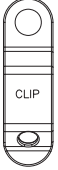
Balancer Clip (May 2009 to Present)		
 <p>A vertical, oval-shaped metal clip with a circular hole at the top and a small circular hole at the bottom. The word "CLIP" is printed in the center.</p>	<p>Note: Balance cord clip attaches to side jamb. Replaces previous vintages.</p>	Order No.
		9019790

Screw - Balancer Clip (May 2009 to Present)		
 <p>A cross-recessed screw with a hexagonal head and a sharp point.</p>	Description	Order No.
	<p>8 - 15 x 5/8 Cross Recess #6 Truss HD Type 17</p> <p>Note: Used to secure balance cord clip to side jamb.</p>	1521125

Screw - Balancer Clip (December 2007 to April 2009)		
 <p>A pan-head screw with a sharp point.</p>	Description	Order No.
	<p>8 - 15 x 5/8 #10 pan HD type 17</p> <p>Note: Used to secure balance cord clip to side jamb.</p>	9000915

Insect Screens

Insect Screens - Full / TruScene®

Note:

Standard size units use the same insect screens as 400 Series Tilt-Wash units (listed below). See 400 Series Tilt-Wash section for cottage insect screens. Insect screens for custom size windows are made to order. Half insect screens (see [page 49](#)) are made to order.

To order, state:

1. Description of Part (Full Insect Screen)
2. Quantity
3. Product ID (from product label, see [Service Guide 9051877](#))

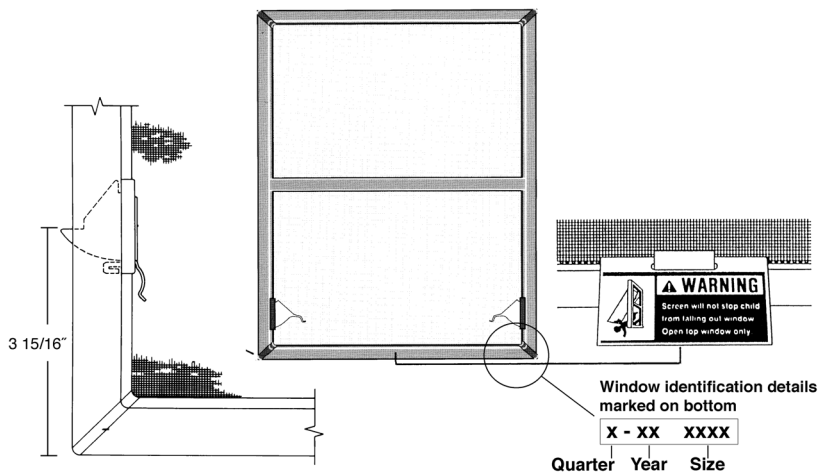

Woodwright® Double-Hung Full Insect Screen

400 Series Woodwright® Double-Hung Windows (2002 to Present)

Standard Windows

Insect Screens

Insect Screen - Equal Sash / Full / TruScene®									
Unit No.	Dimensions (w x h)	White	Terratone	Sandtone	Forest Green	Canvas	Dark Bronze	Black	
18	WDH18210	19 7/8 x 34 27/32	1634603	2712203	1103401	0300303	9047903	9073254	9128596
	WDH1832	19 7/8 x 38 27/32	1634604	2712204	1103402	0300304	9047904	9073255	9128597
	WDH1836	19 7/8 x 42 27/32	1634660	2712260	1103550	0300360	9047959	9073310	9128652
	WDH18310	19 7/8 x 46 27/32	1634605	2712205	1103403	0300305	9047905	9073256	9128598
	WDH1842	19 7/8 x 50 27/32	1634606	2712206	1103404	0300306	9047906	9073257	9128599
	WDH1846	19 7/8 x 54 27/32	1634607	2712207	1103405	0300307	9047907	9073258	9128600
	WDH18410	19 7/8 x 58 27/32	1634661	2712261	1103551	0300361	9047960	9073311	9128653
	WDH1852	19 7/8 x 62 27/32	1634608	2712208	1103406	0300308	9047908	9073259	9128601
	WDH1856E	19 7/8 x 66 27/32	1634757	2712361	1103861	0300401	9047998	9073349	9128691
	WDH1856C	19 7/8 x 66 27/32	1634609	2712209	1103407	0300309	9047909	9073260	9128602
	WDH18510	19 7/8 x 70 27/32	1634662	2712262	1103552	0300362	9047961	9073312	9128654
	WDH1862	19 7/8 x 74 27/32	1634610	2712210	1103408	0300310	9047910	9073261	9128603
	WDH1872	19 7/8 x 88 27/32	1634758	2712392	1101592	0300240	9047881	9073232	9128574
WDH1876	19 7/8 x 90 27/32	1634759	2712393	1101593	0300241	9047882	9073233	9128575	
20	WDH20210	23 7/8 x 34 27/32	1634611	2712211	1103409	0300311	9047911	9073262	9128604
	WDH2032	23 7/8 x 38 27/32	1634612	2712212	1103410	0300312	9047912	9073263	9128605
	WDH2036	23 7/8 x 42 27/32	1634663	2712263	1103553	0300363	9047962	9073313	9128655
	WDH20310	23 7/8 x 46 27/32	1634613	2712213	1103411	0300313	9047913	9073264	9128606
	WDH2042	23 7/8 x 50 27/32	1634614	2712214	1103412	0300314	9047914	9073265	9128607
	WDH2046	23 7/8 x 54 27/32	1634615	2712215	1103413	0300315	9047915	9073266	9128608
	WDH20410	23 7/8 x 58 27/32	1634664	2712264	1103554	0300364	9047963	9073314	9128656
	WDH2052	23 7/8 x 62 27/32	1634616	2712216	1103414	0300316	9047916	9073267	9128609
	WDH2056E	23 7/8 x 66 27/32	1634760	2712362	1103862	0300402	9047999	9073350	9128692
	WDH2056C	23 7/8 x 66 27/32	1634617	2712217	1103415	0300317	9047917	9073268	9128610
	WDH20510	23 7/8 x 70 27/32	1634665	2712265	1103555	0300365	9047964	9073315	9128657
	WDH2062	23 7/8 x 74 27/32	1634618	2712218	1103416	0300318	9047918	9073269	9128611
	WDH2072	23 7/8 x 86 27/32	1634761	2712394	1101594	0300242	9047883	9073234	9128576
WDH2076	23 7/8 x 90 27/32	1634762	2712395	1101595	0300243	9047884	9073235	9128577	

Insect Screens

Insect Screen - Equal Sash / Full / TruScene®									
Unit No.	Dimensions (w x h)	White	Terratone	Sandtone	Forest Green	Canvas	Dark Bronze	Black	
24	WDH24210	27 7/8 × 34 27/32	1634619	2712219	1103417	0300319	9047919	9073270	9128612
	WDH2432	27 7/8 × 38 27/32	1634620	2712220	1103418	0300320	9047920	9073271	9128613
	WDH2436	27 7/8 × 42 27/32	1634666	2712266	1103556	0300366	9047965	9073316	9128658
	WDH24310	27 7/8 × 46 27/32	1634621	2712221	1103419	0300321	9047921	9073272	9128614
	WDH2442	27 7/8 × 50 27/32	1634622	2712222	1103420	0300322	9047922	9073273	9128615
	WDH2446	27 7/8 × 54 27/32	1634623	2712223	1103421	0300323	9047923	9073274	9128616
	WDH24410	27 7/8 × 58 27/32	1634667	2712267	1103557	0300367	9047966	9073317	9128659
	WDH2452	27 7/8 × 62 27/32	1634624	2712224	1103422	0300324	9047924	9073275	9128617
	WDH2456E	27 7/8 × 66 27/32	1634763	2712363	1103863	0300403	9048000	9073351	9128693
	WDH2456C	27 7/8 × 66 27/32	1634625	2712225	1103423	0300325	9047925	9073276	9128618
	WDH24510	27 7/8 × 70 27/32	1634668	2712268	1103558	0300368	9047967	9073318	9128660
	WDH2462	27 7/8 × 74 27/32	1634626	2712226	1103424	0300326	9047926	9073277	9128619
	WDH2466	27 7/8 × 78 27/32	OBD	OBD	OBD	OBD	OBD	OBD	OBD
	WDH2472	27 7/8 × 86 27/32	1634764	2712396	1101596	0300244	9047885	9073236	9128578
WDH2476	27 7/8 × 90 27/32	1634765	2712397	1101597	0300245	9047886	9073237	9128579	
26	WDH26210	29 7/8 × 34 27/32	1634669	2712269	1103559	0300369	9047968	9073319	9128661
	WDH2632	29 7/8 × 38 27/32	1634670	2712270	1103560	0300370	9047969	9073320	9128662
	WDH2636	29 7/8 × 42 27/32	1634671	2712271	1103561	0300371	9047970	9073321	9128663
	WDH26310	29 7/8 × 46 27/32	1634672	2712272	1103562	0300372	9047971	9073322	9128664
	WDH2642	29 7/8 × 50 27/32	1634673	2712273	1103563	0300373	9047972	9073323	9128665
	WDH2646	29 7/8 × 54 27/32	1634674	2712274	1103564	0300374	9047973	9073324	9128666
	WDH26410	29 7/8 × 58 27/32	1634675	2712275	1103565	0300375	9047974	9073325	9128667
	WDH2652	29 7/8 × 62 27/32	1634676	2712276	1103566	0300376	9047975	9073326	9128668
	WDH2656E	29 7/8 × 66 27/32	1634766	2712364	1103864	0300404	9048001	9073352	9128694
	WDH2656C	29 7/8 × 66 27/32	1634677	2712277	1103567	0300377	9047976	9073327	9128669
	WDH26510	29 7/8 × 70 27/32	1634678	2712278	1103568	0300378	9047977	9073328	9128670
	WDH2662	29 7/8 × 74 27/32	1634679	2712279	1103569	0300379	9047978	9073329	9128671
	WDH2672	29 7/8 × 86 27/32	1611296	2712398	1101598	0300246	9047887	9073238	9128580
	WDH2676	29 7/8 × 90 27/32	1611297	2712399	1101599	0300247	9047888	9073239	9128581

400 Series Woodwright® Double-Hung Windows (2002 to Present)

Standard Windows

Insect Screens

Insect Screen - Equal Sash / Full / TruScene®									
Unit No.	Dimensions (w x h)	White	Terratone	Sandtone	Forest Green	Canvas	Dark Bronze	Black	
28	WDH2828	31 7/8 x 32 27/32	OBD	OBD	OBD	OBD	OBD	OBD	OBD
	WDH28210	31 7/8 x 34 27/32	1634628	2712227	1103425	0300327	9047927	9073278	9128620
	WDH2832	31 7/8 x 38 27/32	1634629	2712228	1103426	0300328	9047928	9073279	9128621
	WDH2836	31 7/8 x 42 27/32	1634680	2712280	1103570	0300380	9047979	9073330	9128672
	WDH28310	31 7/8 x 46 27/32	1634630	2712229	1103427	0300329	9047929	9073280	9128622
	WDH2842	31 7/8 x 50 27/32	1634631	2712230	1103428	0300330	9047930	9073281	9128623
	WDH2846	31 7/8 x 54 27/32	1634632	2712231	1103429	0300331	9047931	9073282	9128624
	WDH28410	31 7/8 x 58 27/32	1634681	2712281	1103571	0300381	9047980	9073331	9128673
	WDH2852	31 7/8 x 62 27/32	1634633	2712232	1103430	0300332	9047932	9073283	9128625
	WDH2856E	31 7/8 x 66 27/32	1634767	2712365	1103865	0300405	9048002	9073353	9128695
	WDH2856C	31 7/8 x 66 27/32	1634634	2712233	1103431	0300333	9047933	9073284	9128626
	WDH28510	31 7/8 x 70 27/32	1634682	2712282	1103572	0300382	9047981	9073332	9128674
	WDH2862	31 7/8 x 74 27/32	1634635	2712234	1103432	0300334	9047934	9073285	9128627
	WDH2872	31 7/8 x 86 27/32	1634768	2712401	1102201	0300248	9047889	9073240	9128582
WDH2876	31 7/8 x 90 27/32	1634769	2712402	1102202	0300249	9047890	9073241	9128583	
210	WDH210210	33 7/8 x 34 27/32	1634683	2712283	1103573	0300383	9047982	9073333	9128675
	WDH21032	33 7/8 x 38 27/32	1634684	2712284	1103574	0300384	9047983	9073334	9128676
	WDH21036	33 7/8 x 42 27/32	1634685	2712285	1103575	0300385	9047984	9073335	9128677
	WDH210310	33 7/8 x 46 27/32	1634686	2712286	1103576	0300386	9047985	9073336	9128678
	WDH21042	33 7/8 x 50 27/32	1634687	2712287	1103577	0300387	9047986	9073337	9128679
	WDH21046	33 7/8 x 54 27/32	1634688	2712288	1103578	0300388	9047987	9073338	9128680
	WDH210410	33 7/8 x 58 27/32	1634689	2712289	1103579	0300389	9047988	9073339	9128681
	WDH21052	33 7/8 x 62 27/32	1634690	2712290	1103580	0300390	9047989	9073340	9128682
	WDH21056E	33 7/8 x 66 27/32	1634770	2712366	1103866	0300406	9048003	9073354	9128696
	WDH21056C	33 7/8 x 66 27/32	1634691	2712291	1103581	0300391	9047990	9073341	9128683
	WDH210510	33 7/8 x 70 27/32	1634692	2712292	1103582	0300392	9047991	9073342	9128684
	WDH21062	33 7/8 x 74 27/32	1634694	2712294	1103584	0300394	9047992	9073343	9128685
	WDH21072	33 7/8 x 86 27/32	1611298	2712409	1102209	0300256	9047897	9073248	9128590
WDH21076	33 7/8 x 90 27/32	1611299	2712410	1102210	0300257	9047898	9073249	9128591	

Insect Screens

Insect Screen - Equal Sash / Full / TruScene®									
Unit No.	Dimensions (w x h)	White	Terratone	Sandtone	Forest Green	Canvas	Dark Bronze	Black	
30	WDH30210	35 7/8 × 34 27/32	1634636	2712235	1103433	0300335	9047935	9073286	9128628
	WDH3032	35 7/8 × 38 27/32	1634637	2712236	1103434	0300336	9047936	9073287	9128629
	WDH3036	35 7/8 × 42 27/32	1634695	2712295	1103585	0300395	9047993	9073344	9128686
	WDH30310	35 7/8 × 46 27/32	1634638	2712237	1103435	0300337	9047937	9073288	9128630
	WDH3042	35 7/8 × 50 27/32	1634639	2712238	1103436	0300338	9047938	9073289	9128631
	WDH3046	35 7/8 × 54 27/32	1634640	2712239	1103437	0300339	9047939	9073290	9128632
	WDH3048	35 7/8 × 56 27/32	OBD	OBD	OBD	OBD	OBD	OBD	OBD
	WDH30410	35 7/8 × 58 27/32	1634696	2712296	1103586	0300396	9047994	9073345	9128687
	WDH3052	35 7/8 × 62 27/32	1634641	2712240	1103438	0300340	9047940	9073291	9128633
	WDH3056E	35 7/8 × 66 27/32	1634771	2712367	1103867	0300407	9048004	9073355	9128697
	WDH3056C	35 7/8 × 66 27/32	1634642	2712241	1103439	0300341	9047941	9073292	9128634
	WDH30510	35 7/8 × 70 27/32	1634697	2712297	1103587	0300397	9047995	9073346	9128688
	WDH3062	35 7/8 × 74 27/32	1634643	2712242	1103440	0300342	9047942	9073293	9128635
	WDH3072	35 7/8 × 86 27/32	1634772	2712403	1102203	0300250	9047891	9073242	9128584
WDH3076	35 7/8 × 90 27/32	1634773	2712404	1102204	0300251	9047892	9073243	9128585	
34	WDH34210	39 7/8 × 34 27/32	1634644	2712243	1103441	0300343	9047943	9073294	9128636
	WDH3432	39 7/8 × 38 27/32	1634645	2712244	1103442	0300344	9047944	9073295	9128637
	WDH3436	39 7/8 × 42 27/32	1634698	2712298	1103588	0300398	9047996	9073347	9128689
	WDH34310	39 7/8 × 46 27/32	1634646	2712245	1103443	0300345	9047945	9073296	9128638
	WDH3442	39 7/8 × 50 27/32	1634647	2712246	1103444	0300346	9047946	9073297	9128639
	WDH3446	39 7/8 × 54 27/32	1634648	2712247	1103445	0300347	9047947	9073298	9128640
	WDH34410	39 7/8 × 58 27/32	1634699	2712299	1103589	0300399	9047997	9073348	9128690
	WDH3452	39 7/8 × 62 27/32	1634649	2712248	1103446	0300348	9047948	9073299	9128641
	WDH3456E	39 7/8 × 66 27/32	1634774	2712368	1103868	0300408	9048005	9073356	9128698
	WDH3456C	39 7/8 × 66 27/32	1634650	2712249	1103447	0300349	9047949	9073300	9128642
	WDH34510	39 7/8 × 70 27/32	1611896	2710296	1103590	0300296	9047899	9073250	9128592
	WDH3462	39 7/8 × 74 27/32	1634651	2712250	1103448	0300350	9047950	9073301	9128643
	WDH3472	39 7/8 × 86 27/32	1634775	2712405	1102205	0300252	9047893	9073244	9128586
	WDH3476	39 7/8 × 90 27/32	1634776	2712406	1102206	0300253	9047894	9073235	9128587

400 Series Woodwright® Double-Hung Windows (2002 to Present)

Standard Windows

Insect Screens

Insect Screen - Equal Sash / Full / TruScene®									
Unit No.	Dimensions (w x h)	White	Terratone	Sandtone	Forest Green	Canvas	Dark Bronze	Black	
38	WDH38210	43 ⁷ / ₈ × 34 ²⁷ / ₃₂	1634652	2712251	1103449	0300351	9047951	9073302	9128644
	WDH3832	43 ⁷ / ₈ × 38 ²⁷ / ₃₂	1634653	2712252	1103450	0300352	9047952	9073303	9128645
	WDH3836	43 ⁷ / ₈ × 42 ²⁷ / ₃₂	1611897	2710297	1103591	0300297	9047900	9073251	9128593
	WDH38310	43 ⁷ / ₈ × 46 ²⁷ / ₃₂	1634654	2712253	1103451	0300353	9047953	9073304	9128646
	WDH3842	43 ⁷ / ₈ × 50 ²⁷ / ₃₂	1634655	2712254	1103452	0300354	9047954	9073305	9128647
	WDH3846	43 ⁷ / ₈ × 54 ²⁷ / ₃₂	1634656	2712255	1103453	0300355	9047955	9073306	9128648
	WDH38410	43 ⁷ / ₈ × 58 ²⁷ / ₃₂	1611898	2710298	1103592	0300298	9047901	9073252	9128594
	WDH3852	43 ⁷ / ₈ × 62 ²⁷ / ₃₂	1634657	2712256	1103454	0300356	9047956	9073307	9128649
	WDH3856E	43 ⁷ / ₈ × 66 ²⁷ / ₃₂	1634777	2712369	1103869	0300409	9048006	9073357	9128699
	WDH3856C	43 ⁷ / ₈ × 66 ²⁷ / ₃₂	1634658	2712257	1103455	0300357	9047957	9073308	9128650
	WDH38510	43 ⁷ / ₈ × 70 ²⁷ / ₃₂	1611899	2710299	1103593	0300299	9047902	9073253	9128595
	WDH3862	43 ⁷ / ₈ × 74 ²⁷ / ₃₂	1634659	2712258	1103456	0300358	9047958	9073309	9128651
	WDH3872	43 ⁷ / ₈ × 86 ²⁷ / ₃₂	1634778	2712407	1102207	0300254	9047895	9073246	9128588
	WDH3876	43 ⁷ / ₈ × 90 ²⁷ / ₃₂	1634779	2712408	1102208	0300255	9047896	9073247	9128589

Insect Screens

Insect Screens - Full / Standard

Note:

Standard size units use the same insect screens as 400 Series Tilt-Wash units (listed below). See 400 Series Tilt-Wash section for cottage insect screens. Insect screens for custom size windows are made to order. Half insect screens (see [page 49](#)) are made to order.

To order, state:

1. Description of Part (Full Insect Screen)
2. Quantity
3. Product ID (from product label, see [Service Guide 9051877](#))

Insect Screen - Equal Sash / Full / Standard

Unit No.	Dimensions (w x h)	White	Terratone	Sandtone	Forest Green	Canvas	Dark Bronze	Black	
18	WDH18210	19 ⁷ / ₈ × 34 ²⁷ / ₃₂	1610103	2710103	1139701	0313303	9048013	9073364	9128706
	WDH1832	19 ⁷ / ₈ × 38 ²⁷ / ₃₂	1610104	2710104	1139702	0313304	9048014	9073365	9128707
	WDH1836	19 ⁷ / ₈ × 42 ²⁷ / ₃₂	1610160	2710160	1139850	0313360	9048069	9073420	9128762
	WDH18310	19 ⁷ / ₈ × 46 ²⁷ / ₃₂	1610105	2710105	1139703	0313305	9048015	9073366	9128708
	WDH1842	19 ⁷ / ₈ × 50 ²⁷ / ₃₂	1610106	2710106	1139704	0313306	9048016	9073367	9128709
	WDH1846	19 ⁷ / ₈ × 54 ²⁷ / ₃₂	1610107	2710107	1139705	0313307	9048017	9073368	9128710
	WDH18410	19 ⁷ / ₈ × 58 ²⁷ / ₃₂	1610161	2710161	1139851	0313361	9048070	9073421	9128763
	WDH1852	19 ⁷ / ₈ × 62 ²⁷ / ₃₂	1610108	2710108	1139706	0313308	9048018	9073369	9128711
	WDH1856E	19 ⁷ / ₈ × 66 ²⁷ / ₃₂	1611057	2710461	1149061	0313501	9048131	9073482	9128801
	WDH1856C	19 ⁷ / ₈ × 66 ²⁷ / ₃₂	1610109	2710109	1139707	0313309	9048019	9073370	9128712
	WDH18510	19 ⁷ / ₈ × 70 ²⁷ / ₃₂	1610162	2710162	1139852	0313362	9048071	9073422	9128764
	WDH1862	19 ⁷ / ₈ × 74 ²⁷ / ₃₂	1610110	2710110	1139708	0313310	9048020	9073371	9128713
	WDH1872	19 ⁷ / ₈ × 88 ²⁷ / ₃₂	1611058	2700992	1100892	0300140	9047863	9073214	9128556
	WDH1876	19 ⁷ / ₈ × 90 ²⁷ / ₃₂	1611059	2700993	1100893	0300141	9047864	9073215	9128557

400 Series Woodwright® Double-Hung Windows (2002 to Present)

Standard Windows

Insect Screens

Insect Screen - Equal Sash / Full / Standard									
Unit No.	Dimensions (w x h)	White	Terratone	Sandtone	Forest Green	Canvas	Dark Bronze	Black	
20	WDH20210	23 7/8 x 34 27/32	1610111	2710111	1139709	0313311	9048021	9073372	9128714
	WDH2032	23 7/8 x 38 27/32	1610112	2710112	1139710	0313312	9048022	9073373	9128715
	WDH2036	23 7/8 x 42 27/32	1610163	2710163	1139853	0313363	9048072	9073423	9128765
	WDH20310	23 7/8 x 46 27/32	1610113	2710113	1139711	0313313	9048023	9073374	9128716
	WDH2042	23 7/8 x 50 27/32	1610114	2710114	1139712	0313314	9048024	9073375	9128717
	WDH2046	23 7/8 x 54 27/32	1610115	2710115	1139713	0313315	9048025	9073376	9128718
	WDH20410	23 7/8 x 58 27/32	1610164	2710164	1139854	0313364	9048073	9073424	9128766
	WDH2052	23 7/8 x 62 27/32	1610116	2710116	1139714	0313316	9048026	9073377	9128719
	WDH2056E	23 7/8 x 66 27/32	1611060	2710462	1149062	0313502	9048132	9073483	9128802
	WDH2056C	23 7/8 x 66 27/32	1610117	2710117	1139715	0313317	9048027	9073378	9128720
	WDH20510	23 7/8 x 70 27/32	1610165	2710165	1139855	0313365	9048074	9073425	9128767
	WDH2062	23 7/8 x 74 27/32	1610118	2710118	1139716	0313198	9048028	9073379	9128721
	WDH2072	23 7/8 x 86 27/32	1611061	2700994	1100894	0300142	9047865	9073216	9128558
WDH2076	23 7/8 x 90 27/32	1611062	2700995	1100895	0300143	9047866	9073217	9128559	
24	WDH24210	27 7/8 x 34 27/32	1610119	2710119	1139717	0313319	9048029	9073380	9128722
	WDH2432	27 7/8 x 38 27/32	1610120	2710120	1139718	0313320	9048030	9073381	9128723
	WDH2436	27 7/8 x 42 27/32	1610166	2710166	1139856	0313366	9048075	9073426	9128768
	WDH24310	27 7/8 x 46 27/32	1610121	2710121	1139719	0313321	9048031	9073382	9128724
	WDH2442	27 7/8 x 50 27/32	1610122	2710122	1139720	0313322	9048032	9073383	9128725
	WDH2446	27 7/8 x 54 27/32	1610123	2710123	1139721	0313323	9048033	9073384	9128726
	WDH24410	27 7/8 x 58 27/32	1610167	2710167	1139857	0313367	9048076	9073427	9128769
	WDH2452	27 7/8 x 62 27/32	1610124	2710124	1139722	0313324	9048034	9073385	9128727
	WDH2456E	27 7/8 x 66 27/32	1611063	2710463	1149063	0313503	9048133	9073484	9128803
	WDH2456C	27 7/8 x 66 27/32	1610125	2710125	1139723	0313325	9048035	9073386	9128728
	WDH24510	27 7/8 x 70 27/32	1610168	2710168	1139858	0313368	9048077	9073428	9128770
	WDH2462	27 7/8 x 74 27/32	1610126	2710126	1139724	0313326	9048036	9073387	9128729
	WDH2466	27 7/8 x 78 27/32	1610127	OBD	OBD	OBD	OBD	OBD	OBD
WDH2472	27 7/8 x 86 27/32	1611064	2700996	1100896	0300144	9047867	9073218	9128560	
WDH2476	27 7/8 x 90 27/32	1611065	1100897	1100897	0300145	9047868	9073219	9128561	

Insect Screens

Insect Screen - Equal Sash / Full / Standard									
Unit No.	Dimensions (w x h)	White	Terratone	Sandtone	Forest Green	Canvas	Dark Bronze	Black	
26	WDH26210	29 7/8 x 34 27/32	1610169	2710169	1139859	0313369	9048078	9073429	9128771
	WDH2632	29 7/8 x 38 27/32	1610170	2710170	1139860	0313370	9048079	9073430	9128772
	WDH2636	29 7/8 x 42 27/32	1610171	2710171	1139861	0313371	9048080	9073431	9128773
	WDH26310	29 7/8 x 46 27/32	1610172	2710172	1139862	0313372	9048081	9073432	9128774
	WDH2642	29 7/8 x 50 27/32	1610173	2710173	1139863	0313373	9048082	9073433	9128775
	WDH2646	29 7/8 x 54 27/32	1610174	2710174	1139864	0313374	9048083	9073434	9128776
	WDH26410	29 7/8 x 58 27/32	1610175	2710175	1139865	0313375	9048084	9073435	9128777
	WDH2652	29 7/8 x 62 27/32	1610176	2710176	1139866	0313376	9048085	9073436	9128778
	WDH2656E	29 7/8 x 66 27/32	1611066	2710464	1149064	0313504	9048134	9073485	9128804
	WDH2656C	29 7/8 x 66 27/32	1610177	2710177	1139867	0313377	9048086	9073437	9128779
	WDH26510	29 7/8 x 70 27/32	1610178	2710178	1139868	0313378	9048087	9073438	9128780
	WDH2662	29 7/8 x 74 27/32	1610179	2710179	1139869	0313379	9048088	9073439	9128781
	WDH2672	29 7/8 x 86 27/32	1600696	2700998	1100898	0300146	9047869	9073220	9128562
WDH2676	29 7/8 x 90 27/32	1600697	2700999	1100899	0300147	9047870	9073221	9128563	
28	WDH2828	31 7/8 x 32 27/32	1610101	2710101	OB	0313301	9048011	9073362	9128704
	WDH28210	31 7/8 x 34 27/32	1610128	2710127	1139725	0313327	9048037	9073388	9128730
	WDH2832	31 7/8 x 38 27/32	1610129	2710128	1139726	0313328	9048038	9073389	9128731
	WDH2836	31 7/8 x 42 27/32	1610180	2710180	1139870	0313380	9048089	9073440	9128782
	WDH28310	31 7/8 x 46 27/32	1610130	2710129	1139727	0313329	9048039	9073390	9128732
	WDH2842	31 7/8 x 50 27/32	1610131	2710130	1139728	0313330	9048040	9073391	9128733
	WDH2846	31 7/8 x 54 27/32	1610132	2710131	1139729	0313331	9048041	9073392	9128734
	WDH28410	31 7/8 x 58 27/32	1610181	2710181	1139871	0313381	9048090	9073441	9128783
	WDH2852	31 7/8 x 62 27/32	1610133	2710132	1139730	0313332	9048042	9073393	9128735
	WDH2856E	31 7/8 x 66 27/32	1611067	2710465	1149065	0313505	9048135	9073486	9128805
	WDH2856C	31 7/8 x 66 27/32	1610134	2710133	1139731	0313333	9048043	9073394	9128736
	WDH28510	31 7/8 x 70 27/32	1610182	2710182	1139872	0313382	9048091	9073442	9128784
	WDH2862	31 7/8 x 74 27/32	1610135	2710134	1139732	0313334	9048044	9073395	9128737
	WDH2872	31 7/8 x 86 27/32	1611068	2701001	1100901	0300148	9047871	9073222	9128564
WDH2876	31 7/8 x 90 27/32	1611069	2701002	1100902	0300149	9047872	9073223	9128565	

400 Series Woodwright® Double-Hung Windows (2002 to Present)

Standard Windows

Insect Screens

Insect Screen - Equal Sash / Full / Standard									
Unit No.	Dimensions (w x h)	White	Terratone	Sandtone	Forest Green	Canvas	Dark Bronze	Black	
210	WDH210210	33 7/8 x 34 27/32	1610183	2710183	1139873	0313383	9048092	9073443	9128785
	WDH21032	33 7/8 x 38 27/32	1610184	2710184	1139874	0313384	9048093	9073444	9128786
	WDH21036	33 7/8 x 42 27/32	1610185	2710185	1139875	0313385	9048094	9073445	9128787
	WDH210310	33 7/8 x 46 27/32	1610186	2710186	1139876	0313386	9048095	9073446	9128788
	WDH21042	33 7/8 x 50 27/32	1610187	2710187	1139877	0313387	9048096	9073447	9128789
	WDH21046	33 7/8 x 54 27/32	1610188	2710188	1139878	0313388	9048097	9073448	9128790
	WDH210410	33 7/8 x 58 27/32	1610189	2710189	1139879	0313389	9048098	9073449	9128791
	WDH21052	33 7/8 x 62 27/32	1610190	2710190	1139880	0313390	9048099	9073450	9128792
	WDH21056E	33 7/8 x 66 27/32	1611070	2710466	1149066	0313506	9048136	9073487	9128806
	WDH21056C	33 7/8 x 66 27/32	1610191	2710191	1139881	0313391	9048100	9073451	9128793
	WDH210510	33 7/8 x 70 27/32	1610192	2710192	1139882	0313392	9048101	9073452	9128794
	WDH21062	33 7/8 x 74 27/32	1610194	2710194	1139884	0313394	9048102	9073453	9128795
	WDH21072	33 7/8 x 86 27/32	1600698	2701009	1100909	0300156	9047879	9073230	9128572
WDH21076	33 7/8 x 90 27/32	1600699	2701010	1100910	0300157	9047880	9073231	9128573	
30	WDH30210	35 7/8 x 34 27/32	1610136	2710135	1139733	0313335	9048045	9073396	9128738
	WDH3032	35 7/8 x 38 27/32	1610137	2710136	1139734	0313336	9048046	9073397	9128739
	WDH3036	35 7/8 x 42 27/32	1610195	2710195	1139885	0313395	9048103	9073454	9128796
	WDH30310	35 7/8 x 46 27/32	1610138	2710137	1139735	0313337	9048047	9073398	9128740
	WDH3042	35 7/8 x 50 27/32	1610139	2710138	1139736	0313338	9048048	9073399	9128741
	WDH3046	35 7/8 x 54 27/32	1610140	2710139	1139737	0313339	9048049	9073400	9128742
	WDH3048	35 7/8 x 56 27/32	OBD	2710102	OBD	0313302	9048012	9073363	9128705
	WDH30410	35 7/8 x 58 27/32	1610196	2710196	1139886	0313396	9048104	9073455	9128797
	WDH3052	35 7/8 x 62 27/32	1610141	2710140	1139738	0313340	9048050	9073401	9128743
	WDH3056E	35 7/8 x 66 27/32	1611071	2710467	1149067	0313507	9048137	9073488	9128807
	WDH3056C	35 7/8 x 66 27/32	1610142	2710141	1139739	0313341	9048051	9073402	9128744
	WDH30510	35 7/8 x 70 27/32	1610197	2710197	1139887	0313397	9048105	9073456	9128798
	WDH3062	35 7/8 x 74 27/32	1610143	2710142	1139740	0313342	9048052	9073403	9128745
WDH3072	35 7/8 x 86 27/32	1611072	2701003	1100903	0300150	9047873	9073224	9128566	
WDH3076	35 7/8 x 90 27/32	1611073	2701004	1100904	0300151	9047874	9073525	9128567	

Insect Screens

Insect Screen - Equal Sash / Full / Standard									
Unit No.	Dimensions (w x h)	White	Terratone	Sandtone	Forest Green	Canvas	Dark Bronze	Black	
34	WDH34210	39 7/8 × 34 27/32	1610144	2710143	1139741	0313343	9048053	9073404	9128746
	WDH3432	39 7/8 × 38 27/32	1610145	2710144	1139742	0313344	9048054	9073405	9128747
	WDH3436	39 7/8 × 42 27/32	1610198	2710198	1139888	0313398	9048106	9073457	9128799
	WDH34310	39 7/8 × 46 27/32	1610146	2710145	1139743	0313345	9048055	9073406	9128748
	WDH3442	39 7/8 × 50 27/32	1610147	2710146	1139744	0313346	9048056	9073407	9128749
	WDH3446	39 7/8 × 54 27/32	1610148	2710147	1139745	0313347	9048057	9073408	9128750
	WDH34410	39 7/8 × 58 27/32	1610199	2710199	1139889	0313399	9048107	9073458	9128800
	WDH3452	39 7/8 × 62 27/32	1610149	2710148	1139746	0313348	9048058	9073409	9128751
	WDH3456E	39 7/8 × 66 27/32	1611074	2710468	1149068	0313508	9048138	9073489	9128808
	WDH3456C	39 7/8 × 66 27/32	1610150	2710149	1139747	0313349	9048059	9073410	9128752
	WDH34510	39 7/8 × 70 27/32	1610096	2710096	1139890	0313296	9048007	9073358	9128700
	WDH3462	39 7/8 × 74 27/32	1610151	2710150	1139748	0313350	9048060	9073411	9128753
	WDH3472	39 7/8 × 86 27/32	1611075	2701005	1100905	0300152	9047875	9073226	9128568
WDH3476	39 7/8 × 90 27/32	1611076	2701006	1100906	0300153	9047876	9073227	9128569	
38	WDH38210	43 7/8 × 34 27/32	1610152	2710151	1139749	0313351	9048061	9073412	9128754
	WDH3832	43 7/8 × 38 27/32	1610153	2710152	1139750	0313352	9048062	9073413	9128755
	WDH3836	43 7/8 × 42 27/32	1610097	2710097	1139891	0313297	9048008	9073359	9128701
	WDH38310	43 7/8 × 46 27/32	1610154	2710153	1139751	0313353	9048063	9073414	9128756
	WDH3842	43 7/8 × 50 27/32	1610155	2710154	1139752	0313354	9048064	9073415	9128757
	WDH3846	43 7/8 × 54 27/32	1610156	2710155	1139753	0313355	9048065	9073416	9128758
	WDH38410	43 7/8 × 58 27/32	1610098	2710098	1139892	0313298	9048009	9073360	9128702
	WDH3852	43 7/8 × 62 27/32	1610157	2710156	1139754	0313356	9048066	9073417	9128759
	WDH3856E	43 7/8 × 66 27/32	1611077	2710469	1149069	0313509	9048139	9073490	9128809
	WDH3856C	43 7/8 × 66 27/32	1610158	2710157	1139755	0313357	9048067	9073418	9128760
	WDH38510	43 7/8 × 70 27/32	1610099	2710099	1139893	0313299	9048010	9073361	9128703
	WDH3862	43 7/8 × 74 27/32	1610159	2710158	1139756	0313358	9048068	9073419	9128761
	WDH3872	43 7/8 × 86 27/32	1611078	2701007	1100907	0300154	9047877	9073228	9128570
WDH3876	43 7/8 × 90 27/32	1611079	2701008	1100908	0300155	9047878	9073229	9128571	

400 Series Woodwright® Double-Hung Windows (2002 to Present)

Standard Windows

Insect Screens

Insect Screens - Half / Standard

Insect Screen - Half

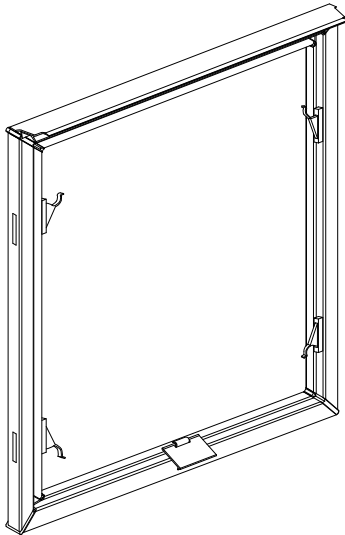

Note:

Half screen replacements are made to order. Includes [bug seal](#). See [Accessory Guide 0005376](#).

To order, state:

1. Description of Part (Half Screen)
2. Quantity
3. Product ID (from product label, see [Service Guide 9051877](#))

Bug Seal - Insect Screen - Half

Bug Seal Assembly - Insect Screen - Half

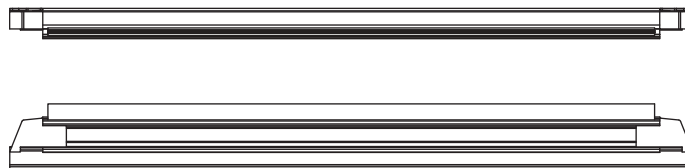

Unit No.	Length	White	Terratone	Sandtone	Forest Green	Canvas	Dark Bronze	Black
18	19 ³ / ₄	1693408	2791255	1191304	0381355	9076687	9076919	9129179
20	23 ³ / ₄	1693409	2791256	1191305	0381356	9076688	9076920	9129180
24	27 ³ / ₄	1693410	2791257	1191306	0381357	9076689	9076921	9129181
26	29 ³ / ₄	1693411	2791258	1191307	0381358	9076690	9076922	9129182
28	31 ³ / ₄	1693412	2791259	1191308	0381359	9076691	9076923	9129183
210	33 ³ / ₄	1693413	2791260	1191309	0381360	9076692	9076924	9129184
30	35 ³ / ₄	1693414	2791261	1191310	0381361	9076693	9076925	9129185
34	39 ³ / ₄	1693415	2791262	1191311	0381362	9076694	9076926	9129186
38	43 ³ / ₄	1693416	2791263	1191312	0381363	9076695	9076927	9129187

Insect Screens

Insect Screen Hardware			
Screen Lock with Housing (Pair)			
	Note: The originals are hard to replace. No instructions are provided. Consider a replacement screen instead.	Color Order No.	
		White	1693417
		Terratone	2791264
		Sandtone	1191313
		Forest Green	0381364
		Canvas	9014568
Dark Bronze	9076928		

Finger Pull - Insect Screen / Full		
		Order No. 8121701
	Screen Label with Clip	
		Order No. 1631110
	Retractable Screen Pull (7/2023 to Present)	
	Note: See Service Instructions, Insect Screen Pull Tab Replacement 9203873 .	Order No. 9199627

400 Series Woodwright® Double-Hung Windows (2002 to Present)

Standard Windows

Grilles

Interior Grilles

Note:

Grilles include fasteners. Replacement finelight grilles, high-definition grilles, and exterior grilles are available as part of a replacement sash only. To order, see upper or lower sash, [page 12](#).

Removable Interior Grilles

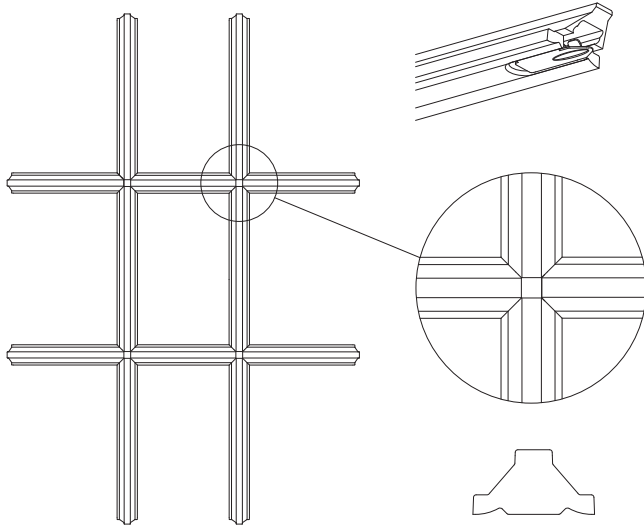

Note:

Removable interior grilles are made to order. See [Accessory Guide 005285](#). See [Replacement Video](#).

To order, state:

1. Description of Part (Removable Interior Grilles)
2. Quantity
3. Product ID (from product label, see [Service Guide 9051877](#))

Interior Grille Parts

Interior Grille Clip Kit (Prior to 2004)



Note:

Clip affixes to wood grille.

Finish	Order No.
White	0873284
Terratone®	N/A
Sandtone	0873285
Forest Green	N/A

Interior Grille Clip (2004 to Present)

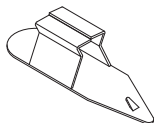

Note:

Secures to sash. Quantity of one clip.

Finish	Order No.
White	0174951
Terratone®	0174952
Sandtone	0174953
Forest Green	0174955
Canvas	0174954
Dark Bronze	9020288
Black	9010539

Combination Unit

Combination Unit - Double Hung

Note:

The Double-Hung Combination unit can be used on the full frame Woodwright® unit.

Frames

Frame Assembly

Note:

See latest [Product Details](#).

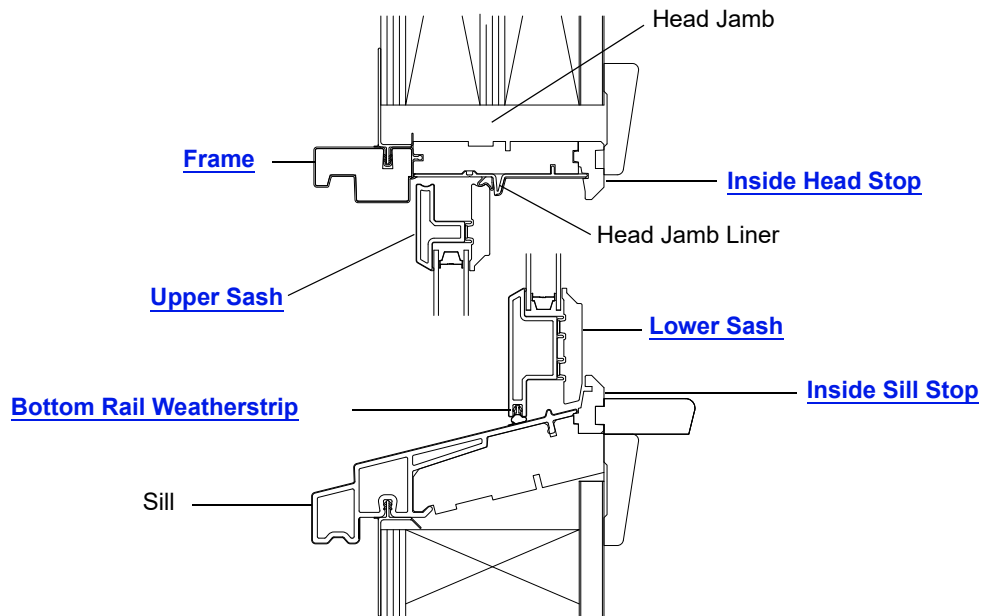
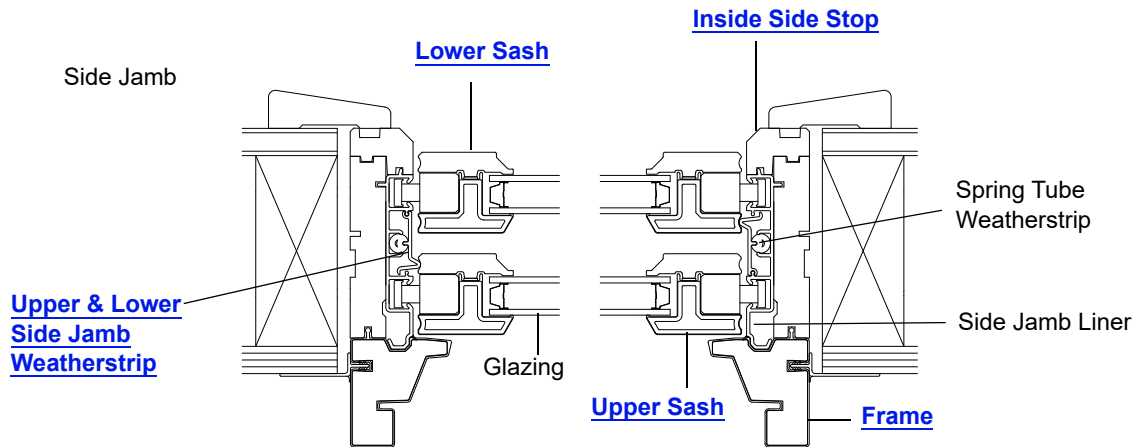

Woodwright® Double-Hung Frame Assembly

Frames

Frames

Frame

Note:

Replacement frames are made to order. Frame ships with head jamb liner, jamb liners and inside stops. Balancers not included.

To order, state:

1. **Description of Part (Complete Frame)**
2. **Quantity**
3. **Product ID (from product label, see [Service Guide 9051877](#))**



400 Series Woodwright® Double-Hung Windows (2002 to Present)

Standard Windows

Frames

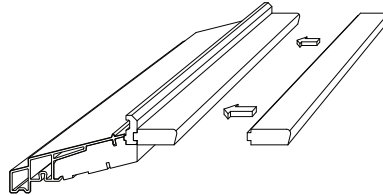
Stools



Stool - Mull											
Single						Double					
Unit No.	Length					Unit No.	Length				
		Natural Wood Interior		Prefinished White Interior				Natural Wood Interior		Prefinished White Interior	
		4 9/16"	6 9/16"	4 9/16"	6 9/16"			4 9/16"	6 9/16"	4 9/16"	6 9/16"
WDH/18	27	1613660	1613750	1617760	1630860	WDH/18-2	48 1/2	1613670	1613757	1617770	1630870
WDH/20	31	1613661	1613751	1617761	1630861	WDH/20-2	56 1/2	1613671	1613758	1617771	1630871
WDH/24	35	1613662	1613752	1617762	1630862	WDH/24-2	64 1/2	1613672	1613759	1617772	1630872
WDH/26	37	1613658	1613771	1617758	1630849	WDH/26-2	68 1/2	1613677	1613773	1617777	1630877
WDH/28	39	1613663	1613753	1617763	1630863	WDH/28-2	72 1/2	1613673	1613760	1617773	1630873
WDH/210	41	1613659	1613772	1617759	1630858	WDH/210-2	76 1/2	1613678	1613774	1617778	1630878
WDH/30	43	1613664	1613754	1617764	1630864	WDH/30-2	80 1/2	1613674	1613761	1617774	1630874
WDH/34	47	1613665	1613755	1617765	1630865	WDH/34-2	88 1/2	1613675	1613762	1617775	1630875
WDH/38	51	1613666	1613756	1617766	1630866	WDH/38-2	96 1/2	1613676	1613763	1617776	1630876
Triple											
Unit No.	Length										
		Natural Wood Interior		Prefinished White Interior							
		4 9/16"	6 9/16"	4 9/16"	6 9/16"						
WDH/18-3	69 15/16	1613680	1613764	1617780	1630880						
WDH/20-3	81 15/16	1613681	1613765	1617781	1630881						
WDH/24-3	93 15/16	1613682	1613766	1617782	1630882						
WDH/26-3	102 15/16	1613687	1613775	1617787	1630887						
WDH/28-3	105 15/16	1613683	1613767	1617783	1630883						
WDH/210-3	111 15/16	1613688	1613776	1617788	1630888						
WDH/30-3	117 15/16	1613684	1613768	1617784	1630884						
WDH/34-3	129 15/16	1613685	1613769	1617785	1630885						
WDH/38-3	141 15/16	1613686	1613770	1617786	1630886						

Frames

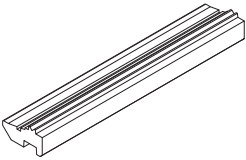
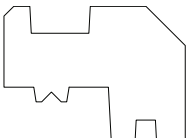
Inside Stops				
Inside Stop - Head and Sill				
	Note: Cut to length for specific application.	Length 55 1/2	Finish Pine	Order No. 0102710
			Maple	0102720
			Oak	0102719
			Prefinished White Interior	0102718
Inside Stop - Side				
	Note: Replacement inside side stops are made to order. To order, state: <ol style="list-style-type: none"> Description of Part (Inside Stop - side) Quantity Product ID (from product label, see Service Guide 9051877) 			

400 Series Woodwright® Double-Hung Windows (2002 to Present)

Standard Windows

Frames

Extension Jamb

Note:

Replacement arch extension jambs are made to order. See [Accessory Guide 9000406](#).

To order, state:

1. Description of Part (arch extension jamb)
2. Quantity
3. Product ID (from product label, see [Service Guide 9051877](#))
4. Options desired (if different than original)

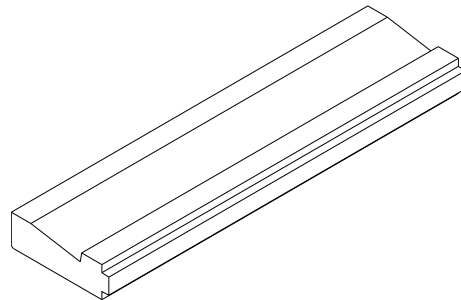

Extension Jamb - Standard Window / Head/Sill/Side / Pine

Length	5 1/4"	6 9/16"	7 1/8"
96	1636627	1636637	1636647
144	1636628	1636638	1636648

Extension Jamb - Standard Window / Head/Sill/Side / Maple

Length	5 1/4"	6 9/16"	7 1/8"
72	0102573	0102576	0102579
96	0102574	0102577	0102580
144	0102575	0102578	0102581

Extension Jamb - Standard Window / Head/Sill/Side / Oak

Length	5 1/4"	6 9/16"	7 1/8"
72	0102564	0102567	0102570
96	0102565	0102568	0102571
144	0102566	0102569	0102572

Extension Jamb - Standard Window / Head/Sill/Side / Prefinished White Interior

Length	5 1/4"	6 9/16"	7 1/8"
72	0102582	0102585	0102588
96	0102583	0102586	0102589
144	0102584	0102587	0102590

Frames

Flange

Note:
Cut to size if necessary.

Nailing Flange - Side (Pair)

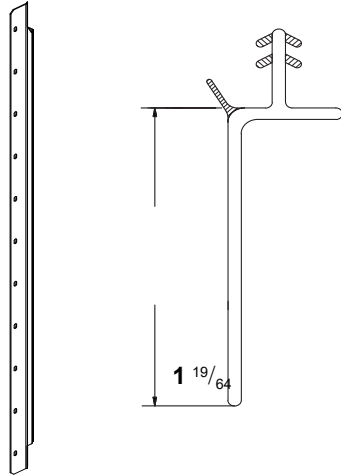

Unit No.	Dimensions	Order No.
WDH/210	38 ²¹ / ₆₄	1635020
WDH/32	42 ²¹ / ₆₄	1635021
WDH/310	50 ²¹ / ₆₄	1635023
WDH/42	54 ²¹ / ₆₄	1635024
WDH/46	58 ²¹ / ₆₄	1635025
WDH/52	66 ²¹ / ₆₄	1635027
WDH/56	70 ²¹ / ₆₄	1635028
WDH/62	78 ²¹ / ₆₄	1635030

Nailing Flange - Head and Sill

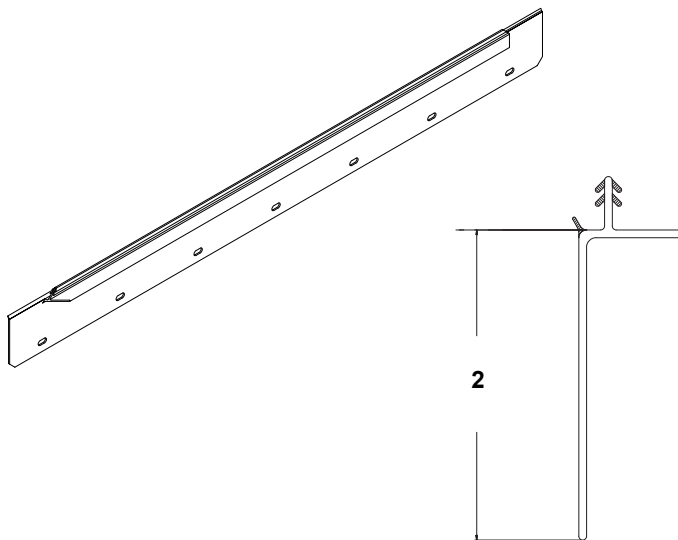



Unit No.	Dimensions	Order No.
WDH/18	23 ¹⁵ / ₁₆	1625460
WDH/20	27 ¹⁵ / ₁₆	1625461
WDH/24	31 ¹⁵ / ₁₆	1625462
WDH/28	35 ¹⁵ / ₁₆	1625463
WDH/30	39 ¹⁵ / ₁₆	1625464
WDH/34	43 ¹⁵ / ₁₆	1625465
WDH/38	47 ¹⁵ / ₁₆	1625466

400 Series Woodwright® Double-Hung Windows (2002 to Present)

Standard Windows

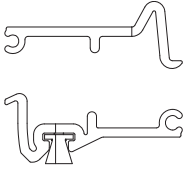
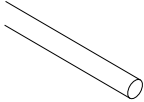
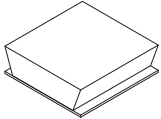
Frames

Weatherstrip			
Weatherstrip - Upper/Lower Side Jamb			
	<p>Note: Upper/Lower side jamb weatherstrip for standard and custom size windows are made to order. Upper weatherstrip has no felt weatherstrip; lower weatherstrip has felt weatherstrip applied (after 2/07). Order one pair (LH and RH).</p> <p><i>To order, state:</i></p> <ol style="list-style-type: none"> Description of Part (Upper/Lower side jamb weatherstrip) Species/Finish (Pine, Oak, Maple, White) Quantity (Pair) Product ID (from product label, see Service Guide 9051877) 		
Weatherstrip			
	<p>Note: Orange in color and used behind side jamb liner. Called spring tube weatherstrip in frame cross section.</p>	<p>Length 10 ft.</p>	<p>Order No. 0102612</p>
Weatherstrip - Dust Plug			
		<p>Order No. 0102623</p>	
Weatherstrip - Fin-Pile			
	<p>Note: Used on lower side jamb assembly.</p>	<p>Length Order by the foot</p>	<p>Order No. 9056123</p>

Frames

Misc Frame Parts

Side Jamb Clip

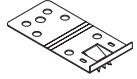
		Order No.
		1630908

Cap - Woodwright® / Sill End

		Color	Left	Right
		White	3464802	3464803
		Terratone®	3464804	3464805
		Sandtone	3464806	3464807
		Forest Green	3467005	3467006
		Canvas	9047368	9047369
		Dark Bronze	9073804	9073805
		Black	9127233	9127234

Liner Plug - Side and Sill

		Gray
		0102708

Chimney Plug - Foam

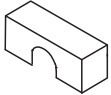
		Gray
		9131658

Bumpers

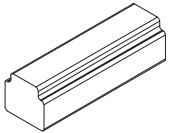
		Finish	Order No.
		White	9019610
		Stone	9019611

Rods

	Finish	Order No.
	White	9019606
	Stone	9019608

400 Series Woodwright® Double-Hung Windows (2002 to Present)

Standard Windows

Frames

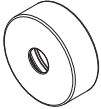
Vent Limiter Kit			
	Kit Includes: (20) Bumpers (20) Fasteners Installation Guide 0005510	Type	Order No.
		Commercial	0102096
		Residential	0102095

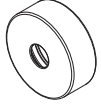
Limited Travel Bumper		
	Note: Use to replace all previous vintage bumpers. Also order screws, 0112045 . Both ship as a package of two.	Package of 2
		0112044

Installation Kit		
Installation Kit - Windows		
Note: Used for rectangular openings up to 46" x 72". See Installation Guide 9080775 .		
	Kit Includes: Backer Rod Shims Fasteners Flashing Tape Insulating Foam Sealant Installation Guide	Order No.
		9080773

Joining Components

Narrow Mullion Kits

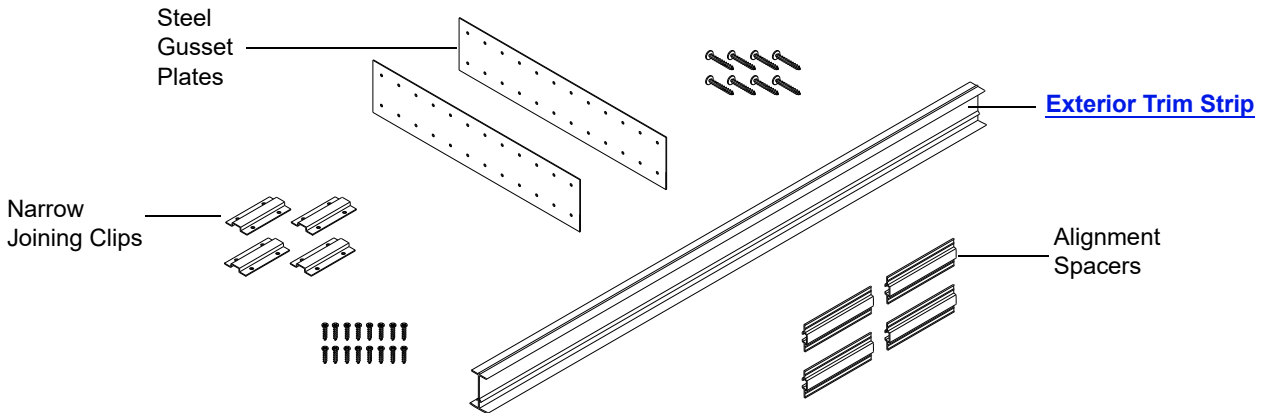

Joining Kit - Transom Window / Narrow Mullion

Kit Includes:

Joining clips, gusset plates, exterior trim strip, alignment spacers, and screws

Length	White	Terratone	Sandtone	Forest Green	Canvas	Dark Bronze	Black
48	0102597	0102602	0102599	0102604	9076727	9076959	9138790
84	0102598	0102603	0102601	0102605	9073728	9076960	9138791
150	0102615	0102617	0102616	0102618	9076729	9076961	9138792

Joining Kits - Vertical / Narrow Mullion

Kit Includes:

Outside mull vertical trim, head gusset plate, sill gusset plate, narrow mullion clip, wide mull joining trim flashing, narrow mull alignment spacer. Inside [mull casing](#) is sold separately.

Unit No.	Length	White	Terratone	Sandtone	Forest Green	Canvas	Dark Bronze	Black
TW210	36 ³ / ₄	1612001	2711501	1141401	0312801	9069375	9077095	9129486
TW32	40 ³ / ₄	1612002	2711502	1141402	0312802	9069376	9077096	9129487
TW36	44 ³ / ₄	1612003	2711503	1141403	0312803	9069377	9077097	9129488
TW310	48 ³ / ₄	1612004	2711504	1141404	0312804	9069378	9077098	9129489
TW42	52 ³ / ₄	1612005	2711505	1141405	0312805	9069379	9077099	9129490
TW46	56 ³ / ₄	1612006	2711506	1141406	0312806	9069380	9077100	9129491
TW410	60 ³ / ₄	1612007	2711507	1141407	0312807	9069381	9077101	9129492
TW52	64 ³ / ₄	1612008	2711508	1141408	0312808	9069382	9077102	9129493
TW56	68 ³ / ₄	1612009	2711509	1141409	0312809	9069383	9077103	9129494
TW510	72 ³ / ₄	1612010	2711510	1141410	0312810	9069384	9077104	9129495
TW62	76 ³ / ₄	1612011	2711511	1141411	0312811	9069385	9077105	9129496

400 Series Woodwright® Double-Hung Windows (2002 to Present)

Standard Windows

Joining Components

Narrow Mullion Kit Components

Exterior Trim Strip - Vertical Mullion

Note:

See [Joining Guide 0005368](#) for trim strip details used on vertical mulls.

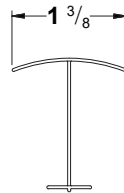

Unit No.	Length	White	Terra-tone	Sand-tone	Forest Green	Canvas	Dark Bronze	Black
TW210	36 3/4	1632915	2741715	1142415	0331786	9053166	9074039	9129254
TW32	40 3/4	1632916	2741716	1142416	0331787	9053167	9074040	9129255
TW36	44 3/4	1632917	OBD	1142417	OBD	9053168	9074041	9129321
TW310	48 3/4	1632918	2741718	1142418	0331789	9053169	9074042	9129256
TW42	52 3/4	1632919	2741719	1142419	0331790	9053170	9074043	9129257
TW46	56 3/4	1632920	2741720	1142420	0331791	9053171	9074044	9129322
TW410	60 3/4	1632921	OBD	1142421	OBD	9053172	9074045	9129323
TW52	64 3/4	1632922	2741722	1142422	0331793	9053173	9074046	9129324
TW56	68 3/4	1632923	2741723	1142423	0331794	9053174	9074047	9129258
TW510	72 3/4	1632924	OBD	1142424	OBD	9053175	9074048	OBD
TW62	76 3/4	1632925	2741725	1142425	0331796	9053176	9074049	9129259
150 in	150	1632926	2741726	1142426	0331797	9053177	9073178	9129320

Mull Trim - Narrow Mullion

Note:

See [Joining Guide 0004378](#) for trim strip details used on horizontal mulls.

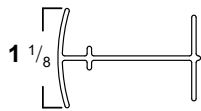

Length	White	Terra-tone	Sand-tone	Forest Green	Canvas	Dark Bronze	Black
48	0102713	0102726	0102725	0102727	9076696	9076929	9133084
84	0102728	0102730	0102729	0102731	9076697	9076930	9133085
150	0102732	0102734	0102733	0102735	9076698	9076931	9130022

Exterior Flashing - Narrow Mullion

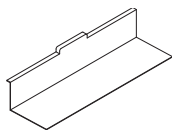

Length	White	Terra-tone	Sand-tone	Forest Green	Canvas	Dark Bronze	Black
	1642108	2742108	1152902	0331798	9033568	9073179	9127235

Inside Casing - Narrow Mullion

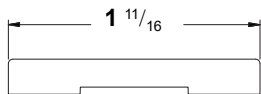

Length	Pine	Maple	Oak	Prefin-ished White	Forest Green	Canvas	Dark Bronze	Black
72	-	0102593	0102591	0102595	-	-	-	-
73 7/32	1611557	-	-	-	-	-	-	-
96	0112060	0102594	0102592	0102596	-	-	-	-
120	-	-	-	-	9173235	9173236	9173237	9173238

Joining Components

Support Mullion Kits

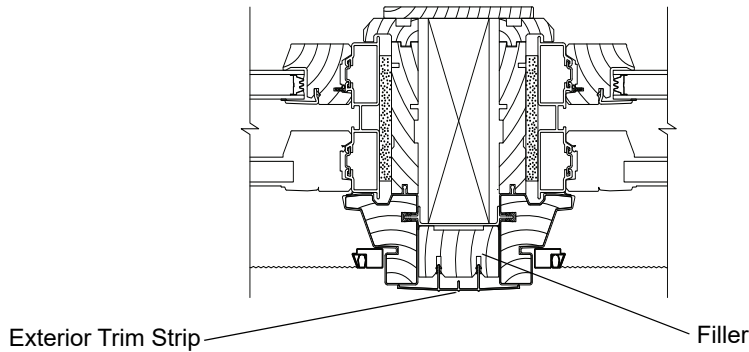

Woodwright® Double-Hung Support Mullion

Joining Kit - Support Mullion / TW / DHP / NL to TW / DHP / NL								
Unit No.	Length	White	Terratone	Sandtone	Forest Green	Canvas	Dark Bronze	Black
WDH210	36 3/4	1611570	2712520	1141202	0312920	9069386	9077106	9129497
WDH32	40 3/4	1611571	2712524	1141204	0312924	9069387	9077107	9129498
WDH36	44 3/4	1611515	9051558	9051559	9051560	9069388	9077108	9129499
WDH310	48 3/4	1611572	2712528	1141206	0312928	9069389	9077109	9129500
WDH42	52 3/4	1611573	2712532	1141208	0312932	9069390	9077110	9129501
WDH46	56 3/4	1611574	2712536	1141210	0312936	9069391	9077111	9129502
WDH410	60 3/4	1611516	9051561	9051562	9051563	9069392	9077112	9129503
WDH52	64 3/4	1611575	2712540	1141212	0312940	9069393	9077113	9129504
WDH56	68 3/4	1611576	2712544	1141214	0312944	9069394	9077114	9129505
WDH510	72 3/4	1611517	9051564	9051565	9051566	9069395	9077115	9129506
WDH62	76 3/4	1611577	2712548	1141216	0312948	9069396	9077116	9129507

Support Mullion Kit Components

Exterior Trim Strip - Support Mullion

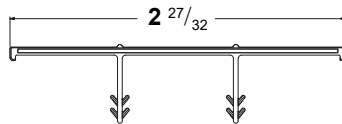

Unit No.	Length	White	Terratone	Sandtone	Forest Green	Canvas	Dark Bronze	Black
WDH144	144	1611579	1448620	0611034	0514106	By description	By description	By description

Filler - Support Mullion

Unit No.	Length	Order No.
WDH144	144	1611578

Joining Components

Reinforced Steel Mullion Illustration

Note:

See [Joining Guide 0005184](#).

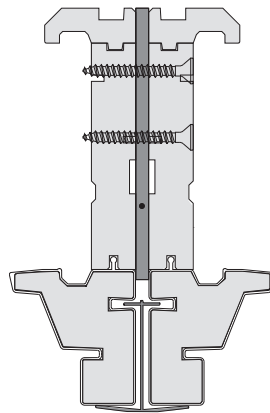

Steel Reinforced Narrow Mullion
for Double-Hung Windows

Reinforced Steel Mull Joining Components

Note:

See [Joining Guide 0005184](#).

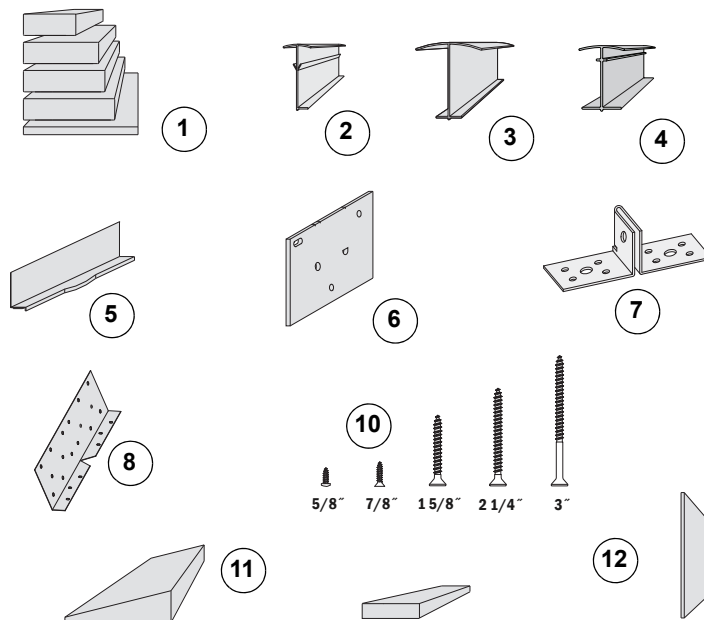

Reinforced Steel Mull Joining Components
for Double-Hung Windows

Joining Components

Inside Casing - Steel Reinforced Mullion Ref. No. 1 page 65					
Note: Inside wood casing must be modified. See installation instructions.					
		Length	2 3/8"	2 5/8"	2 15/16"
		96 in	2340602	2340606	2340614
		144 in	2340604	2340608	2340616

Exterior Trim Strip - Transom/ RIA/ Horizontal Ref. No. 2 page 65								
	Length	White	Terratone®	Sandtone	Forest Green	Canvas	Dark Bronze	Black
	150 in	2340520	2340522	2340524	2340526	9087235	9087272	9129277

Exterior Trim Strip - TW / Vertical Ref. No. 3 page 65								
	Length	White	Terratone®	Sandtone	Forest Green	Canvas	Dark Bronze	Black
	150 in	1632926	2741726	1142426	0331797	9053177	9073178	9129320

Exterior Trim Strip - Transom/TWT/ Horizontal Ref. No. 4 page 65								
	Length	White	Terratone®	Sandtone	Forest Green	Canvas	Dark Bronze	Black
	48 in	0102713	0102726	0102725	0102727	9076696	9076929	9133084
	84 in	0102728	0102730	0102729	0102731	9076697	9076930	9133085
	150 in	0102732	0102734	0102733	0102735	9076698	9076931	9130022

Exterior Narrow Mull Flashing Ref. No. 5 page 65								
	Length	White	Terra-tone®	Sandtone	Forest Green	Canvas	Dark Bronze	Black
	6 in		2742108		0331798	9053178	9073179	9127235

Joining Strip - Steel Reinforced Mullion Ref. No. 6 page 65			
		Unit Size	Order No.
		96 1/4 in	2340406
		114 in	2340408
		150 in	2340410

400 Series Woodwright® Double-Hung Windows (2002 to Present)

Standard Windows

Joining Components

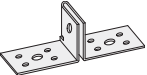
End Bracket - Steel Ref. No. 7 page 65		
		Order No.
		2340424

Gusset Plate Kit - Steel Reinforced / Narrow Mullion			
	Description	Finish	Order No.
Kit Includes: (2) Gusset plates (10) Reinforced mull spacers (10) Reinforced mull wedges (4) Jamb liner plugs, (2) Fasteners #10 x 2 1/2" PH FL HD SS with colored head 188 (18) Fasteners #10 x 3" typ17 PHSP FL STL with colored head (18) Fasteners #10 x 2 1/4" typ17 PH SPFL STL with colored heads (8) Fasteners #8 x 7/8" PH FL SS mull track (18) Fasteners #10 x 1 5/8" PH FL STL with colored heads (16) Fasteners #8 x 5/8" typ17 PH #6 SS (1) Instruction sheet #0005184		White	2340418
		Terratone®	2340420
		Sandtone	2340417
		Forest Green	2340419
		Canvas	9087234
		Dark Bronze	9087271
		Black	9128443

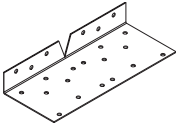
Gusset Plate - Reinforced Mullion Ref. No. 8 page 65		
		Order No.
		2340426

Joining Components

Universal Drip Cap - Continuous

Note:

Use on side-by-side or vertical joins mulled at the factory or distributor. Consists of 24 gauge aluminum material.

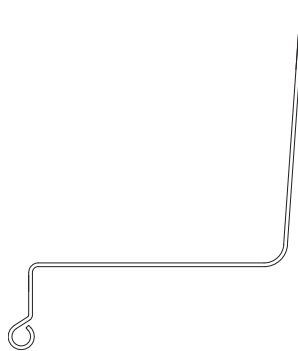

Drip Cap - Continuous - 72"

Qty in Package	White	Terratone	Sandtone	Forest Green	Canvas	Dark Bronze	Black
1	2222525	2222528	2222530	2222532	9003116	9020502	9003561
10	2222526	2222529	2222531	2222533	9003117	9020503	9003562
40	2222527	N/A	N/A	N/A	N/A	N/A	N/A

Drip Cap - Continuous - 120"

Qty in Package	White	Terratone	Sandtone	Forest Green	Canvas	Dark Bronze	Black
1	2222546	2222549	2222551	2222553	9003126	9020504	9003569
10	2222547	2222550	2222552	2222554	9003127	9020505	9003570
40	2222548	N/A	N/A	N/A	N/A	N/A	N/A

Drip Cap - Continuous - 151 1/2"

Qty in Package	White	Terratone	Sandtone	Forest Green	Canvas	Dark Bronze	Black
1	2222555	2222557	2222559	2222561	9003130	9020506	9003577
10	2222556	2222558	2222560	2222562	9003131	9020507	9003578

400 Series Woodwright® Double-Hung Windows (2002 to Present)

Angle Bay Windows

Unit Sizes

Note:

Angle Bay Windows are assembled with multiple Woodwright® Double-Hung and Picture Windows. Look in the standard window pages of this section for most replacement parts. Angle Bay units use specially designed mullion posts, side flanges, extension jambs, and head/seat boards. Replacements for these and other special Angle Bay parts can be found in the 400 Tilt-Wash Parts Catalog. Horizontal joining kits are unique to Woodwright® units and can be found on [page 62](#). Angle Bay units are available in pine, only. They are not available in oak, maple, or primed white. See [Architectural Detail](#) files.

Unit Sizes - Double-Hung Angle Bay					
Unit Sizes - Double-Hung Angle Bay 45° / 1-8 Flankers					
Projection*	17 15/16" (456)	17 15/16" (456)	17 15/16" (456)	17 15/16" (456)	17 15/16" (456)
Unit Dimension	6'-8 7/16" (2043)	7'-6 1/8" (2289)	8'-2 1/8" (2492)	8'-10 1/8" (2696)	9'-6 1/8" (2899)
Rough Opening	6'-7 1/8" (2010)	7'-4 7/8" (2257)	8'-0 3/4" (2445)	8'-8 3/4" (2661)	9'-4 3/4" (2864)
4'-2 1/4" (1276)					
	WDH45-34310-18	WDH45-20310-2-18	WDH45-24310-2-18	WDH45-28310-2-18	WDH45-30310-2-18
4'-6 1/4" (1378)					
	WDH45-3442-18	WDH45-2042-2-18	WDH45-2442-2-18	WDH45-2842-2-18	WDH45-3042-2-18
4'-10 1/4" (1480)					
	WDH45-3446-18	WDH45-2046-2-18	WDH45-2446-2-18	WDH45-2846-2-18	WDH45-3046-2-18
5'-6 1/4" (1683)					
	WDH45-3452-18	WDH45-2052-2-18	WDH45-2452-2-18	WDH45-2852-2-18	WDH45-3052-2-18
5'-10 1/4" (1784)					
	WDH45-3456-18	WDH45-2056-2-18	WDH45-2456-2-18	WDH45-2856-2-18	WDH45-3056-2-18
6'-6 1/4" (1988)					
	WDH45-3462-18	WDH45-2062-2-18	WDH45-2462-2-18	WDH45-2862-2-18	WDH45-3062-2-18
45° Woodwright® Double-Hung Angle Bay with 1-8 Flankers					

Unit Sizes

Unit Sizes - Double-Hung Angle Bay 45° / 2-0 Flankers

Projection*	20 3/4" (527)	20 3/4" (527)	20 3/4" (527)	20 3/4" (527)	20 3/4" (527)
Unit Dimension	7'-2 1/8" (2188)	7'-11 13/16" (2434)	8'-7 13/16" (2637)	9'-3 13/16" (2840)	9'-11 13/16" (3043)
Rough Opening	7'-0 3/4" (2153)	7'-10 1/2" (2400)	8'-6 1/2" (2604)	9'-2 1/2" (2807)	9'-10 1/2" (3010)
4'-2 1/4" (1276)					
	WDH45-34310-20	WDH45-20310-2-20	WDH45-24310-2-20	WDH45-28310-2-20	WDH45-30310-2-20
4'-6 1/4" (1378)					
	WDH45-3442-20	WDH45-2042-2-20	WDH45-2442-2-20	WDH45-2842-2-20	WDH45-3042-2-20
4'-10 1/4" (1480)					
	WDH45-3446-20	WDH45-2046-2-20	WDH45-2446-2-20	WDH45-2846-2-20	WDH45-3046-2-20
5'-6 1/4" (1683)					
	WDH45-3452-20	WDH45-2052-2-20	WDH45-2452-2-20	WDH45-2852-2-20	WDH45-3052-2-20
5'-10 1/4" (1784)					
	WDH45-3456-20	WDH45-2056-2-20	WDH45-2456-2-20	WDH45-2856-2-20	WDH45-3056-2-20
6'-6 3/4" (1988)					
	WDH45-3462-20	WDH45-2062-2-20	WDH45-2462-2-20	WDH45-2862-2-20	WDH45-3062-2-20

45° Woodwright® Double-Hung Angle Bay with 2-0 Flankers

400 Series Woodwright® Double-Hung Windows (2002 to Present)

Angle Bay Windows

Unit Sizes

Unit Sizes - Double-Hung Angle Bay 30° / 1-8 Flankers

Projection*	12 3/4" (324)	12 3/4" (324)	12 3/4" (324)	12 3/4" (324)	12 3/4" (324)
Unit Dimension	7'-0 15/16" (2142)	7'-10 5/8" (2403)	8'-6 5/8" (2599)	9'-2 5/8" (2810)	9'-10 5/8" (3013)
Rough Opening	7'-0 1/8" (2137)	7'-9 3/4" (2581)	8'-5 3/4" (2584)	9'-1 3/4" (2788)	9'-9 3/4" (2991)
4'-2 1/4" (1276) 4'-2 3/4" (1289)					
WDH30-34310-18	WDH30-20310-2-18	WDH30-24310-2-18	WDH30-28310-2-18	WDH30-30310-2-18	
4'-6 1/4" (1378) 4'-6 3/4" (1391)					
WDH30-3442-18	WDH30-2042-2-18	WDH30-2442-2-18	WDH30-2842-2-18	WDH30-3042-2-18	
4'-10 1/4" (1480) 4'-10 3/4" (1492)					
WDH30-3446-18	WDH30-2046-2-18	WDH30-2446-2-18	WDH30-2846-2-18	WDH30-3046-2-18	
5'-6 1/4" (1683) 5'-6 3/4" (1695)					
WDH30-3452-18	WDH30-2052-2-18	WDH30-2452-2-18	WDH30-2852-2-18	WDH30-3052-2-18	
5'-10 1/4" (1784) 5'-10 3/4" (1797)					
WDH30-3456-18	WDH30-2056-2-18	WDH30-2456-2-18	WDH30-2856-2-18	WDH30-3056-2-18	
6'-6 1/4" (1988) 6'-6 3/4" (2000)					
WDH30-3462-18	WDH30-2062-2-18	WDH30-2462-2-18	WDH30-2862-2-18	WDH30-3062-2-18	

30° Woodwright® Double-Hung Angle Bay with 1-8 Flankers

Unit Sizes

Unit Sizes - Double-Hung Angle Bay 30° / 2-0 Flankers

Projection*	14 3/4" (375)	14 3/4" (375)	14 3/4" (375)	14 3/4" (375)	14 3/4" (375)
Unit Dimension	7'-7 7/8" (2334)	8'-5 9/16" (2580)	9'-1 9/16" (2783)	9'-9 9/16" (2986)	10'-5 9/16" (3189)
Rough Opening	7'-7" (2311)	8'-4 3/4" (2559)	9'-0 3/4" (2762)	9'-8 3/4" (2965)	10'-4 3/4" (3169)
4'-2 1/4" (1276)					
	WDH30-34310-20	WDH30-20310-2-20	WDH30-24310-2-20	WDH30-28310-2-20	WDH30-30310-2-20
4'-6 1/4" (1378)					
	WDH30-3442-20	WDH30-2042-2-20	WDH30-2442-2-20	WDH30-2842-2-20	WDH30-3042-2-20
4'-10 1/4" (1480)					
	WDH30-3446-20	WDH30-2046-2-20	WDH30-2446-2-20	WDH30-2846-2-20	WDH30-3046-2-20
5'-6 1/4" (1683)					
	WDH30-3452-20	WDH30-2052-2-20	WDH30-2452-2-20	WDH30-2852-2-20	WDH30-3052-2-20
5'-10 1/4" (1784)					
	WDH30-3456-20	WDH30-2056-2-20	WDH30-2456-2-20	WDH30-2856-2-20	WDH30-3056-2-20
6'-6 1/4" (1988)					
	WDH30-3462-20	WDH30-2062-2-20	WDH30-2462-2-20	WDH30-2862-2-20	WDH30-3062-2-20

30° Woodwright® Double-Hung Angle Bay with 2-0 Flankers











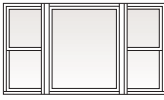





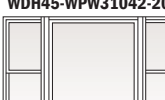
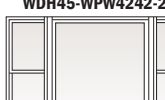

400 Series Woodwright® Double-Hung Windows (2002 to Present)

Angle Bay Windows

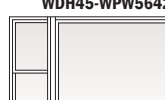
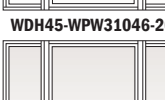
Unit Sizes

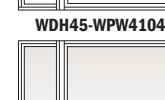
Unit Sizes - Double-Hung / Picture Windows Angle Bay

Unit Sizes - Double-Hung / Picture Windows Angle Bay 45° / 2-0 Flankers

Projection*	20 3/4" (527)	20 3/4" (527)	20 3/4" (527)	20 3/4" (527)	20 3/4" (527)	20 3/4" (527)
Unit Dimension	6'-10 1/8" (2086)	7'-2 1/8" (2188)	7'-7 13/16" (2332)	7'-11 13/16" (2434)	8'-7 13/16" (2637)	9'-3 13/16" (2840)
Rough Opening	6'-8 3/4" (2051)	7'-0 3/4" (2153)	7'-6 1/2" (2299)	7'-10 1/2" (2400)	8'-6 1/2" (2604)	9'-2 1/2" (2807)
4'-2 1/4" (1276)						
	WDH45-WPW30310-20		WDH45-WPW310310-20	WDH45-WPW42310-20	WDH45-WPW410310-20	
4'-6 3/4" (1378)						
	WDH45-WPW3042-20	WDH45-WPW3442-20	WDH45-WPW31042-20	WDH45-WPW4242-20	WDH45-WPW41042-20	WDH45-WPW5642-20
4'-10 1/4" (1480)						
	WDH45-WPW3046-20	WDH45-WPW3446-20	WDH45-WPW31046-20	WDH45-WPW4246-20	WDH45-WPW41046-20	WDH45-WPW5646-20
5'-6 3/4" (1683)						
	WDH45-WPW3052-20		WDH45-WPW31052-20	WDH45-WPW4252-20	WDH45-WPW41052-20	
5'-10 1/4" (1784)						
			WDH45-WPW31056-20	WDH45-WPW4256-20		
6'-6 1/4" (1988)						
			WDH45-WPW31062-20	WDH45-WPW4262-20		

45° Woodwright® Double-Hung/Picture Window Angle Bay with 2-0 Flankers

Unit Sizes

Unit Sizes - Double-Hung Window Angle Bay 30° / 2-0 Flankers						
Projection*	14 3/4" (375)	14 3/4" (375)	14 3/4" (375)	14 3/4" (375)	14 3/4" (375)	14 3/4" (375)
Unit Dimension	7'-3 7/8" (2232)	7'-7 7/8" (2334)	8'-1 9/16" (2478)	8'-5 9/16" (2580)	9'-1 9/16" (2783)	9'-9 9/16" (2986)
Rough Opening	7'-3" (2210)	7'-7" (2311)	8'-0 3/4" (2457)	8'-4 3/4" (2559)	9'-0 3/4" (2762)	9'-8 3/4" (2965)
4'-2 1/4" (1276) 4'-2 3/4" (1289)						
	WDH30-WPW30310-20		WDH30-WPW310310-20	WDH30-WPW42310-20	WDH30-WPW410310-20	
4'-6 1/4" (1378) 4'-6 3/4" (1391)						
	WDH30-WPW3042-20	WDH30-WPW3442-20	WDH30-WPW31042-20	WDH30-WPW4242-20	WDH30-WPW41042-20	WDH30-WPW5642-20
4'-10 1/4" (1480) 4'-10 3/4" (1492)						
	WDH30-WPW3046-20	WDH30-WPW3446-20	WDH30-WPW31046-20	WDH30-WPW4246-20	WDH30-WPW41046-20	WDH30-WPW5646-20
5'-6 1/4" (1683) 5'-6 3/4" (1695)						
	WDH30-WPW3052-20		WDH30-WPW31052-20	WDH30-WPW4252-20	WDH30-WPW41052-20	
5'-10 1/4" (1784) 5'-10 3/4" (1797)						
			WDH30-WPW31056-20	WDH30-WPW4256-20		
6'-6 1/4" (1988) 6'-6 3/4" (2000)						
			WDH30-WPW31062-20	WDH30-WPW4262-20		

30° Woodwright® Double-Hung Window Angle Bay with 2-0 Flankers

400 Series Woodwright® Double-Hung Windows (2002 to Present)

Service Replacement

Service Replacement Only

Service Replacement Only Parts

Note:

This section is specifically designed for parts that should only be ordered if a Territory Service Manager/Service Provider Company has requested them to be ordered or if the customer agrees to also pay for a non-warranty repair/replace service job (subject to availability) for these parts to be installed. We do not recommend anyone other than a trained AW employee or Service Provider install these parts due to the complexity of installation, modifications required for installation and/or requirement of special tools.

Weatherstrip

Weatherstrip - Upper Interlock

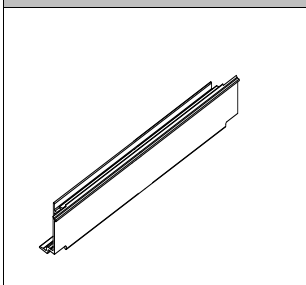

Note:

Upper interlock weatherstrip for standard and custom size windows is made to order.

To order, state:

1. Description of Part (upper sash interlock)
2. Quantity
3. Product ID (from product label, see [Service Guide 9051877](#))

Weatherstrip - Lower Interlock / Lineal (December 2007 to February 21, 2018)

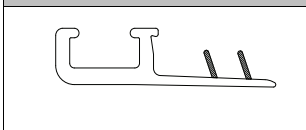

Note:

Cut to length if necessary. Also order [felt spacer](#) and screws.

Length

52 ⁷/₁₆

Order No.

0102016

Screw - Lower Interlock



Description

PH pan 8 - 15 x 3/8 #5 302 SS

Order No.

0102714

Weatherstrip - Interlock Clash



Note:

To be used on units with old style interlock used prior to December of 2007.

Color

White

Gray

Order No.

2855171

2855137

Service Replacement Only

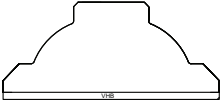
Exterior Grilles - HDN									
Exterior Grille - HDN / Lineal / PVC									
									
Length	White			Terratone			Sandtone		
	3/4"	7/8"	1 1/8"	3/4"	7/8"	1 1/8"	3/4"	7/8"	1 1/8"
60 in	2322030	2322034	2322038	N/A	N/A	N/A	N/A	N/A	N/A
84 in	2322031	2322035	2322039	N/A	N/A	N/A	N/A	N/A	N/A

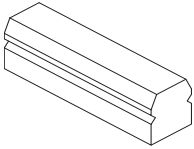
Service Materials		
Sash Spacer - Felt / Lower Sash Check Rail		
		Order No.
		0102780
VHB Tape		
	Description	Order No.
	1/4" x 10 ft.	0102627

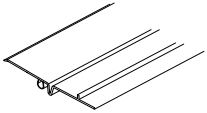
Jamb Liners				
Jamb Liner - Head				
	Note: Cut to size for specific application.	Length	Order No.	
		53 inch	White/White	0102007
			Gray/Pine	0102010
			Gray/Maple	0101999
			Gray/Oak	0101998

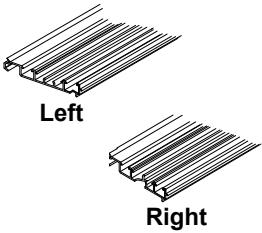
Jamb Liner Kit - Side	
 <p style="text-align: center;">Left</p> <p style="text-align: center;">Right</p>	Note: Side jamb liners for standard and custom size windows are made to order.
	Kit Includes: Left and right hand liners and components.
	<i>To order, state:</i>
	<ol style="list-style-type: none"> Description of Part (Side Jamb Liner) Quantity Product ID (from product label, see Service Guide 9051877)

400 Series Woodwright® Double-Hung Windows (2002 to Present)

Service Replacement

Service Replacement Only

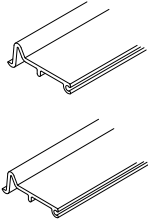
Weatherstrip - Upper Side Jamb				
	Note: Cut to length. Order weatherstrip with maple or oak finish using Product ID (from product label, see Service Guide 9051877)	Length	Finish	Order No.
		4 ft.	White/Pine	0102721

Service Replacement Only
