

What's in This Section

DP Upgrade Windows	Page 3
Parts Illustration	3
Parts Illustration - Interior View	3
Parts Illustration - Exterior View	4
Unit Sizes	5
Unit Size Chart / Even	5
Unit Size Chart / Cottage	6
Product History	7
Product History	7
Sash	8
Sash Size Table	8
Sash Graphic - Upper	13
Sash Options - Upper	14
Sash Graphic - Lower	15
Sash Options - Lower	16
Weatherstrip	17
Glazing Beads - High Performance / 5/8"	19
Glazing Beads - HDN	21
Sash Hardware	23
Sash Hardware / Opening Control Device Kit	24
Sash Components / Miscellaneous	25
Sash Balancers	26
Balancers - Tab and Shoe Illustration	26
Balancer Usage Chart	27
Balancers - Block and Tackle with Shoe	38
Balancers - Block and Tackle with Tab	39
Balancer Parts	39
Insect Screens	40
Insect Screens - Full / Even / TruScene®	40
Insect Screens - Full / Cottage / TruScene®	45
Insect Screens - Full / Even / Standard Mesh	48
Insect Screens - Full / Cottage / Standard Mesh	53
Insect Screens - Half / Even & Cottage / TruScene® (4/2007 - Present)	56
Insect Screens - Half / Even & Cottage / Standard Mesh (4/2007 - Present)	66
Insect Screen Bug Seal - Half	76
Insect Screen Hardware	77
Frames	78

Frame Assembly Graphic 79

Frames 80

Stops - Head/Sill (2004 - Present) 81

Stops - Sill (DP Upgrade and Impact Resistant) (4/2007 - Present) 81

Stops - Side 82

Vintage Stops - Side 83

Extension Jamb / Wood / Lineal 84

Extension Jamb / Painted / Lineal 85

Jamb Liners 86

Balancer Cover Table (6/2017 - Present) 88

Vintage Balancer Cover Table (1992 - 8/2017) 89

Flange 90

Frame Hardware 91

Parts Illustration - Interior View

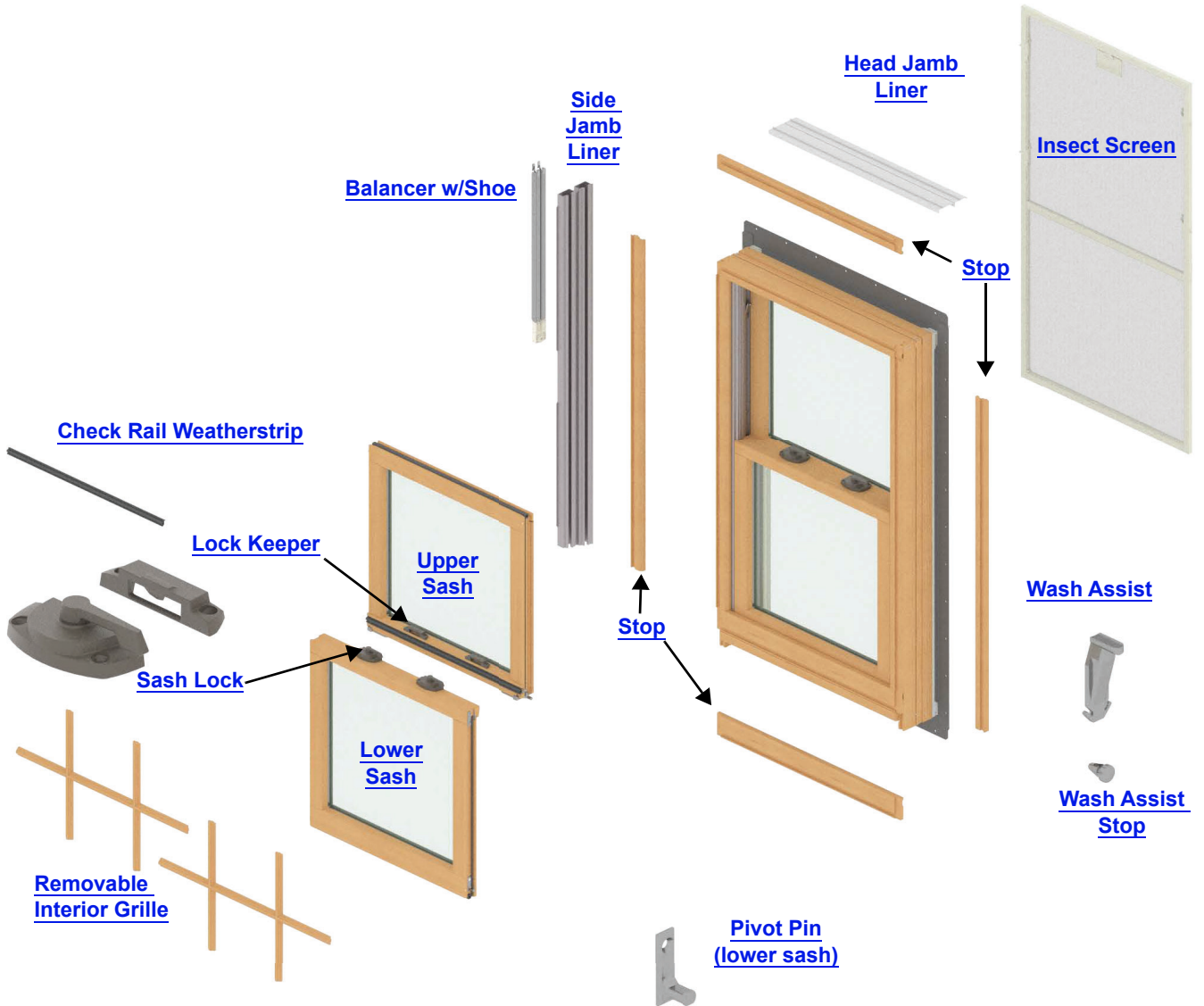

Tilt-Wash DP Upgrade Window Unit Parts

Parts Illustration

Parts Illustration - Exterior View

Note:

Standard even window shown. Graphic shows wood finish on exterior of sash. Can we show painted surface in graphic?

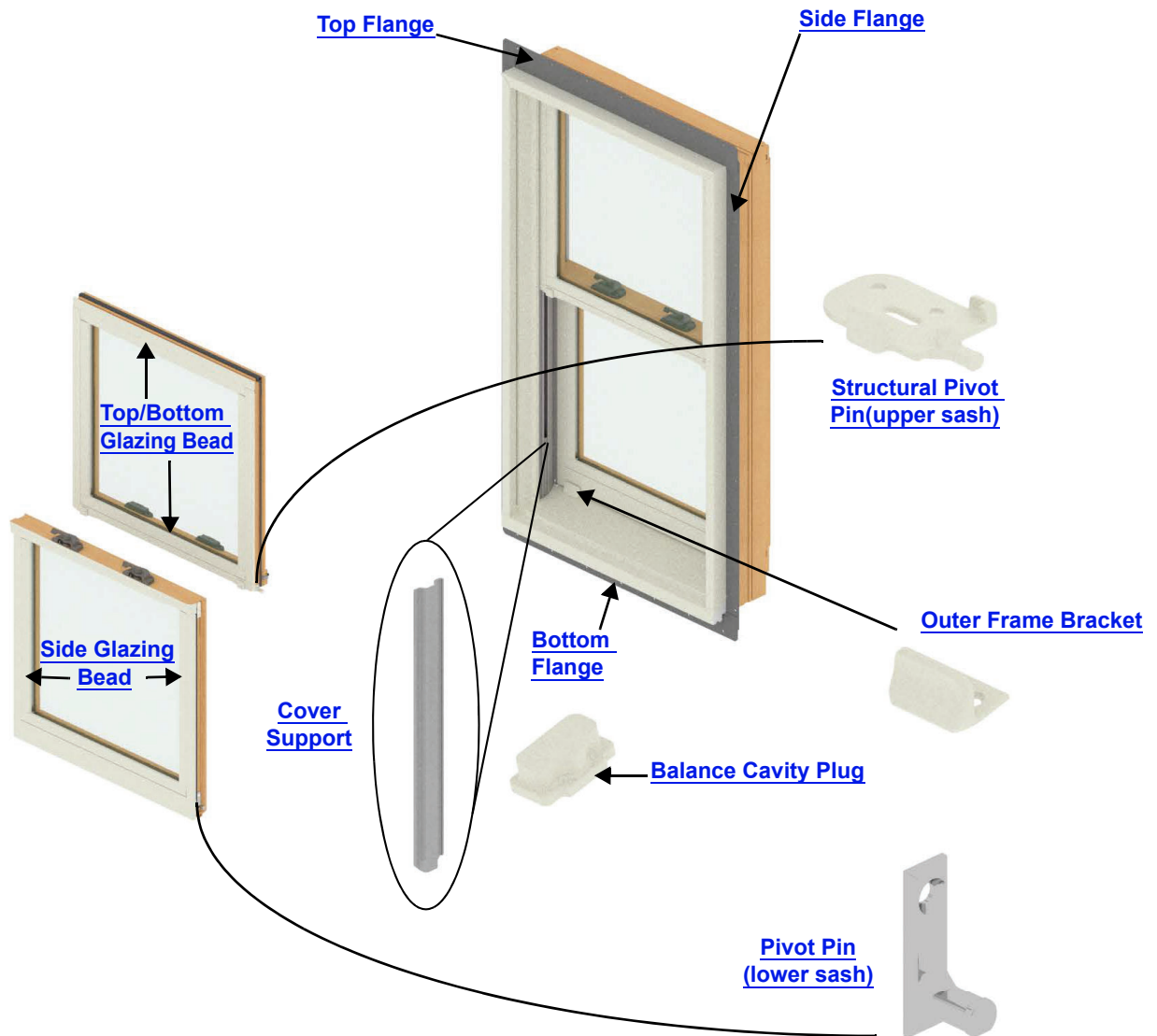

Tilt-Wash DP Upgrade Window Unit Parts

400 Series Tilt-Wash PG Upgrade Windows (2003 to Present)

DP Upgrade Windows

Unit Sizes

Unit Size Chart / Even

Note:

See [Measuring Visible Glass Video](#).

- 46 Height unobstructed glass dimension changed on March 28, 2017. See [Size Chart](#).
- 310 Height unobstructed glass dimension changed on August 22, 2017. See [Size Chart](#).

Unit Dimension	1'-9 5/8" (549)	2'-1 5/8" (651)	2'-5 5/8" (752)	2'-7 5/8" (803)	2'-9 5/8" (854)	2'-11 5/8" (905)	3'-1 5/8" (956)	3'-5 5/8" (1057)	3'-9 5/8" (1159)
Minimum Rough Opening	1'-10 1/8" (562)	2'-2 1/8" (664)	2'-6 1/8" (765)	2'-8 1/8" (816)	2'-10 1/8" (867)	3'-0 1/8" (917)	3'-2 1/8" (968)	3'-6 1/8" (1070)	3'-10 1/8" (1172)
Unobstructed Glass	15" (381)	19" (483)	23" (584)	25" (635)	27" (686)	29" (737)	31" (787)	35" (889)	39" (991)
3'-0 7/8" (937)	TW18210	TW20210	TW24210	TW26210	TW28210	TW210210	TW30210	TW34210	TW38210
3'-0 7/8" (937)									
3'-0 7/8" (937)									
3'-4 7/8" (1038)	TW1832	TW2032	TW2432	TW2632	TW2832	TW21032	TW3032	TW3432	TW3832
3'-4 7/8" (1038)									
3'-4 7/8" (1038)									
3'-8 7/8" (1140)	TW1836	TW2036	TW2436	TW2636	TW2836	TW21036	TW3036	TW3436	TW3836
3'-8 7/8" (1140)									
3'-8 7/8" (1140)									
4'-0 7/8" (1241)	TW18310	TW20310	TW24310	TW26310	TW28310	TW210310	TW30310	TW34310	TW38310
4'-0 7/8" (1241)									
4'-0 7/8" (1241)									
4'-4 7/8" (1343)	TW1842	TW2042	TW2442	TW2642	TW2842	TW21042	TW3042	TW3442	TW3842
4'-4 7/8" (1343)									
4'-4 7/8" (1343)									
4'-8 7/8" (1445)	TW1846	TW2046	TW2446	TW2646	TW2846	TW21046	TW3046*	TW3446*	TW3846*
4'-8 7/8" (1445)									
4'-8 7/8" (1445)									
5'-0 7/8" (1546)	TW18410	TW20410	TW24410	TW26410	TW28410	TW210410*	TW30410*	TW34410*	TW38410*
5'-0 7/8" (1546)									
5'-0 7/8" (1546)									
5'-4 7/8" (1648)	TW1852	TW2052	TW2452	TW2652	TW2852*	TW21052*	TW3052*	TW3452*	TW3852*
5'-4 7/8" (1648)									
5'-4 7/8" (1648)									
5'-8 7/8" (1749)	TW1856	TW2056	TW2456	TW2656	TW2856	TW21056	TW3056*	TW3456*	TW3856*
5'-8 7/8" (1749)									
5'-8 7/8" (1749)									
6'-0 7/8" (1851)	TW18510	TW20510	TW24510*	TW26510*	TW28510*	TW210510*	TW30510*	TW34510*	TW38510*
6'-0 7/8" (1851)									
6'-0 7/8" (1851)									
6'-4 7/8" (1953)	TW1862	TW2062	TW2462*	TW2662*	TW2862*	TW21062*	TW3062*	TW3462*	TW3862*
6'-4 7/8" (1953)									
6'-4 7/8" (1953)									

SEE NEW UNOBSTRUCTED GLASS SIZES

(1992 - August 2017)

SEE NEW UNOBSTRUCTED GLASS SIZES

(1992 - March 2017)

These 5'-9" height units are "cottage style" units, and have unequal sash. The top sash is shorter than the bottom sash.



Units with equal sash heights are ordered by description. Contact dealer for lead times.

* "Window Dimension" always refers to outside frame to frame dimension.
 • Dimensions in parentheses are in millimeters.
 • Meet or exceed clear opening area of 5.7 sq.ft. or 0.53 m², clear opening width of 20" (508) and clear opening height of 24" (610).

Tilt-Wash DP Upgrade Standard Sizes

Unit Sizes

Unit Size Chart / Cottage

Note:

See [Measuring Visible Glass Video](#).

• 56 Height unobstructed glass dimension changed on March 28, 2017. See [Size Chart](#).

Window Dimension	1'-9 5/8" (549)	2'-1 5/8" (651)	2'-5 5/8" (752)	2'-7 5/8" (803)	2'-9 5/8" (854)	2'-11 5/8" (905)	3'-1 5/8" (956)	3'-5 5/8" (1057)	3'-9 5/8" (1159)
Minimum Rough Opening	1'-10 1/8" (562)	2'-2 1/8" (664)	2'-6 1/8" (765)	2'-8 1/8" (816)	2'-10 1/8" (867)	3'-0 1/8" (917)	3'-2 1/8" (968)	3'-6 1/8" (1070)	3'-10 1/8" (1172)
Unobstructed Glass	15" (381)	19" (483)	23" (584)	25" (635)	27" (686)	29" (737)	31" (787)	35" (889)	39" (991)

Window Dimension	CUSTOM WIDTHS — 21 5/8" to 45 5/8"								
	21 5/8" (549)	24 1/8" (613)	26 5/8" (681)	29 1/8" (745)	31 5/8" (809)	34 1/8" (873)	36 5/8" (937)	39 1/8" (1001)	41 5/8" (1065)
4'-0 7/8" (1241)	TW18310	TW20310	TW24310	TW26310	TW28310	TW210310	TW30310	TW34310	TW38310
4'-4 7/8" (1343)	TW1842	TW2042	TW2442	TW2642	TW2842	TW21042	TW3042	TW3442	TW3842
4'-8 7/8" (1445)	TW1846	TW2046	TW2446	TW2646	TW2846	TW21046	TW3046	TW3446	TW3846
5'-0 7/8" (1546)	TW18410	TW20410	TW24410	TW26410	TW28410	TW210410	TW30410	TW34410	TW38410
5'-4 7/8" (1648)	TW1852	TW2052	TW2452	TW2652	TW2852	TW21052	TW3052	TW3452	TW3852
5'-8 7/8" (1749)	TW1856	TW2056	TW2456	TW2656	TW2856	TW21056	TW3056*	TW3456*	TW3856*
6'-0 7/8" (1851)	TW18510	TW20510	TW24510	TW26510	TW28510	TW210510	TW30510*	TW34510*	TW38510*
6'-4 7/8" (1953)	TW1862	TW2062	TW2462	TW2662	TW2862	TW21062*	TW3062*	TW3462*	TW3862*

• "Window Dimension" always refers to outside frame to frame dimension.
 • Dimensions in parentheses are in millimeters.
 • Meet or exceed clear opening area of 5.7 sq.ft. or 0.53 m², clear opening width of 20" (508) and clear opening height of 24" (610).



Custom-size windows are available in 1/8" (3) increments.

Windows 6' 0 7/8" (1851) and 6' 4 7/8" (1953) high have interior and exterior brackets. Interior brackets, located on both sides of the check rail, must be flipped up for proper product performance.

(1992 - March 2017)

Tilt-Wash DP Upgrade Standard Cottage Sizes

400 Series Tilt-Wash PG Upgrade Windows (2003 to Present)

DP Upgrade Windows

Product History

Product History

- 2008** SmartSun™ glass introduced.
- 2007** Monolithic Impact Resistant glass introduced and marketed as Stormwatch because of DP/PG ratings achieved. See DH-207 for more detail.
- 2006** Brackets used on interior changed to “flip-up” design. See DH-206 for more detail.
- 2003** Factory applied DP Upgrade introduced.

Sash

Sash Size Table

Note:

- Upper and Lower Sash is measured outside edge to outside edge of sash frame.
- Unobstructed Glass is measured from outside edge to outside edge of visible glass only. See [Measuring Visible Glass Video](#).
- Sash with HDN (High Definition) grilles use unique glazing bead listed in sash section.
- 46 Even (upper and lower) and 56 Cottage (upper and lower) height changed in April 2017.
- 310 Even (upper and lower) height changed in September 2017.
- When using/ordering for Conversion Kits the 310 and 46 sizes are **not** impacted by design changes made in 2017.

Unit Size		Upper Sash			Lower Sash		
Unit No.	Overall Sash (w x h)	Unobstructed Glass (w x h)	Actual Glass (w x h)	Overall Sash (w x h)	Unobstructed Glass (w x h)	Actual Glass (w x h)	
18	TW18210	18 11/32 x 17	15 x 13 15/16	16 x 14 31/32	18 11/32 x 17 13/16	15 x 13 15/16	16 x 14 31/32
	TW1832	18 11/32 x 19	15 x 15 15/16	16 x 16 31/32	18 11/32 x 19 13/16	15 x 15 15/16	16 x 16 31/32
	TW1836	18 11/32 x 21	15 x 17 15/16	16 x 18 31/32	18 11/32 x 21 13/16	15 x 17 15/16	16 x 18 31/32
	TW18310 (1992 - 8/2017)	18 11/32 x 23	15 x 19 15/16	16 x 20 31/32	18 11/32 x 23 13/16	15 x 19 15/16	16 x 20 31/32
	TW18310 (9/2017 - Present)	18 11/32 x 23 1/2	15 x 20 7/16	16 x 21 15/32	18 11/32 x 23 5/16	15 x 19 7/16	16 x 20 15/32
	TW1842	18 11/32 x 25	15 x 21 15/16	16 x 22 31/32	18 11/32 x 25 13/16	15 x 21 15/16	16 x 22 31/32
	TW1846 (1992 - 3/2017)	18 11/32 x 27	15 x 23 15/16	16 x 24 31/32	18 11/32 x 27 13/16	15 x 23 15/16	16 x 24 31/32
	TW1846 (4/2017 - Present)	18 11/32 x 27 1/2	15 x 24 7/16	16 x 25 15/32	18 11/32 x 27 5/16	15 x 23 7/16	16 x 24 15/32
	TW18410	18 11/32 x 29	15 x 25 15/16	16 x 26 31/32	18 11/32 x 29 13/16	15 x 25 15/16	16 x 26 31/32
	TW1852	18 11/32 x 31	15 x 27 15/16	16 x 28 31/32	18 11/32 x 31 13/16	15 x 27 15/16	16 x 28 31/32
	TW1856E	18 11/32 x 33	15 x 29 15/16	16 x 30 31/32	18 11/32 x 32 13/16	15 x 29 15/16	16 x 30 31/32
	TW1856C (1992 - 3/2017)	18 11/32 x 27	15 x 23 15/16	16 x 24 31/32	18 11/32 x 39 13/16	15 x 35 15/16	16 x 36 31/32
	TW1856C (4/2017 - Present)	18 11/32 x 27 1/2	15 x 24 7/16	16 x 25 15/32	18 11/32 x 39 5/16	15 x 35 7/16	16 x 36 15/32
	TW18510	18 11/32 x 35	15 x 31 15/16	16 x 32 31/32	18 11/32 x 35 13/16	15 x 31 15/16	16 x 32 31/32
TW1862	18 11/32 x 37	15 x 33 15/16	16 x 34 31/32	18 11/32 x 37 13/16	15 x 33 15/16	16 x 34 31/32	
20	TW20210	22 11/32 x 17	19 x 13 15/16	20 x 14 31/32	22 11/32 x 17 13/16	19 x 13 15/16	20 x 14 31/32
	TW2032	22 11/32 x 19	19 x 15 15/16	20 x 16 31/32	22 11/32 x 19 13/16	19 x 15 15/16	20 x 16 31/32
	TW2036	22 11/32 x 21	19 x 17 15/16	20 x 18 31/32	22 11/32 x 21 13/16	19 x 17 15/16	20 x 18 31/32
	TW20310 (1992 - 8/2017)	22 11/32 x 23	19 x 19 15/16	20 x 20 31/32	22 11/32 x 23 13/16	19 x 19 15/16	20 x 20 31/32
	TW20310 (9/2017 - Present)	22 11/32 x 23 1/2	19 x 20 7/16	20 x 21 15/32	22 11/32 x 23 5/16	19 x 19 7/16	20 x 20 15/32
	TW2042	22 11/32 x 25	19 x 21 15/16	20 x 22 31/32	22 11/32 x 25 13/16	19 x 21 15/16	20 x 22 31/32
	TW2046 (1992 - 3/2017)	22 11/32 x 27	19 x 23 15/16	20 x 24 31/32	22 11/32 x 27 13/16	19 x 23 15/16	20 x 24 31/32
	TW2046 (4/2017 - Present)	22 11/32 x 27 1/2	19 x 24 7/16	20 x 25 15/32	22 11/32 x 27 5/16	19 x 23 7/16	20 x 24 15/32
	TW20410	22 11/32 x 29	19 x 25 15/16	20 x 26 31/32	22 11/32 x 29 13/16	19 x 25 15/16	20 x 26 31/32
	TW2052	22 11/32 x 31	19 x 27 15/16	20 x 28 31/32	22 11/32 x 31 13/16	19 x 27 15/16	20 x 28 31/32
	TW2056E	22 11/32 x 33	19 x 29 15/16	20 x 30 31/32	22 11/32 x 32 13/16	19 x 29 15/16	20 x 30 31/32
	TW2056C (1992 - 3/2017)	22 11/32 x 27	19 x 23 15/16	20 x 24 31/32	22 11/32 x 39 13/16	19 x 35 15/16	20 x 36 31/32
	TW2056C (4/2017 - Present)	22 11/32 x 27 1/2	19 x 24 7/16	20 x 25 15/32	22 11/32 x 39 5/16	19 x 35 7/16	20 x 36 15/32
	TW20510	22 11/32 x 35	19 x 31 15/16	20 x 32 31/32	22 11/32 x 35 13/16	19 x 31 15/16	20 x 32 31/32
TW2062	22 11/32 x 37	19 x 33 15/16	20 x 34 31/32	22 11/32 x 37 13/16	19 x 33 15/16	20 x 34 31/32	

400 Series Tilt-Wash PG Upgrade Windows (2003 to Present)

DP Upgrade Windows

Sash

Unit Size	Upper Sash			Lower Sash			
Unit No.	Overall Sash (w x h)	Unobstructed Glass (w x h)	Actual Glass (w x h)	Overall Sash (w x h)	Unobstructed Glass (w x h)	Actual Glass (w x h)	
24	TW24210	26 ¹¹ / ₃₂ × 17	23 × 13 ¹⁵ / ₁₆	24 × 14 ³¹ / ₃₂	26 ¹¹ / ₃₂ × 17 ¹³ / ₁₆	23 × 13 ¹⁵ / ₁₆	24 × 14 ³¹ / ₃₂
	TW2432	26 ¹¹ / ₃₂ × 19	23 × 15 ¹⁵ / ₁₆	24 × 16 ³¹ / ₃₂	26 ¹¹ / ₃₂ × 19 ¹³ / ₁₆	23 × 15 ¹⁵ / ₁₆	24 × 16 ³¹ / ₃₂
	TW2436	26 ¹¹ / ₃₂ × 21	23 × 17 ¹⁵ / ₁₆	24 × 18 ³¹ / ₃₂	26 ¹¹ / ₃₂ × 21 ¹³ / ₁₆	23 × 17 ¹⁵ / ₁₆	24 × 18 ³¹ / ₃₂
	TW24310 (1992 - 8/2017)	26 ¹¹ / ₃₂ × 23	23 × 19 ¹⁵ / ₁₆	24 × 20 ³¹ / ₃₂	26 ¹¹ / ₃₂ × 23 ¹³ / ₁₆	23 × 19 ¹⁵ / ₁₆	24 × 20 ³¹ / ₃₂
	TW24310 (9/2017 - Present)	26 ¹¹ / ₃₂ × 23 ¹ / ₂	23 × 20 ⁷ / ₁₆	24 × 21 ¹⁵ / ₃₂	26 ¹¹ / ₃₂ × 23 ⁵ / ₁₆	23 × 19 ⁷ / ₁₆	24 × 20 ¹⁵ / ₃₂
	TW2442	26 ¹¹ / ₃₂ × 25	23 × 21 ¹⁵ / ₁₆	24 × 22 ³¹ / ₃₂	26 ¹¹ / ₃₂ × 25 ¹³ / ₁₆	23 × 21 ¹⁵ / ₁₆	24 × 22 ³¹ / ₃₂
	TW2446 (1992 - 3/2017)	26 ¹¹ / ₃₂ × 27	23 × 23 ¹⁵ / ₁₆	24 × 24 ³¹ / ₃₂	26 ¹¹ / ₃₂ × 27 ¹³ / ₁₆	23 × 23 ¹⁵ / ₁₆	24 × 24 ³¹ / ₃₂
	TW2446 (4/2017 - Present)	26 ¹¹ / ₃₂ × 27 ¹ / ₂	23 × 24 ⁷ / ₁₆	24 × 25 ¹⁵ / ₃₂	26 ¹¹ / ₃₂ × 27 ⁵ / ₁₆	23 × 23 ⁷ / ₁₆	24 × 24 ¹⁵ / ₃₂
	TW24410	26 ¹¹ / ₃₂ × 29	23 × 25 ¹⁵ / ₁₆	24 × 26 ³¹ / ₃₂	26 ¹¹ / ₃₂ × 29 ¹³ / ₁₆	23 × 25 ¹⁵ / ₁₆	24 × 26 ³¹ / ₃₂
	TW2452	26 ¹¹ / ₃₂ × 31	23 × 27 ¹⁵ / ₁₆	24 × 28 ³¹ / ₃₂	26 ¹¹ / ₃₂ × 31 ¹³ / ₁₆	23 × 27 ¹⁵ / ₁₆	24 × 28 ³¹ / ₃₂
	TW2456E	26 ¹¹ / ₃₂ × 33	23 × 29 ¹⁵ / ₁₆	24 × 30 ³¹ / ₃₂	26 ¹¹ / ₃₂ × 32 ³¹ / ₃₂	23 × 29 ¹⁵ / ₁₆	24 × 30 ³¹ / ₃₂
	TW2456C (1992 - 3/2017)	26 ¹¹ / ₃₂ × 27	23 × 23 ¹⁵ / ₁₆	24 × 24 ³¹ / ₃₂	26 ¹¹ / ₃₂ × 39 ¹³ / ₁₆	23 × 35 ¹⁵ / ₁₆	24 × 36 ³¹ / ₃₂
	TW2456C (4/2017 - Present)	26 ¹¹ / ₃₂ × 27 ¹ / ₂	23 × 24 ⁷ / ₁₆	24 × 25 ¹⁵ / ₃₂	26 ¹¹ / ₃₂ × 39 ⁵ / ₁₆	23 × 35 ⁷ / ₁₆	24 × 36 ¹⁵ / ₃₂
	TW24510	26 ¹¹ / ₃₂ × 35	23 × 31 ¹⁵ / ₁₆	24 × 32 ³¹ / ₃₂	26 ¹¹ / ₃₂ × 35 ¹³ / ₁₆	23 × 31 ¹⁵ / ₁₆	24 × 32 ³¹ / ₃₂
TW2462	26 ¹¹ / ₃₂ × 37	23 × 33 ¹⁵ / ₁₆	24 × 34 ³¹ / ₃₂	26 ¹¹ / ₃₂ × 37 ¹³ / ₁₆	23 × 33 ¹⁵ / ₁₆	24 × 34 ³¹ / ₃₂	
26	TW26210	28 ¹¹ / ₃₂ × 17	25 × 13 ¹⁵ / ₁₆	26 × 14 ³¹ / ₃₂	28 ¹¹ / ₃₂ × 17 ¹³ / ₁₆	25 × 13 ¹⁵ / ₁₆	26 × 14 ³¹ / ₃₂
	TW2632	28 ¹¹ / ₃₂ × 19	25 × 15 ¹⁵ / ₁₆	26 × 16 ³¹ / ₃₂	28 ¹¹ / ₃₂ × 19 ¹³ / ₁₆	25 × 15 ¹⁵ / ₁₆	26 × 16 ³¹ / ₃₂
	TW2636	28 ¹¹ / ₃₂ × 21	25 × 17 ¹⁵ / ₁₆	26 × 18 ³¹ / ₃₂	28 ¹¹ / ₃₂ × 21 ¹³ / ₁₆	25 × 17 ¹⁵ / ₁₆	26 × 18 ³¹ / ₃₂
	TW26310 (1992 - 8/2017)	28 ¹¹ / ₃₂ × 23	25 × 19 ¹⁵ / ₁₆	26 × 20 ³¹ / ₃₂	28 ¹¹ / ₃₂ × 23 ¹³ / ₁₆	25 × 19 ¹⁵ / ₁₆	26 × 20 ³¹ / ₃₂
	TW26310 (9/2017 - Present)	28 ¹¹ / ₃₂ × 23 ¹ / ₂	25 × 20 ⁷ / ₁₆	26 × 21 ¹⁵ / ₃₂	28 ¹¹ / ₃₂ × 23 ⁵ / ₁₆	25 × 19 ⁷ / ₁₆	26 × 20 ¹⁵ / ₃₂
	TW2642	28 ¹¹ / ₃₂ × 25	25 × 21 ¹⁵ / ₁₆	26 × 22 ³¹ / ₃₂	28 ¹¹ / ₃₂ × 25 ¹³ / ₁₆	25 × 21 ¹⁵ / ₁₆	26 × 22 ³¹ / ₃₂
	TW2646 (1992 - 3/2017)	28 ¹¹ / ₃₂ × 27	25 × 23 ¹⁵ / ₁₆	26 × 24 ³¹ / ₃₂	28 ¹¹ / ₃₂ × 27 ¹³ / ₁₆	25 × 23 ¹⁵ / ₁₆	26 × 24 ³¹ / ₃₂
	TW2646 (4/2017 - Present)	28 ¹¹ / ₃₂ × 27 ¹ / ₂	25 × 24 ⁷ / ₁₆	26 × 25 ¹⁵ / ₃₂	28 ¹¹ / ₃₂ × 27 ⁵ / ₁₆	25 × 23 ⁷ / ₁₆	26 × 24 ¹⁵ / ₃₂
	TW26410	28 ¹¹ / ₃₂ × 29	25 × 25 ¹⁵ / ₁₆	26 × 26 ³¹ / ₃₂	28 ¹¹ / ₃₂ × 29 ¹³ / ₁₆	25 × 25 ¹⁵ / ₁₆	26 × 26 ³¹ / ₃₂
	TW2652	28 ¹¹ / ₃₂ × 31	25 × 27 ¹⁵ / ₁₆	26 × 28 ³¹ / ₃₂	28 ¹¹ / ₃₂ × 31 ¹³ / ₁₆	25 × 27 ¹⁵ / ₁₆	26 × 28 ³¹ / ₃₂
	TW2656E	28 ¹¹ / ₃₂ × 33	25 × 29 ¹⁵ / ₁₆	26 × 30 ³¹ / ₃₂	28 ¹¹ / ₃₂ × 32 ³¹ / ₃₂	25 × 29 ¹⁵ / ₁₆	26 × 30 ³¹ / ₃₂
	TW2656C (1992 - 3/2017)	28 ¹¹ / ₃₂ × 27	25 × 23 ¹⁵ / ₁₆	26 × 24 ³¹ / ₃₂	28 ¹¹ / ₃₂ × 39 ¹³ / ₁₆	25 × 35 ¹⁵ / ₁₆	26 × 36 ³¹ / ₃₂
	TW2656C (4/2017 - Present)	28 ¹¹ / ₃₂ × 27 ¹ / ₂	25 × 24 ⁷ / ₁₆	26 × 25 ¹⁵ / ₃₂	28 ¹¹ / ₃₂ × 39 ⁵ / ₁₆	25 × 35 ⁷ / ₁₆	26 × 36 ¹⁵ / ₃₂
	TW26510	28 ¹¹ / ₃₂ × 35	25 × 31 ¹⁵ / ₁₆	26 × 32 ³¹ / ₃₂	28 ¹¹ / ₃₂ × 35 ¹³ / ₁₆	25 × 31 ¹⁵ / ₁₆	26 × 32 ³¹ / ₃₂
TW2662	28 ¹¹ / ₃₂ × 37	25 × 33 ¹⁵ / ₁₆	26 × 34 ³¹ / ₃₂	28 ¹¹ / ₃₂ × 37 ¹³ / ₁₆	25 × 33 ¹⁵ / ₁₆	26 × 34 ³¹ / ₃₂	

Sash

Unit Size		Upper Sash			Lower Sash		
Unit No.	Overall Sash (w x h)	Unobstructed Glass (w x h)	Actual Glass (w x h)	Overall Sash (w x h)	Unobstructed Glass (w x h)	Actual Glass (w x h)	
28	TW28210	30 11/32 x 17	27 x 13 15/16	28 x 14 31/32	30 11/32 x 17 13/16	27 x 13 15/16	28 x 14 31/32
	TW2832	30 11/32 x 19	27 x 15 15/16	28 x 16 31/32	30 11/32 x 19 13/16	27 x 15 15/16	28 x 16 31/32
	TW2836	30 11/32 x 21	27 x 17 15/16	28 x 18 31/32	30 11/32 x 21 13/16	27 x 17 15/16	28 x 18 31/32
	TW28310 (1992 - 8/2017)	30 11/32 x 23	27 x 19 15/16	28 x 20 31/32	30 11/32 x 23 13/16	27 x 19 15/16	28 x 20 31/32
	TW28310 (9/2017 - Present)	30 11/32 x 23 1/2	27 x 20 7/16	28 x 21 15/32	30 11/32 x 23 5/16	27 x 19 7/16	28 x 20 15/32
	TW2842	30 11/32 x 25	27 x 21 15/16	28 x 22 31/32	30 11/32 x 25 13/16	27 x 21 15/16	28 x 22 31/32
	TW2846 (1992 - 3/2017)	30 11/32 x 27	27 x 23 15/16	28 x 24 31/32	30 11/32 x 27 13/16	27 x 23 15/16	28 x 24 31/32
	TW2846 (4/2017 - Present)	30 11/32 x 27 1/2	27 x 24 7/16	28 x 25 15/32	30 11/32 x 27 5/16	27 x 23 7/16	28 x 24 15/32
	TW28410	30 11/32 x 29	27 x 25 15/16	28 x 26 31/32	30 11/32 x 29 13/16	27 x 25 15/16	28 x 26 31/32
	TW2852	30 11/32 x 31	27 x 27 15/16	28 x 28 31/32	30 11/32 x 31 13/16	27 x 27 15/16	28 x 28 31/32
	TW 2856E	30 11/32 x 33	27 x 29 15/16	28 x 30 31/32	30 11/32 x 32 31/32	27 x 29 15/16	28 x 30 31/32
	TW2856C (1992 - 3/2017)	30 11/32 x 27	27 x 23 15/16	28 x 24 31/32	30 11/32 x 39 13/16	27 x 35 15/16	28 x 36 31/32
	TW2856C (4/2017 - Present)	30 11/32 x 27 1/2	27 x 24 7/16	28 x 25 15/32	30 11/32 x 39 5/16	27 x 35 7/16	28 x 36 15/32
	TW28510	30 11/32 x 35	27 x 31 15/16	28 x 32 31/32	30 11/32 x 35 13/16	27 x 31 15/16	28 x 32 31/32
TW2862	30 11/32 x 37	27 x 33 15/16	28 x 34 31/32	30 11/32 x 37 13/16	27 x 33 15/16	28 x 34 31/32	
210	TW210210	32 11/32 x 17	29 x 13 15/16	30 x 14 31/32	32 11/32 x 17 13/16	29 x 13 15/16	30 x 14 31/32
	TW21032	32 11/32 x 19	29 x 15 15/16	30 x 16 31/32	32 11/32 x 19 13/16	29 x 15 15/16	30 x 16 31/32
	TW21036	32 11/32 x 21	29 x 17 15/16	30 x 18 31/32	32 11/32 x 21 13/16	29 x 17 15/16	30 x 18 31/32
	TW210310 (1992 - 8/2017)	32 11/32 x 23	29 x 19 15/16	30 x 20 31/32	32 11/32 x 23 13/16	29 x 19 15/16	30 x 20 31/32
	TW210310 (9/2017 - Present)	32 11/32 x 23 1/2	29 x 20 7/16	30 x 21 15/32	32 11/32 x 23 5/16	29 x 19 7/16	30 x 20 15/32
	TW21042	32 11/32 x 25	29 x 21 15/16	30 x 22 31/32	32 11/32 x 25 13/16	29 x 21 15/16	30 x 22 31/32
	TW21046 (1992 - 3/2017)	32 11/32 x 27	29 x 23 15/16	30 x 24 31/32	32 11/32 x 27 13/16	29 x 23 15/16	30 x 24 31/32
	TW21046 (4/2017 - Present)	32 11/32 x 27 1/2	29 x 24 7/16	30 x 25 15/32	32 11/32 x 27 5/16	29 x 23 7/16	30 x 24 15/32
	TW210410	32 11/32 x 29	29 x 25 15/16	30 x 26 31/32	32 11/32 x 29 13/16	29 x 25 15/16	30 x 26 31/32
	TW21052	32 11/32 x 31	29 x 27 15/16	30 x 28 31/32	32 11/32 x 31 13/16	29 x 27 15/16	30 x 28 31/32
	TW21056E	32 11/32 x 33	29 x 29 15/16	30 x 30 31/32	32 11/32 x 32 31/32	29 x 29 15/16	30 x 30 31/32
	TW21056C (1992 - 3/2017)	32 11/32 x 27	29 x 23 15/16	30 x 24 31/32	32 11/32 x 39 13/16	29 x 35 15/16	30 x 36 31/32
	TW21056C (4/2017 - Present)	32 11/32 x 27 1/2	29 x 24 7/16	30 x 25 15/32	32 11/32 x 39 5/16	29 x 35 7/16	30 x 36 15/32
	TW210510	32 11/32 x 35	29 x 31 15/16	30 x 32 31/32	32 11/32 x 35 13/16	29 x 31 15/16	30 x 32 31/32
TW21062	32 11/32 x 37	29 x 33 15/16	30 x 34 31/32	32 11/32 x 37 13/16	29 x 33 15/16	30 x 34 31/32	

400 Series Tilt-Wash PG Upgrade Windows (2003 to Present)

DP Upgrade Windows

Sash

Unit Size	Upper Sash			Lower Sash			
Unit No.	Overall Sash (w x h)	Unobstructed Glass (w x h)	Actual Glass (w x h)	Overall Sash (w x h)	Unobstructed Glass (w x h)	Actual Glass (w x h)	
30	TW30210	34 ¹¹ / ₃₂ × 17	31 × 13 ¹⁵ / ₁₆	32 × 14 ³¹ / ₃₂	34 ¹¹ / ₃₂ × 17 ¹³ / ₁₆	31 × 13 ¹⁵ / ₁₆	32 × 14 ³¹ / ₃₂
	TW3032	34 ¹¹ / ₃₂ × 19	31 × 15 ¹⁵ / ₁₆	32 × 16 ³¹ / ₃₂	34 ¹¹ / ₃₂ × 19 ¹³ / ₁₆	31 × 15 ¹⁵ / ₁₆	32 × 16 ³¹ / ₃₂
	TW3036	34 ¹¹ / ₃₂ × 21	31 × 17 ¹⁵ / ₁₆	32 × 18 ³¹ / ₃₂	34 ¹¹ / ₃₂ × 21 ¹³ / ₁₆	31 × 17 ¹⁵ / ₁₆	32 × 18 ³¹ / ₃₂
	TW30310 (1992 - 8/2017)	34 ¹¹ / ₃₂ × 23	31 × 19 ¹⁵ / ₁₆	32 × 20 ³¹ / ₃₂	34 ¹¹ / ₃₂ × 23 ¹³ / ₁₆	31 × 19 ¹⁵ / ₁₆	32 × 20 ³¹ / ₃₂
	TW30310 (9/2017 - Present)	34 ¹¹ / ₃₂ × 23 ¹ / ₂	31 × 20 ⁷ / ₁₆	32 × 21 ¹⁵ / ₃₂	34 ¹¹ / ₃₂ × 23 ⁵ / ₁₆	31 × 19 ⁷ / ₁₆	32 × 20 ¹⁵ / ₃₂
	TW3042	34 ¹¹ / ₃₂ × 25	31 × 21 ¹⁵ / ₁₆	32 × 22 ³¹ / ₃₂	34 ¹¹ / ₃₂ × 25 ¹³ / ₁₆	31 × 21 ¹⁵ / ₁₆	32 × 22 ³¹ / ₃₂
	TW3046 (1992 - 3/2017)	34 ¹¹ / ₃₂ × 27	31 × 23 ¹⁵ / ₁₆	32 × 24 ³¹ / ₃₂	34 ¹¹ / ₃₂ × 27 ¹³ / ₁₆	31 × 23 ¹⁵ / ₁₆	32 × 24 ³¹ / ₃₂
	TW3046 (4/2017 - Present)	34 ¹¹ / ₃₂ × 27 ¹ / ₂	31 × 24 ⁷ / ₁₆	32 × 25 ¹⁵ / ₃₂	34 ¹¹ / ₃₂ × 27 ⁵ / ₁₆	31 × 23 ⁷ / ₁₆	32 × 24 ¹⁵ / ₃₂
	TW30410	34 ¹¹ / ₃₂ × 29	31 × 25 ¹⁵ / ₁₆	32 × 26 ³¹ / ₃₂	34 ¹¹ / ₃₂ × 29 ¹³ / ₁₆	31 × 25 ¹⁵ / ₁₆	32 × 26 ³¹ / ₃₂
	TW3052	34 ¹¹ / ₃₂ × 31	31 × 27 ¹⁵ / ₁₆	32 × 28 ³¹ / ₃₂	34 ¹¹ / ₃₂ × 31 ¹¹ / ₆₄	31 × 27 ¹⁵ / ₁₆	32 × 28 ³¹ / ₃₂
	TW3056E	34 ¹¹ / ₃₂ × 33	31 × 29 ¹⁵ / ₁₆	32 × 30 ³¹ / ₃₂	34 ¹¹ / ₃₂ × 32 ³¹ / ₃₂	31 × 29 ¹⁵ / ₁₆	32 × 30 ³¹ / ₃₂
	TW3056C (1992 - 3/2017)	34 ¹¹ / ₃₂ × 27	31 × 23 ¹⁵ / ₁₆	32 × 24 ³¹ / ₃₂	34 ¹¹ / ₃₂ × 39 ¹³ / ₁₆	31 × 35 ¹⁵ / ₁₆	32 × 36 ³¹ / ₃₂
	TW3056C (4/2017 - Present)	34 ¹¹ / ₃₂ × 27 ¹ / ₂	31 × 24 ⁷ / ₁₆	32 × 25 ¹⁵ / ₃₂	34 ¹¹ / ₃₂ × 39 ⁵ / ₁₆	31 × 35 ⁷ / ₁₆	32 × 36 ¹⁵ / ₃₂
	TW30510	34 ¹¹ / ₃₂ × 35	31 × 31 ¹⁵ / ₁₆	32 × 32 ³¹ / ₃₂	34 ¹¹ / ₃₂ × 35 ¹³ / ₆₄	31 × 31 ¹⁵ / ₁₆	32 × 32 ³¹ / ₃₂
TW3062	34 ¹¹ / ₃₂ × 37	31 × 33 ¹⁵ / ₁₆	32 × 34 ³¹ / ₃₂	34 ¹¹ / ₃₂ × 37 ¹³ / ₁₆	31 × 33 ¹⁵ / ₁₆	32 × 34 ³¹ / ₃₂	
34	TW34210	38 ¹¹ / ₃₂ × 17	35 × 13 ¹⁵ / ₁₆	36 × 14 ³¹ / ₃₂	38 ¹¹ / ₃₂ × 17 ¹³ / ₁₆	35 × 13 ¹⁵ / ₁₆	36 × 14 ³¹ / ₃₂
	TW3432	38 ¹¹ / ₃₂ × 19	35 × 15 ¹⁵ / ₁₆	36 × 16 ³¹ / ₃₂	38 ¹¹ / ₃₂ × 19 ¹³ / ₁₆	35 × 15 ¹⁵ / ₁₆	36 × 16 ³¹ / ₃₂
	TW3436	38 ¹¹ / ₃₂ × 21	35 × 17 ¹⁵ / ₁₆	36 × 18 ³¹ / ₃₂	38 ¹¹ / ₃₂ × 21 ¹³ / ₁₆	35 × 17 ¹⁵ / ₁₆	36 × 18 ³¹ / ₃₂
	TW34310 (1992 - 8/2017)	38 ¹¹ / ₃₂ × 23	35 × 19 ¹⁵ / ₁₆	36 × 20 ³¹ / ₃₂	38 ¹¹ / ₃₂ × 23 ¹³ / ₁₆	35 × 19 ¹⁵ / ₁₆	36 × 20 ³¹ / ₃₂
	TW34310 (9/2017 - Present)	38 ¹¹ / ₃₂ × 23 ¹ / ₂	35 × 20 ⁷ / ₁₆	36 × 21 ¹⁵ / ₃₂	38 ¹¹ / ₃₂ × 23 ⁵ / ₁₆	35 × 19 ⁷ / ₁₆	36 × 20 ¹⁵ / ₃₂
	TW3442	38 ¹¹ / ₃₂ × 25	35 × 21 ¹⁵ / ₁₆	36 × 22 ³¹ / ₃₂	38 ¹¹ / ₃₂ × 25 ¹³ / ₁₆	35 × 21 ¹⁵ / ₁₆	36 × 22 ³¹ / ₃₂
	TW3446 (1992 - 3/2017)	38 ¹¹ / ₃₂ × 27	35 × 23 ¹⁵ / ₁₆	36 × 24 ³¹ / ₃₂	38 ¹¹ / ₃₂ × 27 ¹³ / ₁₆	35 × 23 ¹⁵ / ₁₆	36 × 24 ³¹ / ₃₂
	TW3446 (4/2017 - Present)	38 ¹¹ / ₃₂ × 27 ¹ / ₂	35 × 24 ⁷ / ₁₆	36 × 25 ¹⁵ / ₃₂	38 ¹¹ / ₃₂ × 27 ⁵ / ₁₆	35 × 23 ⁷ / ₁₆	36 × 24 ¹⁵ / ₃₂
	TW34410	38 ¹¹ / ₃₂ × 29	35 × 25 ¹⁵ / ₁₆	36 × 26 ³¹ / ₃₂	38 ¹¹ / ₃₂ × 29 ¹³ / ₁₆	35 × 25 ¹⁵ / ₁₆	36 × 26 ³¹ / ₃₂
	TW3452	38 ¹¹ / ₃₂ × 31	35 × 27 ¹⁵ / ₁₆	36 × 28 ³¹ / ₃₂	38 ¹¹ / ₃₂ × 31 ¹³ / ₆₄	35 × 27 ¹⁵ / ₁₆	36 × 28 ³¹ / ₃₂
	TW3456E	38 ¹¹ / ₃₂ × 33	35 × 29 ¹⁵ / ₁₆	36 × 30 ³¹ / ₃₂	38 ¹¹ / ₃₂ × 33 ¹ / ₆₄	35 × 29 ¹⁵ / ₁₆	36 × 30 ³¹ / ₃₂
	TW3456C (1992 - 3/2017)	38 ¹¹ / ₃₂ × 27	35 × 23 ¹⁵ / ₁₆	36 × 24 ³¹ / ₃₂	38 ¹¹ / ₃₂ × 39 ¹³ / ₁₆	35 × 35 ¹⁵ / ₁₆	36 × 36 ³¹ / ₃₂
	TW3456C (4/2017 - Present)	38 ¹¹ / ₃₂ × 27 ¹ / ₂	35 × 24 ⁷ / ₁₆	36 × 25 ¹⁵ / ₃₂	38 ¹¹ / ₃₂ × 39 ⁵ / ₁₆	35 × 35 ⁷ / ₁₆	36 × 36 ¹⁵ / ₃₂
	TW34510	38 ¹¹ / ₃₂ × 35	35 × 31 ¹⁵ / ₁₆	36 × 32 ³¹ / ₃₂	38 ¹¹ / ₃₂ × 35 ¹³ / ₁₆	35 × 31 ¹⁵ / ₁₆	36 × 32 ³¹ / ₃₂
TW3462	38 ¹¹ / ₃₂ × 37	35 × 33 ¹⁵ / ₁₆	36 × 34 ³¹ / ₃₂	38 ¹¹ / ₃₂ × 37 ¹³ / ₆₄	35 × 33 ¹⁵ / ₁₆	36 × 34 ³¹ / ₃₂	

Sash

Unit Size		Upper Sash			Lower Sash		
Unit No.	Overall Sash (w x h)	Unobstructed Glass (w x h)	Actual Glass (w x h)	Overall Sash (w x h)	Unobstructed Glass (w x h)	Actual Glass (w x h)	
38	TW38210	42 ¹¹ / ₃₂ × 17	39 × 13 ¹⁵ / ₁₆	40 × 14 ³¹ / ₃₂	42 ¹¹ / ₃₂ × 17 ¹³ / ₁₆	39 × 13 ¹⁵ / ₁₆	40 × 14 ³¹ / ₃₂
	TW3832	42 ¹¹ / ₃₂ × 19	39 × 15 ¹⁵ / ₁₆	40 × 16 ³¹ / ₃₂	42 ¹¹ / ₃₂ × 19 ¹³ / ₁₆	39 × 15 ¹⁵ / ₁₆	40 × 16 ³¹ / ₃₂
	TW3836	42 ¹¹ / ₃₂ × 21	39 × 17 ¹⁵ / ₁₆	40 × 18 ³¹ / ₃₂	42 ¹¹ / ₃₂ × 21 ¹³ / ₁₆	39 × 17 ¹⁵ / ₁₆	40 × 18 ³¹ / ₃₂
	TW38310 (1992 - 8/2017)	42 ¹¹ / ₃₂ × 23	39 × 19 ¹⁵ / ₁₆	40 × 20 ³¹ / ₃₂	42 ¹¹ / ₃₂ × 23 ¹³ / ₁₆	39 × 19 ¹⁵ / ₁₆	40 × 20 ³¹ / ₃₂
	TW38310 (9/2017 - Present)	42 ¹¹ / ₃₂ × 23 ¹ / ₂	39 × 20 ⁷ / ₁₆	40 × 21 ¹⁵ / ₃₂	42 ¹¹ / ₃₂ × 23 ⁵ / ₁₆	39 × 19 ⁷ / ₁₆	40 × 20 ¹⁵ / ₃₂
	TW3842	42 ¹¹ / ₃₂ × 25	39 × 21 ¹⁵ / ₁₆	40 × 22 ³¹ / ₃₂	42 ¹¹ / ₃₂ × 25 ¹³ / ₁₆	39 × 21 ¹⁵ / ₁₆	40 × 22 ³¹ / ₃₂
	TW3846 (1992 - 3/2017)	42 ¹¹ / ₃₂ × 27	39 × 23 ¹⁵ / ₁₆	40 × 24 ³¹ / ₃₂	42 ¹¹ / ₃₂ × 27 ¹³ / ₁₆	39 × 23 ¹⁵ / ₁₆	40 × 24 ³¹ / ₃₂
	TW3846 (4/2017 - Present)	42 ¹¹ / ₃₂ × 27 ¹ / ₂	39 × 24 ⁷ / ₁₆	40 × 25 ¹⁵ / ₃₂	42 ¹¹ / ₃₂ × 27 ⁵ / ₁₆	39 × 23 ⁷ / ₁₆	40 × 24 ¹⁵ / ₃₂
	TW38410	42 ¹¹ / ₃₂ × 29	39 × 25 ¹⁵ / ₁₆	40 × 26 ³¹ / ₃₂	42 ¹¹ / ₃₂ × 29 ¹³ / ₁₆	39 × 25 ¹⁵ / ₁₆	40 × 26 ³¹ / ₃₂
	TW3852	42 ¹¹ / ₃₂ × 31	39 × 27 ¹⁵ / ₁₆	40 × 28 ³¹ / ₃₂	42 ¹¹ / ₃₂ × 31 ¹³ / ₁₆	39 × 27 ¹⁵ / ₁₆	40 × 28 ³¹ / ₃₂
	TW3856E	42 ¹¹ / ₃₂ × 33	39 × 29 ¹⁵ / ₁₆	40 × 30 ³¹ / ₃₂	42 ¹¹ / ₃₂ × 33 ¹ / ₆₄	39 × 29 ¹⁵ / ₁₆	40 × 30 ³¹ / ₃₂
	TW3856C (1992 - 3/2017)	42 ¹¹ / ₃₂ × 27	39 × 23 ¹⁵ / ₁₆	40 × 24 ³¹ / ₃₂	42 ¹¹ / ₃₂ × 39 ¹³ / ₁₆	39 × 35 ¹⁵ / ₁₆	40 × 36 ³¹ / ₃₂
	TW3856C (4/2017 - Present)	42 ¹¹ / ₃₂ × 27 ¹ / ₂	39 × 24 ⁷ / ₁₆	40 × 25 ¹⁵ / ₃₂	42 ¹¹ / ₃₂ × 39 ⁵ / ₁₆	39 × 35 ⁷ / ₁₆	40 × 36 ¹⁵ / ₃₂
	TW38510	42 ¹¹ / ₃₂ × 35	39 × 31 ¹⁵ / ₁₆	40 × 32 ³¹ / ₃₂	42 ¹¹ / ₃₂ × 35 ¹³ / ₁₆	39 × 31 ¹⁵ / ₁₆	40 × 32 ³¹ / ₃₂
TW3862	42 ¹¹ / ₃₂ × 37	39 × 33 ¹⁵ / ₁₆	40 × 34 ³¹ / ₃₂	42 ¹¹ / ₃₂ × 37 ¹³ / ₁₆	39 × 33 ¹⁵ / ₁₆	40 × 34 ³¹ / ₃₂	

Sash Graphic - Upper

Note:

See latest [Product Details](#). Configure through iQ+.

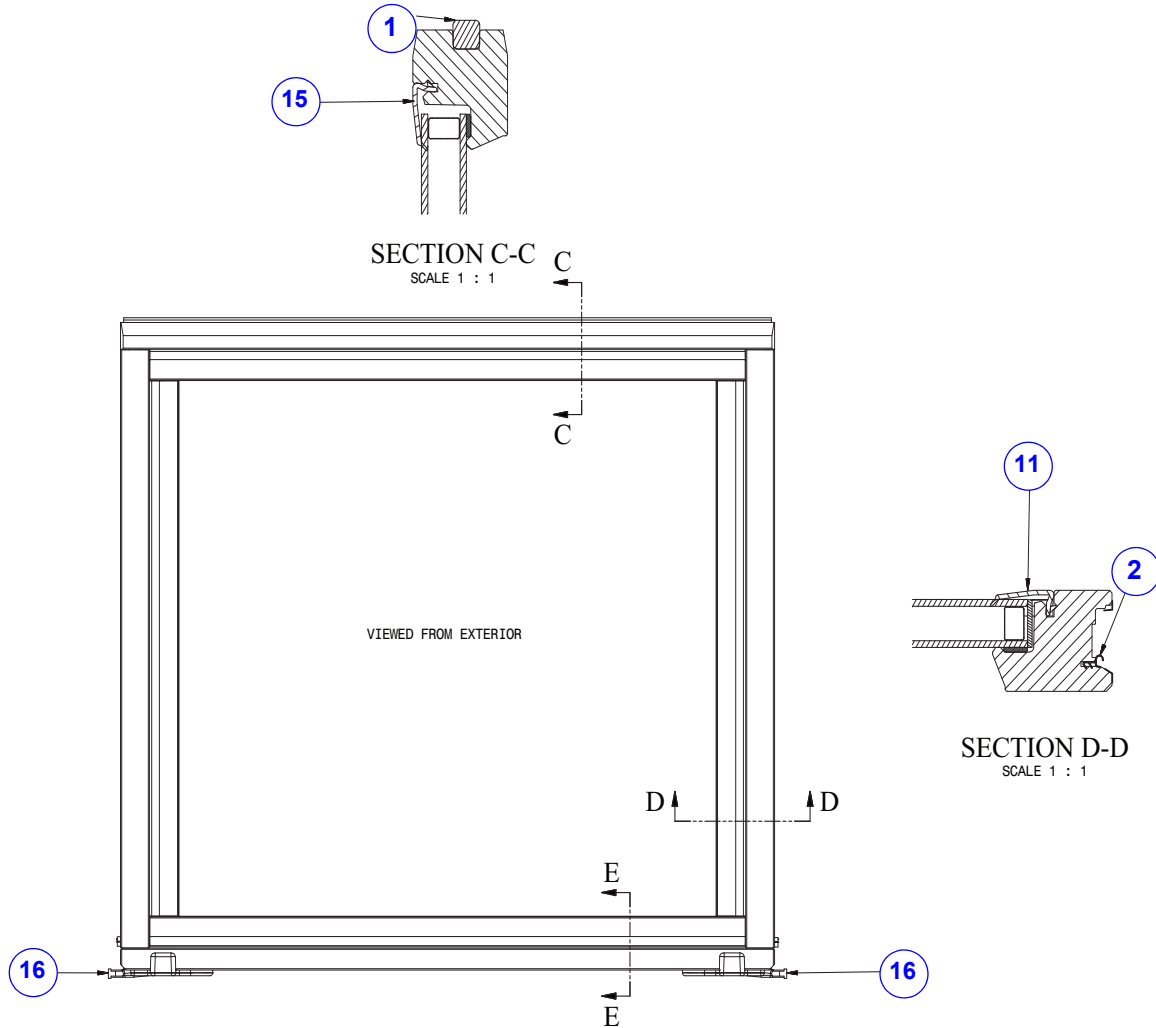

- 1. [Top Rail Weatherstrip](#)
- 2. [Stile Weatherstrip](#)
- 3. [Check Rail Weatherstrip](#)
- 4. [Lock Keeper](#)
- 6. Top Rail
- 7. Right Stile
- 8. Left Stile
- 9. Check Rail

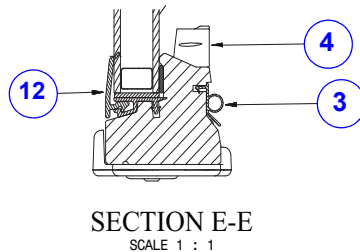

- 11. [Stile Glazing Bead](#)
- 12. [Check Rail Vinyl Glazing Bead](#)
- 13. Check Rail Bead Liner
- 14. Silicone Glazing
- 15. [Top Rail Glazing Bead](#)
- 16. [Pivot Pin](#)

Tilt-Wash DP Upgrade (TW) Upper Sash

Sash

Sash Options - Upper

Sash - Standard Window

Note:

Replacement sash for windows are made to order and can be configured through iQ+. Current glazings replace previous vintage glazings. Product ID label is located on the head jamb.



TEMPERED
 16 CFR 1201 II
 ANSI Z97.1-2009
 S GCC XXXX
 CIG-XX Xmm MM/DD/YR
 CAN/CGSB 12.1-M90

Exterior color options:
Interior species/finish/color options:
Glass options (See Logo/Etching Examples):

Low-E4®	Low-E4® HeatLock	Low-E4® Triple-Pane
Low-E4® SmartSun™	Low-E4® Smart-Sun HeatLock	Low-E4® Smart-Sun Triple-Pane
Low-E4® Passive Sun	Low-E4® Sun Heat-Lock	Low-E4® Enhanced Triple-Pane
Low-E4® Sun 3	Low-E4® HeatLock Tempered	Low-E4® Smart-Sun Enhanced Triple-Pane
Low-E4® Tempered	Dual Pane Clear	Low-E4® Enhanced Triple-Pane Heat-Lock
Low-E4® SmartSun Tempered	Cascade	Low-E4® Smart-Sun Enhanced Triple-Pane HeatLock
Low-E4® Passive Sun Tempered	Fern	
Low-E4® Sun Tempered	Reed	

To order, state:

Product ID (from product label, see [Service Guide 9051877](#))

OR

1. Unit or frame size (TW XXXX or frame W x H dimensions)
2. Unit sash ratio (Even, Cottage, Rev Cottage, SSR)
3. Description of part (Upper Sash)
4. Exterior color of sash
5. Hardware finish of keeper
6. Glazing/Grille type

Sash Graphic - Lower

Note:

See latest [Product Details](#). Configure through iQ+.

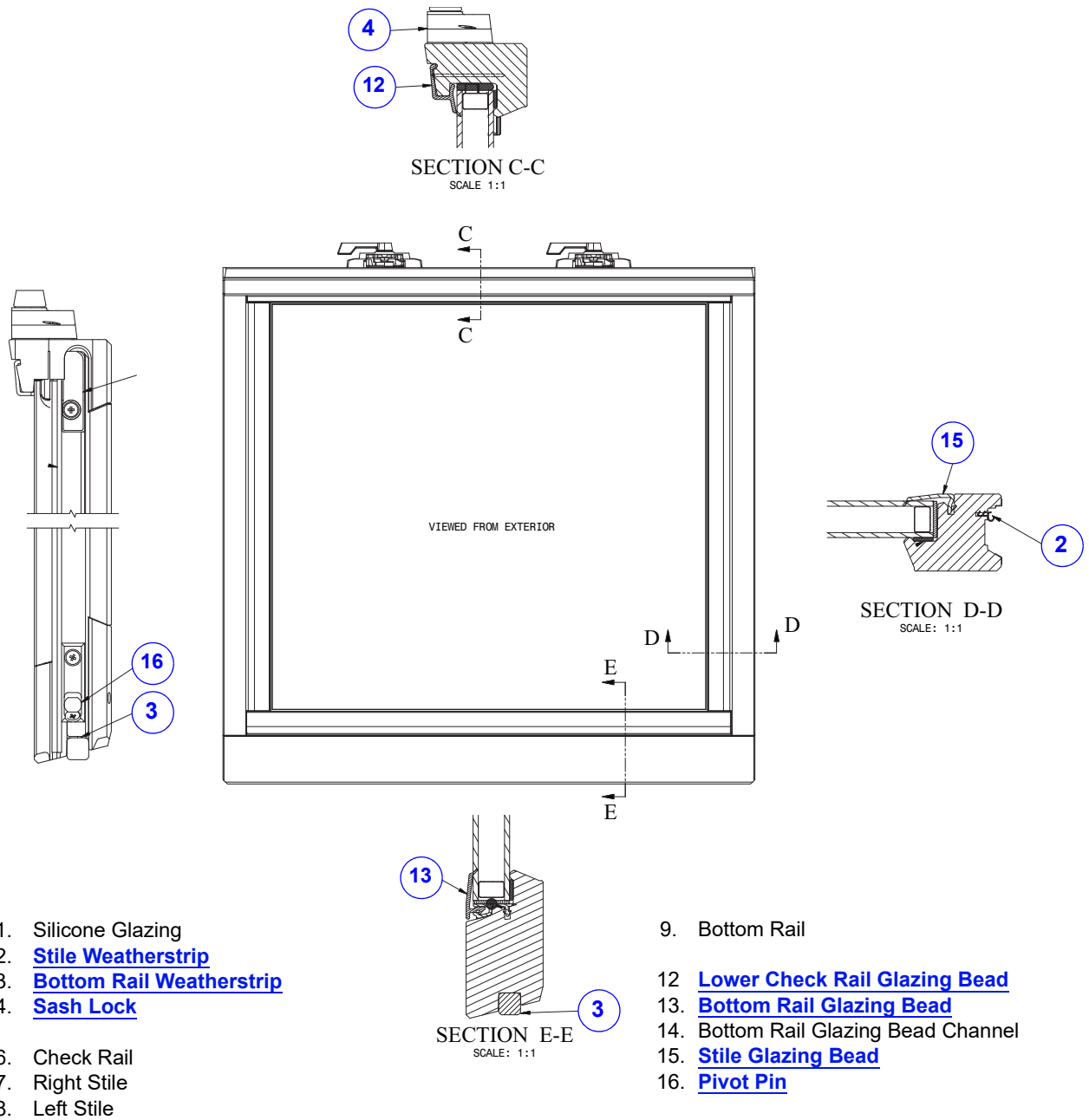

Tilt-Wash DP Upgrade (TW) Lower Sash

Sash

Sash Options - Lower

Sash - Standard Window

Note:

Replacement sash for windows are made to order and can be configured through iQ+. Current glazings replace previous vintage glazings. Product ID label is located on the head jamb.



TEMPERED
16 CFR 1201 II
ANSI Z97.1 2009
SGCC XXXX
CIG-XX Xmm MM/DD/YR
CAN/CGSB 12.1-M90

Exterior color options:

Interior species/finish/color options:

Glass options (See Logo/Etching Examples):

Low-E4®	Low-E4® HeatLock	Low-E4® Triple-Pane
Low-E4® SmartSun™	Low-E4® Smart-Sun HeatLock	Low-E4® Smart-Sun Triple-Pane
Low-E4® Passive Sun	Low-E4® Sun Heat-Lock	Low-E4® Enhanced Triple-Pane
Low-E4® Sun 3	Low-E4® HeatLock Tempered	Low-E4® Smart-Sun Enhanced Triple-Pane
Low-E4® Tempered	Dual Pane Clear	Low-E4® Enhanced Triple-Pane Heat-Lock
Low-E4® SmartSun Tempered	Cascade	Low-E4® Smart-Sun Enhanced Triple-Pane HeatLock
Low-E4® Passive Sun Tempered	Fern	
Low-E4® Sun Tempered	Reed	

To order, state:

Product ID (from product label, see [Service Guide 9051877](#))

OR

1. Unit or frame size (TW XXXX or frame W x H dimensions)
2. Unit sash ratio (Even, Cottage, Rev Cottage, SSR)
3. Description of part (Lower Sash)
4. Exterior color of sash
5. Hardware finish of keeper
6. Glazing/Grille type

400 Series Tilt-Wash PG Upgrade Windows (2003 to Present)

DP Upgrade Windows

Sash

Weatherstrip

Note:

See [Weatherstrip Replacement Video](#) (vintage top/bottom rail weatherstrip shown in video).

Weatherstrip - Top and Bottom Rail (10/2019 - Present) [Ref. No. 1 page 13](#) & [Ref. No. 3 page 15](#)

Note:

Cut to size. Replaces previous vintages of top/bottom rail weatherstrip.

Adhere with 1/8" bead of [Andersen Installation Sealant](#). See [Service Guide 9183983](#).

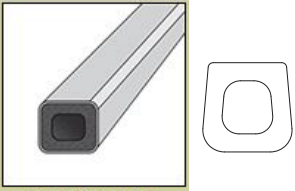
 <p>Top or Bottom Rail</p>		Unit No.	Dimensions	Black
		TW38	42 ⁹ / ₃₂	9181571

Weatherstrip - HDN / Upper Check Rail [Ref. No. 3 page 13](#)

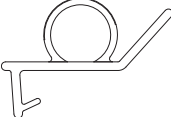
		Unit No.	Dimensions	Order No.
		TW18	18 ⁹ / ₃₂	1631836
		TW20	22 ⁹ / ₃₂	1631837
		TW24	26 ⁹ / ₃₂	1631838
		TW26	28 ⁹ / ₃₂	1631843
		TW28	30 ⁹ / ₃₂	1631839
		TW210	32 ⁹ / ₃₂	1631844
		TW30	34 ⁹ / ₃₂	1631840
		TW34	38 ⁹ / ₃₂	1631841
	TW38	42 ⁹ / ₃₂	1631842	

Sash

Weatherstrip - Side / Stile Ref. No. 2 page 13 & page 15				
	<p>Note: Ships as a quantity of one. The 310 and 46 height sizes are unique in length with two separate part numbers for the weatherstrip used on upper and lower sash. Other height sizes to be used with upper and lower sash. See Dealer Bulletin 61-16 for more details.</p>	Unit No.	Dimensions	Order No.
		TW210	16 ¹⁵ / ₁₆	1631540
		TW32	18 ¹⁵ / ₁₆	1631541
		TW36	20 ¹⁵ / ₁₆	1631560
		TW310 Lower <i>(9/2017 - Present)</i>	22 ⁷ / ₁₆	9168695
		TW310 <i>(5/2010 - 8/2017)</i>	22 ¹⁵ / ₁₆	1631542
		TW310 Upper <i>(9/2017 - Present)</i>	23 ⁷ / ₁₆	9168694
		TW42	24 ¹⁵ / ₁₆	1631543
		TW46 Lower <i>(4/2017 - Present)</i>	26 ⁷ / ₁₆	9162508
		TW46 <i>(5/2010 - 3/2017)</i>	26 ¹⁵ / ₁₆	1631544
		TW46 Upper <i>(4/2017 - Present)</i>	27 ⁷ / ₁₆	9161583
		TW410	28 ¹⁵ / ₁₆	1631561
		TW52	30 ¹⁵ / ₁₆	1631545
		TW56E	32 ¹⁵ / ₁₆	1631563
		TW510	34 ¹⁵ / ₁₆	1631562
		TW62	36 ¹⁵ / ₁₆	1631547
		TW56C Lower <i>(4/2017 - Present)</i>	38 ⁷ / ₁₆	9162509
		TW56C	38 ¹⁵ / ₁₆	1631546
		TW56RC Upper <i>(4/2017 - Present)</i>	39 ⁷ / ₁₆	9161584
		72 in	72 ¹⁵ / ₁₆	1631514

400 Series Tilt-Wash PG Upgrade Windows (2003 to Present)

DP Upgrade Windows

Sash

Glazing Beads - High Performance / 5/8"

Note:

Glazing bead unit numbers/sizes not listed are available OBD. See [Replacement Video](#).

Glazing Bead - High-Performance / 5/8" / Top Rail

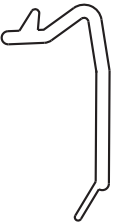
Note: Use on upper sash top rail.	Unit No.	Size	White	Terra-tone®	Sand-tone	Forest Green	Canvas	Dark Bronze	Black
	TW18	16 21/32	1650120	2732520	1152075	0313120	9033967	9073925	9127145
	TW20	20 21/32	1650121	2732521	1152076	0313121	9033968	9073926	9127146
	TW24	24 21/32	1650122	2732522	1152077	0313122	9033969	9073927	9127147
	TW26	26 21/32	1650127	2732527	1152128	0313127	9033970	9073928	9127148
	TW28	28 21/32	1650123	2732523	1152078	0313123	9033971	9073929	9127149
	TW210	30 21/32	1650128	2732528	1152129	0313128	9033972	9073930	9127150
	TW30	32 21/32	1650124	2732524	1152079	0313124	9033973	9073931	9127151
	TW34	36 21/32	1650125	2732525	1152080	0313125	9033974	9073932	9127152
TW38	40 21/32	1650126	2732526	1152081	0313126	9033975	9073933	9127153	

Glazing Bead - High-Performance / 5/8" / Upper Check / Bottom Rail

Note: Use on upper sash check rail and lower sash bottom rail.	Unit No.	Size	White	Terra-tone®	Sand-tone	Forest Green	Canvas	Dark Bronze	Black
	TW18	16 21/32	1650130	2732530	1152082	0313130	9033976	9073934	9127154
	TW20	20 21/32	1650131	2732531	1152083	0313131	9033977	9073935	9127155
	TW24	24 21/32	1650132	2732532	1152084	0313132	9033978	9073936	9127156
	TW26	26 21/32	1650137	2732529	1152145	0313129	9033979	9073937	9127157
	TW28	28 21/32	1650133	2732533	1152085	0313133	9033980	9073938	9127158
	TW210	30 21/32	1650138	2732537	1152146	0313137	9033981	9073939	9127159
	TW30	32 21/32	1650134	2732534	1152086	0313134	9033982	9073940	9127160
	TW34	36 21/32	1650135	2732535	1152087	0313135	9033983	9073941	9127161
TW38	40 21/32	1650136	2732536	1152088	0313136	9033984	9073942	9127162	

Sash

Glazing Bead - High-Performance / 5/8" / Lower Check Rail Ref. No. 12 page 15									
Note: Use on lower sash check rail.	Unit No.	Size	White	Terra-tone®	Sand-tone	Forest Green	Canvas	Dark	
								Bronze	Black
	TW18	16 21/32	1650140	2732540	1152089	0313140	9033946	9073904	9127124
	TW20	20 21/32	1650141	2732541	1152090	0313141	9033947	9073905	9127125
	TW24	24 21/32	1650142	2732542	1152091	0313142	9033948	9073906	9127126
	TW26	26 21/32	1650139	2732538	1152096	0313138	9033949	9073907	9127127
	TW28	28 21/32	1650143	2732543	1152092	0313143	9033950	9073908	9127128
	TW210	30 21/32	1650147	2732539	1152097	0313139	9033951	9073909	9127129
	TW30	32 21/32	1650144	2732544	1152093	0313144	9033952	9073910	9127130
	TW34	36 21/32	1650145	2732545	1152094	0313145	9033953	9073911	9127131
	TW38	40 21/32	1650146	2732546	1152095	0313146	9033954	9073912	9127132

Glazing Bead - High-Performance / 5/8" / Stile Ref. No. 11 page 13 & Ref. No. 15 page 15									
Note: Use on all stiles. The 310 and 46 height sizes are unique in length with two separate part numbers for the glazing bead used on upper and lower sash. Other height sizes to be used with upper and lower sash. See Dealer Bulletin 61-16 for more details.	Unit No.	Size	White	Terra-tone®	Sand-tone	Forest Green	Canvas	Dark	
								Bronze	Black
	TW210	14 1/16	1650402	2732802	1152046	3851180	9033955	9073913	9127133
	TW32	16 1/16	1650404	2732804	1152048	3851182	9033956	9073914	9127134
	TW36	18 1/16	1650405	2732805	1152049	3851184	9033957	9073915	9127135
	TW310 Lower <i>(9/2017 - Present)</i>	19 9/16	9168698	9168682	9168681	9168683	9168684	9168685	9168686
	TW310 <i>(1992 - 8/2017)</i>	20 1/16	1650406	2732806	1152050	3851186	9033958	9073916	9127136
	TW310 Upper <i>(9/2017 - Present)</i>	20 9/16	9168697	9168662	9168657	9168664	9168666	9168669	9168672
	TW42	22 1/16	1650408	2732808	1152052	3851188	9033959	9073917	9127137
	TW46 Lower <i>(4/2017 - Present)</i>	23 9/16	9161587	9161576	9161575	9161574	9161572	9161573	9161571
	TW46 <i>(1992 - 3/2017)</i>	24 1/16	1650410	2732810	1152054	3851190	9033960	9073918	9127138
	TW46 Upper <i>(4/2017 - Present)</i>	24 9/16	9161585	9161536	9161535	9161534	9161532	9161533	9161531
	TW410	26 1/16	1650411	2732811	1152055	3851194	9033961	9073919	9127139
	TW52	28 1/16	1650412	2732812	1152056	3851196	9033962	9073920	9127140
	TW56E	30 1/16	1650415	2732813	1152057	3851198	9033963	9073921	9127141
	TW510	32 1/16	1650413	2732815	1152059	3851200	9033964	9073922	9127142
	TW62	34 1/16	1650416	2732816	1152060	3851202	9033965	9073923	9127143
	TW56C Lower <i>(4/2017 - Present)</i>	35 9/16	9161588	9161582	9161581	9161580	9161578	9161579	9161577
	TW56C <i>(1992 - 3/2017)</i>	36 1/16	1650414	2732814	1152058	3851204	9033966	9073924	9127144
	TW56RC Upper <i>(4/2017 - Present)</i>	36 9/16	9161586	9161542	9161541	9161540	9161538	9161539	9161537

400 Series Tilt-Wash PG Upgrade Windows (2003 to Present)

DP Upgrade Windows

Sash

Glazing Beads - HDN

Glazing Bead - HDN / Top Rail with End Cap

Note:

Use with units that have HDN grilles beginning in June 2002. Use on upper sash top rail.

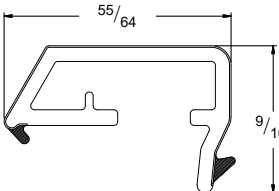
	Unit No.	Size	White	Terra-tone®	Sand-tone	Forest Green	Canvas	Dark Bronze	Black
	TW18	16 ²¹ / ₃₂	1690348	2705170	1102022	0300187	9034012	9073967	9127221
	TW20	20 ²¹ / ₃₂	1690349	2705171	1102023	0300188	9034011	9073966	9127220
	TW24	24 ²¹ / ₃₂	1690350	2705172	1102024	0300189	9034010	9073965	9127219
	TW26	26 ²¹ / ₃₂	1690351	2705173	1102025	0300190	9034009	9073964	9127218
	TW28	28 ²¹ / ₃₂	1690352	2705174	1102026	0300191	9034008	9073963	9127217
	TW210	30 ²¹ / ₃₂	1690353	2705175	1102027	0300192	9034007	9073962	9127216
	TW30	32 ²¹ / ₃₂	1690354	2705176	1102028	0300193	9034006	9073961	9127215
	TW34	36 ²¹ / ₃₂	1690355	2705177	1102029	0300194	9034005	9073960	9127214
TW38	40 ²¹ / ₃₂	1690356	2705178	1102030	0300195	9034004	9073959	9127213	

Bead - HDN / Upper Check / Bottom Rail with End Cap

Note:

Use with units that have HDN grilles beginning in June 2002. Use on upper sash check rail and lower sash bottom rail.

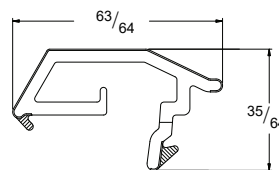
	Unit No.	Size	White	Terra-tone®	Sand-tone	Forest Green	Canvas	Dark Bronze	Black
	TW18	16 ²¹ / ₃₂	1690334	2705156	1102008	0300173	9034021	9073976	9127187
	TW20	20 ²¹ / ₃₂	1690335	2705157	1102009	0300174	9034020	9073975	9127186
	TW24	24 ²¹ / ₃₂	1690336	2705158	1102010	0300175	9034019	9073974	9127185
	TW26	26 ²¹ / ₃₂	1690337	2705159	1102011	0300176	9034018	9073973	9127184
	TW28	28 ²¹ / ₃₂	1690338	2705160	1102012	0300177	9034017	9073972	9127183
	TW210	30 ²¹ / ₃₂	1690339	2705161	1102013	0300178	9034016	9073971	9127182
	TW30	32 ²¹ / ₃₂	1690340	2705162	1102014	0300179	9034015	9073970	9127181
	TW34	36 ²¹ / ₃₂	1690341	2705163	1102015	0300180	9034014	9073969	9127180
TW38	40 ²¹ / ₃₂	1690342	2705164	1102016	0300181	9034013	9073968	9127179	

Sash

Glazing Bead - HDN / Lower Check Rail

Note:

Use with units that have HDN grilles beginning in June 2002. Use on lower sash check rail.

	Unit No.	Size	White	Terra-tone®	Sand-tone	Forest Green	Canvas	Dark Bronze	Black
	TW18	16 ²¹ / ₃₂	1690362	2705184	1102036	0300202	9034030	9073985	9127196
	TW20	20 ²¹ / ₃₂	1690363	2705185	1102037	0300203	9034029	9073984	9127195
	TW24	24 ²¹ / ₃₂	1690364	2705186	1102038	0300204	9034028	9073983	9127194
	TW26	26 ²¹ / ₃₂	1690365	2705187	1102039	0300205	9034027	9073982	9127193
	TW28	28 ²¹ / ₃₂	1690366	2705188	1102040	0300206	9034026	9073981	9127192
	TW210	30 ²¹ / ₃₂	1690367	2705189	1102041	0300207	9034025	9073980	9127191
	TW30	32 ²¹ / ₃₂	1690368	2705190	1102042	0300208	9034024	9073979	9127190
	TW34	36 ²¹ / ₃₂	1690369	2705191	1102043	0300209	9034023	9073978	9127189
	TW38	40 ²¹ / ₃₂	1690370	2705192	1102044	0300210	9034022	9073977	9127188

400 Series Tilt-Wash PG Upgrade Windows (2003 to Present)

DP Upgrade Windows

Sash

Sash Hardware

Lock and Keeper Kit (4/2007 - Present)

Note:

Replaces previous vintages.

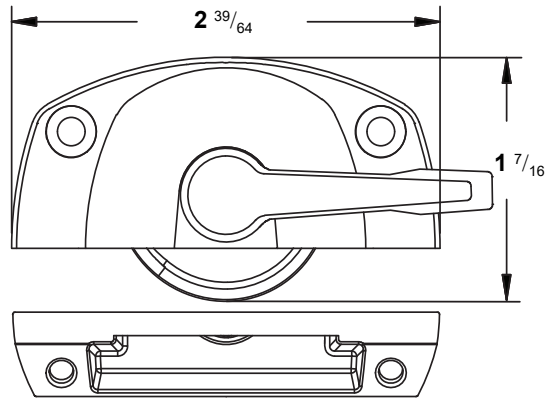

Kit includes:

- (1) Lock
 - (1) Keeper
 - (4) Screws
- Lock and keeper are metal.

Color	Order No.
Stone	2743367
White	1690603
Gold Dust	9021820
Black	9021819
Bright Brass	N/A
Satin Nickel	9021824
Oil Rubbed Bronze	9021823
Antique Brass	N/A

Screw - Sash Lock and Keeper (4/2007 - Present)

Description	Color	Order No.
6-10 x 3/4 PLS 2 PH SP Oval Stl ZD	Stone	3620225
	White	3620226
	Gold Dust	9004465
	Black	9004466
	Bright Brass	9004467
	Satin Nickel	9004468
	Oil-Rubbed Bronze	9004469
	Antique Brass	9004470
	Brushed Chrome	9004471
Polished Chrome	9004472	

Shim Kit - Lock and Keeper / Metal (4/2007 - Present)

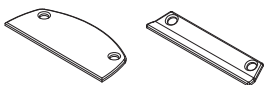

Color	Order No.
Stone	2743029
White	1690671

Sash

Sash Hardware / Opening Control Device Kit

Opening Control Device Kit / Factory Installed

Note:

See [Dealer Bulletin 56-17](#) for more information.

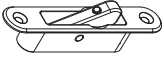
	Kit includes: Two opening control devices, two boots, screws, bumpers and instructions.	Finish	Order No.
		Stone	9152278
		White	9152277
		Black	9152281

Screw - Opening Control Device Kit / Factory Installed

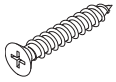
	Description: 6-18 x 7/8" PHFH TYP A Tapping	Color	Order No.
		Stone	9152280
		White	9152279
		Black	9173547

400 Series Tilt-Wash PG Upgrade Windows (2003 to Present)

DP Upgrade Windows

Sash

Sash Components / Miscellaneous

Pivot - Sash

Note:

Used on lower sash 2003 - present. Used on upper sash from 2003 - 2018.

		Order No.
		1643018

Screw - Sash Pivot

	Description	Order No.
	6-10 x 3/4 SCR5 Oval Hd	3621996

Structural Pivot Pin (2018 - Present)

Note:

Used on upper sash beginning in 2018.

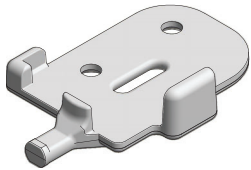
	White		Canvas		Sandtone		Terratone®	
	Left	Right	Left	Right	Left	Right	Left	Right
	9174238	9174239	9174240	9174241	9174248	9174249	9174246	9174247
	Forest Green		Dark Bronze		Black			
	Left	Right	Left	Right	Left	Right		
	9174248	9174249	9174242	9174243	9174250	9174251		

Screw - Structural Pivot Pin

	Description	Neutral
	10-12 X 1.000 TYP 17 PH FL 302 SS PASS	2579413

Sash Balancers

Balancers - Tab and Shoe Illustration

Balancer - Tab and Shoe Illustration

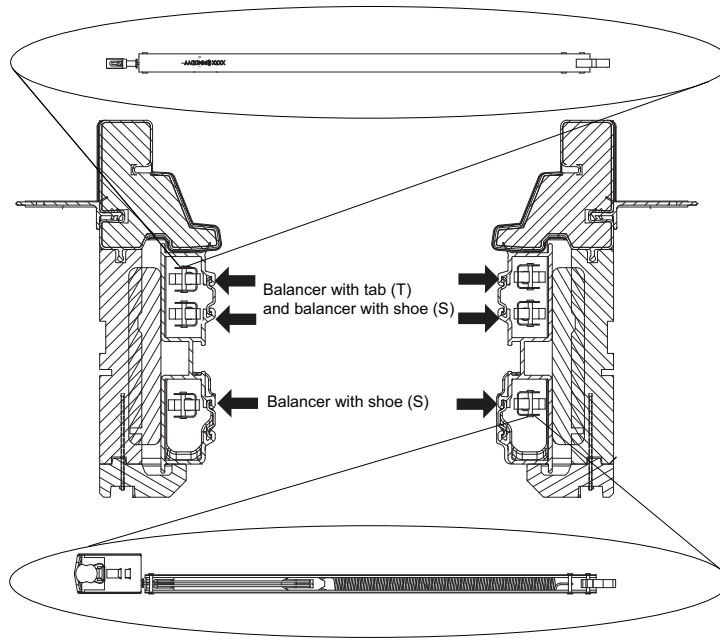

400 Series Tilt-Wash PG Upgrade Windows (2003 to Present)

DP Upgrade Windows

Sash Balancers

Balancer Usage Chart (1992 - Present)

Note:

T = Balancer with tab.

S = Balancer with shoe.

S & T = Two balancers used: one with shoe and one with tab.

These charts are used to identify balancers for TW (Tilt-Wash) double hung units.

The following charts show the balancers that you need for the upper and the lower sash. A complete unit will use either 4, 6 or 8 balancers.

- If one number is listed this balancer is used on the upper sash as well as the lower sash.
- If two balancer sizes are listed, you need both of those balancers for the upper and both for the lower sash.
- Each sash will use either two (one on each side) or four (two on each side) balancers on each sash, see [page 26](#).
- If an S & T follows a number, you need two balancers for the upper sash, one with a shoe and one with a tab and two for the lower sash, one with a shoe and one with a tab.
- See Stormwatch Section to identify balancer chart for glass types not listed in Chart 1 through 4.
- Balancer may be etched with 3 or 4 digit number.
- 46 sash height changed 4/2017
- 310 sash height changed 9/2017

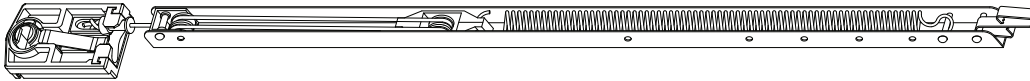

Tilt-Wash Balancer (Block and Tackle with Shoe)

Beginning in April of 2012, glass may be etched with 2.2 or 3.0 etchings. If you have a sash made prior to April of 2012 use glass type to identify balancer needed. If you have a sash made after April 2012 use glass type as well as any 2.2 or 3.0 etching around logo. Glass with 2.2 etchings will use Chart 1 or 3, glass with 3.0 etchings will use Chart 2 or 4. Glass type HP, HP Sun, HP SmartSun™ and HP PassiveSun™ manufactured prior to April 2012 will not have 2.2 etching, but will use Chart 1 or 3.

2.2 Etching



3.0 Etching



Sash Balancers

BALANCER USAGE CHART 1 - TW UNITS (1992 - Present)							
HP (2.2)							
HP Sun (2.2)							
HP SmartSun (2.2)							
HP Passive Sun (2.2)							
Unit No.	Upper and Lower Sash		Order No.	Unit No.	Upper and Lower Sash		
	Balancer				Balancer		
18	TW18210	TW414 ^S	See Charts	20	TW20210	TW414 ^S	See Charts
	TW1832	TW416 ^S			TW2032	TW516 ^S	
	TW1836	TW418 ^S			TW2036	TW518 ^S	
	TW18310 <i>(9/2017 - Present)</i>	TW520.35 ^S			TW20310 <i>(9/2017 - Present)</i>	TW620.35 ^S	
	TW18310 <i>(1992 - 8/2017)</i>	TW520 ^S			TW20310 <i>(1992 - 8/2017)</i>	TW520 ^S	
	TW1842	TW522 ^S			TW2042	TW622	
	TW1846 <i>(4/2017 - Present)</i>	TW524.35 ^S			TW2046 <i>(4/2017 - Present)</i>	TW624.35 ^S	
	TW1846 <i>(1992 - 3/2017)</i>	TW524 ^S			TW2046 <i>(1992 - 3/2017)</i>	TW624 ^S	
	TW18410	TW626 ^S			TW20410	TW726 ^S	
	TW1852	TW628 ^S			TW2052	TW728 ^S	
	TW1856 <i>(4/2017 - Present)</i>	Upper:TW524.35 ^S Lower:TW730 ^S			TW2056 <i>(4/2017 - Present)</i>	Upper:TW624.35 ^S Lower:TW830 ^S	
	TW1856 <i>(1992 - 3/2017)</i>	Upper:TW524 ^S Lower:TW730 ^S			TW2056 <i>(1992 - 3/2017)</i>	Upper:TW624 ^S Lower:TW830 ^S	
	TW1856E	TW630 ^S			TW2056E	TW730 ^S	
	TW18510	TW732 ^S			TW20510	TW832 ^S	
	TW1862	TW734 ^S			TW2062	TW834 ^S	

400 Series Tilt-Wash PG Upgrade Windows (2003 to Present)

DP Upgrade Windows

Sash Balancers

BALANCER USAGE CHART 1 - TW UNITS (1992 - Present)							
HP (2.2)							
HP Sun (2.2)							
HP SmartSun (2.2)							
HP Passive Sun (2.2)							
	Unit No.	Upper and Lower Sash Balancer	Order No.		Upper and Lower Sash Balancer	Order No.	
24	TW24210	TW514 ^s	See Charts	26	TW26210	TW514 ^s	See Charts
	TW2432	TW516 ^s			TW2632	TW616 ^s	
	TW2436	TW618 ^s			TW2636	TW618 ^s	
	TW24310 <i>(9/2017 - Present)</i>	TW620.35 ^s			TW26310 <i>(9/2017 - Present)</i>	TW720.35 ^s	
	TW24310 <i>(1992 - 8/2017)</i>	TW620 ^s			TW26310 <i>(1992 - 8/2017)</i>	TW720 ^s	
	TW2442	TW722 ^s			TW2642	TW722 ^s	
	TW2446 <i>(4/2017 - Present)</i>	TW724.35 ^s			TW2646 <i>(4/2017 - Present)</i>	TW824.35 ^s	
	TW2446 <i>(1992 - 3/2017)</i>	TW724 ^s			TW2646 <i>(1992 - 3/2017)</i>	TW824 ^s	
	TW24410	TW826 ^s			TW26410	TW826 ^s	
	TW2452	TW828 ^s			TW2652	TW928 ^s	
	TW2456 <i>(4/2017 - Present)</i>	Upper:TW724.35 ^s Lower:TW1030 ^s			TW2656 <i>(4/2017 - Present)</i>	Upper:TW824.35 ^s Lower:TW1030 ^s	
	TW2456C <i>(1992 - 3/2017)</i>	Upper:TW724.35 ^s Lower:TW1030 ^s			TW2656 <i>(1992 - 3/2017)</i>	Upper: TW724 ^s Lower: TW1030 ^s	
	TW2456E	TW930 ^s			TW2656E	TW930 ^s	
	TW24510	TW930 ^s			TW26510	TW1032 ^s	
TW2462	TW934 ^s	TW2662	TW1034 ^s				

Sash Balancers

BALANCER USAGE CHART 1 - TW UNITS (1992 - Present)					
HP (2.2)					
HP Sun (2.2)					
HP SmartSun (2.2)					
HP Passive Sun (2.2)					
Unit No.	Upper and Lower Sash	Order No.	Unit No.	Upper and Lower Sash	Order No.
	Balancer			Balancer	
28	TW2828	See Charts	210	TW210210	See Charts
	TW28210			TW21032	
	TW2832			TW21036	
	TW2836			TW210310 <i>(9/2017 - Present)</i>	
	TW28310 <i>(9/2017 - Present)</i>			TW210310 <i>(1992 - 8/2017)</i>	
	TW28310 <i>(1992 - 8/2017)</i>			TW21042	
	TW2842			TW21046 <i>(4/2017 - Present)</i>	
	TW2846 <i>(4/2017 - Present)</i>			TW21046 <i>(1992 - 3/2017)</i>	
	TW2846 <i>(1992 - 3/2017)</i>			TW210410	
	TW28410			TW21052	
	TW2852			TW21056 <i>(4/2017 - Present)</i>	
	TW2856 <i>(4/2017 - Present)</i>			TW21056 <i>(1992 - 3/2017)</i>	
	TW2856 <i>(1992 - 3/2017)</i>			TW21056E	
	TW2856E			TW210510	
	TW28510			TW21062	
TW2862					

400 Series Tilt-Wash PG Upgrade Windows (2003 to Present)

DP Upgrade Windows

Sash Balancers

BALANCER USAGE CHART 1 - TW UNITS (1992 - Present)					
HP (2.2) HP Sun (2.2) HP SmartSun (2.2) HP Passive Sun (2.2)					
Unit No.	Upper and Lower Sash	Order No.	Unit No.	Upper and Lower Sash	Order No.
	Balancer			Balancer	
30	TW30210	TW614 ^s	See Charts	TW34210	TW714 ^s
	TW3032	TW716 ^s		TW3432	TW716 ^s
	TW3036	TW718 ^s		TW3436	TW818 ^s
	TW30310 (9/2017 - Present)	TW820.35 ^s		TW34310 (9/2017 - Present)	TW920.35 ^s
	TW30310 (1992 - 8/2017)	TW820 ^s		TW34310 (1992 - 8/2017)	TW920 ^s
	TW3042	TW922 ^s		TW3442	TW922 ^s
	TW3046 (4/2017 - Present)	TW924.35 ^s TW924.35 ^s		TW3446 (4/2017 - Present)	TW1024.35 ^s TW1024.35 ^s
	TW3046 (1992 - 3/2017)	TW924 ^s		TW3446 (1992 - 3/2017)	TW1024 ^s
	TW3048	TW925 ^s		TW34410	TW1126 ^s
	TW30410	TW1026 ^s		TW3452	TW1128 ^s
	TW3052	TW1028 ^s		TW3456 (4/2017 - Present)	Upper:TW1024.35 ^s Lower:830 ^s Lower:630 ^T
	TW3056 (4/2017 - Present)	Upper:TW924.35 ^s Lower:TW1230 ^s		TW3456 (1992 - 3/2017)	Upper: TW1024 Lower: TW630 ^T Lower: TW830 ^s
	TW3056 (1992 - 3/2017)	Upper:TW924 ^s Lower:TW1230 ^s		TW3456E	TW1230 ^s
	TW3056E	TW1130 ^s		TW34510	TW1332 ^s
	TW30510	TW1232 ^s		TW3462	TW1334 ^s
TW3062	TW1234 ^s				

Sash Balancers

BALANCER USAGE CHART 1 - TW UNITS (1992 - Present)						
HP (2.2)						
HP Sun (2.2)						
HP SmartSun (2.2)						
HP Passive Sun (2.2)						
Unit No.	Upper and Lower Sash		Order No.	Unit No.	Upper and Lower Sash	
	Balancer				Balancer	
38	TW38210	TW714 ^S	See Charts			
	TW3832	TW816 ^S				
	TW3836	TW918 ^S				
	TW38310 <i>(9/2017 - Present)</i>	TW1020.35 ^S				
	TW38310 <i>(1992 - 8/2017)</i>	TW1020 ^S				
	TW3842	TW1022 ^S				
	TW3846 <i>(4/2017 - Present)</i>	TW1124.35 ^S				
	TW3846 <i>(1992 - 3/2017)</i>	TW1124 ^S				
	TW38410	TW1226 ^S				
	TW3852	TW728 ^S TW628 ^T				
	TW3856 <i>(4/2017 - Present)</i>	Upper:TW1124.35 ^S Lower:TW730 ^S Lower:TW830 ^T				
	TW3856 <i>(1992 - 8/2017)</i>	Upper:TW1124 ^S Lower:TW730 ^S Lower:TW830 ^T				
	TW3856E	TW630 ^T TW730 ^S				
	TW38510	TW632 ^T TW832 ^S				
	TW3862	TW734 ^T TW834 ^S				

400 Series Tilt-Wash PG Upgrade Windows (2003 to Present)

DP Upgrade Windows

Sash Balancers

BALANCER USAGE CHART 2 - TW UNITS (1992 - Present)

- HP (3.0)
- HP Sun (3.0)
- HP SmartSun (3.0)
- HP Passive Sun (3.0)
- HP Tempered
- HP Sun Tempered
- HP SmartSun Tempered
- HP Passive Sun Tempered
- HP Obscure
- HP Sun Obscure
- HP SmartSun Obscure
- HP Passive Sun Obscure

	Unit No.	Upper and Lower Sash Balancer	Order No.		Unit No.	Upper and Lower Sash Balancer	Order No.
18	TW18210	TW414 ^S	See Charts	20	TW20210	TW514 ^S	See Charts
	TW1832	TW516 ^S			TW2032	TW616 ^S	
	TW1836	TW518 ^S			TW2036	TW618 ^S	
	TW18310 <i>(9/2017 - Present)</i>	TW620.35 ^S			TW20310 <i>(9/2017 - Present)</i>	TW720.35 ^S	
	TW18310 <i>(1992 - 8/2017)</i>	TW620 ^S			TW20310 <i>(1992 - 8/2017)</i>	TW720 ^S	
	TW1842	TW622 ^S			TW2042	TW722 ^S	
	TW1846 <i>(4/2017 - Present)</i>	TW724.35 ^S			TW2046 <i>(4/2017 - Present)</i>	TW824.35 ^S	
	TW1846 <i>(1992 - 3/2017)</i>	TW724 ^S			TW2046 <i>(1992 - 3/2017)</i>	TW824 ^S	
	TW18410	TW626 ^S			TW20410	TW826 ^S	
	TW1852	TW728 ^S			TW2052	TW928 ^S	
	TW1856 <i>(4/2017 - Present)</i>	Upper:TW724.35 ^S Lower:TW930 ^S			TW2056 <i>(4/2017 - Present)</i>	Upper:TW824.35 ^S Lower:TW1130 ^S	
	TW1856 <i>(1992 - 3/2017)</i>	Upper:TW724 ^S Lower: TW930 ^S			TW2056 <i>(1992 - 3/2017)</i>	Upper: TW824 ^S Lower: TW1130 ^S	
	TW1856E	TW830 ^S			TW2056E	TW930 ^S	
	TW18510	TW732 ^S			TW20510	TW1032 ^S	
TW1862	TW934 ^S	TW2062	TW1034 ^S				

Sash Balancers

BALANCER USAGE CHART 2 - TW UNITS (1992 - Present)					
HP (3.0) HP Sun (3.0) HP SmartSun (3.0) HP Passive Sun (3.0) HP Tempered HP Sun Tempered HP SmartSun Tempered HP Passive Sun Tempered HP Obscure HP Sun Obscure HP SmartSun Obscure HP Passive Sun Obscure					
Unit No.	Upper and Lower Sash	Order No.	Unit No.	Upper and Lower Sash	Order No.
	Balancer			Balancer	
24	TW24210	See Charts	26	TW26210	See Charts
	TW2432			TW2632	
	TW2436			TW2636	
	TW24310 <i>(9/2017 - Present)</i>			TW26310 <i>(9/2017 - Present)</i>	
	TW24310 <i>(1992 - 8/2017)</i>			TW26310 <i>(1992 - 8/2017)</i>	
	TW2442			TW2642	
	TW2446 <i>(4/2017 - Present)</i>			TW2646 <i>(4/2017 - Present)</i>	
	TW2446 <i>(1992 - 3/2017)</i>			TW2646 <i>(1992 - 3/2017)</i>	
	TW24410			TW26410	
	TW2452			TW2652	
	TW2456 <i>(4/2017 - Present)</i>			TW2656 <i>(4/2017 - Present)</i>	
	TW2456 <i>(1992 - 3/2017)</i>			TW2656 <i>(1992 - 3/2017)</i>	
	TW2456E			TW2656E	
	TW24510			TW26510	
	TW2462			TW2662	

400 Series Tilt-Wash PG Upgrade Windows (2003 to Present)

DP Upgrade Windows

Sash Balancers

BALANCER USAGE CHART 2 - TW UNITS (1992 - Present)							
HP (3.0) HP Sun (3.0) HP SmartSun (3.0) HP Passive Sun (3.0) HP Tempered HP Sun Tempered HP SmartSun Tempered HP Passive Sun Tempered HP Obscure HP Sun Obscure HP SmartSun Obscure HP Passive Sun Obscure							
	Unit No.	Upper and Lower Sash Balancer	Order No.		Unit No.	Upper and Lower Sash Balancer	Order No.
28	TW2828	TW613 ^S	See Charts	210	TW210210	TW714 ^S	See Charts
	TW28210	TW714 ^S			TW21032	TW816 ^S	
	TW2832	TW816 ^S			TW21036	TW818 ^S	
	TW2836	TW818 ^S			TW210310 (9/2017 - Present)	TW1020.35 ^S	
	TW28310 (9/2017 - Present)	TW920.35 ^S			TW210310 (1992 - 8/2017)	TW1020 ^S	
	TW28310 (1992 - 8/2017)	TW920 ^S			TW21042	TW1022 ^S	
	TW2842	TW1022 ^S			TW21046 (4/2017 - Present)	TW1124.35 ^S	
	TW2846 (4/2017 - Present)	TW1124.35 ^S			TW21046 (1992 - 3/2017)	TW1124 ^S	
	TW2846 (1992 - 3/2017)	TW1024 ^S			TW210410	TW1226 ^S	
	TW28410	TW1126 ^S			TW21052	TW628 ^T TW728 ^S	
	TW2852	TW1228 ^S			TW21056 (4/2017 - Present)	Upper: TW1124.35 ^S Lower: TW730 ^S Lower: 830 ^T	
	TW2856 (4/2017 - Present)	Upper: TW1124.35 ^S Lower: TW830 ^S Lower: TW630 ^T			TW21056 (1992 - 3/2017)	Upper: TW1124 ^S Lower: TW730 ^S Lower: TW830 ^T	
	TW2856 (1992 - 3/2017)	Upper: TW1024 ^S Lower: TW1430 ^S			TW21056E	TW630 ^T TW730 ^S	
	TW2856E	TW1230 ^S			TW210510	TW632 ^T TW832 ^S	
	TW28510	TW1332 ^S			TW21062	TW734 ^T TW834 ^S	
TW2862	TW1434 ^S						

Sash Balancers

BALANCER USAGE CHART 2 - TW UNITS (1992 - Present)					
HP (3.0) HP Sun (3.0) HP SmartSun (3.0) HP Passive Sun (3.0) HP Tempered HP Sun Tempered HP SmartSun Tempered HP Passive Sun Tempered HP Obscure HP Sun Obscure HP SmartSun Obscure HP Passive Sun Obscure					
Unit No.	Upper and Lower Sash	Order No.	Unit No.	Upper and Lower Sash	Order No.
	Balancer			Balancer	
30	TW30210	TW714 ^S	See Charts	TW34210	TW314 ^T TW514
	TW3032	TW816 ^S		TW3432	TW416 ^T TW516 ^S
	TW3036	TW918 ^S		TW3436	TW418 ^T TW618 ^S
	TW30310 (9/2017 - Present)	TW1020.35 ^S		TW34310 (9/2017 - Present)	Upper:TW720.35 ^S Upper:TW420.35 ^T Lower:TW720.35 ^S Lower:TW420.35 ^T
	TW30310 (1992 - 8/2017)	TW1020 ^S		TW34310 (1992 - 8/2017)	TW420 ^T TW720 ^T
	TW3042	TW1122 ^S		TW3442	TW922 ^S
	TW3046 (4/2017 - Present)	Upper:TW724.35 ^S Lower:TW524.35 ^T		TW3446 (4/2017 - Present)	Upper:TW824.35 ^S Lower:TW524.35 ^T
	TW3046 (1992 - 3/2017)	TW724 ^S TW524 ^T		TW3446 (1992 - 3/2017)	TW1024 ^S
	TW30410	TW1226 ^S		TW34410	TW526 ^T TW926 ^S
	TW3052	TW628 ^T TW728 ^S		TW3452	TW628 ^T TW928 ^S
	TW3056 (4/2017 - Present)	Upper:TW724.35 ^S Upper:TW524.35 ^T Lower:TW830 ^S Lower:TW830 ^T		TW3456 (4/2017 - Present)	Upper:TW824.35 ^S Upper:TW524.35 ^T Lower:TW1030 ^S Lower:TW830 ^T
	TW3056 (1992 - 3/2017)	Upper: TW524 ^T Upper: TW724 ^S Lower: TW830 ^T Lower: TW830 ^S		TW3456 (1992 - 3/2017)	Upper: TW524 ^T Upper: TW824 ^S Lower: TW830 ^T Lower: TW1030 ^S
	TW3056E	TW630 ^T TW830 ^S		TW3456E	TW830 ^S TW830 ^T
	TW30510	TW632 ^T TW932 ^S		TW34510	TW632 ^T TW1032 ^S
TW3062	TW734 ^T TW934 ^S	TW3462	TW734 ^T TW1034 ^S		

400 Series Tilt-Wash PG Upgrade Windows (2003 to Present)

DP Upgrade Windows

Sash Balancers

BALANCER USAGE CHART 2 - TW UNITS (1992 - Present)

HP (3.0)
 HP Sun (3.0)
 HP SmartSun (3.0)
 HP Passive Sun (3.0)
 HP Tempered
 HP Sun Tempered
 HP SmartSun Tempered
 HP Passive Sun Tempered
 HP Obscure
 HP Sun Obscure
 HP SmartSun Obscure
 HP Passive Sun Obscure

Unit No.	Upper and Lower Sash	Order No.	Unit No.	Upper and Lower Sash	Order No.
	Balancer			Balancer	
38	TW38210	TW314 ^T TW614 ^S	See Charts		
	TW3832	TW416 ^T TW616 ^S			
	TW3836	TW418 ^T TW718 ^S			
	TW38310 (9/2017 - Present)	Upper:TW820.35 ^S Upper:TW420.35 ^T Lower:TW820.35 ^S Lower:TW420.35 ^T			
	TW38310 (1992 - 8/2017)	TW420 ^T TW820 ^S			
	TW3842	TW522 ^T TW822 ^S			
	TW3846 (4/2017 - Present)	TW1024.35 ^S TW524.35 ^T			
	TW3846 (1992 - 3/2017)	TW524 ^T TW924 ^S			
	TW38410	TW526 ^T TW1026 ^S			
	TW3852	TW628 ^T TW1028 ^S			
	TW3856 (4/2017 - Present)	Upper:TW1024.35 ^S Upper:TW524.35 ^T Lower:TW1230 ^S Lower:TW830 ^T			
	TW3856 (1992 - 3/2017)	Upper: TW524 ^T Upper: TW924 ^S Lower: TW830 ^T Lower: TW1230 ^S			
	TW3856E	TW830 ^T TW930 ^S			
	TW38510	TW632 ^T TW1232 ^S			
	TW3862	TW734 ^T TW1234 ^S			

Sash Balancers

Balancers - Block and Tackle with Shoe

Note:

Order quantity of two when ordering replacements for a unit manufactured prior to November of 2016.

See [Service Guide 0005176](#) for balancer replacement. See [Balancer Replacement Video](#).

Balancer - Block and Tackle with Shoe

Balancer No.	Order No.	Balancer No.	Order No.	Balancer No.	Order No.	Balancer No.	Order No.	Balancer No.	Order No.	Balancer No.	Order No.
TW310	9151976	TW520.35	9169121	TW712	9151928	TW840	9152236	TW1124	9152210	TW1428	9152226
TW312	9151916	TW522	9152197	TW714	9152184	TW842	9152237	TW1124.35	9160191	TW1430	9160270
TW314	9152180	TW524	9152204	TW716	9152188	TW918	9152153	TW1124.5	-	TW1434	9152179
TW316	9152292	TW524.35	9160185	TW718	9152151	TW920	9152195	TW1124.6	9160201	TW1435	9160271
TW318	9160122	TW524.5	-	TW720	9152193	TW920.35	9169126	TW1125	9151946	TW1436	9160275
TW320	9160123	TW524.6	9160195	TW720.35	9169123	TW922	9152201	TW1126	9152160	TW1436.35	9160223
TW320.35	9169125	TW525	9151920	TW722	9152199	TW924	9152208	TW1128	9152216	TW1436.5	9160276
TW322	9160124	TW526	9152154	TW724	9152206	TW924.35	9160189	TW1130	9152167	TW1437	9151955
TW324.35	9160183	TW528	9160146	TW724.35	9160187	TW924.5	-	TW1132	9152174	TW1438	9160275
TW324.5	-	TW530	9160147	TW724.5	-	TW924.6	9160199	TW1134	9152177	TW1440	9152234
TW324.6	9160193	TW532	9160148	TW724.6	9160197	TW925	9151938	TW1136	9152251	TW1442	9152235
TW325	9160129	TW534	9160149	TW725	9151930	TW926	9152158	TW1136.35	9160220	TW1436.5	9160276
TW326	9160130	TW536	9152245	TW726	9152156	TW928	9152214	TW1136.5	9151947	TW1437	9160277
TW410	9151977	TW536.35	9160214	TW728	9152212	TW930	9152165	TW1137	9151948	TW1438	9160278
TW412	9151917	TW536.5	9151921	TW730	9152163	TW932	9152172	TW1138	9160216	TW1532	9160272
TW414	9152181	TW537	9151922	TW732	9152170	TW934	9152220	TW1140	9152228	TW1534	9160273
TW416	9152185	TW538	9160151	TW734	9152218	TW936	9152249	TW1142	9152229	TW1540	9160279
TW418	9152148	TW540	9160152	TW736	9152247	TW936.35	9160218	TW1224	9160265	TW1634	9160274
TW420	9152190	TW542	9160153	TW736.35	9160216	TW936.5	9151939	TW1224.35	9160192		
TW420.35	9169119	TW610	9151979	TW736.5	9151931	TW937	9151940	TW1224.5	-		
TW422	9160131	TW612	9151923	TW737	9151932	TW938	9160198	TW1224.6	9160202		
TW424	9160132	TW614	9152183	TW738	9160190	TW940	9152238	TW1225	9151949		
TW424.35	9160184	TW616	9152187	TW740	9152223	TW942	9152239	TW1226	9152161		
TW424.5	-	TW618	9152150	TW742	9152224	TW1020	9152196	TW1228	9152217		
TW424.6	9160194	TW620	9152192	TW816	9152189	TW1020.35	9169127	TW1230	9152168		
TW425	9152294	TW620.35	9169122	TW818	9152152	TW1022	9152202	TW1232	9152175		
TW426	9160135	TW622	9152198	TW820	9152194	TW1024	9152209	TW1234	9152222		
TW428	9160136	TW624	9152205	TW820.35	9169124	TW1024.35	9160190	TW1236	9152252		
TW430	9160137	TW624.35	9160186	TW822	9152200	TW1024.5	-	TW1236.35	9160221		
TW432	9160138	TW624.5	-	TW824	9152207	TW1024.6	9160200	TW1238	9160222		
TW434	9160139	TW624.6	9160155	TW824.35	9160188	TW1025	9151942	TW1240	9152230		
TW436	9152244	TW625	9151925	TW824.5	-	TW1026	9152159	TW1242	9152231		
TW436.35	9160213	TW626	9152155	TW824.6	9160198	TW1028	9152215	TW1326	9160267		
TW436.5	9152295	TW628	9152211	TW825	9151934	TW1030	9152166	TW1328	9160268		
TW437	9152296	TW630	9152162	TW826	9152157	TW1032	9152173	TW1330	9160269		
TW438	9160141	TW632	9152169	TW828	9152213	TW1034	9152221	TW1332	9152176		
TW440	9160142	TW634	9160156	TW830	9152164	TW1036	9152250	TW1334	9152178		
TW442	9160143	TW636	9152246	TW832	9152171	TW1036.35	9160219	TW1336	9152253		
TW510	9151978	TW636.35	9160215	TW834	9152219	TW1036.5	9151943	TW1336.35	9160222		
TW512	9151918	TW636.5	9151926	TW836	9152248	TW1037	9151944	TW1336.5	9151952		
TW514	9152182	TW637	9151927	TW836.35	9160217	TW1038	9160202	TW1337	9151953		
TW516	9152186	TW640	9160185	TW836.5	9151935	TW1040	9152225	TW1338	9160268		
TW518	9152149	TW642	9160186	TW837	9151936	TW1042	9152227	TW1340	9152232		
TW520	9152191	TW710	9151980	TW838	9160194	TW1122	9152203	TW1342	9152233		

400 Series Tilt-Wash PG Upgrade Windows (2003 to Present)

DP Upgrade Windows

Sash Balancers

Balancers - Block and Tackle with Tab

Note:

See [Service Guide 0005176](#) for balancer replacement. See [Balancer Replacement Video](#).

Balancer - Block and Tackle with Tab

Balancer No.	Order No.	Balancer No.	Order No.	Balancer No.	Order No.	Balancer No.	Order No.	Balancer No.	Order No.
TW310	9151981	TW636.35	9160224	TW842	9051528	TW1136.35	9160226	TW1432	9160113
TW312	9151956	TW632	1625720	TW918	9160107	TW1136.5	9151968	TW1434	1625723
TW314	1625701	TW636	9152254	TW920	9160108	TW1137	9151969	TW1436.35	9160229
TW416	1625703	TW638	9160116	TW924	1625712	TW1138	9160118	TW1436.5	9159448
TW418	1625705	TW636.5	9151960	TW924.35	9160204	TW1128	1625716	TW1437	9151975
TW420	1625707	TW637	9151961	TW924.5	9151964	TW1142	9051517	TW1438	9160121
TW420.35	9169120	TW718	1625706	TW924.6	9160208	TW1225	9160264	TW1532	9160114
TW522	1625709	TW734	1625722	TW942	9051531	TW1228	9160110	TW1632	9160115
TW524	1625711	TW740	9051532	TW1020	9160182	TW1230	1625719		
TW524.35	9160203	TW742	9051524	TW1024	9160109	TW1236.35	9160227		
TW524.5	9151957	TW820	1625708	TW1024.35	9160205	TW1236.5	9159437		
TW524.6	9160207	TW820.35	9169125	TW1024.6	9160209	TW1237	9151971		
TW525	9151958	TW822	1625710	TW1025	9151965	TW1238	9160119		
TW526	1625713	TW830	1625718	TW1026	1625714	TW1328	9160111		
TW610	9151982	TW836	9152255	TW1036.5	9159427	TW1330	9160112		
TW614	1625702	TW836.35	9160225	TW1037	9151967	TW1332	1625721		
TW612	9151959	TW836.5	9151962	TW1040	9051512	TW1336.35	9160228		
TW616	1625704	TW837	9151963	TW1042	9051514	TW1336.5	9159442		
TW628	1625715	TW838	9160117	TW1124.35	9160206	TW1337	9151973		
TW630	1625717	TW840	9051526	TW1124.6	9160210	TW1338	9160120		

Balancer Parts

Shoe - Balancer

Note:

See [Service Guide 0005176](#) for shoe replacement.

		Order No.
		9152082

Spring Clip - Balancer

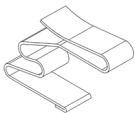
	Order No.
	9045100

Insect Screens

Insect Screens - Full / Even / TruScene®

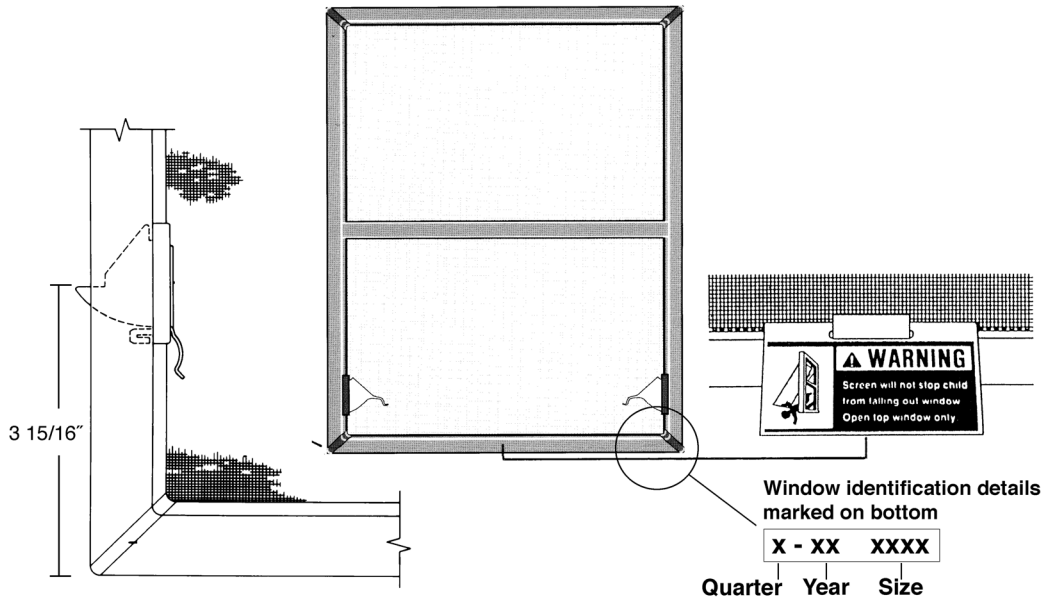

Tilt-Wash (DC) and Tilt-Wash II (TW) Full Insect Screen

Insect Screen - Full / Equal / TruScene®

Unit No.	Dimensions (w x h)	Color Options							
		White	Terra-tone®	Sandtone	Forest Green	Canvas	Dark Bronze	Black	
18	18210	19 7/8 × 34 27/32	1634603	2712203	1103401	0300303	9047903	9073254	9128596
	1832	19 7/8 × 38 27/32	1634604	2712204	1103402	0300304	9047904	9073255	9128597
	1836	19 7/8 × 42 27/32	1634660	2712260	1103550	0300360	9047959	9073310	9128652
	18310	19 7/8 × 46 27/32	1634605	2712205	1103403	0300305	9047905	9073256	9128598
	1842	19 7/8 × 50 27/32	1634606	2712206	1103404	0300306	9047906	9073257	9128599
	1846	19 7/8 × 54 27/32	1634607	2712207	1103405	0300307	9047907	9073258	9128600
	18410	19 7/8 × 58 27/32	1634661	2712261	1103551	0300361	9047960	9073311	9128653
	1852	19 7/8 × 62 27/32	1634608	2712208	1103406	0300308	9047908	9073259	9128601
	1856E	19 7/8 × 66 27/32	1634757	2712361	1103861	0300401	9047998	9073349	9128691
	18510	19 7/8 × 70 27/32	1634662	2712262	1103552	0300362	9047961	9073312	9128654
	1862	19 7/8 × 74 27/32	1634610	2712210	1103408	0300310	9047910	9073261	9128603

400 Series Tilt-Wash PG Upgrade Windows (2003 to Present)

DP Upgrade Windows

Insect Screens

Insect Screen - Full / Equal / TruScene®									
Unit No.	Dimensions (w x h)	White	Terra- tone®	Sandtone	Forest Green	Canvas	Dark Bronze	Black	
20	20210	23 7/8 x 34 27/32	1634611	2712211	1103409	0300311	9047911	9073262	9128604
	2032	23 7/8 x 38 27/32	1634612	2712212	1103410	0300312	9047912	9073263	9128605
	2036	23 7/8 x 42 27/32	1634663	2712263	1103553	0300363	9047962	9073313	9128655
	20310	23 7/8 x 46 27/32	1634613	2712213	1103411	0300313	9047913	9073264	9128606
	2042	23 7/8 x 50 27/32	1634614	2712214	1103412	0300314	9047914	9073265	9128607
	2046	23 7/8 x 54 27/32	1634615	2712215	1103413	0300315	9047915	9073266	9128608
	20410	23 7/8 x 58 27/32	1634664	2712264	1103554	0300364	9047963	9073314	9128656
	2052	23 7/8 x 62 27/32	1634616	2712216	1103414	0300316	9047916	9073267	9128609
	2056E	23 7/8 x 66 27/32	1634760	2712362	1103862	0300402	9047999	9073350	9128692
	20510	23 7/8 x 70 27/32	1634665	2712265	1103555	0300365	9047964	9073315	9128657
	2062	23 7/8 x 74 27/32	1634618	2712218	1103416	0300318	9047918	9073269	9128611
24	24210	27 7/8 x 34 27/32	1634619	2712219	1103417	0300319	9047919	9073270	9128612
	2432	27 7/8 x 38 27/32	1634620	2712220	1103418	0300320	9047920	9073271	9128613
	2436	27 7/8 x 42 27/32	1634666	2712266	1103556	0300366	9047965	9073316	9128658
	24310	27 7/8 x 46 27/32	1634621	2712221	1103419	0300321	9047921	9073272	9128614
	2442	27 7/8 x 50 27/32	1634622	2712222	1103420	0300322	9047922	9073273	9128615
	2446	27 7/8 x 54 27/32	1634623	2712223	1103421	0300323	9047923	9073274	9128616
	24410	27 7/8 x 58 27/32	1634667	2712267	1103557	0300367	9047966	9073317	9128659
	2452	27 7/8 x 62 27/32	1634624	2712224	1103422	0300324	9047924	9073275	9128617
	2456E	27 7/8 x 66 27/32	1634763	2712363	1103863	0300403	9048000	9073351	9128693
	24510	27 7/8 x 70 27/32	1634668	2712268	1103558	0300368	9047967	9073318	9128660
	2462	27 7/8 x 74 27/32	1634626	2712226	1103424	0300326	9047926	9073277	9128619
26	26210	29 7/8 x 34 27/32	1634669	2712269	1103559	0300369	9047968	9073319	9128661
	2632	29 7/8 x 38 27/32	1634670	2712270	1103560	0300370	9047969	9073320	9128662
	2636	29 7/8 x 42 27/32	1634671	2712271	1103561	0300371	9047970	9073321	9128663
	26310	29 7/8 x 46 27/32	1634672	2712272	1103562	0300372	9047971	9073322	9128664
	2642	29 7/8 x 50 27/32	1634673	2712273	1103563	0300373	9047972	9073323	9128665
	2646	29 7/8 x 54 27/32	1634674	2712274	1103564	0300374	9047973	9073324	9128666
	26410	29 7/8 x 58 27/32	1634675	2712275	1103565	0300375	9047974	9073325	9128667
	2652	29 7/8 x 62 27/32	1634676	2712276	1103566	0300376	9047975	9073326	9128668
	2656E	29 7/8 x 66 27/32	1634766	2712364	1103864	0300404	9048001	9073352	9128694
	26510	29 7/8 x 70 27/32	1634678	2712278	1103568	0300378	9047977	9073328	9128670
	2662	29 7/8 x 74 27/32	1634679	2712279	1103569	0300379	9047978	9073329	9128671

Insect Screens

Insect Screen - Full / Equal / TruScene®									
Unit No.	Dimensions (w x h)	White	Terra-tone®	Sandtone	Forest Green	Canvas	Dark Bronze	Black	
28	2828	31 7/8 x 32 27/32	OBD	OBD	OBD	OBD	OBD	OBD	OBD
	28210	31 7/8 x 34 27/32	1634628	2712227	1103425	0300327	9047927	9073278	9128620
	2832	31 7/8 x 38 27/32	1634629	2712228	1103426	0300328	9047928	9073279	9128621
	2836	31 7/8 x 42 27/32	1634680	2712280	1103570	0300380	9047979	9073330	9128672
	28310	31 7/8 x 46 27/32	1634630	2712229	1103427	0300329	9047929	9073280	9128622
	2842	31 7/8 x 50 27/32	1634631	2712230	1103428	0300330	9047930	9073281	9128623
	2846	31 7/8 x 54 27/32	1634632	2712231	1103429	0300331	9047931	9073282	9128624
	28410	31 7/8 x 58 27/32	1634681	2712281	1103571	0300381	9047980	9073331	9128673
	2852	31 7/8 x 62 27/32	1634633	2712232	1103430	0300332	9047932	9073283	9128625
	2856E	31 7/8 x 66 27/32	1634767	2712365	1103865	0300405	9048002	9073353	9128695
	28510	31 7/8 x 70 27/32	1634682	2712282	1103572	0300382	9047981	9073332	9128674
	2862	31 7/8 x 74 27/32	1634635	2712234	1103432	0300334	9047934	9073285	9128627
210	210210	33 7/8 x 34 27/32	1634683	2712283	1103573	0300383	9047982	9073333	9128675
	21032	33 7/8 x 38 27/32	1634684	2712284	1103574	0300384	9047983	9073334	9128676
	21036	33 7/8 x 42 27/32	1634685	2712285	1103575	0300385	9047984	9073335	9128677
	210310	33 7/8 x 46 27/32	1634686	2712286	1103576	0300386	9047985	9073336	9128678
	21042	33 7/8 x 50 27/32	1634687	2712287	1103577	0300387	9047986	9073337	9128679
	21046	33 7/8 x 54 27/32	1634688	2712288	1103578	0300388	9047987	9073338	9128680
	210410	33 7/8 x 58 27/32	1634689	2712289	1103579	0300389	9047988	9073339	9128681
	21052	33 7/8 x 62 27/32	1634690	2712290	1103580	0300390	9047989	9073340	9128682
	21056E	33 7/8 x 66 27/32	1634770	2712366	1103866	0300406	9048003	9073354	9128696
	210510	33 7/8 x 70 27/32	1634692	2712292	1103582	0300392	9047991	9073342	9128684
	21062	33 7/8 x 74 27/32	1634694	2712294	1103584	0300394	9047992	9073343	9128685
	30	30210	35 7/8 x 34 27/32	1634636	2712235	1103433	0300335	9047935	9073286
3032		35 7/8 x 38 27/32	1634637	2712236	1103434	0300336	9047936	9073287	9128629
3036		35 7/8 x 42 27/32	1634695	2712295	1103585	0300395	9047993	9073344	9128686
30310		35 7/8 x 46 27/32	1634638	2712237	1103435	0300337	9047937	9073288	9128630
3042		35 7/8 x 50 27/32	1634639	2712238	1103436	0300338	9047938	9073289	9128631
3046		35 7/8 x 54 27/32	1634640	2712239	1103437	0300339	9047939	9073290	9128632
3048		35 7/8 x 56 27/32	OBD	OBD	OBD	OBD	OBD	OBD	OBD
30410		35 7/8 x 58 27/32	1634696	2712296	1103586	0300396	9047994	9073345	9128687
3052		35 7/8 x 62 27/32	1634641	2712240	1103438	0300340	9047940	9073291	9128633
3056E		35 7/8 x 66 27/32	1634771	2712367	1103867	0300407	9048004	9073355	9128697
30510		35 7/8 x 70 27/32	1634697	2712297	1103587	0300397	9047995	9073346	9128688
3062		35 7/8 x 74 27/32	1634643	2712242	1103440	0300342	9047942	9073293	9128635

400 Series Tilt-Wash PG Upgrade Windows (2003 to Present)

DP Upgrade Windows

Insect Screens

Insect Screen - Full / Equal / TruScene®									
Unit No.	Dimensions (w x h)	White	Terra- tone®	Sandtone	Forest Green	Canvas	Dark Bronze	Black	
34	34210	39 7/8 × 34 27/32	1634644	2712243	1103441	0300343	9047943	9073294	9128636
	3432	39 7/8 × 38 27/32	1634645	2712244	1103442	0300344	9047944	9073295	9128637
	3436	39 7/8 × 42 27/32	1634698	2712298	1103588	0300398	9047996	9073347	9128689
	34310	39 7/8 × 46 27/32	1634646	2712245	1103443	0300345	9047945	9073296	9128638
	3442	39 7/8 × 50 27/32	1634647	2712246	1103444	0300346	9047946	9073297	9128639
	3446	39 7/8 × 54 27/32	1634648	2712247	1103445	0300347	9047947	9073298	9128640
	34410	39 7/8 × 58 27/32	1634699	2712299	1103589	0300399	9047997	9073348	9128690
	3452	39 7/8 × 62 27/32	1634649	2712248	1103446	0300348	9047948	9073299	9128641
	3456E	39 7/8 × 66 27/32	1634774	2712368	1103868	0300408	9048005	9073356	9128698
	34510	39 7/8 × 70 27/32	1611896	2710296	1103590	0300296	9047899	9073250	9128592
	3462	39 7/8 × 74 27/32	1634651	2712250	1103448	0300350	9047950	9073301	9128643
38	38210	43 7/8 × 34 27/32	1634652	2712251	1103449	0300351	9047951	9073302	9128644
	3832	43 7/8 × 38 27/32	1634653	2712252	1103450	0300352	9047952	9073303	9128645
	3836	43 7/8 × 42 27/32	1611897	2710297	1103591	0300297	9047900	9073251	9128593
	38310	43 7/8 × 46 27/32	1634654	2712253	1103451	0300353	9047953	9073304	9128646
	3842	43 7/8 × 50 27/32	1634655	2712254	1103452	0300354	9047954	9073305	9128647
	3846	43 7/8 × 54 27/32	1634656	2712255	1103453	0300355	9047955	9073306	9128648
	38410	43 7/8 × 58 27/32	1611898	2710298	1103592	0300298	9047901	9073252	9128594
	3852	43 7/8 × 62 27/32	1634657	2712256	1103454	0300356	9047956	9073307	9128649
	3856E	43 7/8 × 66 27/32	1634777	2712369	1103869	0300409	9048006	9073357	9128699
	38510	43 7/8 × 70 27/32	1611899	2710299	1103593	0300299	9047902	9073253	9128595
	3862	43 7/8 × 74 27/32	1634659	2712258	1103456	0300358	9047958	9073309	9128651

Insect Screens

Insect Screens - Full / Cottage / TruScene®

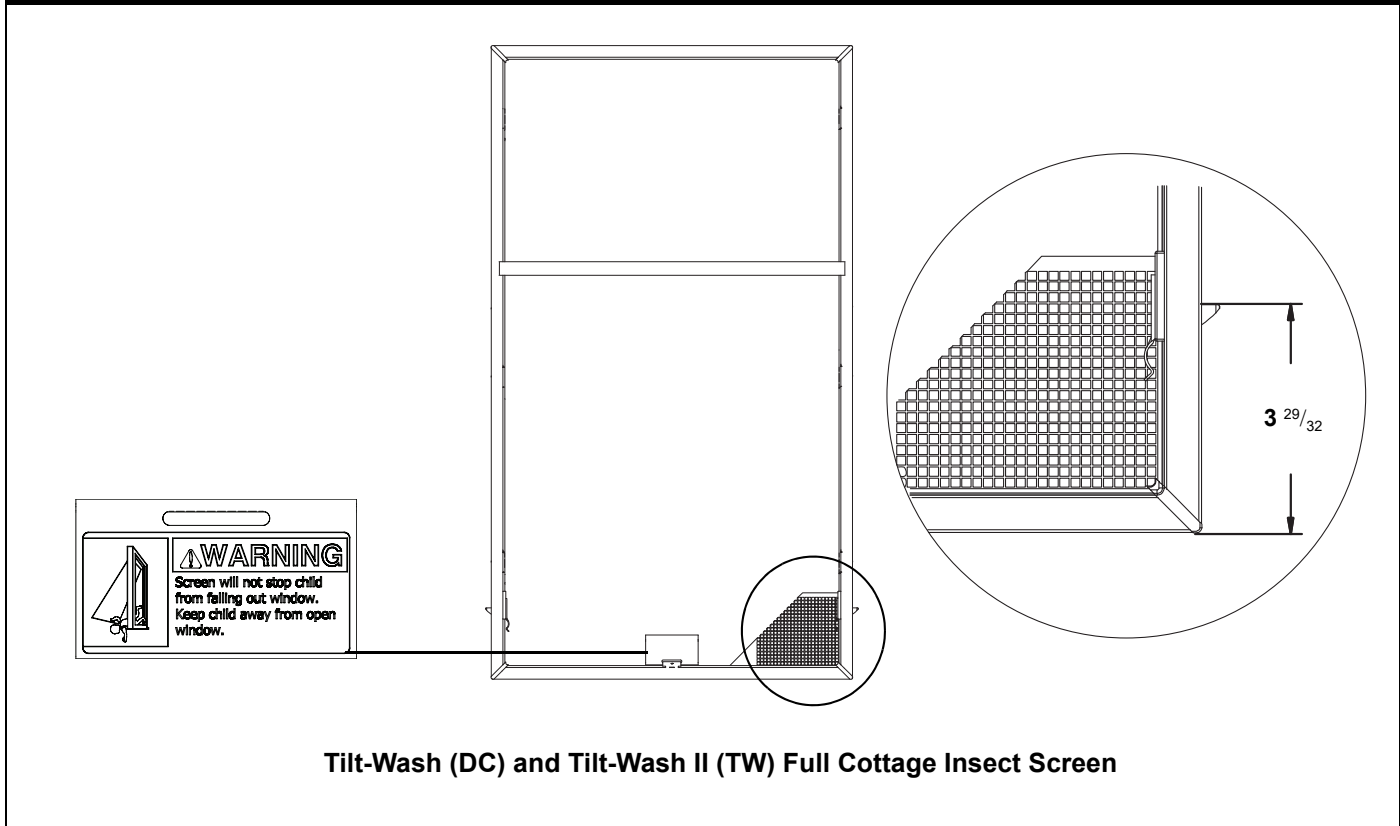

Insect Screen - Full / Cottage / TruScene®									
Unit No.	Dimensions (w x h)	White	Terra-tone®	Sandtone	Forest Green	Canvas	Dark Bronze	Black	
18	18310C	19 7/8 × 46 27/32	1643647	2713147	1141501	0313511	9048141	9073492	9128811
	1842C	19 7/8 × 50 27/32	1643648	2713148	1141502	0313512	9048142	9073493	9128812
	1846C	19 7/8 × 54 27/32	1643649	2713149	1141503	0313513	9048143	9073494	9128813
	18410C	19 7/8 × 58 27/32	1643675	2713175	1141529	0313539	9048169	9073520	9128839
	1852C	19 7/8 × 62 27/32	1643650	2713150	1141504	0313514	9048144	9073495	9128814
	1856C	19 7/8 × 66 27/32	1634609	2712209	1103407	0300309	9047909	9073260	9128602
20	20310C	23 7/8 × 46 27/32	1643651	2713151	1141505	0313515	9048145	9073496	9128815
	2042C	23 7/8 × 50 27/32	1643652	2713152	1141506	0313516	9048146	9073497	9128816
	2046C	23 7/8 × 54 27/32	1643653	2713153	1141507	0313517	9048147	9073498	9128817
	20410C	23 7/8 × 58 27/32	1643676	2713176	1141530	0313540	9048170	9073521	9128840
	2052C	23 7/8 × 62 27/32	1643654	2713154	1141508	0313518	9048148	9073499	9128818
	2056C	23 7/8 × 66 27/32	1634617	2712217	1103415	0300317	9047917	9073268	9128610

400 Series Tilt-Wash PG Upgrade Windows (2003 to Present)

DP Upgrade Windows

Insect Screens

Insect Screen - Full / Cottage / TruScene®									
Unit No.	Dimensions (w x h)	White	Terra-tone®	Sandtone	Forest Green	Canvas	Dark Bronze	Black	
210	210310C	33 7/8 x 46 27/32	1643684	2713184	1141538	0313548	9048178	9073529	9128848
	21042C	33 7/8 x 50 27/32	1643685	2713185	1141539	0313549	9048179	9073530	9128849
	21046C	33 7/8 x 54 27/32	1643686	2713186	1141540	0313550	9048180	9073531	9128850
	210410C	33 7/8 x 58 27/32	1643687	2713187	1141541	0313551	9048181	9073532	9128851
	21052C	33 7/8 x 62 27/32	1643688	2713188	1141542	0313552	9048182	9073533	9128852
	21056C	33 7/8 x 66 27/32	1634691	2712291	1103581	0300391	9047990	9073341	9128683
24	24310C	27 7/8 x 46 27/32	1643655	2713155	1141509	0313519	9048149	9073500	9128819
	2442C	27 7/8 x 50 27/32	1643656	2713156	1141510	0313520	9048150	9073501	9128820
	2446C	27 7/8 x 54 27/32	1643657	2713157	1141511	0313521	9048151	9073502	9128821
	24410C	27 7/8 x 58 27/32	1643677	2713177	1141531	0313541	9048171	9073522	9128841
	2452C	27 7/8 x 62 27/32	1643658	2713158	1141512	0313522	9048152	9073503	9128822
	2456C	27 7/8 x 66 27/32	1634625	2712225	1103423	0300325	9047925	9073276	9128618
26	26310C	29 7/8 x 46 27/32	1643678	2713178	1141532	0313542	9048172	9073523	9128842
	2642C	29 7/8 x 50 27/32	1643679	2713179	1141533	0313543	9048173	9073524	9128843
	2646C	29 7/8 x 54 27/32	1643680	2713180	1141534	0313544	9048174	9073525	9128844
	26410C	29 7/8 x 58 27/32	1643681	2713181	1141535	0313545	9048175	9073526	9128845
	2652C	29 7/8 x 62 27/32	1643682	2713182	1141536	0313546	9048176	9073527	9128846
	2656C	29 7/8 x 66 27/32	1634677	2712277	1103567	0300377	9047976	9073327	9128669
28	28310C	31 7/8 x 46 27/32	1643659	2713159	1141513	0313523	9048153	9073504	9128823
	2842C	31 7/8 x 50 27/32	1643660	2713160	1141514	0313524	9048154	9073505	9128824
	2846C	31 7/8 x 54 27/32	1643661	2713161	1141515	0313525	9048155	9073506	9128825
	28410C	31 7/8 x 58 27/32	1643683	2713183	1141537	0313547	9048177	9073528	9128847
	2852C	31 7/8 x 62 27/32	1643662	2713162	1141516	0313526	9048156	9073507	9128826
	2856C	31 7/8 x 66 27/32	1634634	2712233	1103431	0300333	9047933	9073284	9128626
30	30310C	35 7/8 x 46 27/32	1643663	2713163	1141517	0313527	9048157	9073508	9128827
	3042C	35 7/8 x 50 27/32	1643664	2713164	1141518	0313528	9048158	9073509	9128828
	3046C	35 7/8 x 54 27/32	1643665	2713165	1141519	0313529	9048159	9073510	9128829
	30410C	35 7/8 x 58 27/32	1643689	2713189	1141543	0313553	9048183	9073534	9128853
	3052C	35 7/8 x 62 27/32	1643666	2713166	1141520	0313530	9048160	9073511	9128830
	3056C	35 7/8 x 66 27/32	1634642	2712241	1103439	0300341	9047941	9073292	9128634
34	34310C	39 7/8 x 46 27/32	1643667	2713167	1141521	0313531	9048161	9073512	9128831
	3442C	39 7/8 x 50 27/32	1643668	2713168	1141522	0313532	9048162	9073513	9128832
	3446C	39 7/8 x 54 27/32	1643669	2713169	1141523	0313533	9048163	9073514	9128833
	34410C	39 7/8 x 58 27/32	1643690	2713190	1141544	0313554	9048184	9073535	9128854
	3452C	39 7/8 x 62 27/32	1643670	2713170	1141524	0313534	9048164	9073515	9128834
	3456C	39 7/8 x 66 27/32	1634650	2712249	1103447	0300349	9047949	9073300	9128642

Insect Screens

Insect Screen - Full / Cottage / TruScene®									
Unit No.	Dimensions (w x h)	White	Terra-tone®	Sandtone	Forest Green	Canvas	Dark Bronze	Black	
38	38310C	43 ⁷ / ₈ × 46 ²⁷ / ₃₂	1643671	2713171	1141525	0313535	9048165	9073516	9128835
	3842C	43 ⁷ / ₈ × 50 ²⁷ / ₃₂	1643672	2713172	1141526	0313536	9048166	9073517	9128836
	3846C	43 ⁷ / ₈ × 54 ²⁷ / ₃₂	1643673	2713173	1141527	0313537	9048167	9073518	9128837
	38410C	43 ⁷ / ₈ × 58 ²⁷ / ₃₂	1643646	2713146	1141545	0313510	9048140	9073491	9128810
	3852C	43 ⁷ / ₈ × 62 ²⁷ / ₃₂	1643674	2713174	1141528	0313538	9048168	9073519	9128838
	3856C	43 ⁷ / ₈ × 66 ²⁷ / ₃₂	1634658	2712257	1103455	0300357	9047957	9073308	9128650

Insect Screens - Full / Even / Standard Mesh

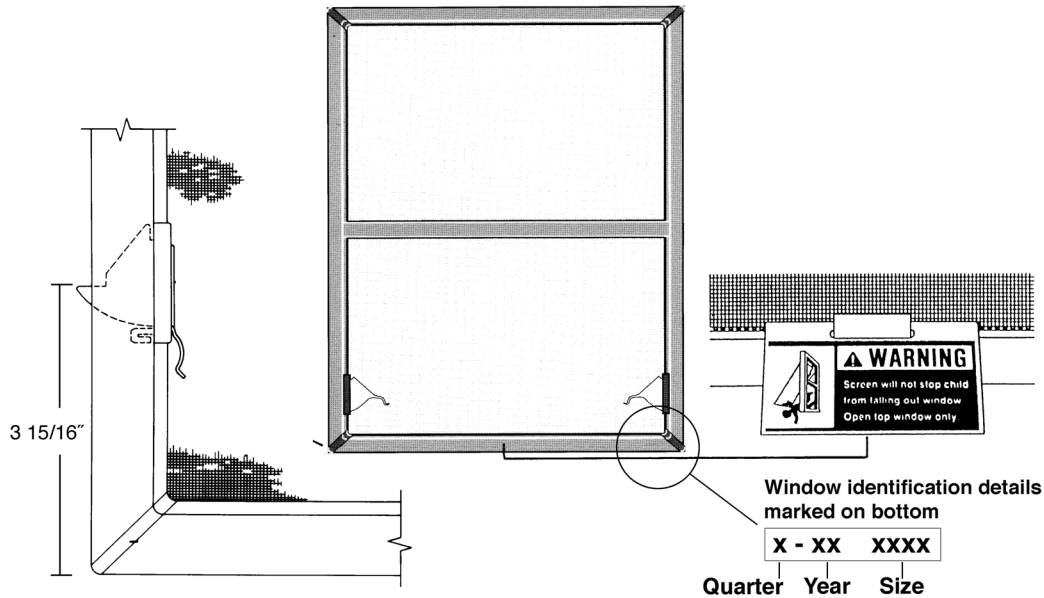

Tilt-Wash (DC) and Tilt-Wash II (TW) Full Insect Screen

Insect Screen - Full / Equal / Standard Mesh

Unit No.	Dimensions (w x h)	White	Terra- tone®	Sandtone	Forest Green	Canvas	Dark Bronze	Black	
		18	18210	19 7/8 x 34 27/32	1610103	2710103	1139701	0313303	9048013
	1832	19 7/8 x 38 27/32	1610104	2710104	1139702	0313304	9048014	9073365	9128707
	1836	19 7/8 x 42 27/32	1610160	2710160	1139850	0313360	9048069	9073420	9128762
	18310	19 7/8 x 46 27/32	1610105	2710105	1139703	0313305	9048015	9073366	9128708
	1842	19 7/8 x 50 27/32	1610106	2710106	1139704	0313306	9048016	9073367	9128709
	1846	19 7/8 x 54 27/32	1610107	2710107	1139705	0313307	9048017	9073368	9128710
	18410	19 7/8 x 58 27/32	1610161	2710161	1139851	0313361	9048070	9073421	9128763
	1852	19 7/8 x 62 27/32	1610108	2710108	1139706	0313308	9048018	9073369	9128711
	1856E	19 7/8 x 66 27/32	1611057	2710461	1149061	0313501	9048131	9073482	9128801
	18510	19 7/8 x 70 27/32	1610162	2710162	1139852	0313362	9048071	9073422	9128764
	1862	19 7/8 x 74 27/32	1610110	2710110	1139708	0313310	9048020	9073371	9128713

Insect Screens

Insect Screen - Full / Equal / Standard Mesh									
Unit No.	Dimensions (w x h)	White	Terra-tone®	Sandtone	Forest Green	Canvas	Dark Bronze	Black	
20	20210	23 7/8 x 34 27/32	1610111	2710111	1139709	0313311	9048021	9073372	9128714
	2032	23 7/8 x 38 27/32	1610112	2710112	1139710	0313312	9048022	9073373	9128715
	2036	23 7/8 x 42 27/32	1610163	2710163	1139853	0313363	9048072	9073423	9128765
	20310	23 7/8 x 46 27/32	1610113	2710113	1139711	0313313	9048023	9073374	9128716
	2042	23 7/8 x 50 27/32	1610114	2710114	1139712	0313314	9048024	9073375	9128717
	2046	23 7/8 x 54 27/32	1610115	2710115	1139713	0313315	9048025	9073376	9128718
	20410	23 7/8 x 58 27/32	1610164	2710164	1139854	0313364	9048073	9073424	9128766
	2052	23 7/8 x 62 27/32	1610116	2710116	1139714	0313316	9048026	9073377	9128719
	2056E	23 7/8 x 66 27/32	1611060	2710462	1149062	0313502	9048132	9073483	9128802
	20510	23 7/8 x 70 27/32	1610165	2710165	1139855	0313365	9048074	9073425	9128767
2062	23 7/8 x 74 27/32	1610118	2710118	1139716	0313198	9048028	9073379	9128721	
24	24210	27 7/8 x 34 27/32	1610119	2710119	1139717	0313319	9048029	9073380	9128722
	2432	27 7/8 x 38 27/32	1610120	2710120	1139718	0313320	9048030	9073381	9128723
	2436	27 7/8 x 42 27/32	1610166	2710166	1139856	0313366	9048075	9073426	9128768
	24310	27 7/8 x 46 27/32	1610121	2710121	1139719	0313321	9048031	9073382	9128724
	2442	27 7/8 x 50 27/32	1610122	2710122	1139720	0313322	9048032	9073383	9128725
	2446	27 7/8 x 54 27/32	1610123	2710123	1139721	0313323	9048033	9073384	9128726
	24410	27 7/8 x 58 27/32	1610167	2710167	1139857	0313367	9048076	9073427	9128769
	2452	27 7/8 x 62 27/32	1610124	2710124	1139722	0313324	9048034	9073385	9128727
	2456E	27 7/8 x 66 27/32	1611063	2710463	1149063	0313503	9048133	9073484	9128803
	24510	27 7/8 x 70 27/32	1610168	2710168	1139858	0313368	9048077	9073428	9128770
2462	27 7/8 x 74 27/32	1610126	2710126	1139724	0313326	9048036	9073387	9128729	
26	26210	29 7/8 x 34 27/32	1610169	2710169	1139859	0313369	9048078	9073429	9128771
	2632	29 7/8 x 38 27/32	1610170	2710170	1139860	0313370	9048079	9073430	9128772
	2636	29 7/8 x 42 27/32	1610171	2710171	1139861	0313371	9048080	9073431	9128773
	26310	29 7/8 x 46 27/32	1610172	2710172	1139862	0313372	9048081	9073432	9128774
	2642	29 7/8 x 50 27/32	1610173	2710173	1139863	0313373	9048082	9073433	9128775
	2646	29 7/8 x 54 27/32	1610174	2710174	1139864	0313374	9048083	9073434	9128776
	26410	29 7/8 x 58 27/32	1610175	2710175	1139865	0313375	9048084	9073435	9128777
	2652	29 7/8 x 62 27/32	1610176	2710176	1139866	0313376	9048085	9073436	9128778
	2656E	29 7/8 x 66 27/32	1611066	2710464	1149064	0313504	9048134	9073485	9128804
	26510	29 7/8 x 70 27/32	1610178	2710178	1139868	0313378	9048087	9073438	9128780
2662	29 7/8 x 74 27/32	1610179	2710179	1139869	0313379	9048088	9073439	9128781	

400 Series Tilt-Wash PG Upgrade Windows (2003 to Present)

DP Upgrade Windows

Insect Screens

Insect Screen - Full / Equal / Standard Mesh									
Unit No.	Dimensions (w x h)	White	Terra- tone®	Sandtone	Forest Green	Canvas	Dark Bronze	Black	
28	2828	31 ⁷ / ₈ × 32 ²⁷ / ₃₂	1610101	2710101	OBD	0313301	9048011	9073362	9128704
	28210	31 ⁷ / ₈ × 34 ²⁷ / ₃₂	1610128	2710127	1139725	0313327	9048037	9073388	9128730
	2832	31 ⁷ / ₈ × 38 ²⁷ / ₃₂	1610129	2710128	1139726	0313328	9048038	9073389	9128731
	2836	31 ⁷ / ₈ × 42 ²⁷ / ₃₂	1610180	2710180	1139870	0313380	9048089	9073440	9128782
	28310	31 ⁷ / ₈ × 46 ²⁷ / ₃₂	1610130	2710129	1139727	0313329	9048039	9073390	9128732
	2842	31 ⁷ / ₈ × 50 ²⁷ / ₃₂	1610131	2710130	1139728	0313330	9048040	9073391	9128733
	2846	31 ⁷ / ₈ × 54 ²⁷ / ₃₂	1610132	2710131	1139729	0313331	9048041	9073392	9128734
	28410	31 ⁷ / ₈ × 58 ²⁷ / ₃₂	1610181	2710181	1139871	0313381	9048090	9073441	9128783
	2852	31 ⁷ / ₈ × 62 ²⁷ / ₃₂	1610133	2710132	1139730	0313332	9048042	9073393	9128735
	2856E	31 ⁷ / ₈ × 66 ²⁷ / ₃₂	1611067	2710465	1149065	0313505	9048135	9073486	9128805
	28510	31 ⁷ / ₈ × 70 ²⁷ / ₃₂	1610182	2710182	1139872	0313382	9048091	9073442	9128784
2862	31 ⁷ / ₈ × 74 ²⁷ / ₃₂	1610135	2710134	1139732	0313334	9048044	9073395	9128737	
210	210210	33 ⁷ / ₈ × 34 ²⁷ / ₃₂	1610183	2710183	1139873	0313383	9048092	9073443	9128785
	21032	33 ⁷ / ₈ × 38 ²⁷ / ₃₂	1610184	2710184	1139874	0313384	9048093	9073444	9128786
	21036	33 ⁷ / ₈ × 42 ²⁷ / ₃₂	1610185	2710185	1139875	0313385	9048094	9073445	9128787
	210310	33 ⁷ / ₈ × 46 ²⁷ / ₃₂	1610186	2710186	1139876	0313386	9048095	9073446	9128788
	21042	33 ⁷ / ₈ × 50 ²⁷ / ₃₂	1610187	2710187	1139877	0313387	9048096	9073447	9128789
	21046	33 ⁷ / ₈ × 54 ²⁷ / ₃₂	1610188	2710188	1139878	0313388	9048097	9073448	9128790
	210410	33 ⁷ / ₈ × 58 ²⁷ / ₃₂	1610189	2710189	1139879	0313389	9048098	9073449	9128791
	21052	33 ⁷ / ₈ × 62 ²⁷ / ₃₂	1610190	2710190	1139880	0313390	9048099	9073450	9128792
	21056E	33 ⁷ / ₈ × 66 ²⁷ / ₃₂	1611070	2710466	1149066	0313506	9048136	9073487	9128806
	210510	33 ⁷ / ₈ × 70 ²⁷ / ₃₂	1610192	2710192	1139882	0313392	9048101	9073452	9128794
21062	33 ⁷ / ₈ × 74 ²⁷ / ₃₂	1610194	2710194	1139884	0313394	9048102	9073453	9128795	
30	30210	35 ⁷ / ₈ × 34 ²⁷ / ₃₂	1610136	2710135	1139733	0313335	9048045	9073396	9128738
	3032	35 ⁷ / ₈ × 38 ²⁷ / ₃₂	1610137	2710136	1139734	0313336	9048046	9073397	9128739
	3036	35 ⁷ / ₈ × 42 ²⁷ / ₃₂	1610195	2710195	1139885	0313395	9048103	9073454	9128796
	30310	35 ⁷ / ₈ × 46 ²⁷ / ₃₂	1610138	2710137	1139735	0313337	9048047	9073398	9128740
	3042	35 ⁷ / ₈ × 50 ²⁷ / ₃₂	1610139	2710138	1139736	0313338	9048048	9073399	9128741
	3046	35 ⁷ / ₈ × 54 ²⁷ / ₃₂	1610140	2710139	1139737	0313339	9048049	9073400	9128742
	3048	35 ⁷ / ₈ × 56 ²⁷ / ₃₂	OBD	2710102	OBD	0313302	9048012	9073363	9128705
	30410	35 ⁷ / ₈ × 58 ²⁷ / ₃₂	1610196	2710196	1139886	0313396	9048104	9073455	9128797
	3052	35 ⁷ / ₈ × 62 ²⁷ / ₃₂	1610141	2710140	1139738	0313340	9048050	9073401	9128743
	3056E	35 ⁷ / ₈ × 66 ²⁷ / ₃₂	1611071	2710467	1149067	0313507	9048137	9073488	9128807
	30510	35 ⁷ / ₈ × 70 ²⁷ / ₃₂	1610197	2710197	1139887	0313397	9048105	9073456	9128798
	3062	35 ⁷ / ₈ × 74 ²⁷ / ₃₂	1610143	2710142	1139740	0313342	9048052	9073403	9128745

Insect Screens

Insect Screen - Full / Equal / Standard Mesh									
Unit No.	Dimensions (w x h)	White	Terra-tone®	Sandtone	Forest Green	Canvas	Dark Bronze	Black	
34	34210	39 7/8 x 34 27/32	1610144	2710143	1139741	0313343	9048053	9073404	9128746
	3432	39 7/8 x 38 27/32	1610145	2710144	1139742	0313344	9048054	9073405	9128747
	3436	39 7/8 x 42 27/32	1610198	2710198	1139888	0313398	9048106	9073457	9128799
	34310	39 7/8 x 46 27/32	1610146	2710145	1139743	0313345	9048055	9073406	9128748
	3442	39 7/8 x 50 27/32	1610147	2710146	1139744	0313346	9048056	9073407	9128749
	3446	39 7/8 x 54 27/32	1610148	2710147	1139745	0313347	9048057	9073408	9128750
	34410	39 7/8 x 58 27/32	1610199	2710199	1139889	0313399	9048107	9073458	9128800
	3452	39 7/8 x 62 27/32	1610149	2710148	1139746	0313348	9048058	9073409	9128751
	3456E	39 7/8 x 66 27/32	1611074	2710468	1149068	0313508	9048138	9073489	9128808
	34510	39 7/8 x 70 27/32	1610096	2710096	1139890	0313296	9048007	9073358	9128700
3462	39 7/8 x 74 27/32	1610151	2710150	1139748	0313350	9048060	9073411	9128753	
38	38210	43 7/8 x 34 27/32	1610152	2710151	1139749	0313351	9048061	9073412	9128754
	3832	43 7/8 x 38 27/32	1610153	2710152	1139750	0313352	9048062	9073413	9128755
	3836	43 7/8 x 42 27/32	1610097	2710097	1139891	0313297	9048008	9073359	9128701
	38310	43 7/8 x 46 27/32	1610154	2710153	1139751	0313353	9048063	9073414	9128756
	3842	43 7/8 x 50 27/32	1610155	2710154	1139752	0313354	9048064	9073415	9128757
	3846	43 7/8 x 54 27/32	1610156	2710155	1139753	0313355	9048065	9073416	9128758
	38410	43 7/8 x 58 27/32	1610098	2710098	1139892	0313298	9048009	9073360	9128702
	3852	43 7/8 x 62 27/32	1610157	2710156	1139754	0313356	9048066	9073417	9128759
	3856E	43 7/8 x 66 27/32	1611077	2710469	1149069	0313509	9048139	9073490	9128809
	38510	43 7/8 x 70 27/32	1610099	2710099	1139893	0313299	9048010	9073361	9128703
3862	43 7/8 x 74 27/32	1610159	2710158	1139756	0313358	9048068	9073419	9128761	

400 Series Tilt-Wash PG Upgrade Windows (2003 to Present)

DP Upgrade Windows

Insect Screens

Insect Screens - Full / Cottage / Standard Mesh

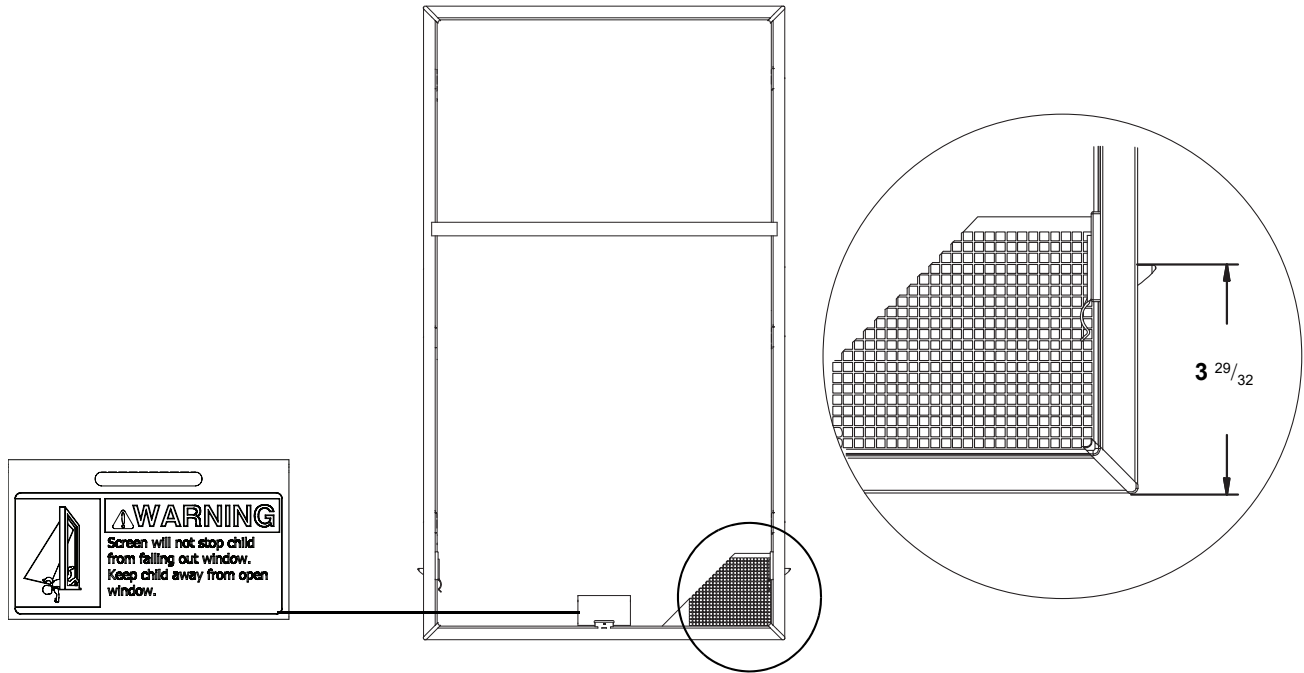

Tilt-Wash (DC) and Tilt-Wash II (TW) Full Cottage Insect Screen

Insect Screen - Full / Cottage / Standard Mesh

Unit No.	Dimensions (w x h)	White	Terra-tone®	Sandtone	Forest Green	Canvas	Dark Bronze	Black	
18	18310C	19 ⁷ / ₈ × 46 ²⁷ / ₃₂	1643602	2713102	1141546	0313556	9048186	9073537	9128856
	1842C	19 ⁷ / ₈ × 50 ²⁷ / ₃₂	1643603	2713103	1141547	0313557	9048187	9073538	9128857
	1846C	19 ⁷ / ₈ × 54 ²⁷ / ₃₂	1643604	2713104	1141548	0313558	9048188	9073539	9128858
	18410C	19 ⁷ / ₈ × 58 ²⁷ / ₃₂	1643630	2713130	1141574	0313584	9048214	9073565	9128884
	1852C	19 ⁷ / ₈ × 62 ²⁷ / ₃₂	1643605	2713105	1141549	0313559	9048189	9073540	9128859
	1856C	19 ⁷ / ₈ × 66 ²⁷ / ₃₂	1610109	2710109	1139707	0313309	9048019	9073370	9128712
20	20310C	23 ⁷ / ₈ × 46 ²⁷ / ₃₂	1643606	2713106	1141550	0313560	9048190	9073541	9128860
	2042C	23 ⁷ / ₈ × 50 ²⁷ / ₃₂	1643607	2713107	1141551	0313561	9048191	9073542	9128861
	2046C	23 ⁷ / ₈ × 54 ²⁷ / ₃₂	1643608	2713108	1141552	0313562	9048192	9073543	9128862
	20410C	23 ⁷ / ₈ × 58 ²⁷ / ₃₂	1643631	2713131	1141575	0313585	9048215	9073566	9128885
	2052C	23 ⁷ / ₈ × 62 ²⁷ / ₃₂	1643609	2713109	1141553	0313563	9048193	9073544	9128863
	2056C	23 ⁷ / ₈ × 66 ²⁷ / ₃₂	1610117	2710117	1139715	0313317	9048027	9073378	9128720

Insect Screens

Insect Screen - Full / Cottage / Standard Mesh									
Unit No.	Dimensions (w x h)	White	Terra-tone®	Sandtone	Forest Green	Canvas	Dark Bronze	Black	
24	24310C	27 7/8 x 46 27/32	1643610	2713110	1141554	0313564	9048194	9073545	9128864
	2442C	27 7/8 x 50 27/32	1643611	2713111	1141555	0313565	9048195	9073546	9128865
	2446C	27 7/8 x 54 27/32	1643612	2713112	1141556	0313566	9048196	9073547	9128866
	24410C	27 7/8 x 58 27/32	1643632	2713132	1141576	0313586	9048216	9073567	9128886
	2452C	27 7/8 x 62 27/32	1643613	2713113	1141557	0313567	9048197	9073548	9128867
	2456C	27 7/8 x 66 27/32	1610125	2710125	1139723	0313325	9048035	9073386	9128728
26	26310C	29 7/8 x 46 27/32	1643633	2713133	1141577	0313587	9048217	9073568	9128887
	2642C	29 7/8 x 50 27/32	1643634	2713134	1141578	0313588	9048218	9073569	9128888
	2646C	29 7/8 x 54 27/32	1643635	2713135	1141579	0313589	9048219	9073570	9128889
	26410C	29 7/8 x 58 27/32	1643636	2713136	1141580	0313590	9048220	9073571	9128890
	2652C	29 7/8 x 62 27/32	1643637	2713137	1141581	0313591	9048221	9073572	9128891
	2656C	29 7/8 x 66 27/32	1610177	2710177	1139867	0313377	9048086	9073437	9128779
28	28310C	31 7/8 x 46 27/32	1643614	2713114	1141558	0313568	9048198	9073549	9128868
	2842C	31 7/8 x 50 27/32	1643615	2713115	1141559	0313569	9048199	9073550	9128869
	2846C	31 7/8 x 54 27/32	1643616	2713116	1141560	0313570	9048200	9073551	9128870
	28410C	31 7/8 x 58 27/32	1643638	2713138	1141582	0313592	9048222	9073573	9128892
	2852C	31 7/8 x 62 27/32	1643617	2713117	1141561	0313571	9048201	9073552	9128871
	2856C	31 7/8 x 66 27/32	1610134	2710133	1139731	0313333	9048043	9073394	9128736
210	210310C	33 7/8 x 46 27/32	1643639	2713139	1141583	0313593	9048223	9073574	9128893
	21042C	33 7/8 x 50 27/32	1643640	2713140	1141584	0313594	9048224	9073575	9128894
	21046C	33 7/8 x 54 27/32	1643641	2713141	1141585	0313595	9048225	9073576	9128895
	210410C	33 7/8 x 58 27/32	1643642	2713142	1141586	0313596	9048226	9073577	9128896
	21052C	33 7/8 x 62 27/32	1643643	2713143	1141587	0313597	9048227	9073578	9128897
	21056C	33 7/8 x 66 27/32	1610191	2710191	1139881	0313391	9048100	9073451	9128793
30	30310C	35 7/8 x 46 27/32	1643618	2713118	1141562	0313572	9048202	9073553	9128872
	3042C	35 7/8 x 50 27/32	1643619	2713119	1141563	0313573	9048203	9073554	9128873
	3046C	35 7/8 x 54 27/32	1643620	2713120	1141564	0313574	9048204	9073555	9128874
	30410C	35 7/8 x 58 27/32	1643644	2713144	1141588	0313598	9048228	9073579	9128898
	3052C	35 7/8 x 62 27/32	1643621	2713121	1141565	0313575	9048205	9073556	9128875
	3056C	35 7/8 x 66 27/32	1610142	2710141	1139739	0313341	9048051	9073402	9128744
34	34310C	39 7/8 x 46 27/32	1643622	2713122	1141566	0313576	9048206	9073557	9128876
	3442C	39 7/8 x 50 27/32	1643623	2713123	1141567	0313577	9048207	9073558	9128877
	3446C	39 7/8 x 54 27/32	1643624	2713124	1141568	0313578	9048208	9073559	9128878
	34410C	39 7/8 x 58 27/32	1643645	2713145	1141589	0313599	9048229	9073580	9128899
	3452C	39 7/8 x 62 27/32	1643625	2713125	1141569	0313579	9048209	9073560	9128879
	3456C	39 7/8 x 66 27/32	1610150	2710149	1139747	0313349	9048059	9073410	9128752

400 Series Tilt-Wash PG Upgrade Windows (2003 to Present)

DP Upgrade Windows

Insect Screens

Insect Screen - Full / Cottage / Standard Mesh									
Unit No.	Dimensions (w x h)	White	Terra- tone®	Sandtone	Forest Green	Canvas	Dark Bronze	Black	
38	38310C	43 ⁷ / ₈ × 46 ²⁷ / ₃₂	1643626	2713126	1141570	0313580	9048210	9073561	9128880
	3842C	43 ⁷ / ₈ × 50 ²⁷ / ₃₂	1643627	2713127	1141571	0313581	9048211	9073562	9128881
	3846C	43 ⁷ / ₈ × 54 ²⁷ / ₃₂	1643628	2713128	1141572	0313582	9048212	9073563	9128882
	38410C	43 ⁷ / ₈ × 58 ²⁷ / ₃₂	1643601	2713101	1141590	0313555	9048185	9073536	9128855
	3852C	43 ⁷ / ₈ × 62 ²⁷ / ₃₂	1643629	2713129	1141573	0313583	9048213	9073564	9128883
	3856C	43 ⁷ / ₈ × 66 ²⁷ / ₃₂	1610158	2710157	1139755	0313357	9048067	9073418	9128760

Insect Screens

Insect Screens - Half / Even & Cottage / TruScene® (4/2007 - Present)

Note:

Half Insect Screens not for use on 400 Tilt-Wash Double-Hung Stormwatch® units. See [Accessory Guide 0005475](#) for complete screen assembly detail. See [Replacement Video](#). Can be used on units made prior to 2007.

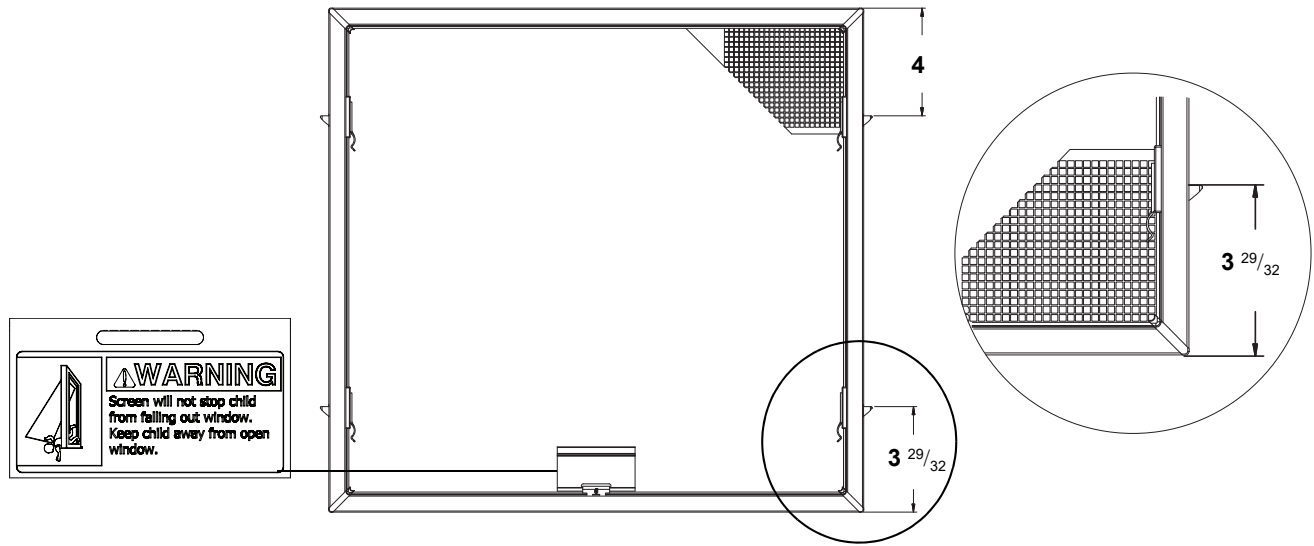

Tilt-Wash (DC) and Tilt-Wash II (TW) Half Insect Screen

400 Series Tilt-Wash PG Upgrade Windows (2003 to Present)

DP Upgrade Windows

Insect Screens

Insect Screen - Half / TruScene® (4/2007 - Present)

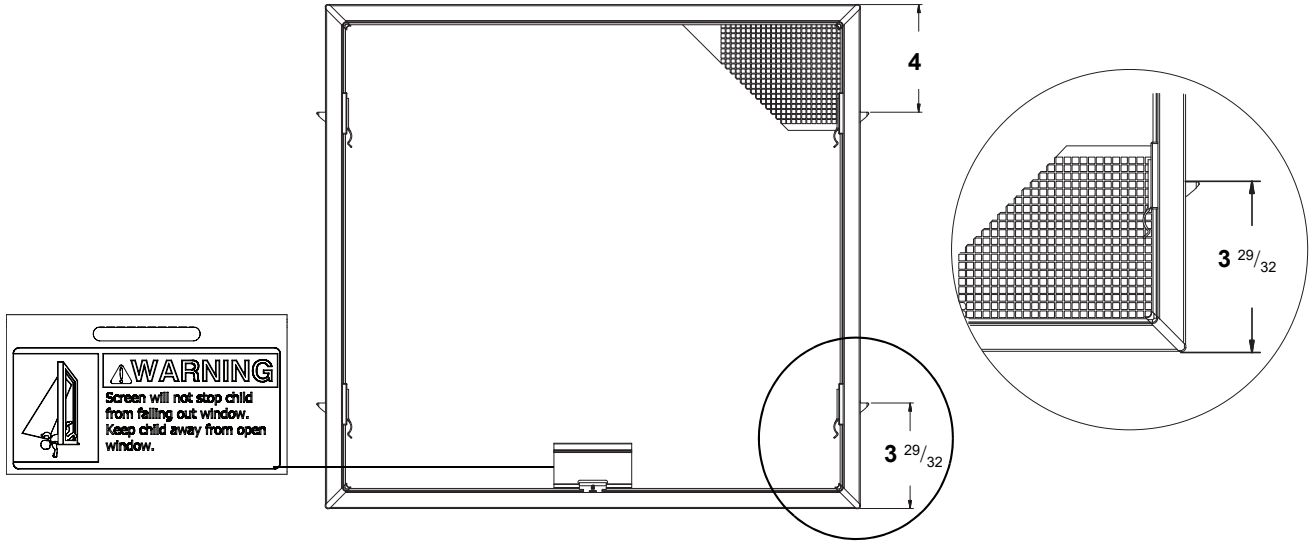

Tilt-Wash (DC) and Tilt-Wash II (TW) Half Insect Screen

Unit No.	Dimensions (w x h)	White	Terra-tone®	Sand-tone	Forest Green	Canvas	Dark Bronze	Black
		18210E/1836RC/1832RC	19 7/8 x 18 7/8	1693336	2791236	1191236	0381336	9048427
1832E/18310RC	19 7/8 x 20 7/8	1693335	2791235	1191235	0381335	9048426	9073777	9129114
1836E/1832C/1842RC	19 7/8 x 22 7/8	1693334	2791234	1191234	0381334	9048425	9073776	9129113
18310E (9/2017 - Present)	19 7/8 x 24 3/8	9168635	9168653	9168617	9168583	9168545	9168612	9168565
18310E (2007 - 8/2017)	19 7/8 x 24 7/8	1693333	2791233	1191233	0381333	9048424	9073775	9129112
1842E/1836C/1852RC	19 7/8 x 26 7/8	1693332	2791232	1191232	0381332	9048423	9073774	9129111
1846E/1856RC (4/2017 - Present)	19 7/8 x 28 3/8	9153066	9153065	9153064	9164090	9164108	9164126	9164144
1846E/18310C/1856RC (2007 - 3/2017)	19 7/8 x 28 7/8	1693331	2791231	1191231	0381331	9048422	9073773	9129110
18410E/1842C	19 7/8 x 30 7/8	1693330	2791230	1191230	0381330	9048421	9073772	9129109
1852E/1846C/18510RC	19 7/8 x 32 7/8	1693329	2791229	1191229	0381329	9048420	9073771	9129108
1856E	19 7/8 x 34 7/8	1693328	2791228	1191228	0381328	9048419	9073770	9129107
18510E/18410C/1862RC	19 7/8 x 36 7/8	1693327	2791227	1191227	0381327	9048418	9073769	9129106
1862E/1852C	19 7/8 x 38 7/8	1693326	2791226	1191226	0381326	9048417	9073768	9129105
1856C (4/2017 - Present)	19 7/8 x 40 3/8	9153076	9153075	9153074	9164099	9164117	9164135	9164153
1862C/18510C/1856C (2007 - 3/2017)	19 7/8 x 40 7/8	1693345	2791245	1191245	0381345	9048436	9073787	9129124

18

Insect Screens

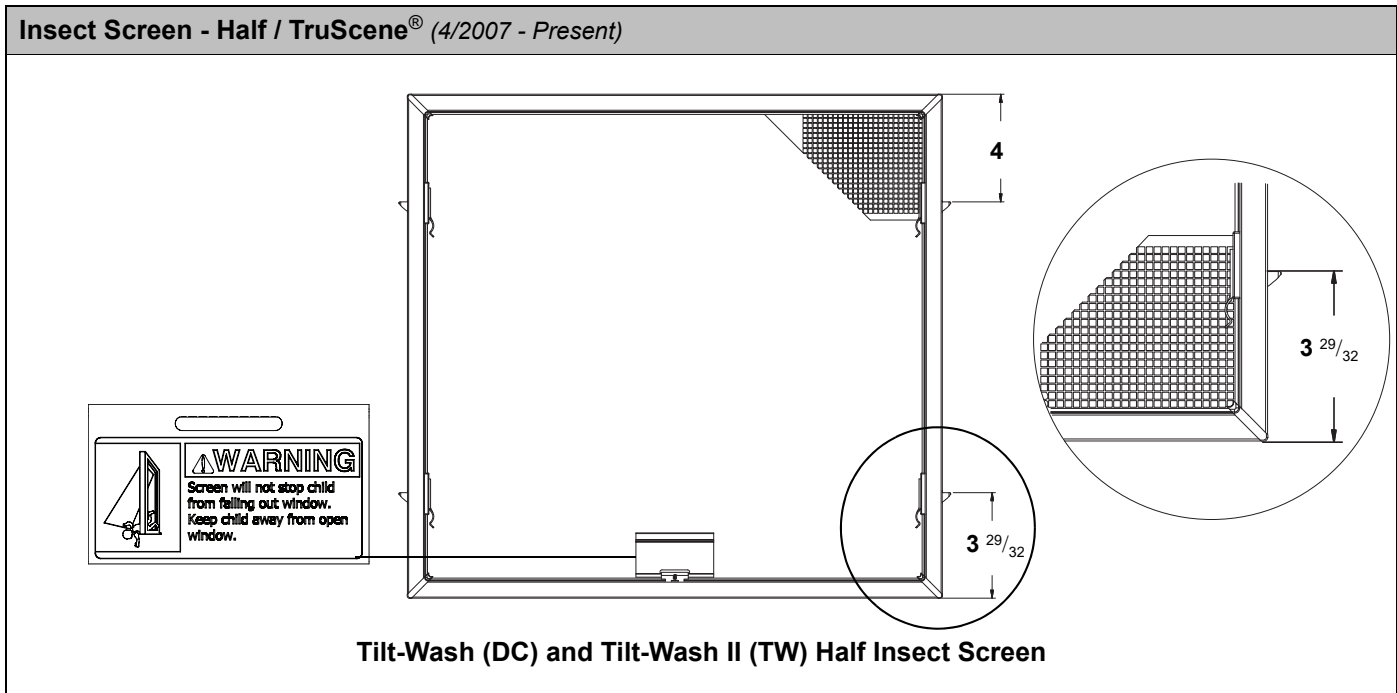

Unit No.	Dimensions (w x h)	White	Terra-tone®	Sand-tone	Forest Green	Canvas	Dark Bronze	Black
20210E/2036RC/2032RC	23 7/8 x 18 7/8	1693323	2791223	1191223	0381323	9048416	9073767	9129104
2032E/20310RC	23 7/8 x 20 7/8	1693322	2791222	1191222	0381322	9048415	9073766	9129103
2036E/2032C/2042RC	23 7/8 x 22 7/8	1693321	2791221	1191221	0381321	9048414	9073765	9129102
20310E <i>(9/2017 - Present)</i>	23 7/8 x 24 3/8	9168634	9168652	9168616	9168582	9168544	9168611	9168564
20310E <i>(2007 - 8/2017)</i>	23 7/8 x 24 7/8	1693320	2791220	1191220	0381320	9048413	9073764	9129101
2042E/2036C/2052RC	23 7/8 x 26 7/8	1693319	2791219	1191219	0381319	9048412	9073763	9129100
2046E/2056RC <i>(4/2017 - Present)</i>	23 7/8 x 28 3/8	9153086	9153085	9153084	9164089	9164107	9164125	9164143
2046E/20310C/2056RC <i>(2007 - 3/2017)</i>	23 7/8 x 28 7/8	1693318	2791218	1191218	0381318	9048411	9073762	9129099
20410E/2042C	23 7/8 x 30 7/8	1693317	2791217	1191217	0381317	9048410	9073761	9129098
2052E/2046C/20510RC	23 7/8 x 32 7/8	1693316	2791216	1191216	0381316	9048409	9073760	9129097
2056E	23 7/8 x 34 7/8	1693315	2791215	1191215	0381315	9048408	9073759	9129096
20510E/20410C/2062RC	23 7/8 x 36 7/8	1693314	2791214	1191214	0381314	9048407	9073758	9129095
2062E/2052C	23 7/8 x 38 7/8	1693313	2791213	1191213	0381313	9048406	9073757	9129094
2056C <i>(4/2017 - Present)</i>	23 7/8 x 40 3/8	9153096	9153095	9153094	9164098	9164116	9164134	9164152
2062C/20510C/2056C <i>(2007 - 3/2017)</i>	23 7/8 x 40 7/8	1693344	2791244	1191244	0381344	9048435	9073786	9129123

400 Series Tilt-Wash PG Upgrade Windows (2003 to Present)

DP Upgrade Windows

Insect Screens

Insect Screen - Half / TruScene® (4/2007 - Present)

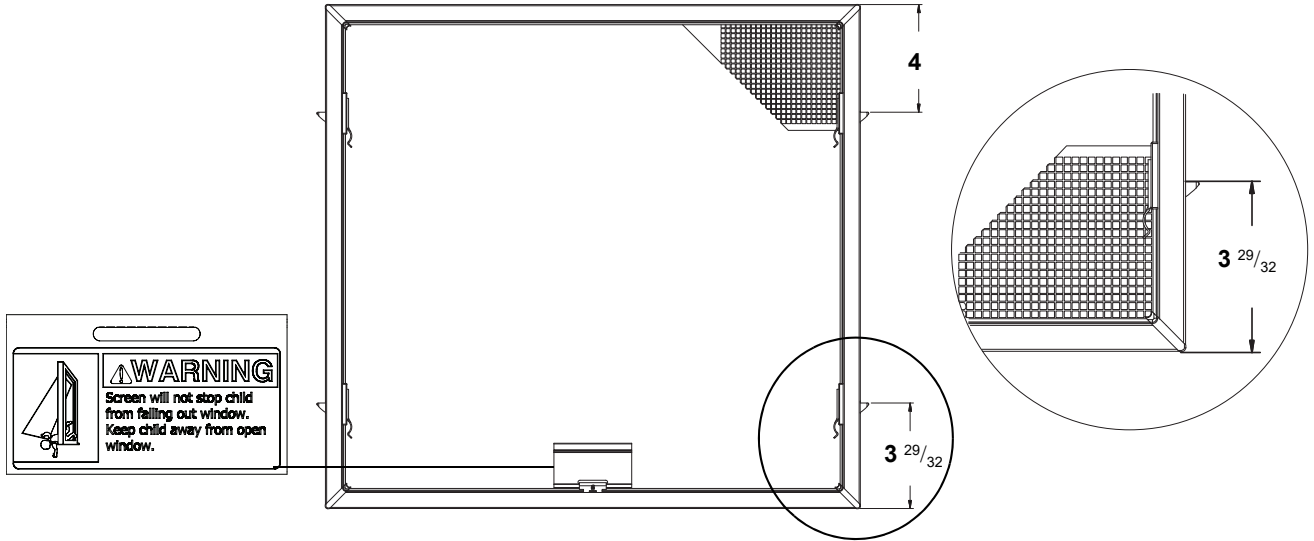

Tilt-Wash (DC) and Tilt-Wash II (TW) Half Insect Screen

Unit No.	Dimensions (w x h)	White	Terra-tone®	Sand-tone	Forest Green	Canvas	Dark Bronze	Black
		24210E/2436RC/2432RC	27 7/8 x 18 7/8	1693310	2791210	1191210	0381310	9048405
2432E/24310RC	27 7/8 x 20 7/8	1693309	2791209	1191209	0381309	9048404	9073755	9129092
2436E/2432C/2442RC	27 7/8 x 22 7/8	1693308	2791208	1191208	0381308	9048403	9073754	9129091
24310E (9/2017 - Present)	27 7/8 x 24 3/8	9168633	9168651	9168615	9168581	9168543	9168610	9168563
24310E (2007 - 8/2017)	27 7/8 x 24 7/8	1693307	2791207	1191207	0381307	9048402	9073753	9129090
2442E/2436C/2452RC	27 7/8 x 26 7/8	1693306	2791206	1191206	0381306	9048401	9073752	9129089
2446E/2456RC (4/2017 - Present)	27 7/8 x 28 3/8	9153126	9153125	9153124	9164088	9164106	9164124	9164142
2446E/24310C/2456RC (2007 - 3/2017)	27 7/8 x 28 7/8	1693305	2791205	1191205	0381305	9048400	9073751	9129088
24410E/2442C	27 7/8 x 30 7/8	1693304	2791204	1191204	0381304	9048399	9073750	9129087
2452E/2446C/24510RC	27 7/8 x 32 7/8	1693303	2791203	1191203	0381303	9048398	9073749	9129086
2456E	27 7/8 x 34 7/8	1693302	2791202	1191202	0381302	9048397	9073748	9129085
24510E/24410C/2462RC	27 7/8 x 36 7/8	1693301	2791201	1191201	0381301	9048396	9073747	9129084
2462E/2452C	27 7/8 x 38 7/8	1693299	2791199	1191199	0381299	9048395	9073746	9129083
2456C (4/2017 - Present)	27 7/8 x 40 3/8	9153136	9153135	9153134	9164097	9164115	9164133	9164151
2462C/24510C/2456C (2007 - 3/2017)	27 7/8 x 40 7/8	1693343	2791243	1191243	0381343	9048434	9073785	9129122

24

Insect Screens

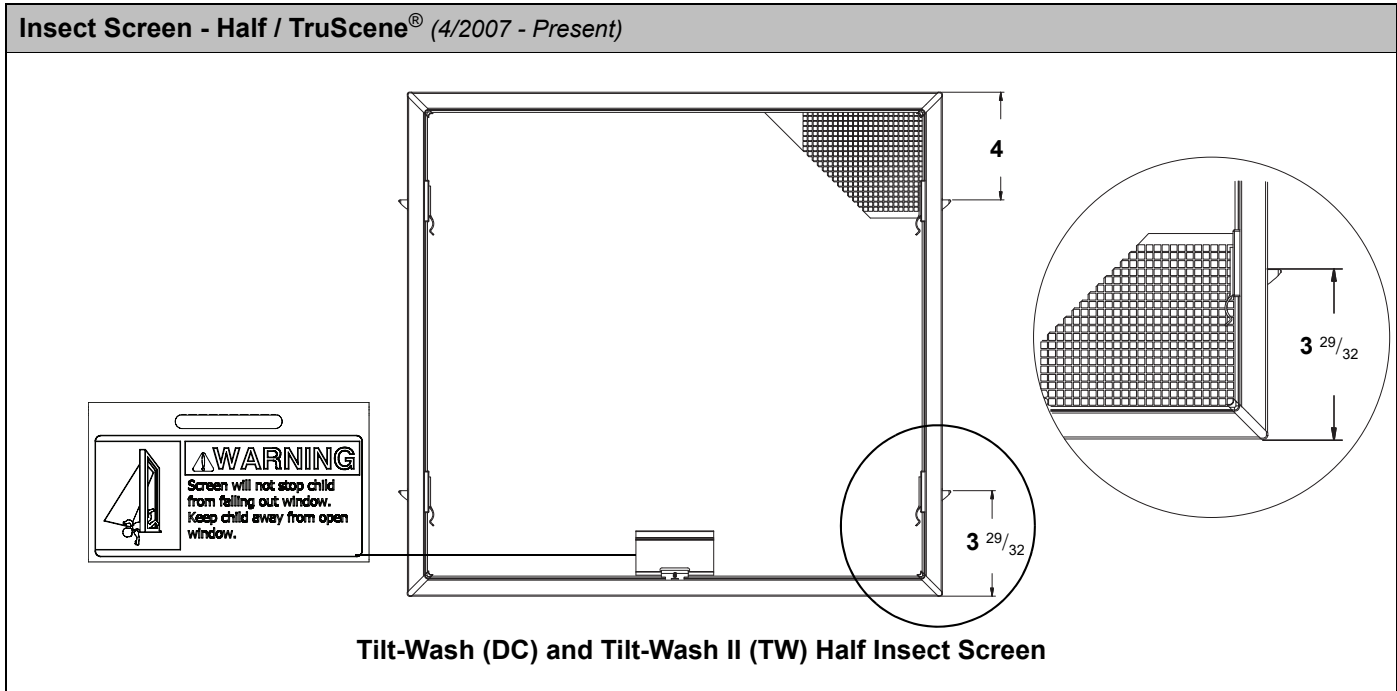

Unit No.	Dimensions (w x h)	White	Terra-tone®	Sand-tone	Forest Green	Canvas	Dark Bronze	Black
26210E/2636RC/2632RC	29 7/8 x 18 7/8	1693296	2791196	1191196	0381296	9048394	9073745	9129082
2632E/26310RC	29 7/8 x 20 7/8	1693295	2791195	1191195	0381295	9048393	9073744	9129081
2636E/2632C/2642RC	29 7/8 x 22 7/8	1693294	2791194	1191194	0381294	9048392	9073743	9129080
26310E <i>(9/2017 - Present)</i>	29 7/8 x 24 3/8	9168632	9168650	9168614	9168580	9168542	9168609	9168562
26310E <i>(2007 - 8/2017)</i>	29 7/8 x 24 7/8	1693293	2791193	1191193	0381293	9048391	9073742	9129079
2642E/2636C/2652RC	29 7/8 x 26 7/8	1693292	2791192	1191192	0381292	9048390	9073741	9129078
2646E/2656RC <i>(4/2017 - Present)</i>	29 7/8 x 28 3/8	9153146	9153145	9153144	9164087	9164105	9164123	9164141
2646E/26310C/2656RC <i>(2007 - 3/2017)</i>	29 7/8 x 28 7/8	1693291	2791191	1191191	0381291	9048389	9073740	9129077
26410E/2642C	29 7/8 x 30 7/8	1693290	2791190	1191190	0381290	9048388	9073739	9129076
2652E/2646C/26510RC	29 7/8 x 32 7/8	1693289	2791189	1191189	0381289	9048387	9073738	9129075
2656E	29 7/8 x 34 7/8	1693288	2791188	1191188	0381288	9048386	9073737	9129074
26510E/26410C/2662RC	29 7/8 x 36 7/8	1693287	2791187	1191187	0381287	9048385	9073736	9129073
2662E/2652C	29 7/8 x 38 7/8	1693286	2791186	1191186	0381286	9048384	9073735	9129072
2656C <i>(4/2017 - Present)</i>	29 7/8 x 40 3/8	9153156	9153155	9153154	9164096	9164114	9164132	9164150
2662C/26510C/2656C <i>(2007 - 3/2017)</i>	29 7/8 x 40 7/8	1693342	2791242	1191242	0381342	9048433	9073784	9129121

400 Series Tilt-Wash PG Upgrade Windows (2003 to Present)

DP Upgrade Windows

Insect Screens

Insect Screen - Half / TruScene® (4/2007 - Present)

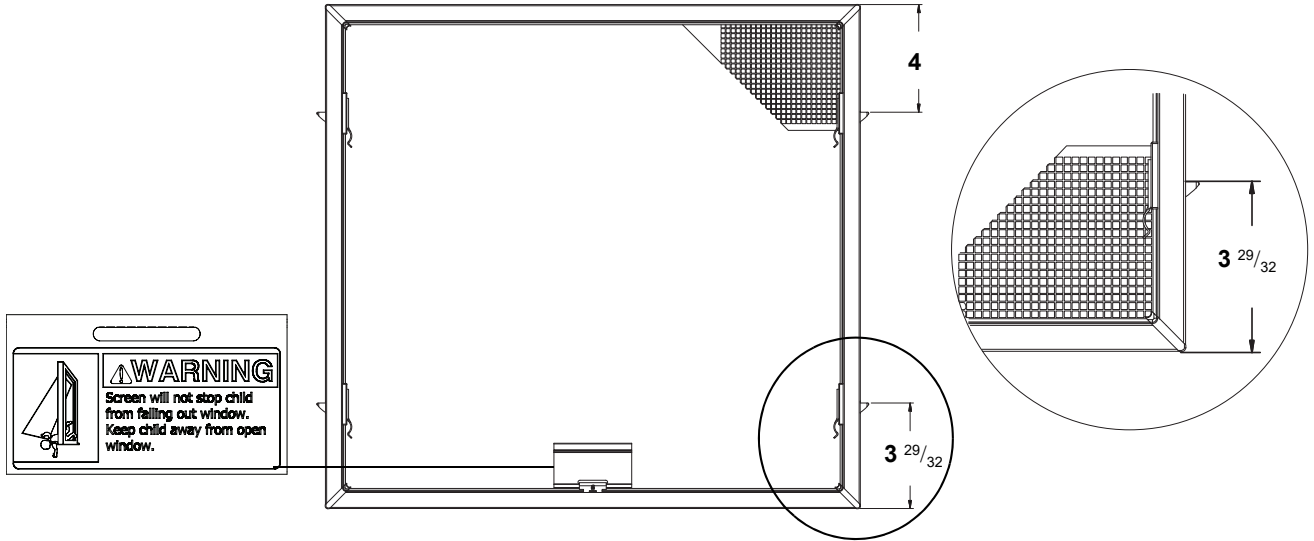

Tilt-Wash (DC) and Tilt-Wash II (TW) Half Insect Screen

Unit No.	Dimensions (w x h)	White	Terra-tone®	Sand-tone	Forest Green	Canvas	Dark Bronze	Black	
28	28210E/2836RC/2832RC	31 7/8 x 18 7/8	1693283	2791183	1191183	0381283	9048383	9073734	9129071
	2832E/28310RC	31 7/8 x 20 7/8	1693282	2791182	1191182	0381282	9048382	9073733	9129070
	2836E/2832C/2842RC	31 7/8 x 22 7/8	1693281	2791181	1191181	0381281	9048381	9073732	9129069
	28310E (9/2017 - Present)	31 7/8 x 24 3/8	9168631	9168649	9168613	9168579	9168541	9168608	9168561
	28310E (2007 - 8/2017)	31 7/8 x 24 7/8	1693280	2791180	1191180	0381280	9048380	9073731	9129068
	2842E/2836C/2852RC	31 7/8 x 26 7/8	1693279	2791179	1191179	0381279	9048379	9073730	9129067
	2846E/2856RC (4/2017 - Present)	31 7/8 x 28 3/8	9153166	9153165	9153164	9164086	9164104	9164122	9164140
	2846E/28310C/2856RC (2007 - 3/2017)	31 7/8 x 28 7/8	1693278	2791178	1191178	0381278	9048378	9073729	9129066
	28410E/2842C	31 7/8 x 30 7/8	1693277	2791177	1191177	0381277	9048377	9073728	9129065
	2852E/2846C/28510RC	31 7/8 x 32 7/8	1693276	2791176	1191176	0381276	9048376	9073727	9129064
	2856E	31 7/8 x 34 7/8	1693275	2791175	1191175	0381275	9048375	9073726	9129063
	28510E/28410C/2862RC	31 7/8 x 36 7/8	1693274	2791174	1191174	0381274	9048374	9073725	9129062
	2862E/2852C	31 7/8 x 38 7/8	1693273	2791173	1191173	0381273	9048373	9073724	9129061
	2856C (4/2017 - Present)	31 7/8 x 40 3/8	9153176	9153175	9153174	9164095	9164113	9164131	9164149
2862C/28510C/2856C (2007 - 3/2017)	31 7/8 x 40 7/8	1693341	2791241	1191241	0381341	9048432	9073783	9129120	

Insect Screens

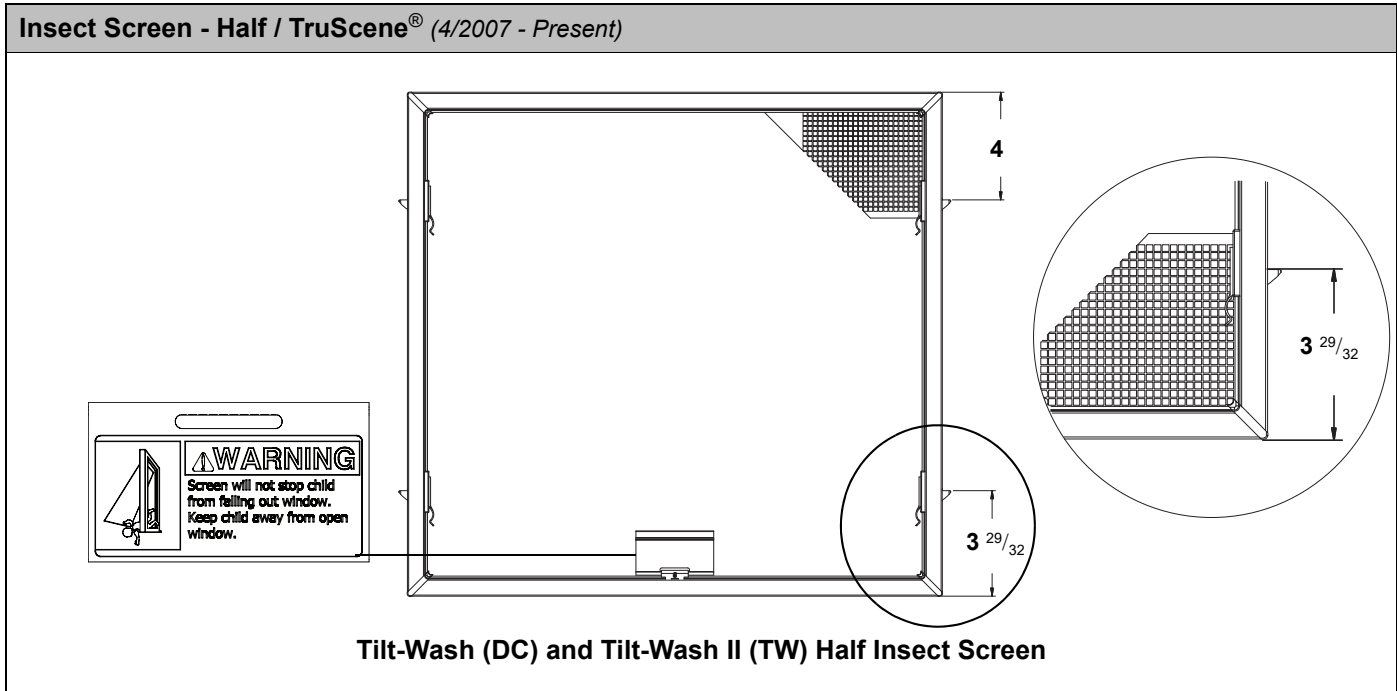

Unit No.	Dimensions (w x h)	White	Terra-tone®	Sand-tone	Forest Green	Canvas	Dark Bronze	Black
210210E/21036RC/21032RC	33 7/8 x 18 7/8	1693270	2791170	1191170	0381270	9048372	9073723	9129060
21032E/210310RC	33 7/8 x 20 7/8	1693269	2791169	1191169	0381269	9048371	9073722	9129059
21036E/21032C/21042RC	33 7/8 x 22 7/8	1693268	2791168	1191168	0381268	9048370	9073721	9129058
210310E <i>(9/2017 - Present)</i>	33 7/8 x 24 3/8	9168630	9168648	9168596	9168578	9168540	9168607	9168560
210310E <i>(2007 - 8/2017)</i>	33 7/8 x 24 7/8	1693267	2791167	1191167	0381267	9048369	9073720	9129057
21042E/21036C/21052RC	33 7/8 x 26 7/8	1693266	2791166	1191166	0381266	9048368	9073719	9129056
21046E/21056RC <i>(4/2017 - Present)</i>	33 7/8 x 28 3/8	9153106	9153105	9153104	9164085	9164103	9164121	9164139
21046E/210310C/21056RC <i>(2007 - 3/2017)</i>	33 7/8 x 28 7/8	1693265	2791165	1191165	0381265	9048367	9073718	9129055
210410E/21042C	33 7/8 x 30 7/8	1693264	2791164	1191164	0381264	9048366	9073717	9129054
21052E/21046C/210510RC	33 7/8 x 32 7/8	1693263	2791163	1191163	0381263	9048365	9073716	9129053
21056E	33 7/8 x 34 7/8	1693262	2791162	1191162	0381262	9048364	9073715	9129052
210510E/210410C/21062RC	33 7/8 x 36 7/8	1693261	2791161	1191161	0381261	9048363	9073714	9129051
21062E/21052C	33 7/8 x 38 7/8	1693260	2791160	1191160	0381260	9048362	9073713	9129050
21056C <i>(4/2017 - Present)</i>	33 7/8 x 40 3/8	9153116	9153115	9153114	9164094	9164112	9164130	9164148
21062C/210510C/21056C <i>(2007 - 3/2017)</i>	33 7/8 x 40 7/8	1693340	2791240	1191240	0381340	9048431	9073782	9129119

400 Series Tilt-Wash PG Upgrade Windows (2003 to Present)

DP Upgrade Windows

Insect Screens

Insect Screen - Half / TruScene® (4/2007 - Present)

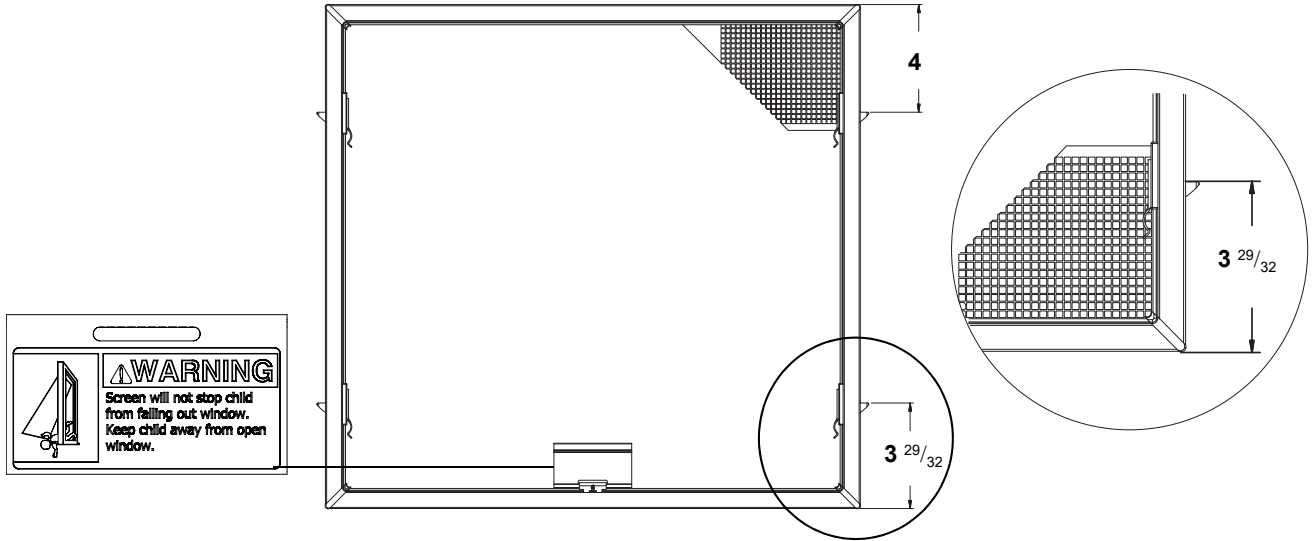

Tilt-Wash (DC) and Tilt-Wash II (TW) Half Insect Screen

Unit No.	Dimensions (w x h)								
		White	Terra-tone®	Sand-tone	Forest Green	Canvas	Dark Bronze	Black	
30210E/3036RC/3032RC	35 7/8 x 18 7/8	1693257	2791157	1191157	0381257	9048361	9073712	9129049	
3032E/30310RC	35 7/8 x 20 7/8	1693256	2791156	1191156	0381256	9048360	9073711	9129048	
3036E/3032C/3042RC	35 7/8 x 22 7/8	1693255	2791155	1191155	0381255	9048359	9073710	9129047	
30310E (9/2017 - Present)	35 7/8 x 24 3/8	9168629	9168647	9168595	9168577	9168539	9168606	9168559	
30310E (2007 - 8/2017)	35 7/8 x 24 7/8	1693254	2791154	1191154	0381254	9048358	9073709	9129046	
3042E/3036C/3052RC	35 7/8 x 26 7/8	1693253	2791153	1191153	0381253	9048357	9073708	9129045	
3046E/3056RC (4/2017 - Present)	35 7/8 x 28 3/8	9153186	9153185	9153184	9164084	9164102	9164120	9164138	
3046E/30310C/3056RC (2007 - 3/2017)	35 7/8 x 28 7/8	1693252	2791152	1191152	0381252	9048356	9073707	9129044	
30410E/3042C	35 7/8 x 30 7/8	1693251	2791151	1191151	0381251	9048355	9073706	9129043	
3052E/3046C/30510RC	35 7/8 x 32 7/8	1693250	2791150	1191150	0381250	9048354	9073705	9129042	
3056E	35 7/8 x 34 7/8	1693249	2791149	1191149	0381249	9048353	9073704	9129041	
30510E/30410C/3062RC	35 7/8 x 36 7/8	1693248	2791148	1191148	0381248	9048352	9073703	9129040	
3062E/3052C	35 7/8 x 38 7/8	1693247	2791147	1191147	0381247	9048351	9073702	9129039	
3056C (4/2017 - Present)	35 7/8 x 40 3/8	9153196	9153195	9153194	9164093	9164111	9164129	9164147	
3062C/30510C/3056C (2007 - 3/2017)	35 7/8 x 40 7/8	1693339	2791239	1191239	0381339	9048430	9073781	9129118	

30

Insect Screens

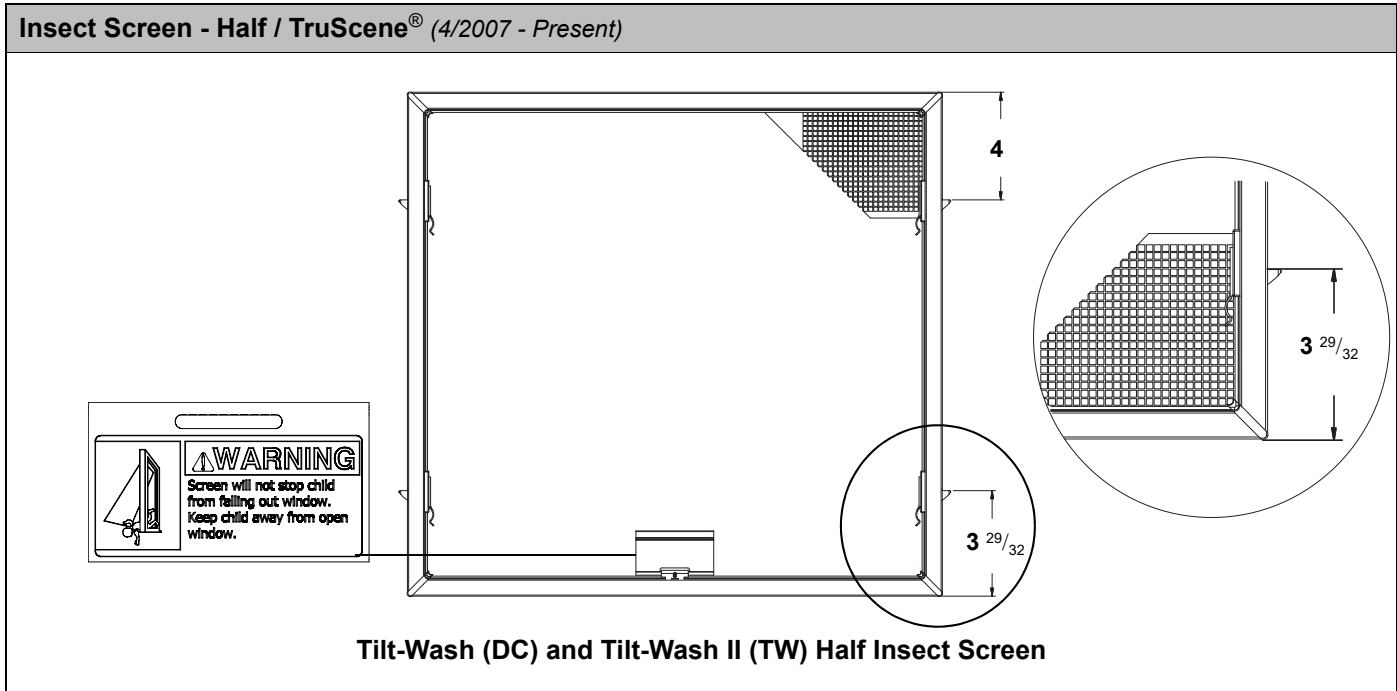

Unit No.	Dimensions (w x h)	White	Terra-tone®	Sand-tone	Forest Green	Canvas	Dark Bronze	Black
34210E/3436RC/3432RC	39 7/8 x 18 7/8	1693244	2791144	1191144	0381244	9048350	9073701	9129038
3432E/34310RC	39 7/8 x 20 7/8	1693243	2791143	1191143	0381243	9048349	9073700	9129037
3436E/3432C/3442RC	39 7/8 x 22 7/8	1693242	2791142	1191142	0381242	9048348	9073699	9129036
34310E <i>(9/2017 - Present)</i>	39 7/8 x 24 3/8	9168628	9168646	9168594	9168576	9168538	9168605	9168558
34310E <i>(2007 - 8/2017)</i>	39 7/8 x 24 7/8	1693241	2791141	1191141	0381241	9048347	9073698	9129035
3442E/3436C/3452RC	39 7/8 x 26 7/8	1693240	2791140	1191140	0381240	9048346	9073697	9129034
3446E/3456RC <i>(4/2017 - Present)</i>	39 7/8 x 28 3/8	9153205	9153204	OBD	9164083	9164101	9164119	9164137
3446E/34310C/3456RC <i>(2007 - 3/2017)</i>	39 7/8 x 28 7/8	1693239	2791139	1191139	0381239	9048345	9073696	9129033
34410E/3442C	39 7/8 x 30 7/8	1693238	2791138	1191138	0381238	9048344	9073695	9129032
3452E/3446C/34510RC	39 7/8 x 32 7/8	1693237	2791137	1191137	0381237	9048343	9073694	9129031
3456E	39 7/8 x 34 7/8	1693236	2791136	1191136	0381236	9048342	9073693	9129030
34510E/34410C/3462RC	39 7/8 x 36 7/8	1693235	2791135	1191135	0381235	9048341	9073692	9129029
3462E/3452C	39 7/8 x 38 7/8	1693234	2791134	1191134	0381234	9048340	9073691	9129028
3456C <i>(4/2017 - Present)</i>	35 7/8 x 40 3/8	9153215	9153214	9153213	9164092	9164110	9164128	9164146
3462C/34510C/3456C <i>(2007 - 3/2017)</i>	39 7/8 x 40 7/8	1693338	2791238	1191238	0381338	9048429	9073780	9129117

400 Series Tilt-Wash PG Upgrade Windows (2003 to Present)

DP Upgrade Windows

Insect Screens

Insect Screen - Half / TruScene® (4/2007 - Present)

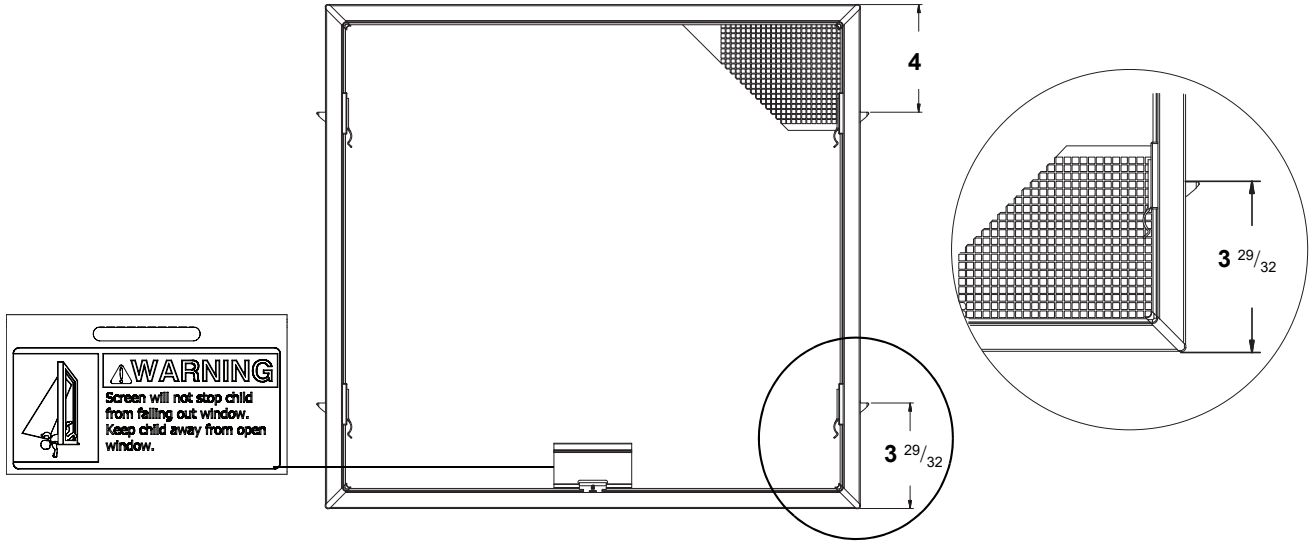

Tilt-Wash (DC) and Tilt-Wash II (TW) Half Insect Screen

Unit No.	Dimensions (w x h)	White	Terra-tone®	Sand-tone	Forest Green	Canvas	Dark Bronze	Black
38210E/3836RC/3832RC	43 7/8 x 18 7/8	1693231	2791131	1191131	0381231	9048339	9073690	9129027
3832E/38310RC	43 7/8 x 20 7/8	1693230	2791130	1191130	0381230	9048338	9073689	9129026
3836E/3832C/3842RC	43 7/8 x 22 7/8	1693229	2791129	1191129	0381229	9048337	9073688	9129025
38310E (9/2017 - Present)	43 7/8 x 24 3/8	9168627	9168645	9168593	9168575	9168537	9168604	9168557
38310E (2007 - 8/2017)	43 7/8 x 24 7/8	1693228	2791128	1191128	0381228	9048336	9073687	9129024
3842E/3836C/3852RC	43 7/8 x 26 7/8	1693227	2791127	1191127	0381227	9048335	9073686	9129023
3846E/3856RC (4/2017 - Present)	43 7/8 x 28 3/8	9153224	9153223	OBD	9164082	9164100	9164118	9164136
3846E/38310C/3856RC (2007 - 3/2017)	43 7/8 x 28 7/8	1693226	2791126	1191126	0381226	9048334	9073685	9129022
38410E/3842C	43 7/8 x 30 7/8	1693225	2791125	1191125	0381225	9048333	9073684	9129021
3852E/3846C/38510RC	43 7/8 x 32 7/8	1693224	2791124	1191124	0381224	9048332	9073683	9129020
3856E	43 7/8 x 34 7/8	1693223	2791123	1191123	0381223	9048331	9073682	9129019
38510E/38410C/3862RC	43 7/8 x 36 7/8	1693222	2791122	1191122	0381222	9048330	9073681	9129018
3862E/3852C	43 7/8 x 38 7/8	1693221	2791121	1191121	0381221	9048329	9073680	9129017
3856C (4/2017 - Present)	43 7/8 x 40 3/8	9153234	9153233	9153232	9164091	9164109	9164127	9164145
3862C/38510C/3856C (2007 - 3/2017)	43 7/8 x 40 7/8	1693337	2791237	1191237	0381337	9048428	9073779	9129116

38

Insect Screens

Insect Screens - Half / Even & Cottage / Standard Mesh (4/2007 - Present)

Note:

Half Insect Screens not for use on 400 Tilt-Wash Double-Hung Stormwatch® units. See [Accessory Guide 0005475](#) for complete screen assembly detail. See [Replacement Video](#). Can be used on units made prior to 2007.

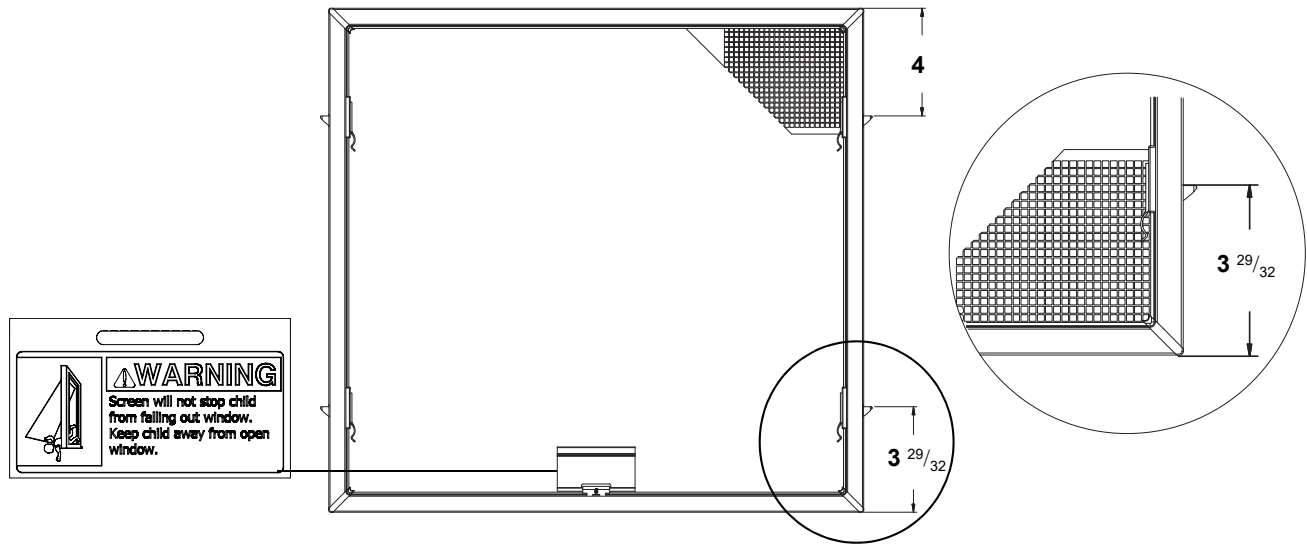

Tilt-Wash (DC) and Tilt-Wash II (TW) Half Insect Screen

400 Series Tilt-Wash PG Upgrade Windows (2003 to Present)

DP Upgrade Windows

Insect Screens

Insect Screen - Half / Standard Mesh (4/2007 - Present)

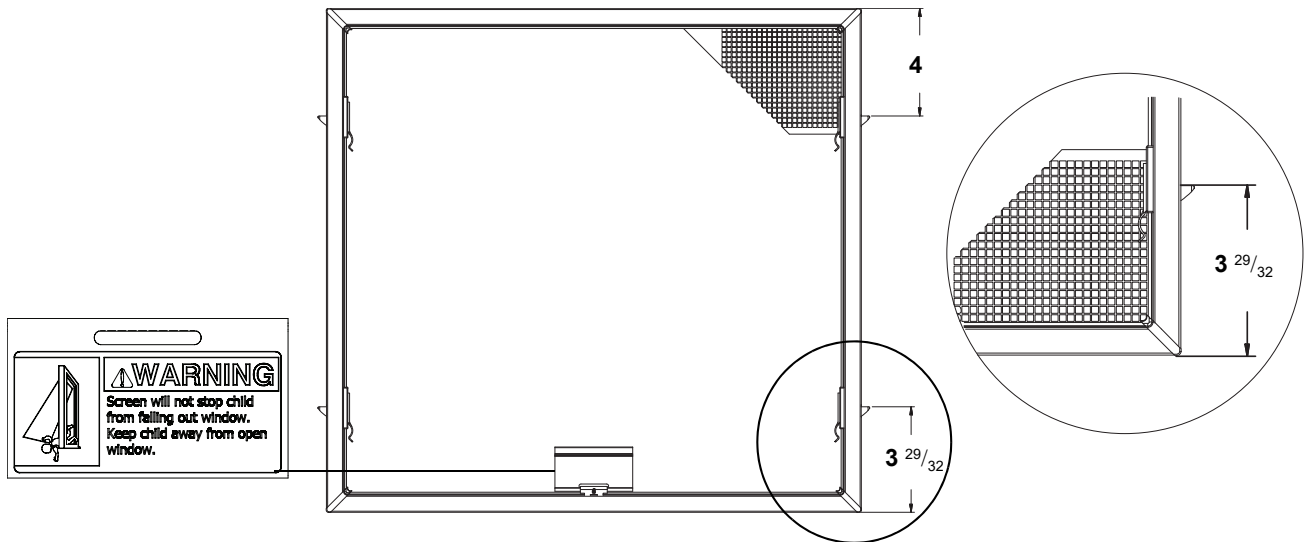

Tilt-Wash (DC) and Tilt-Wash II (TW) Half Insect Screen

Unit No.	Dimensions (w x h)	Color Options							
		White	Terra-tone®	Sand-tone	Forest Green	Canvas	Dark Bronze	Black	
18210E/1836RC/1832RC	19 7/8 x 18 7/8	1693218	2791118	1191118	0381218	9048328	9073679	9129016	
1832E/18310RC	19 7/8 x 20 7/8	1693217	2791117	1191117	0381217	9048327	9073678	9129015	
1836E/1832C/1842RC	19 7/8 x 22 7/8	1693216	2791116	1191116	0381216	9048326	9073677	9129014	
18310E (9/2017 - Present)	19 7/8 x 24 3/8	9168626	9168644	9168592	9168574	9168536	9168603	9168556	
18310E (2007 - 8/2017)	19 7/8 x 24 7/8	1693215	2791115	1191115	0381215	9048325	9073676	9129013	
1842E/1836C/1852RC	19 7/8 x 26 7/8	1693214	2791114	1191114	0381214	9048324	9073675	9129012	
1846E/1856RC (4/2017 - Present)	19 7/8 x 28 3/8	9153063	9153062	9153061	9153060	9153058	9153059	9153057	
1846E/18310C/1856RC (2007 - 3/2017)	19 7/8 x 28 7/8	1693213	2791113	1191113	0381213	9048323	9073674	9129011	
18410E/1842C	19 7/8 x 30 7/8	1693212	2791112	1191112	0381212	9048322	9073673	9129010	
1852E/1846C/18510RC	19 7/8 x 32 7/8	1693211	2791111	1191111	0381211	9048321	9073672	9129009	
1856E	19 7/8 x 34 7/8	1693210	2791110	1191110	0381210	9048320	9073671	9129008	
18510E/18410C/1862RC	19 7/8 x 36 7/8	1693209	2791109	1191109	0381209	9048319	9073670	9129007	
1862E/1852C	19 7/8 x 38 7/8	1693208	2791108	1191108	0381208	9048318	9073669	9129006	
1856C (4/2017 - Present)	19 7/8 x 40 3/8	9153073	9153072	9153071	9153070	9153068	9153069	9153067	
1862C/18510C/1856C (2007 - 3/2017)	19 7/8 x 40 7/8	1693354	2791254	1191254	0381354	9048445	9073796	9129133	

18

Insect Screens

Insect Screen - Half / Standard Mesh (4/2007 - Present)

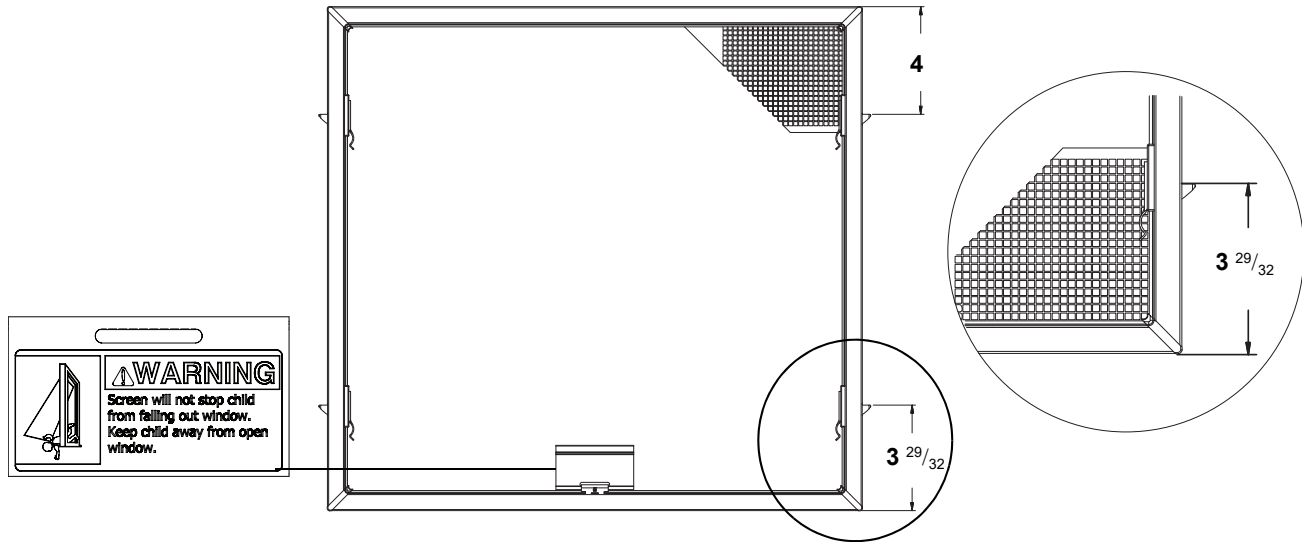

Tilt-Wash (DC) and Tilt-Wash II (TW) Half Insect Screen

Unit No.	Dimensions (w x h)	White	Terra-tone®	Sand-tone	Forest Green	Canvas	Dark Bronze	Black
20210E/2036RC/2032RC	23 7/8 x 18 7/8	1693205	2791105	1191105	0381205	9048317	9073668	9129005
2032E/20310RC	23 7/8 x 20 7/8	1693204	2791104	1191104	0381204	9048316	9073667	9129004
2036E/2032C/2042RC	23 7/8 x 22 7/8	1693203	2791103	1191103	0381203	9048315	9073666	9129003
20310E <i>(9/2017 - Present)</i>	23 7/8 x 24 3/8	9168625	9168643	9168591	9168573	9168535	9168602	9168555
20310E <i>(2007 - 8/2017)</i>	23 7/8 x 24 7/8	1693202	2791102	1191102	0381202	9048314	9073665	9129002
2042E/2036C/2052RC	23 7/8 x 26 7/8	1693201	2791101	1191101	0381201	9048313	9073664	9129001
2046E/2056RC <i>(4/2017 - Present)</i>	23 7/8 x 28 3/8	9153083	9153082	9153081	9153080	9153078	9153079	9153077
2046E/20310C/2056RC <i>(2007 - 3/2017)</i>	23 7/8 x 28 7/8	1693199	2791099	1191099	0381199	9048312	9073663	9129000
20410E/2042C	23 7/8 x 30 7/8	1693198	2791098	1191098	0381198	9048311	9073662	9128999
2052E/2046C/20510RC	23 7/8 x 32 7/8	1693197	2791097	1191097	0381197	9048310	9073661	9128998
2056E	23 7/8 x 34 7/8	1693196	2791096	1191096	0381196	9048309	9073660	9128997
20510E/20410C/2062RC	23 7/8 x 36 7/8	1693195	2791095	1191095	0381195	9048308	9073659	9128996
2062E/2052C	23 7/8 x 38 7/8	1693194	2791094	1191094	0381194	9048307	9073658	9128995
2056C <i>(4/2017 - Present)</i>	23 7/8 x 40 3/8	9153093	9153092	9153091	9153090	9153088	9153089	9153087
2062C/20510C/2056C <i>(2007 - 3/2017)</i>	23 7/8 x 40 7/8	1693353	2791253	1191253	0381353	9048444	9073795	9129132

400 Series Tilt-Wash PG Upgrade Windows (2003 to Present)

DP Upgrade Windows

Insect Screens

Insect Screen - Half / Standard Mesh (4/2007 - Present)

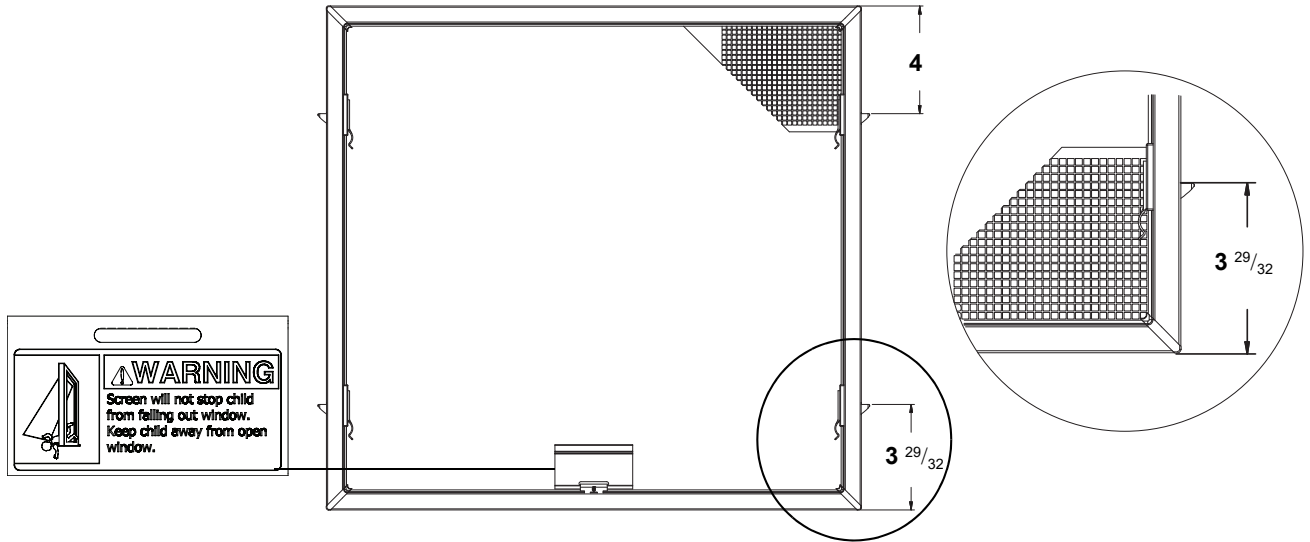

Tilt-Wash (DC) and Tilt-Wash II (TW) Half Insect Screen

Unit No.	Dimensions (w x h)	Color Options						
		White	Terra-tone®	Sand-tone	Forest Green	Canvas	Dark Bronze	Black
24210E/2436RC/2432RC	27 7/8 x 18 7/8	1693191	2791091	1191091	0381191	9048306	9073657	9128994
2432E/24310RC	27 7/8 x 20 7/8	1693190	2791090	1191090	0381190	9048305	9073656	9128993
2436E/2432C/2442RC	27 7/8 x 22 7/8	1693189	2791089	1191089	0381189	9048304	9073655	9128992
24310E (9/2017 - Present)	27 7/8 x 24 3/8	9168624	9168642	9168590	9168572	9168534	9168601	9168554
24310E (2007 - 8/2017)	27 7/8 x 24 7/8	1693188	2791088	1191088	0381188	9048303	9073654	9128991
2442E/2436C/2452RC	27 7/8 x 26 7/8	1693187	2791087	1191087	0381187	9048302	9073653	9128990
2446E/2456RC (4/2017 - Present)	27 7/8 x 28 3/8	9153123	9153122	9153121	9153120	9153118	9153119	9153117
2446E/24310C/2456RC (2007 - 3/2017)	27 7/8 x 28 7/8	1693186	2791086	1191086	0381186	9048301	9073652	9128989
24410E/2442C	27 7/8 x 30 7/8	1693185	2791085	1191085	0381185	9048300	9073651	9128988
2452E/2446C/24510RC	27 7/8 x 32 7/8	1693184	2791084	1191084	0381184	9048299	9073650	9128987
2456E	27 7/8 x 34 7/8	1693183	2791083	1191083	0381183	9048298	9073649	9128986
24510E/24410C/2462RC	27 7/8 x 36 7/8	1693182	2791082	1191082	0381182	9048297	9073648	9128985
2462E/2452C	27 7/8 x 38 7/8	1693181	2791081	1191081	0381181	9048296	9073647	9128984
2456C (4/2017 - Present)	27 7/8 x 40 3/8	9153133	9153132	9153131	9153130	9153128	9153129	9153127
2462C/24510C/2456C (2007 - 3/2017)	27 7/8 x 40 7/8	1693352	2791252	1191252	0381352	9048443	9073794	9129131

24

Insect Screens

Insect Screen - Half / Standard Mesh (4/2007 - Present)

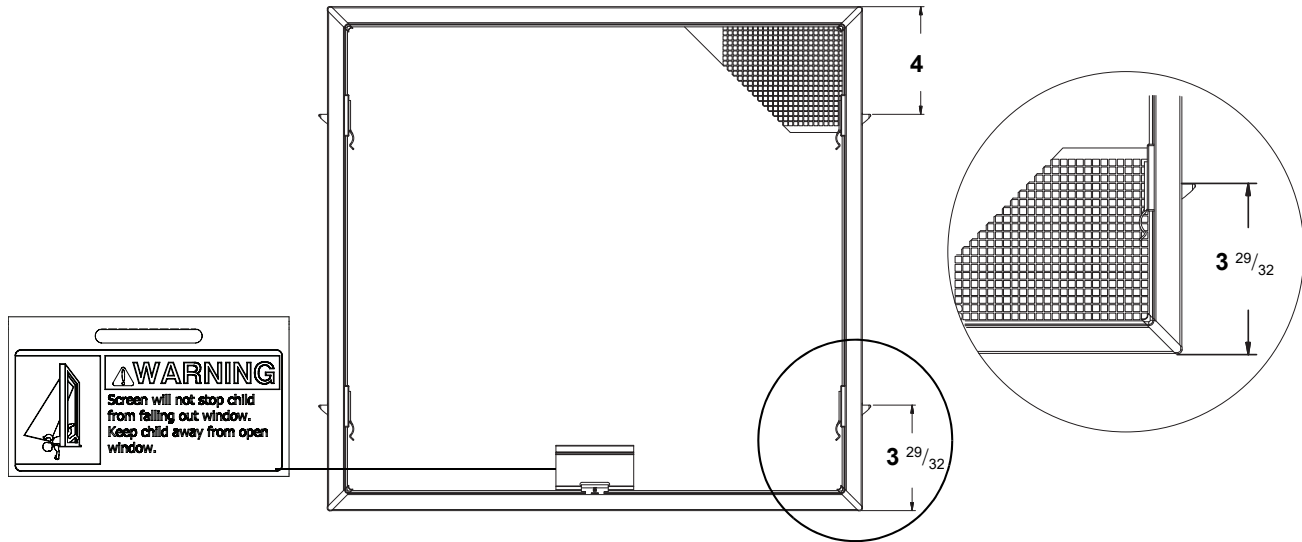

Tilt-Wash (DC) and Tilt-Wash II (TW) Half Insect Screen

Unit No.	Dimensions (w x h)	White	Terra-tone®	Sand-tone	Forest Green	Canvas	Dark Bronze	Black
26210E/2636RC/2632RC	29 7/8 x 18 7/8	1693178	2791078	1191078	0381178	9048295	9073646	9128983
2632E/26310RC	29 7/8 x 20 7/8	1693177	2791077	1191077	0381177	9048294	9073645	9128982
2636E/2632C/2642RC	29 7/8 x 22 7/8	1693176	2791076	1191076	0381176	9048293	9073644	9128981
26310E <i>(9/2017 - Present)</i>	29 7/8 x 24 3/8	9168623	9168641	9168589	9168571	9168533	9168600	9168553
26310E <i>(2007 - 8/2017)</i>	29 7/8 x 24 7/8	1693175	2791075	1191075	0381175	9048292	9073643	9128980
2642E/2636C/2652RC	29 7/8 x 26 7/8	1693174	2791074	1191074	0381174	9048291	9073642	9128979
2646E/2656RC <i>(4/2017 - Present)</i>	29 7/8 x 28 3/8	9153143	9153142	9153141	9153140	9153138	9153139	9153137
26 2646E/26310C/2656RC <i>(2007 - 3/2017)</i>	29 7/8 x 28 7/8	1693173	2791073	1191073	0381173	9048290	9073641	9128978
26410E/2642C	29 7/8 x 30 7/8	1693172	2791072	1191072	0381172	9048289	9073640	9128977
2652E/2646C/26510RC	29 7/8 x 32 7/8	1693171	2791071	1191071	0381171	9048288	9073639	9128976
2656E	29 7/8 x 34 7/8	1693170	2791070	1191070	0381170	9048287	9073638	9128975
26510E/26410C/2662RC	29 7/8 x 36 7/8	1693169	2791069	1191069	0381169	9048286	9073637	9128974
2662E/2652C	29 7/8 x 38 7/8	1693168	2791068	1191068	0381168	9048285	9073636	9128973
2656C <i>(4/2017 - Present)</i>	29 7/8 x 40 3/8	9153153	9153152	9153151	9153150	9153148	9153149	9153147
2662C/26510C/2656C <i>(2007 - 3/2017)</i>	29 7/8 x 40 7/8	1693351	2791251	1191251	0381351	9048442	9073793	9129130

400 Series Tilt-Wash PG Upgrade Windows (2003 to Present)

DP Upgrade Windows

Insect Screens

Insect Screen - Half / Standard Mesh (4/2007 - Present)

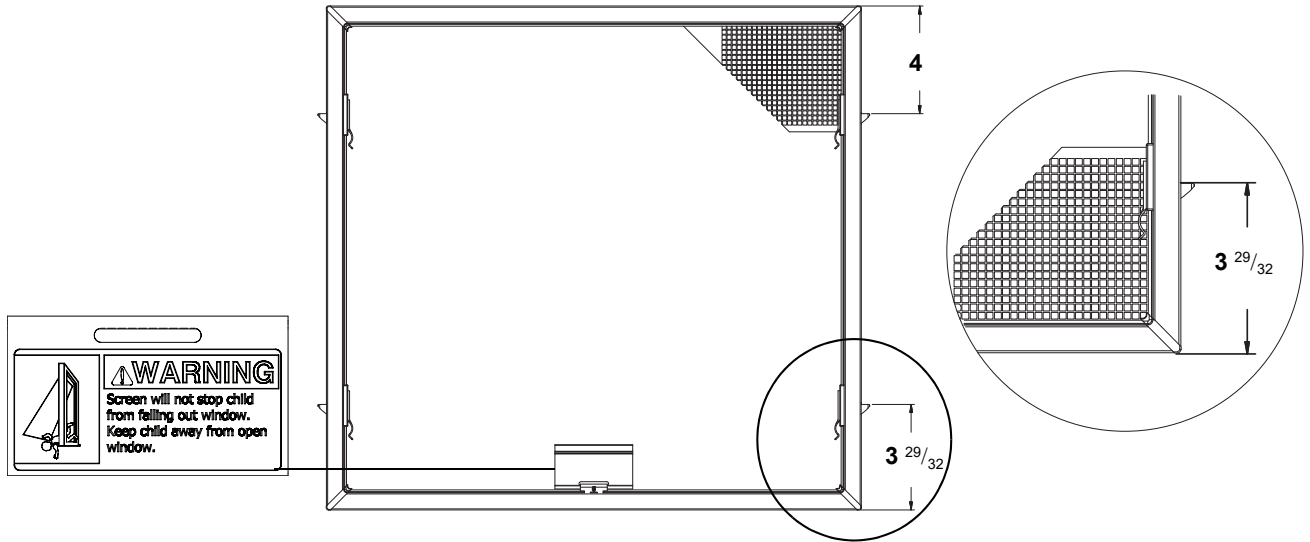

Tilt-Wash (DC) and Tilt-Wash II (TW) Half Insect Screen

Unit No.	Dimensions (w x h)	White	Terra-tone®	Sand-tone	Forest Green	Canvas	Dark Bronze	Black
28210E/2836RC/2832RC	31 7/8 x 18 7/8	1693165	2791065	1191065	0381165	9048284	9073635	9128972
2832E/28310RC	31 7/8 x 20 7/8	1693164	2791064	1191064	0381164	9048283	9073634	9128971
2836E/2832C/2842RC	31 7/8 x 22 7/8	1693163	2791063	1191063	0381163	9048282	9073633	9128970
28310E (9/2017 - Present)	31 7/8 x 24 3/8	9168622	9168640	9168588	9168570	9168532	9168599	9168552
28310E (2007 - 8/2017)	31 7/8 x 24 7/8	1693162	2791062	1191062	0381162	9048281	9073632	9128969
2842E/2836C/2852RC	31 7/8 x 26 7/8	1693161	2791061	1191061	0381161	9048280	9073631	9128968
2846E/2856RC (4/2017 - Present)	31 7/8 x 28 3/8	9153163	9153162	9153161	9153160	9153158	9153159	9153157
2846E/28310C/2856RC (2007 - 3/2017)	31 7/8 x 28 7/8	1693160	2791060	1191060	0381160	9048279	9073630	9128967
28410E/2842C	31 7/8 x 30 7/8	1693159	2791059	1191059	0381159	9048278	9073629	9128966
2852E/2846C/28510RC	31 7/8 x 32 7/8	1693158	2791058	1191058	0381158	9048277	9073628	9128965
2856E	31 7/8 x 34 7/8	1693157	2791057	1191057	0381157	9048276	9073627	9128964
28510E/28410C/2862RC	31 7/8 x 36 7/8	1693156	2791056	1191056	0381156	9048275	9073626	9128963
2862E/2852C	31 7/8 x 38 7/8	1693155	2791055	1191055	0381155	9048274	9073625	9128962
2856C (4/2017 - Present)	31 7/8 x 40 3/8	9153173	9153172	9153171	9153170	9153168	9153169	9153167
2862C/28510C/2856C	31 7/8 x 40 7/8	1693350	2791250	1191250	0381350	9048441	9073792	9129129

28

Insect Screens

Insect Screen - Half / Standard Mesh (4/2007 - Present)

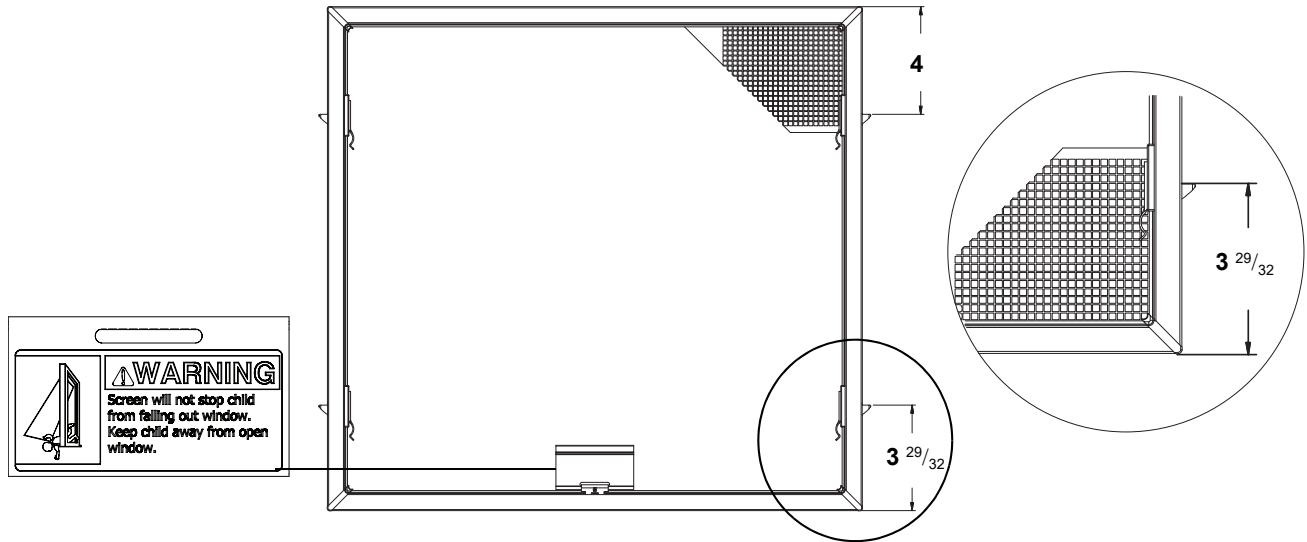

Tilt-Wash (DC) and Tilt-Wash II (TW) Half Insect Screen

Unit No.	Dimensions (w x h)	White	Terra-tone®	Sand-tone	Forest Green	Canvas	Dark Bronze	Black
210210E/21036RC/21032RC	33 7/8 x 18 7/8	1693152	2791052	1191052	0381152	9048273	9073624	9128961
21032E/210310RC	33 7/8 x 20 7/8	1693151	2791051	1191051	0381151	9048272	9073623	9128960
21036E/21032C/21042RC	33 7/8 x 22 7/8	1693150	2791050	1191050	0381150	9048271	9073622	9128959
210310E <i>(9/2017 - Present)</i>	33 7/8 x 24 3/8	9168621	9168639	9168587	9168569	9168531	9168598	9168551
210310E <i>(2007 - 8/2017)</i>	33 7/8 x 24 7/8	1693149	2791049	1191049	0381149	9048270	9073621	9128958
21042E/21036C/21052RC	33 7/8 x 26 7/8	1693148	2791048	1191048	0381148	9048269	9073620	9128957
21046E/21056RC <i>(4/2017 - Present)</i>	33 7/8 x 28 3/8	9153103	9153102	9153101	9153100	9153098	9153099	9153097
21046E/210310C/21056RC <i>(2007 - 3/2017)</i>	33 7/8 x 28 7/8	1693147	2791047	1191047	0381147	9048268	9073619	9128956
210410E/21042C	33 7/8 x 30 7/8	1693146	2791046	1191046	0381146	9048267	9073618	9128955
21052E/21046C/210510RC	33 7/8 x 32 7/8	1693145	2791045	1191045	0381145	9048266	9073617	9128954
21056E	33 7/8 x 34 7/8	1693144	2791044	1191044	0381144	9048265	9073616	9128953
210510E/210410C/21062RC	33 7/8 x 36 7/8	1693143	2791043	1191043	0381143	9048264	9073615	9128952
21062E/21052C	33 7/8 x 38 7/8	1693142	2791042	1191042	0381142	9048263	9073614	9128951
21056C <i>(4/2017 - Present)</i>	33 7/8 x 40 3/8	9153113	9153112	9153111	9153110	9153108	9153109	9153107
21062C/210510C/21056C <i>(2007 - 3/2017)</i>	33 7/8 x 40 7/8	1693349	2791249	1191249	0381349	9048440	9073791	9129128

210

400 Series Tilt-Wash PG Upgrade Windows (2003 to Present)

DP Upgrade Windows

Insect Screens

Insect Screen - Half / Standard Mesh (4/2007 - Present)

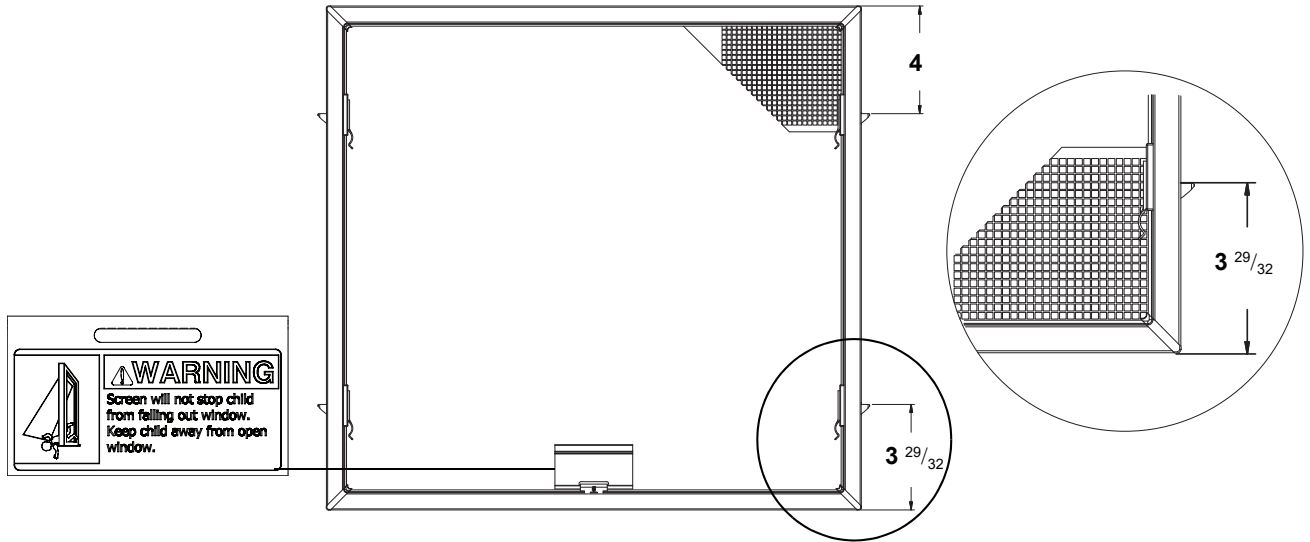

Tilt-Wash (DC) and Tilt-Wash II (TW) Half Insect Screen

Unit No.	Dimensions (w x h)	Color Options							
		White	Terra-tone®	Sand-tone	Forest Green	Canvas	Dark Bronze	Black	
30210E/3036RC/3032RC	35 7/8 x 18 7/8	1693139	2791039	1191039	0381139	9048262	9073613	9128950	
3032E/30310RC	35 7/8 x 20 7/8	1693138	2791038	1191038	0381138	9048261	9073612	9128949	
3036E/3032C/3042RC	35 7/8 x 22 7/8	1693137	2791037	1191037	0381137	9048260	9073611	9128948	
30310E (9/2017 - Present)	35 7/8 x 24 3/8	9168620	9168638	9168586	9168568	9168530	9168597	9168550	
30310E (2007 - 8/2017)	35 7/8 x 24 7/8	1693136	2791036	1191036	0381136	9048259	9073610	9128947	
3042E/3036C/3052RC	35 7/8 x 26 7/8	1693135	2791035	1191035	0381135	9048258	9073609	9128946	
3046E/3056RC (4/2017 - Present)	35 7/8 x 28 3/8	9153183	9153182	9153181	9153180	9153178	9153179	9153177	
3046E/30310C/3056RC (2007 - 3/2017)	35 7/8 x 28 7/8	1693134	2791034	1191034	0381134	9048257	9073608	9128945	
30410E/3042C	35 7/8 x 30 7/8	1693133	2791033	1191033	0381133	9048256	9073607	9128944	
3052E/3046C/30510RC	35 7/8 x 32 7/8	1693132	2791032	1191032	0381132	9048255	9073606	9128943	
3056E	35 7/8 x 34 7/8	1693131	2791031	1191031	0381131	9048254	9073605	9128942	
30510E/30410C/3062RC	35 7/8 x 36 7/8	1693130	2791030	1191030	0381130	9048253	9073604	9128941	
3062E/3052C	35 7/8 x 38 7/8	1693129	2791029	1191029	0381129	9048252	9073603	9128940	
3056C (4/2017 - Present)	35 7/8 x 40 3/8	9153193	9153192	9153191	9153190	9153188	9153189	9153187	
3062C/30510C/3056C (2007 - 3/2017)	35 7/8 x 40 7/8	1693348	2791248	1191248	0381348	9048439	9073790	9129127	

30

Insect Screens

Insect Screen - Half / Standard Mesh (4/2007 - Present)

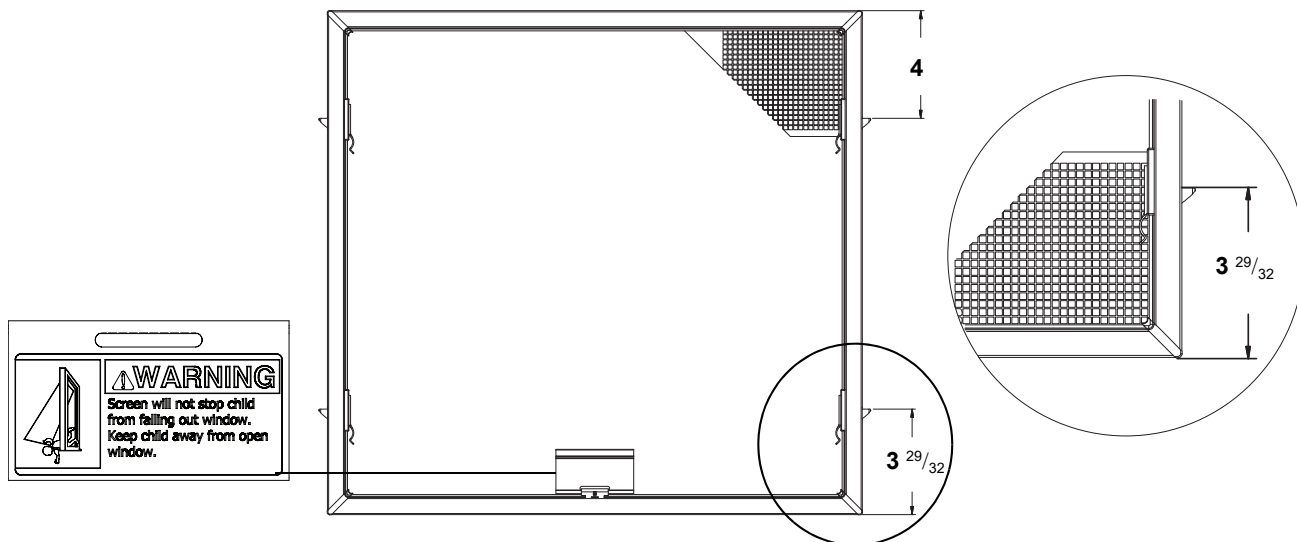

Tilt-Wash (DC) and Tilt-Wash II (TW) Half Insect Screen

Unit No.	Dimensions (w x h)	White	Terra-tone®	Sand-tone	Forest Green	Canvas	Dark Bronze	Black
34210E/3436RC/3432RC	39 7/8 x 18 7/8	1693126	2791026	1191026	0381126	9048251	9073602	9128939
3432E/34310RC	39 7/8 x 20 7/8	1693125	2791025	1191025	0381125	9048250	9073601	9128938
3436E/3432C/3442RC	39 7/8 x 22 7/8	1693124	2791024	1191024	0381124	9048249	9073600	9128937
34310E <i>(9/2017 - Present)</i>	39 7/8 x 24 3/8	9168619	9168637	9168585	9168567	9168529	9168547	9168549
34310E <i>(2007 - 8/2017)</i>	39 7/8 x 24 7/8	1693123	2791023	1191023	0381123	9048248	9073599	9128936
3442E/3436C/3452RC	39 7/8 x 26 7/8	1693122	2791022	1191022	0381122	9048247	9073598	9128935
3446E/3056RC <i>(4/2017 - Present)</i>	39 7/8 x 28 3/8	9153203	9153202	9153201	9153200	9153198	9153199	9153197
34 3446E/34310C/3456RC <i>(2007 - 3/2017)</i>	39 7/8 x 28 7/8	1693121	2791021	1191021	0381121	9048246	9073597	9128934
34410E/3442C	39 7/8 x 30 7/8	1693120	2791020	1191020	0381120	9048245	9073596	9128933
3452E/3446C/34510RC	39 7/8 x 32 7/8	1693119	2791019	1191019	0381119	9048244	9073595	9128932
3456E	39 7/8 x 34 7/8	1693118	2791018	1191018	0381118	9048243	9073594	9128931
34510E/34410C/3462RC	39 7/8 x 36 7/8	1693117	2791017	1191017	0381117	9048242	9073593	9128930
3462E/3452C	39 7/8 x 38 7/8	1693116	2791016	1191016	0381116	9048241	9073592	9128929
3456C <i>(4/2017 - Present)</i>	39 7/8 x 40 3/8	9153212	9153211	9153210	9153209	9153207	9153208	9153206
3462C/34510C/3456C <i>(2007 - 3/2017)</i>	39 7/8 x 40 7/8	1693347	2791247	1191247	0381347	9048438	9073789	9129126

400 Series Tilt-Wash PG Upgrade Windows (2003 to Present)

DP Upgrade Windows

Insect Screens

Insect Screen - Half / Standard Mesh (4/2007 - Present)

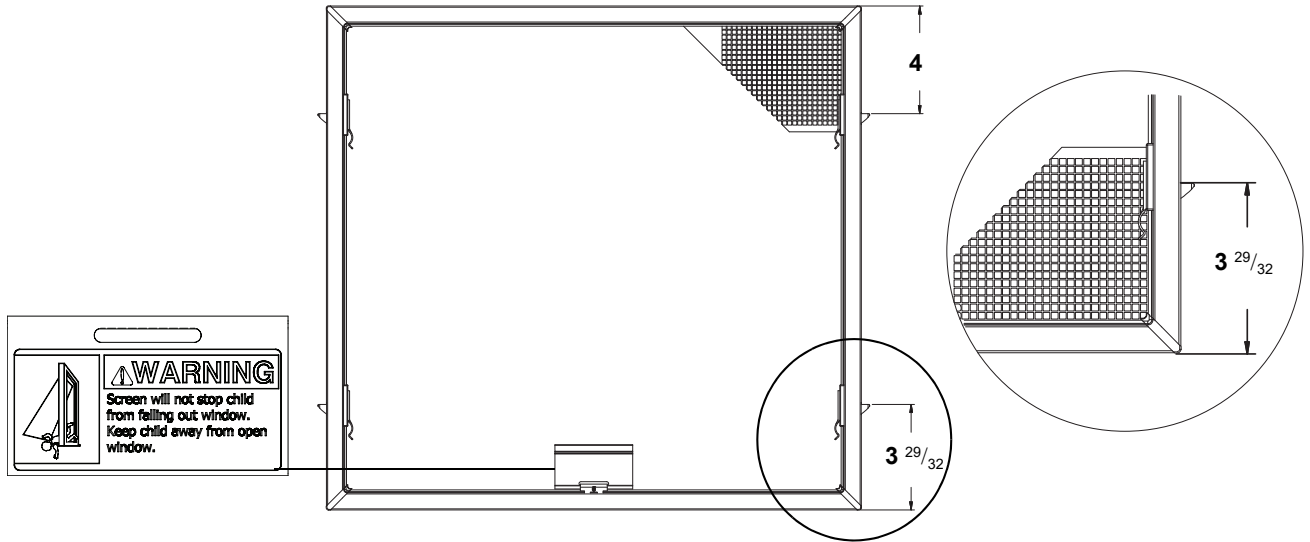

Tilt-Wash (DC) and Tilt-Wash II (TW) Half Insect Screen

Unit No.	Dimensions (w x h)	Color Options						
		White	Terra-tone®	Sand-tone	Forest Green	Canvas	Dark Bronze	Black
38210E/3836RC/3832RC	43 7/8 x 18 7/8	1693113	2791013	1191013	0381113	9048240	9073591	9128928
3832E/38310RC	43 7/8 x 20 7/8	1693112	2791012	1191012	0381112	9048239	9073590	9128927
3836E/3832C/3842RC	43 7/8 x 22 7/8	1693111	2791011	1191011	0381111	9048238	9073589	9128926
38310E (9/2017 - Present)	43 7/8 x 24 3/8	9168618	9168636	9168584	9168566	9168528	9168546	9168548
38310E (2007 - 8/2017)	43 7/8 x 24 7/8	1693110	2791010	1191010	0381110	9048237	9073588	9128925
3842E/3836C/3852RC	43 7/8 x 26 7/8	1693109	2791009	1191009	0381109	9048236	9073587	9128924
3446E/3056RC (4/2017 - Present)	39 7/8 x 28 3/8	9153222	9153221	9153220	9153219	9153217	9153218	9153216
3846E/38310C/3856RC (2007 - 3/2017)	43 7/8 x 28 7/8	1693108	2791008	1191008	0381108	9048235	9073586	9128923
38410E/3842C	43 7/8 x 30 7/8	1693107	2791007	1191007	0381107	9048234	9073585	9128922
3852E/3846C/38510RC	43 7/8 x 32 7/8	1693106	2791006	1191006	0381106	9048233	9073584	9128921
3856E	43 7/8 x 34 7/8	1693105	2791005	1191005	0381105	9048232	9073583	9128920
38510E/38410C/3862RC	43 7/8 x 36 7/8	1693104	2791004	1191004	0381104	9048231	9073582	9128919
3862E/3852C	43 7/8 x 38 7/8	1693103	2791003	1191003	0381103	9048230	9073581	9128918
3456C (4/2017 - Present)	39 7/8 x 40 3/8	9153231	9153230	9153229	9153228	9153226	9153227	9153225
3862C/38510C/3856C (2007 - 3/2017)	43 7/8 x 40 7/8	1693346	2791246	1191246	0381346	9048437	9073788	9129125

38

Insect Screens

Insect Screen Bug Seal - Half

Bug Seal Assembly - Insect Screen



Unit No.	Length	White	Terratone®	Sandtone	Forest Green	Canvas	Dark Bronze	Black
18	19 3/4	1693408	2791255	1191304	0381355	9076687	9076919	9129179
20	23 3/4	1693409	2791256	1191305	0381356	9076688	9076920	9129180
24	27 3/4	1693410	2791257	1191306	0381357	9076689	9076921	9129181
26	29 3/4	1693411	2791258	1191307	0381358	9076690	9076922	9129182
28	31 3/4	1693412	2791259	1191308	0381359	9076691	9076923	9129183
210	33 3/4	1693413	2791260	1191309	0381360	9076692	9076924	9129184
30	35 3/4	1693414	2791261	1191310	0381361	9076693	9076925	9129185
34	39 3/4	1693415	2791262	1191311	0381362	9076694	9076926	9129186
38	43 3/4	1693416	2791263	1191312	0381363	9076695	9076927	9129187

Bug Seal Pile - Half Insect Screen

	Length	Order No.
	41 25/64	1693407

400 Series Tilt-Wash PG Upgrade Windows (2003 to Present)

DP Upgrade Windows

Insect Screens

Insect Screen Hardware

Finger Pull - Insect Screen / Full

	Order No.
	8121701

Screen Label with Clip

	Order No.
	1631110

Latches - Insect Screen (Pair)

Note:

Complete screen assembly replacement is recommended if this component part is damaged.

	Color	Order No.
	White	1693417
	Terratone®	2791264
	Sandtone	1191313
	Forest Green	0381364
	Canvas	9014568
	Dark Bronze	9076928
	Black	9014573

Screws - Bug Seal / Half

Note:

Screws only used with non-white colors listed.

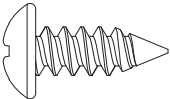
	Color	Order No.
	Terratone®	9176415
	Sandtone	9176414
	Forest Green	9176416
	Canvas	9176261
	Dark Bronze	9176417
	Black	9176418

Frames

Frame Assembly Graphic

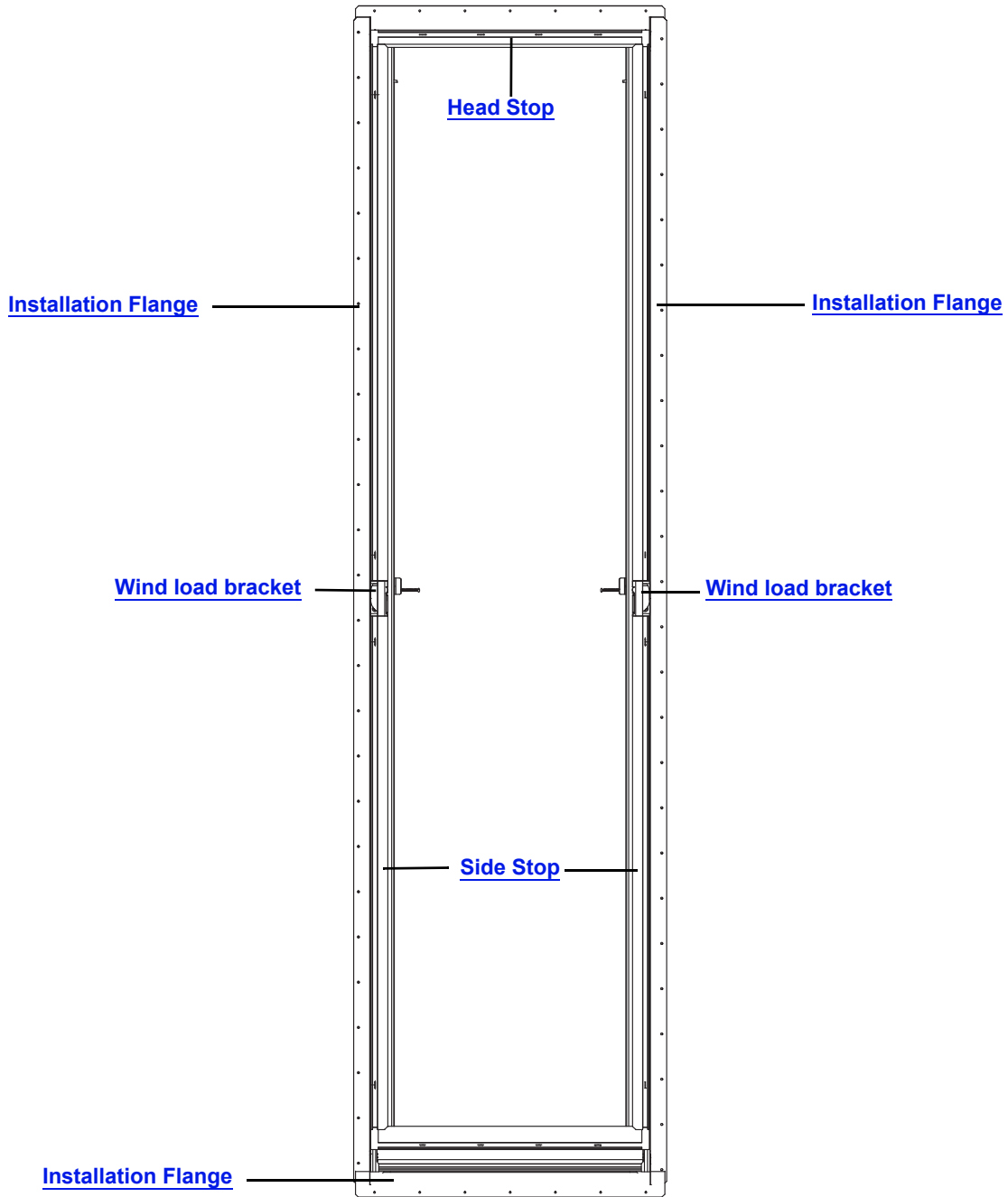

Tilt-Wash DP Upgrade Frame Assembly

Frames

Note:

Service Replacement only.

To order, state:

Product ID (from product label, see [Service Guide 9051877](#))

OR

- 1. Unit size (400TW DP Upgrade size W x H dimensions)**
- 2. Unit sash ratio (Even)**
- 3. Description of part (Replacement Frame)**
- 4. Manufacturing Date**
- 5. Exterior color of frame**
- 6. Interior finish of inside stops**
- 7. Jamb liner color (white or grey)**
- 8. Glass Type (required when ordering frame w/ balancers)**

Stops - Head/Sill (2004 - Present)

Stop - Head / Sill (2004 - Present)

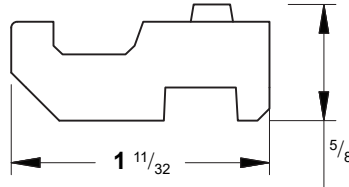

Unit No.	Length	Natural Wood	White	Terra-tone®	Sandtone	Forest Green	Canvas	Dark Bronze	Black
TW18	21 9/16	1642210	1642240	1687014	1159020	1687016	9047293	9077130	9129522
TW20	25 9/16	1642211	1642241	1687018	1159021	1687019	9047294	9077131	9129523
TW24	29 9/16	1642212	1642242	1687020	1159022	1687021	9047295	9077132	9129524
TW26	31 9/16	1642217	1642252	1687030	1159028	1687031	9047300	9077137	9129529
TW28	33 9/16	1642213	1642243	1687022	1159023	1687023	9047296	9077133	9129525
TW210	35 9/16	1642218	1642253	1687032	1159029	1687033	9047301	9077138	9129530
TW30	37 9/16	1642214	1642244	1687024	1159024	1687025	9047297	9077134	9129526
TW34	41 9/16	1642215	1642245	1687026	1159025	1687027	9047298	9077135	9129527
TW38	45 9/16	1642216	1642246	1687028	1159026	1687029	9047299	9077136	9129528

Stops - Sill (DP Upgrade and Impact Resistant) (4/2007 - Present)

Inside Stop - Sill / Tall / 2 1/16" (4/2007 - Present)

Note:
Replaces previous vintages.

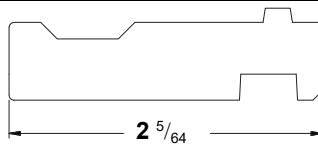

Unit No.	Dimensions	Natural Wood	Prefinished White Interior	Canvas	Dark Bronze
TW18	21 9/16	1690629	1690638	9072054	9073827
TW20	25 9/16	1690630	1690639	9072055	9073828
TW24	29 9/16	1690631	1690640	9072056	9073829
TW26	31 9/16	1690634	1690643	9072057	9073832
TW28	33 9/16	1690632	1690641	9072058	9073830
TW210	35 9/16	1690635	1690644	9072062	9073833
TW30	37 9/16	1690633	1690642	9072059	9073831
TW34	41 9/16	1690636	1690645	9072060	9073834
TW38	45 9/16	1690637	1690646	9072061	9073835

Inside Stop - Sill / Tall 2 1/16" (2004 - 3/2007)

Note:
No longer available. Use 4/2007 to present for replacement. For DP upgrade units also replace side stop. For IR units, also replace side stops and lower corner bracket with flipout wind load bracket.

400 Series Tilt-Wash PG Upgrade Windows (2003 to Present)

DP Upgrade Windows

Frames

Stops - Side

Stop - Side (August 2018 - Present)

Note:
Configured in iQ+.

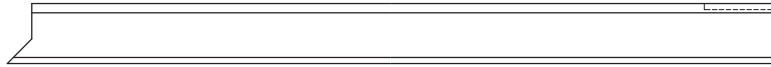
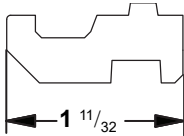

Unit No.	Length	Natural Wood		Vinyl Wrapped (PVC) White	
		Left	Right	Left	Right
210E	15 1/2	Configured	Configured	Configured	Configured
310C/32E	17 1/2	Configured	Configured	Configured	Configured
42C/36E	19 1/2	Configured	Configured	Configured	Configured
410C/46C/310E	21 1/2	Configured	Configured	Configured	Configured
52C/42E	23 1/2	Configured	Configured	Configured	Configured
56C	25 1/2	Configured	Configured	Configured	Configured
46E	25 1/2	Configured	Configured	Configured	Configured
410E	27 1/2	Configured	Configured	Configured	Configured
52E	29 1/2	Configured	Configured	Configured	Configured
56E	31 1/2	Configured	Configured	Configured	Configured
510E	33 1/2	Configured	Configured	Configured	Configured
62E	35 1/2	Configured	Configured	Configured	Configured

Frames

Vintage Stops - Side

Stop - Side / Upper (2007 - 7/2018)

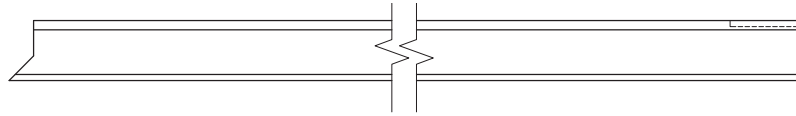
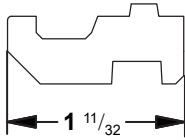

Unit No.	Length	Natural Wood		Vinyl Wrapped (PVC) White	
		Left	Right	Left	Right
210E	15 1/2	OBD/Configured	OBD/Configured	OBD/Configured	OBD/Configured
310C/32E	17 1/2	OBD/Configured	OBD/Configured	OBD/Configured	OBD/Configured
42C/36E	19 1/2	OBD/Configured	OBD/Configured	OBD/Configured	OBD/Configured
410C/46C/310E	21 1/2	OBD/Configured	OBD/Configured	OBD/Configured	OBD/Configured
52C/42E	23 1/2	OBD/Configured	OBD/Configured	OBD/Configured	OBD/Configured
56C	25 1/2	OBD/Configured	OBD/Configured	OBD/Configured	OBD/Configured
46E	25 1/2	OBD/Configured	OBD/Configured	OBD/Configured	OBD/Configured
410E	27 1/2	OBD/Configured	OBD/Configured	OBD/Configured	OBD/Configured
52E	29 1/2	OBD/Configured	OBD/Configured	OBD/Configured	OBD/Configured
56E	31 1/2	OBD/Configured	OBD/Configured	OBD/Configured	OBD/Configured
510E	33 1/2	OBD/Configured	OBD/Configured	OBD/Configured	OBD/Configured
62E	35 1/2	OBD/Configured	OBD/Configured	OBD/Configured	OBD/Configured

Stop - Side / Lower (2007 - 7/2018)

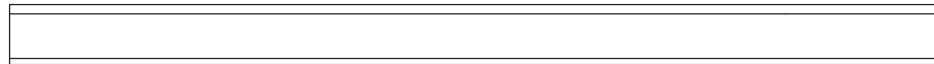
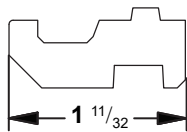

Unit No.	Length	Natural Wood	Vinyl Wrapped (PVC) White
210E	13 7/32	OBD/Configured	OBD/Configured
32E	15 7/32	OBD/Configured	OBD/Configured
36E	17 7/32	OBD/Configured	OBD/Configured
310E	19 7/32	OBD/Configured	OBD/Configured
42E	21 7/32	OBD/Configured	OBD/Configured
310C/46E	23 7/32	OBD/Configured	OBD/Configured
42C/410E	25 7/32	OBD/Configured	OBD/Configured
46C/52E	27 7/32	OBD/Configured	OBD/Configured
56E	29 7/32	OBD/Configured	OBD/Configured
410C/510E	31 7/32	OBD/Configured	OBD/Configured
52C/62E	33 7/32	OBD/Configured	OBD/Configured
56C	35 7/32	OBD/Configured	OBD/Configured

400 Series Tilt-Wash PG Upgrade Windows (2003 to Present)

DP Upgrade Windows

Frames

Extension Jamb / Wood / Lineal									
Extension Jamb / Wood / Lineal									
Wall Depth	Dim A	Pine		Oak		Maple			
		96"	144"	96"	144"	96"	144"		
5"	5	15/32	N/A	N/A	N/A	N/A	N/A	N/A	
	5 1/16	17/32	9104431	9104427	9104433	9104429	9104434		
	5 1/8	19/32	9104439	9104435	9104441	9104437	9104442		
	5 3/16	21/32	9104447	9104443	9104449	9104445	9104450		
	5 1/4	23/32	1636627	1636628	9104419	9104416	9104420	9104417	
	5 5/16	25/32	9104455	9104451	9104457	9104453	9104458		
	5 3/8	27/32	9104463	9104459	9104465	9104461	9104466		
	5 7/16	29/32	9104471	9104467	9104473	9104469	9104474		
	5 1/2	31/32	9104479	9104475	9104481	9104477	9104482		
	5 9/16	1 1/32	9104487	9104483	9104489	9104485	9104490		
	5 5/8	1 3/32	9104495	9104491	9104497	9104493	9104498		
	5 11/16	1 5/32	9104503	9104499	9104505	9104501	9104506		
	5 3/4	1 7/32	9104511	9104507	9104513	9104509	9104514		
	5 13/16	1 9/32	9104519	9104515	9104521	9104517	9104522		
	5 7/8	1 11/32	9104527	9104523	9104529	9104525	9104530		
5 15/16	1 13/32	9104535	9104531	9104537	9104533	9104538			
6"	6	1 15/32	9104543	9104539	9104545	9104541	9104546		
	6 1/16	1 17/32	9104551	9104547	9104553	9104549	By description		
	6 1/8	1 19/32	9104559	9104555	9104561	9104557	9104562		
	6 3/16	1 21/32	9104467	9104563	9104569	9104565	9104570		
	6 1/4	1 23/32	9104575	9104571	9104577	9104573	9104578		
	6 5/16	1 25/32	9104583	9104579	9104585	9104581	9104586		
	6 3/8	1 27/32	9104591	9104587	9104593	9104589	9104594		
	6 7/16	1 29/32	9104599	9104595	9104601	9104597	9104602		
	6 1/2	1 31/32	9104607	9104603	9104609	9104605	9104610		
	6 9/16	2 1/32	1636637	1636638	9104413	9104411	9104414	9104412	
	6 5/8	2 3/32	9104615	9104611	9104617	9104613	9104618		
	6 11/16	2 5/32	9104623	9104619	9104625	9104621	9104626		
	6 3/4	2 7/32	9104631	9104627	9104633	9104629	9104634		
	6 13/16	2 9/32	9104639	9104635	9104641	9104637	9104642		
	6 7/8	2 11/32	9104647	9104643	9104649	9104645	9104650		
6 15/16	2 13/32	9104655	9104651	9104657	9104653	9104658			
7"	7	2 15/32	9104663	9104659	9104665	9104661	9104666		
	7 1/16	2 17/32	9104671	9104667	9104673	9104669	9104674		
	7 1/8	2 19/32	1636647	1636648	9104425	9104422	9104426	9104423	

Frames

Extension Jamb / Painted / Lineal												
Extension Jamb / Painted / Lineal												
Wall Depth	Dim A	White Painted		White Vinyl Wrapped		Dark Bronze Painted		Black Painted		Sandtone Painted		
		96"	144"	96"	144"	96"	144"	96"	144"	96"	144"	
5"	5	15/32	N/A	N/A	N/A	N/A	N/A	N/A	N/A	N/A	N/A	N/A
	5 1/16	17/32	By description	By description	N/A	N/A	9145388	9145387	9144790	9144789	N/A	N/A
	5 1/8	19/32	By description	By description	N/A	N/A	9145390	9145389	9144792	9144791	N/A	N/A
	5 3/16	21/32	By description	By description	N/A	N/A	9145392	9145391	9144794	9144793	N/A	N/A
	5 1/4	23/32	1694669	1694670	N/A	N/A	9145384	9145383	9144786	9144785	N/A	N/A
	5 5/16	25/32	By description	By description	N/A	N/A	9145394	9145393	9144796	9144795	N/A	N/A
	5 3/8	27/32	By description	By description	N/A	N/A	9145396	9145395	9144798	9144797	N/A	N/A
	5 7/16	29/32	By description	By description	N/A	N/A	9145398	9145397	9144800	9144799	N/A	N/A
	5 1/2	31/32	By description	By description	N/A	N/A	9145400	9145399	9144802	9144801	N/A	N/A
	5 9/16	1 1/32	By description	By description	N/A	N/A	9145402	9145401	9144804	9144803	N/A	N/A
	5 5/8	1 3/32	By description	By description	N/A	N/A	9145404	9145403	9144806	9144805	N/A	N/A
	5 11/16	1 5/32	By description	By description	N/A	N/A	9145406	9145405	9144808	9144807	N/A	N/A
	5 3/4	1 7/32	By description	By description	N/A	N/A	9145408	9145407	9144810	9144809	N/A	N/A
	5 13/16	1 9/32	By description	By description	N/A	N/A	9145410	9145409	9144812	9144811	N/A	N/A
6"	5 7/8	1 11/32	By description	By description	N/A	N/A	9145412	9145411	9144814	9144813	N/A	N/A
	5 15/16	1 13/32	By description	By description	N/A	N/A	9145414	9145413	9144816	9144815	N/A	N/A
	6	1 15/32	By description	By description	N/A	N/A	9145416	9145415	9144818	9144817	N/A	N/A
	6 1/16	1 17/32	By description	By description	N/A	N/A	9145418	9145417	9144820	9144819	N/A	N/A
	6 1/8	1 19/32	By description	By description	N/A	N/A	9145420	9145419	9144822	9144821	N/A	N/A
	6 3/16	1 21/32	By description	By description	N/A	N/A	9145422	9145421	9144824	9144823	N/A	N/A
	6 1/4	1 23/32	By description	By description	N/A	N/A	9145424	9145423	9144826	9144825	N/A	N/A
	6 5/16	1 25/32	By description	By description	N/A	N/A	9145426	9145425	9144828	9144827	N/A	N/A
	6 3/8	1 27/32	By description	By description	N/A	N/A	9145428	9145427	9144830	9144829	N/A	N/A
	6 7/16	1 29/32	By description	By description	N/A	N/A	9145430	9145429	9144832	9144831	N/A	N/A
	6 1/2	1 31/32	By description	By description	N/A	N/A	9145432	9145431	9144834	9144833	N/A	N/A
	6 9/16	2 1/32	1694628	1694629	N/A	N/A	9146080	9146081	9146066	9146067	9164689	9164682
	6 5/8	2 3/32	By description	By description	N/A	N/A	9145434	9145433	9144836	9144835	N/A	N/A
	6 11/16	2 5/32	By description	By description	N/A	N/A	9145436	9145435	9144838	9144837	N/A	N/A
6 3/4	2 7/32	By description	By description	N/A	N/A	9145438	9145437	9144840	9144839	N/A	N/A	
7"	6 13/16	2 9/32	By description	By description	N/A	N/A	9145440	9145439	9144842	9144841	N/A	N/A
	6 7/8	2 11/32	By description	By description	N/A	N/A	9145442	9145441	9144844	9144843	N/A	N/A
	6 15/16	2 13/32	By description	By description	N/A	N/A	9145444	9145443	9144846	9144845	N/A	N/A
	7	2 15/32	By description	By description	N/A	N/A	9145446	9145445	9144848	9144847	N/A	N/A
	7 1/16	2 17/32	By description	By description	N/A	N/A	9145448	9145447	9144850	9144849	N/A	N/A
	7 1/8	2 19/32	1694711	1694712	N/A	N/A	9145386	9145385	9144788	9144787	N/A	N/A

400 Series Tilt-Wash PG Upgrade Windows (2003 to Present)



DP Upgrade Windows

Frames

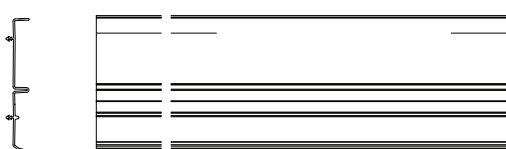
Jamb Liners					
Jamb Liner - Side					
Note: Handing for side Jamb Liners is determined based on the exterior view of the unit. Jamb liner includes balancer covers, chimney plug, head/sill plugs, wash assist, wash assist stop and weatherstrip.					
Unit No.	Length	White		Gray	
		Left	Right	Left	Right
TW210	34 ³ / ₃₂	1681160	1681170	2774390	2774290
TW32	38 ³ / ₃₂	1681161	1681171	2774391	2774291
TW36	42 ³ / ₃₂	1681159	1681178	2713722	2713716
TW310 <i>(9/2017 - Present)</i>	46 ³ / ₃₂	9168699	9168700	9168702	9168701
TW310 <i>(1992 - 8/2017)</i>	46 ³ / ₃₂	OBD	OBD	OBD	OBD
TW310C	46 ³ / ₃₂	1681472	9068871	2713736	9068870
TW42	50 ³ / ₃₂	1681163	1681173	2774393	2774293
TW42C	50 ³ / ₃₂	1681473	9068875	2713737	9068874
TW46 <i>(4/2017 - Present)</i>	54 ³ / ₃₂	1681164	1681174	2774394	2774294
TW46 <i>(1992 - 3/2017)</i>	54 ³ / ₃₂	OBD	OBD	OBD	OBD
TW46C	54 ³ / ₃₂	1681474	9068877	2713738	9068876
TW410	58 ³ / ₃₂	1681168	1681179	2713723	2713717
TW410C	58 ³ / ₃₂	1681476	9068873	2713731	9068872
TW52	62 ³ / ₃₂	1681165	1681175	2774395	2774295
TW52C	62 ³ / ₃₂	1681475	9068879	2713739	9068878
TW56E	66 ³ / ₃₂	1681715	1681716	2779902	2779901
TW56C <i>(4/2017 - Present)</i>	66 ³ / ₃₂	1681166	1681176	2774396	2774296
TW56C <i>(1992 - 3/2017)</i>	66 ³ / ₃₂	OBD	OBD	OBD	OBD
TW510	70 ³ / ₃₂	1681169	1681189	2713724	2713718
TW62	74 ³ / ₃₂	1681167	1681177	2774397	2774297

Liner with Label - Head Jamb (2007 - Present)				
Note: Units manufactured after 10/06 do not have head jamb liner screws. Screws are not included with the head jamb liner listed below. Liner secured by pressing two barbed legs into head jamb.				
	Unit No.	Length	White	Gray
	TW18	20	1682270	2775770
	TW20	24	1682271	2775771
	TW24	28	1682272	2775772
	TW26	30	1682277	2775777
	TW28	32	1682273	2775773
	TW210	34	1682278	2775778
	TW30	36	1682274	2775774
	TW34	40	1682275	2775775
	TW38	44	1682276	2775776

Frames

Wash Assist			
 <p>parts.andersenwindows.com</p>		Gray	
		1643027	
Stop - Wash Assist			
 <p>parts.andersenwindows.com</p>		Color	Order No.
		Gray	1643028

400 Series Tilt-Wash PG Upgrade Windows (2003 to Present)

DP Upgrade Windows

Frames

Balancer Cover Table (6/2017 - Present)

Note:

Upper balancer cover is 2" shorter than lower balancer cover.

Cover - Balancer / Even (6/2017 - Present)

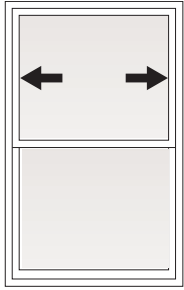
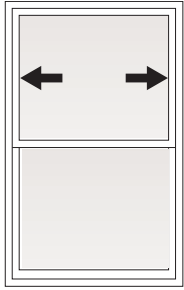
		Unit No.	White		Gray	
			Upper	Lower	Upper	Lower
		TW210	9170294	1618101	9170295	2712670
		TW32	1618101	1618102	2712670	2712671
		TW36	1618102	1618097	2712671	2713725
		TW310	9169132	9169131	9169134	9169133
		TW42	1618103	1618104	2712672	2712673
		TW46	9170292	9162498	9170293	9162499
		TW410	1618105	1618098	2712674	2713726
		TW52	1618098	1618106	2713726	2712675
		TW56E	1618106	1681719	2712675	2779905
		TW510	1681719	1618099	2779905	2713727
		TW62	1618108	9171496	2712677	9171497

Cover - Balancer / Cottage (6/2017 - Present)

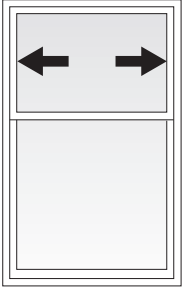
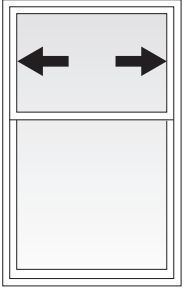
		Unit No.	White		Gray	
			Upper	Lower	Upper	Lower
		TW32C	9170294	1618101	9170295	2712670
		TW36C	9170294	1618101	9170295	2712670
		TW310C	1618101	1618102	2712670	2712671
		TW42C	1618102	1618097	2712671	2713725
		TW46C	1618097	1618103	2713725	2712672
		TW410C	1618097	1618103	2713725	2712672
		TW52C	1618103	1618104	2712672	2712673
		TW56C	9170292	9162498	9170293	9162499
		TW510C	1618104	1618105	2712673	2712674
		TW62C	1618105	1618098	2712674	2713726

Frames

Vintage Balancer Cover Table (1992 - 8/2017)

Cover - Balancer / Even (1992 - 8/2017)

Note:

Used for both upper and lower balancer covers.

	Unit No.	White	Gray
	TW210	1618101	2712670
	TW32	1618102	2712671
	TW36	1618097	2713725
	TW310	1618103	2712672
	TW42	1618104	2712673
	TW46	1618105	2712674
	TW410	1618098	2713726
	TW52	1618106	2712675
	TW56E	1681719	2779905
	TW56	1618105	2712674
	TW510	1618099	2713727
	TW62	1618108	2712677

Cover - Support

	Color	(1992 - 8/2017)	(9/2017 - Present)
		1"	4 5/8"
	White	1618109	9043713
	Gray	2712678	9043714

400 Series Tilt-Wash PG Upgrade Windows (2003 to Present)

DP Upgrade Windows

Frames

Flange			
Nailing Flange - Side (Pair)			
	Unit No.	Length	Order No.
	TW210	28 ²¹ / ₆₄	1635020
	TW32	42 ²¹ / ₆₄	1635021
	TW36	46 ²¹ / ₆₄	1635022
	TW310	50 ²¹ / ₆₄	1635023
	TW42	54 ²¹ / ₆₄	1635024
	TW46	58 ²¹ / ₆₄	1635025
	TW410	62 ²¹ / ₆₄	1635026
	TW52	66 ²¹ / ₆₄	1635027
	TW56	70 ²¹ / ₆₄	1635028
	TW510	74 ²¹ / ₆₄	1635029
	TW62	78 ²¹ / ₆₄	1635030
Nailing Flange - Head and Sill			
Note:			
Ships as one.			
	Unit No.	Length	Order No.
	TW18	23 ¹⁵ / ₁₆	1625460
	TW20	27 ¹⁵ / ₁₆	1625461
	TW24	31 ¹⁵ / ₁₆	1625462
	TW26	33 ¹⁵ / ₁₆	1625472
	TW28	35 ¹⁵ / ₁₆	1625463
	TW210	37 ¹⁵ / ₁₆	1625473
	TW30	39 ¹⁵ / ₁₆	1625464
	TW34	43 ¹⁵ / ₁₆	1625465
	TW38	47 ¹⁵ / ₁₆	1625466

Frames

Frame Hardware

Note:

Colors not shown available by description.

Screw - Bracket / Outer Frame Member Bracket (Stormwatch)

Description	White	Terra-tone®	Sandtone	Forest Green	Canvas	Dark Bronze
#8-15 x 1-1/4 Typ A PH FL 18-8 SS	3629085	3629087	3629086	3629088	9072073	9073802
#8-15 x 3 Typ A PH FL 18-8 SS	3629089	3629091	3629090	3629092	9072072	9073803
	Black					
#8-15 x 1-1/4 Typ A PH FL 18-8 SS	9129190					
#8-15 x 3 Typ A PH FL 18-8 SS	9129191					

Bracket - Frame Tie (4/2007 - Present)

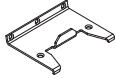
	Order No.
	1690604

Bracket with Screws - Outer Frame Member (Stormwatch)

	<p>Note: Used to replace previous vintages.</p>	Color	Order No.
		White	1630139
		Terratone®	2743023
		Sandtone	1166002
		Forest Green	0375102
		Black	9133908
		Dark Bronze	9133909
Canvas	9133910		

Bracket - Wind Load Kit (4/2007 - Present)

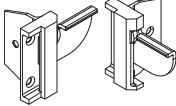
	<p>Kit includes: 1 right hand and 1 left hand wind load bracket.</p>	Dimensions	Color	Order No.
		1 11/32 x 2 23/32	Stone	2743028
			White	1690670