

## What's in This Section

<b>2-Panel, 4-Panel, and Stationary</b> .....	<b>Page 5</b>
<b>Parts Illustration</b> .....	<b>5</b>
Parts Illustration - Interior .....	5
Parts Illustration - Exterior .....	6
Parts Illustration - 4-Panel .....	7
Parts Illustration - 2-Panel .....	8
<b>Unit Sizes</b> .....	<b>9</b>
Standard and Custom Door Sizes .....	9
400 Series Product Label .....	9
Unit Size Chart - 6' 8" Height .....	10
Unit Size Chart - 6' 11" Height .....	11
Unit Size Chart - 8' 0" Height .....	12
Panel Handing .....	13
<b>Product History</b> .....	<b>14</b>
Product History .....	14
<b>Panels - Operating</b> .....	<b>15</b>
Operating Panel Graphic .....	15
Operating Panel Size Table .....	16
Operating Panels .....	16
Operating Panel / High Performance Tempered Blinds Between Glass w/Tube .....	17
Operating Panel / High Performance Low-E4® Tempered .....	18
Operating Panel / High Performance Low-E4® Smart Sun Tempered .....	20
Operating Panel / High Performance Low-E4® Sun Tempered .....	21
Operating Panel / High Performance Sun II Tempered .....	22
Operating Panel / High Performance Low-E4® Tempered Finelight™ .....	23
Operating Panel / Stormwatch® .....	25
Operating Panel / DP Upgrade .....	28
Reachout Lock Astragal - Operating - 4-Panel .....	29
Glass Stops - Operating .....	31
Panel Parts - Operating .....	33
<b>Panels - Stationary</b> .....	<b>36</b>
Stationary Panel Graphic .....	36
Stationary Panel Size Table .....	37
Stationary Panels .....	37
Stationary Panel / High Performance Tempered Blinds Between Glass w/Tube .....	38
Stationary Panel / High Performance Low-E4® Tempered .....	39
Stationary Panel / High Performance Low-E4® Smart Sun Tempered .....	41
Stationary Panel / High Performance Low-E4® Sun Tempered .....	42

Stationary Panel / High Performance Sun II Tempered . . . . .	44
Stationary Panel / High Performance Sun Bronze Tempered . . . . .	44
Stationary Panel / High Performance Low-E4® Tempered Finelight™ . . . . .	45
Stationary Panel / Stormwatch® . . . . .	47
Stationary Panel / DP Upgrade . . . . .	50
Glass Stops - Stationary . . . . .	51
Interlock - Set . . . . .	53
Panel Parts - Stationary . . . . .	54
<b>Insect Screens . . . . .</b>	<b>56</b>
Insect Screen Graphic - Gliding 2 & 4-Panel / Current . . . . .	56
Insect Screen Graphic - Gliding 2 & 4-Panel / Vintage . . . . .	57
Gliding Insect Screens - Universal . . . . .	58
Rescreening Kits - Gliding Insect Screen . . . . .	58
Gliding Insect Screen Hardware - 2-Panel . . . . .	59
Vintage Gliding Insect Screen Hardware - 2-Panel . . . . .	61
Gliding Insect Screen Hardware - 4-Panel . . . . .	62
Retractable Insect Screens ( <i>April 2024 - Present</i> ) . . . . .	63
Vintage Retractable Insect Screens ( <i>June 2007 - April 2024</i> ) . . . . .	64
Vintage Retractable Insect Screen Parts ( <i>June 2007 - April 2024</i> ) . . . . .	64
<b>Grilles . . . . .</b>	<b>73</b>
Interior Grilles - Custom . . . . .	73
Interior Grilles - Colonial / 7/8" Wood / Natural Interior . . . . .	73
Interior Grilles - Colonial / 7/8" Wood / Prefinished Interior . . . . .	75
Interior Grilles - Prairie A / 7/8" Wood / Natural Interior . . . . .	76
Interior Grilles - Prairie A / 7/8" Wood / Prefinished Interior . . . . .	78
Interior Grille Parts . . . . .	79
<b>Hardware . . . . .</b>	<b>80</b>
Half Trim Set Kits - Interior . . . . .	80
Half Trim Set Kits - Exterior . . . . .	83
Hardware - Tribeca® . . . . .	84
Hardware - Anvers® . . . . .	87
Hardware - Newbury® . . . . .	90
Hardware - Covington™ . . . . .	94
Hardware - Whitmore® . . . . .	97
Hardware - Encino® . . . . .	101
Hardware - Yuma® . . . . .	104
Hardware - Albany . . . . .	107
Shared Trim Set Parts . . . . .	110
Lock Parts . . . . .	112
Vintage Lock Parts . . . . .	115
Vintage Trim Set Parts . . . . .	116
Screw Packages / Knocked Down Frame . . . . .	118
Screw Packages / Factory Assembled . . . . .	121
Screw Package / Frame (Impact Resistant) / Stormwatch® . . . . .	122

Fasteners .....	123
<b>Frames .....</b>	<b>126</b>
Frame Only .....	127
Jambs .....	134
Trim Piece .....	137
Stops .....	138
Stops - Head Parting / Predrilled .....	139
Head Flashing .....	141
Installation Flanges .....	141
Insect Screen Guide .....	143
Weatherstrip .....	144
Sills .....	145
Filler .....	147
Bracket - 4 Panel .....	148
Frame Parts and Hardware .....	148
Cartons .....	150
Extension Jambs .....	151
Extension Jamb Kits .....	151
Sill Ramp Parts .....	161
Installation Kit .....	162
Fasteners .....	162
<b>Joining Components .....</b>	<b>163</b>
Fiberglass Joining Exploded View .....	163
Fiberglass Joining Kits .....	164
Fiberglass Joining Hardware Kits .....	166
Fiberglass Joining Kit Components .....	167
Narrow Mull Joining Kits .....	171
Vintage LVL Joining Kit Components .....	173
Support Mull Joining Kits .....	175
Universal Drip Cap - Continuous .....	176
<b>Art Glass Components .....</b>	<b>177</b>
Trim Stops - Art Glass .....	177
Art Glass Hardware .....	177
 <b>Stormwatch® Protection (Coastal Product) .....</b>	 <b>Page 179</b>
 <b>Service Replacement .....</b>	 <b>Page 181</b>
<b>Service Replacement Only Parts .....</b>	<b>181</b>
Service Replacement Only Parts .....	181
Exterior Grilles - High Definition (HDN) .....	181
Interior Grilles - High Definition (HDN) .....	183



# 400 Series Frenchwood® Gliding Doors (1987 to Present)

2-Panel, 4-Panel, and Stationary

## Parts Illustration

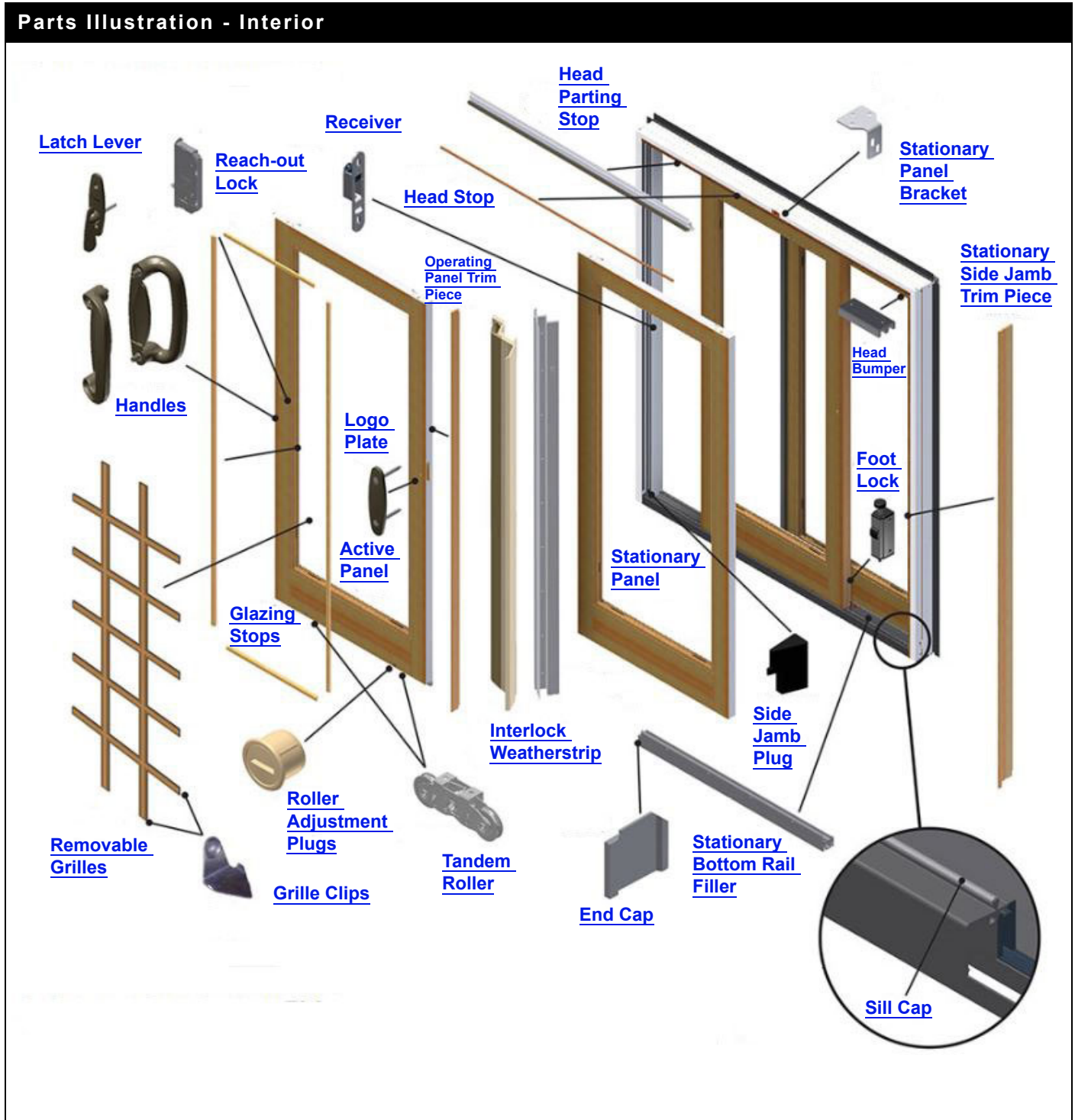

## Parts Illustration

### Parts Illustration - Exterior

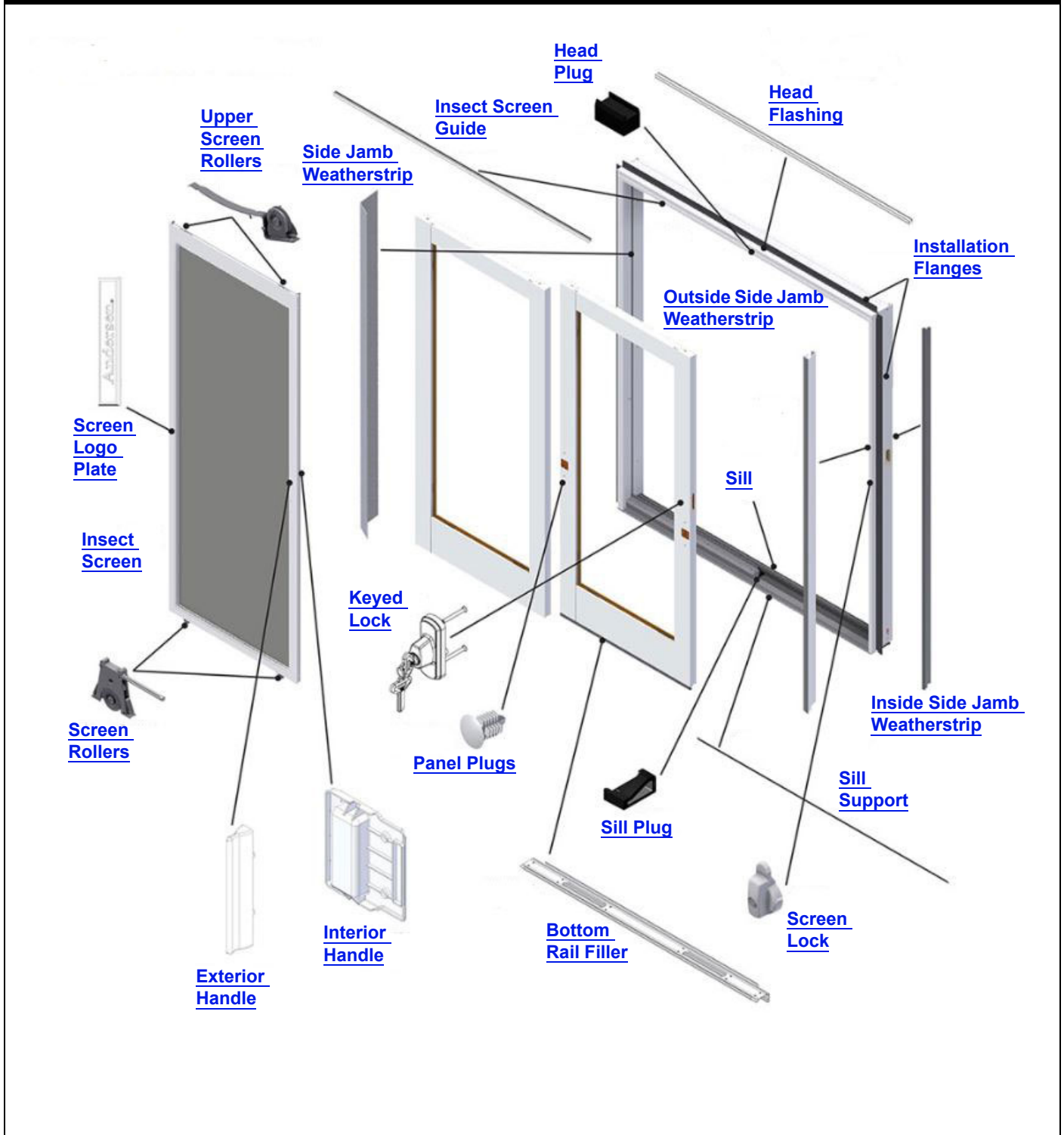

# 400 Series Frenchwood® Gliding Doors (1987 to Present)

2-Panel, 4-Panel, and Stationary

## Parts Illustration

### Parts Illustration - 4-Panel

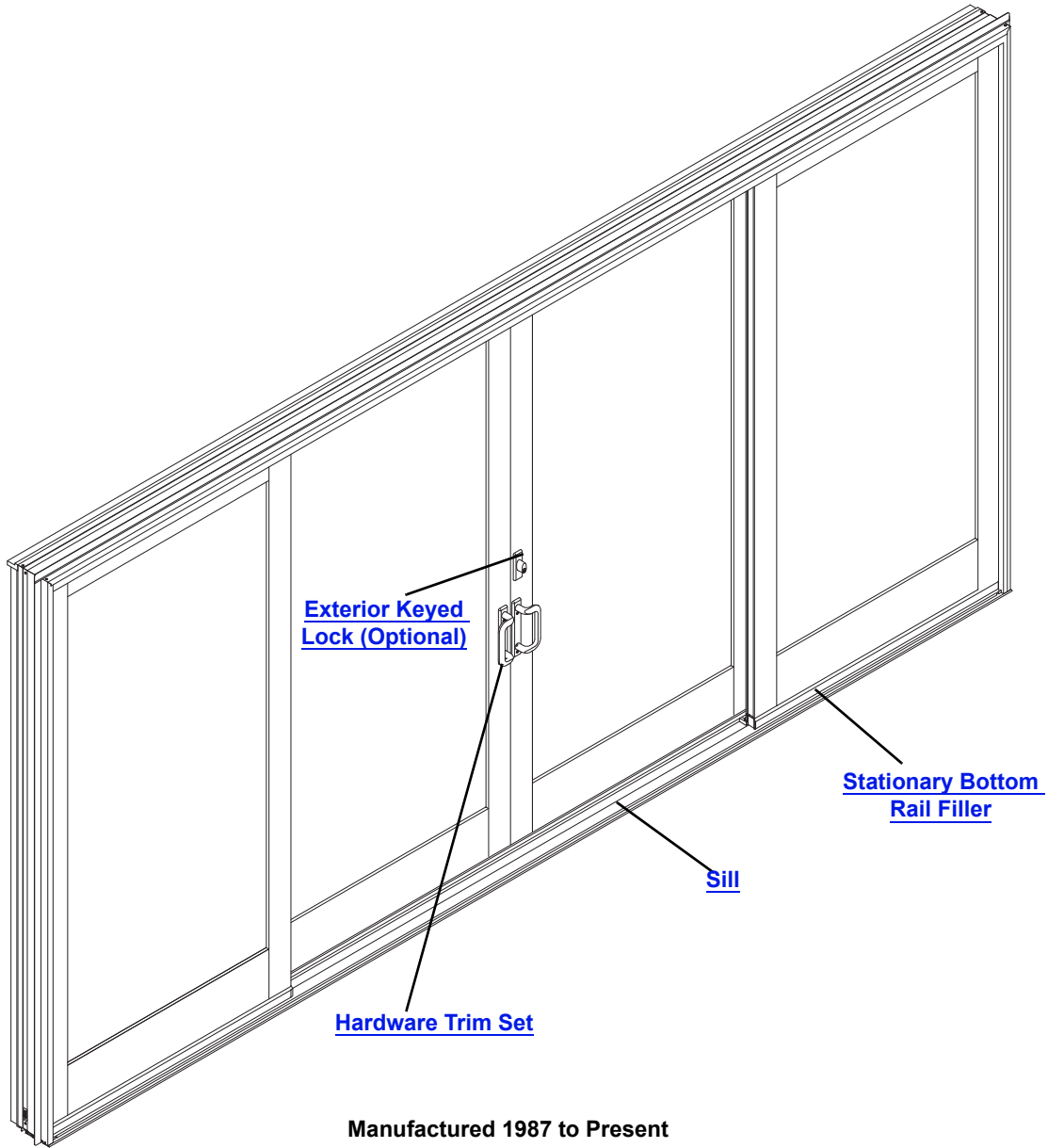

Manufactured 1987 to Present

**Frenchwood® Gliding Unit Parts - 4-Panel**

*Unit viewed from exterior.*

## Parts Illustration

### Parts Illustration - 2-Panel

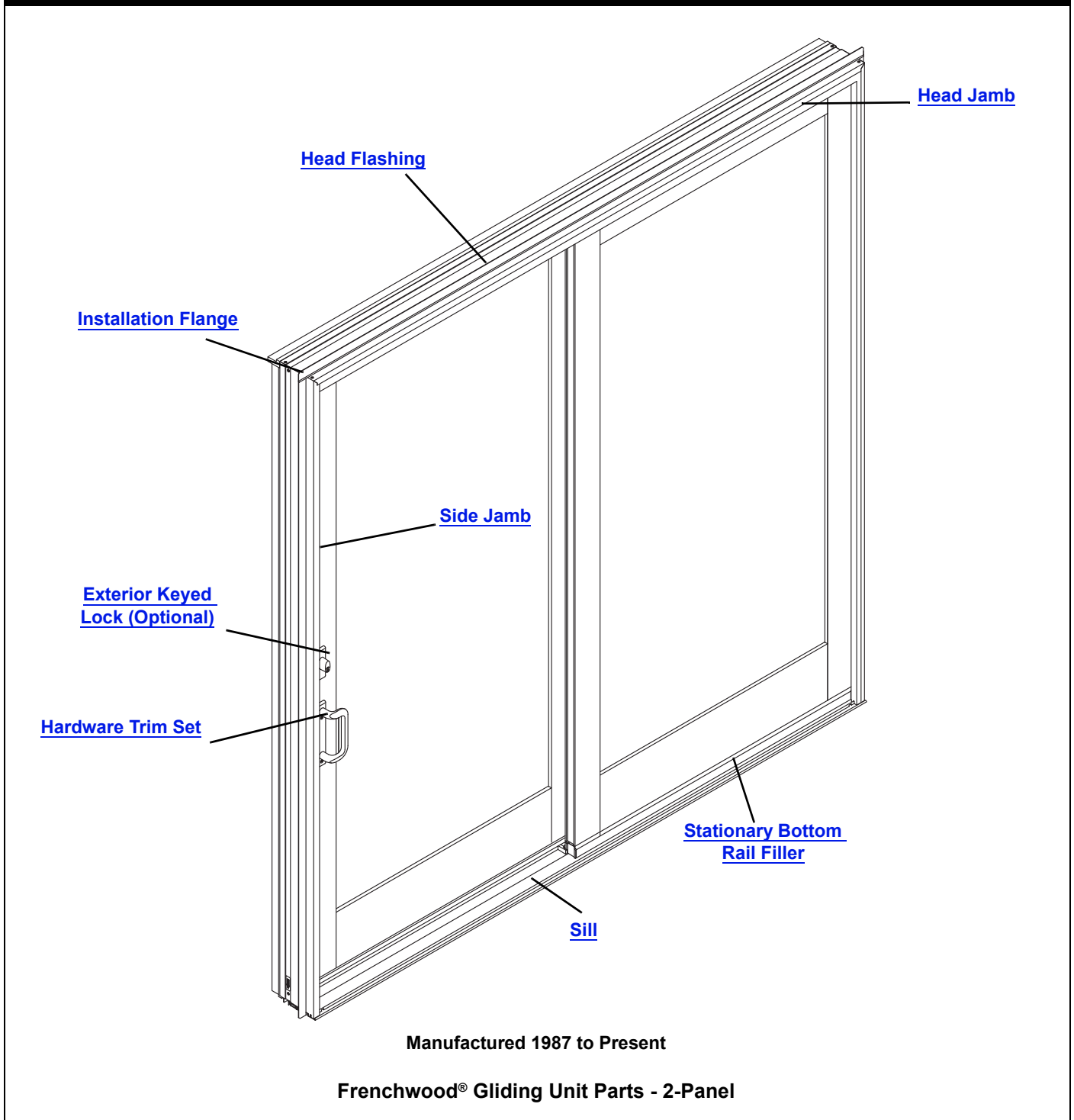

*Unit viewed from exterior.*



# 400 Series Frenchwood® Gliding Doors (1987 to Present)

*2-Panel, 4-Panel, and Stationary*

## Unit Sizes

### Standard and Custom Door Sizes

**Note:**

Frenchwood Gliding Doors are available in standard sizes (see standard size charts, [page 10](#)). Replacement parts for some standard doors can be ordered using the numbers listed in this catalog. Many replacement parts for standard doors are made to order. These items are ordered using the Product ID found on the identification label and a description of the part needed. See [Service Guide 9051877](#).

Frenchwood Gliding Doors are also available in custom sizes in 1/8" increments between the smallest and the largest standard sizes. Most replacement parts for custom-sized doors are made to order and can be ordered with the Product ID found on the identification label and a description of the part needed. See [Service Guide 9051877](#).

### 400 Series Product Label

**Note:**

Every Frenchwood Gliding Door will have an identification label **or** glass etching containing a unique Product ID. The Product ID on Frenchwood Gliding Doors will be located at the top of the door frame or etched into the glass. See [Service Guide 9051877](#). The Product ID may be up to 14 digits long (excluding hyphens), depending on the age of the unit. Replacement parts will also get their own unique Product ID. When ordering replacement parts, providing the Product ID ensures that replacement parts match the specifications.

## Unit Sizes

### Unit Size Chart - 6' 8" Height

**Note:**

Unit Dimension refers to overall outside-to-outside frame. Unobstructed Glass refers to visible glass dimensions. Numbers in parentheses are metric measurements. See [Measuring Visible Glass Video](#). See latest [Product Details](#).

UNOBSTRUCTED GLASS DIMENSION					
	Unit Dimension	2'-8"	4'-11 1/4"	4'-11 1/4"	9'-9"
	Rough Opening	2'-8 3/4"	5'-0"	5'-0"	9'-9 3/4"
	Center Line Meeting Stiles		2'-5 5/8" (752)	2'-5 5/8" (752)	2'-5 1/16" (754) 2'-4 13/16" (732) 2'-4 13/16" (732) 2'-5 1/16" (754)
	FWG 2668	FWG 2968S	FWG 5068 L	FWG 5068R	FWG 10068-4*
UNOBSTRUCTED GLASS DIMENSION					
	Unit Dimension	3'-2"	5'-11 1/4"	5'-11 1/4"	11'-9"
	Rough Opening	3'-2 3/4"	6'-0"	6'-0"	11'-9 3/4"
	Center Line Meeting Stiles		2'-11 5/8" (905)	2'-11 5/8" (905)	2'-11 1/16" (906) 2'-10 13/16" (884) 2'-10 13/16" (884) 2'-11 1/16" (906)
	FWG 3068	FWG 3368S	FWG 6068L	FWG 6068R	FWG 12068-4*
UNOBSTRUCTED GLASS DIMENSION					
	Unit Dimension	4'-2"	7'-11 1/4"	7'-11 1/4"	15'-9"
	Rough Opening	4'-2 3/4"	8'-0"	8'-0"	15'-9 3/4"
	Center Line Meeting Stiles		3'-11 5/8" (1210)	3'-11 5/8" (1210)	3'-11 11/16" (1211) 3'-10 13/16" (1189) 3'-10 13/16" (1189) 3'-11 11/16" (1211)
	FWG 4068	FWG 4368S	FWG 8068 L	FWG 8068R	FWG 16068-4*

Manufactured 1987 to Present

### Frenchwood® Gliding Unit Sizes - 6' 8" Height

Unit viewed from exterior.

# 400 Series Frenchwood® Gliding Doors (1987 to Present)

2-Panel, 4-Panel, and Stationary

## Unit Sizes

### Unit Size Chart - 6' 11" Height

**Note:**

Unit Dimension refers to overall outside-to-outside frame. Unobstructed Glass refers to visible glass dimensions. Numbers in parentheses are metric measurements. See [Measuring Visible Glass Video](#). See latest [Product Details](#).

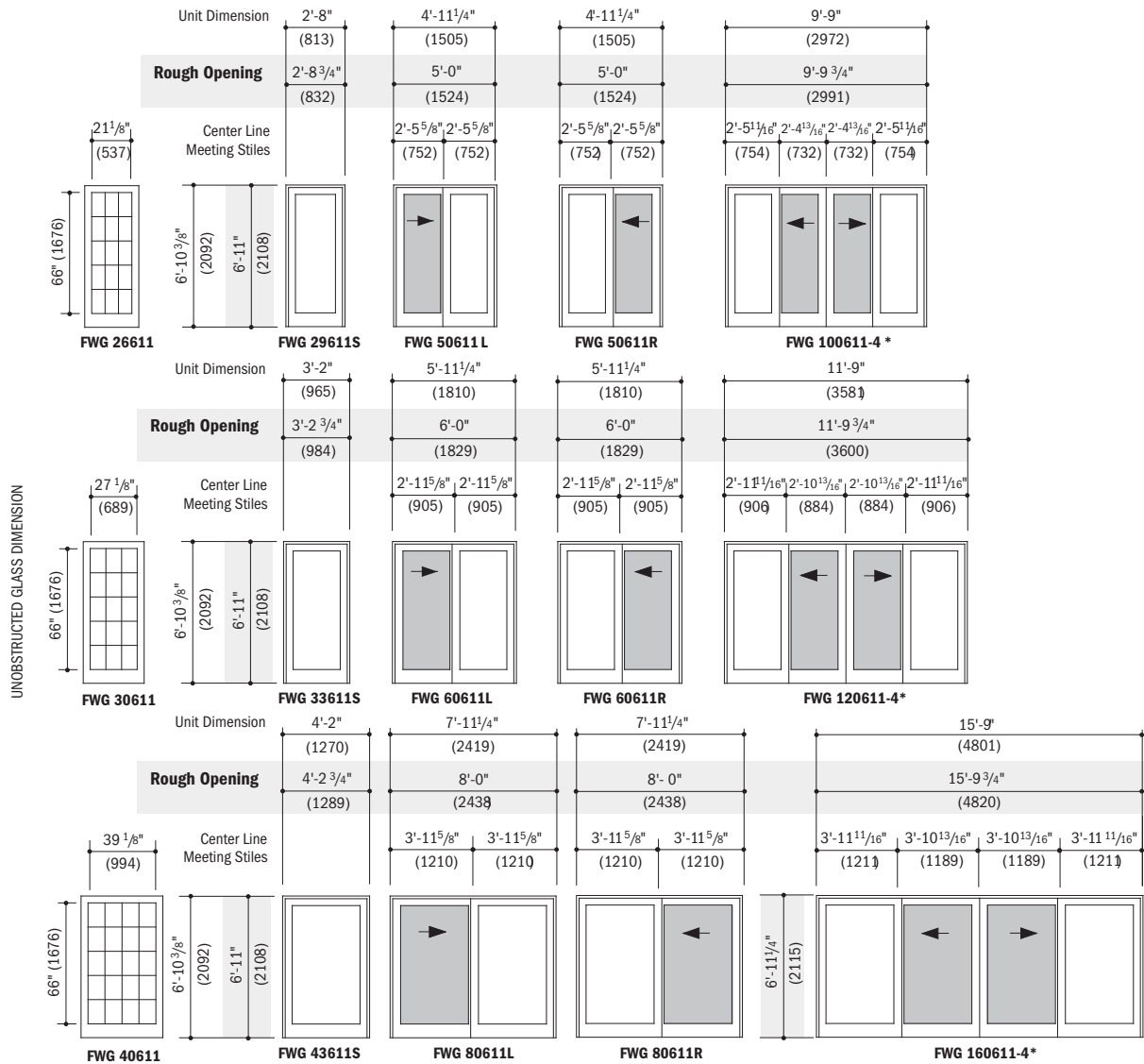

Manufactured 1995 to Present

### Frenchwood® Gliding Unit Sizes - 6' 11" Height

Unit viewed from exterior.

## Unit Sizes

### Unit Size Chart - 8' 0" Height

**Note:**

Unit Dimension refers to overall outside-to-outside frame. Unobstructed Glass refers to visible glass dimensions. Numbers in parentheses are metric measurements. See [Measuring Visible Glass Video](#). See latest [Product Details](#).

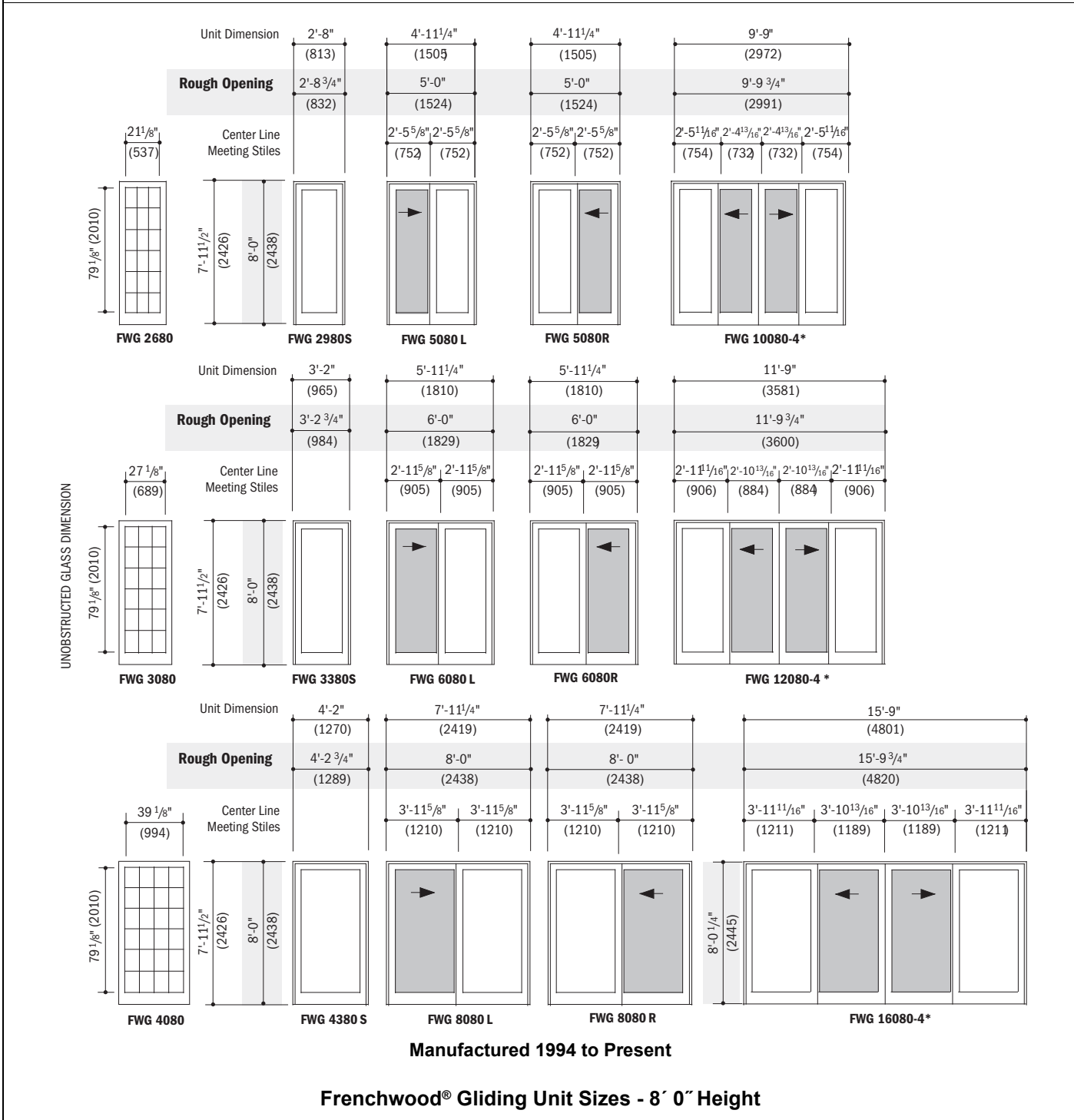

# 400 Series Frenchwood® Gliding Doors (1987 to Present)

2-Panel, 4-Panel, and Stationary

## Unit Sizes

### Panel Handing

#### As Viewed from the Exterior

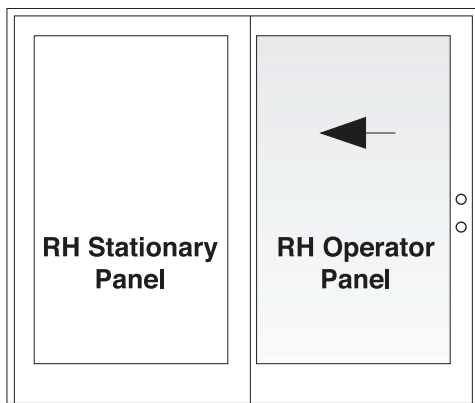

**2-Panel Right Hand (SR)**

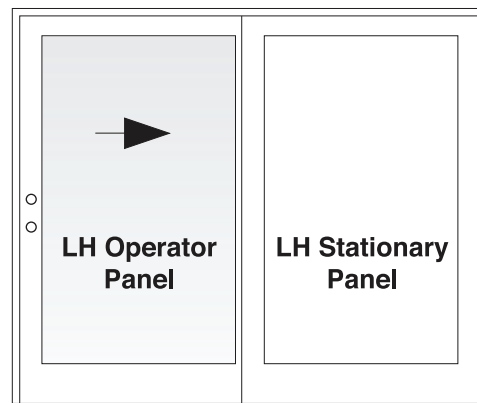

**2-Panel Left Hand (LS)**

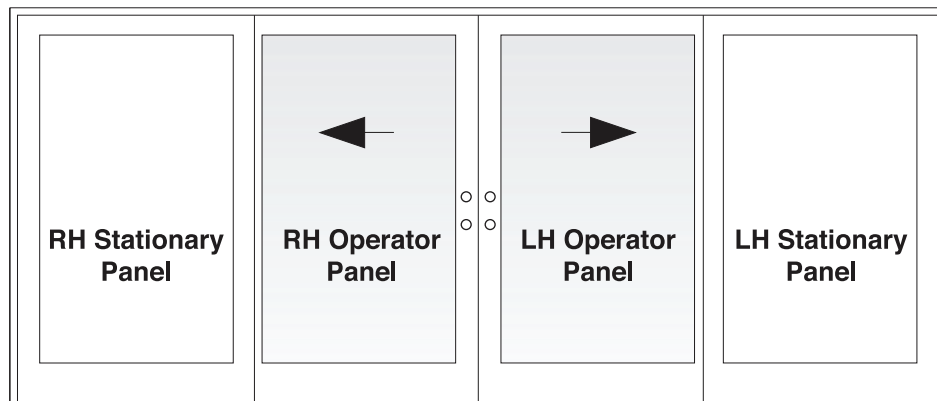

**4-Panel (SRLS)**

## Product History

---

### Product History

- 2022** Interior White finish changed to painted finish. See [Bulletin 14.22](#)
- 2012** Decommission of Andersen® 400 Series Frenchwood® Patio Doors with Stormwatch® Protection.
- 2009** Albany hardware in finishes of White, Stone, Gold Dust and Black introduced.
- 2007** Custom sizes introduced in Product Guide for Professionals. See [Standard and Custom Door Sizes](#).
- 2007** Factory assembled doors introduced.
- 2004** Hardware finishes of Distressed Bronze and Distressed Nickel introduced.
- 2004** Hardware collections with seven hardware styles introduced.
- 2003** Stormwatch® Protection (Coastal Product) with design pressure upgrades, glass options and structural enhancements introduced.
- 2001** Forest Green introduced.
- 2000** PI option (pre-finished inside) for panels and grilles introduced.
- 1999** Maple and Oak interiors introduced.
- 1999** Metro Style hardware (now called Tribeca®) introduced.
- 1998** Estate Style hardware (now called Newbury®) introduced.
- 1995** 6' 11" high size introduced.
- 1991** Sandtone color introduced.
- 1991** 8' high size introduced.
- 1987** Frenchwood® Gliding Doors introduced.

# 400 Series Frenchwood® Gliding Doors (1987 to Present)

2-Panel, 4-Panel, and Stationary

## Panels - Operating

### Operating Panel Graphic

Note:

See latest [Product Details](#).

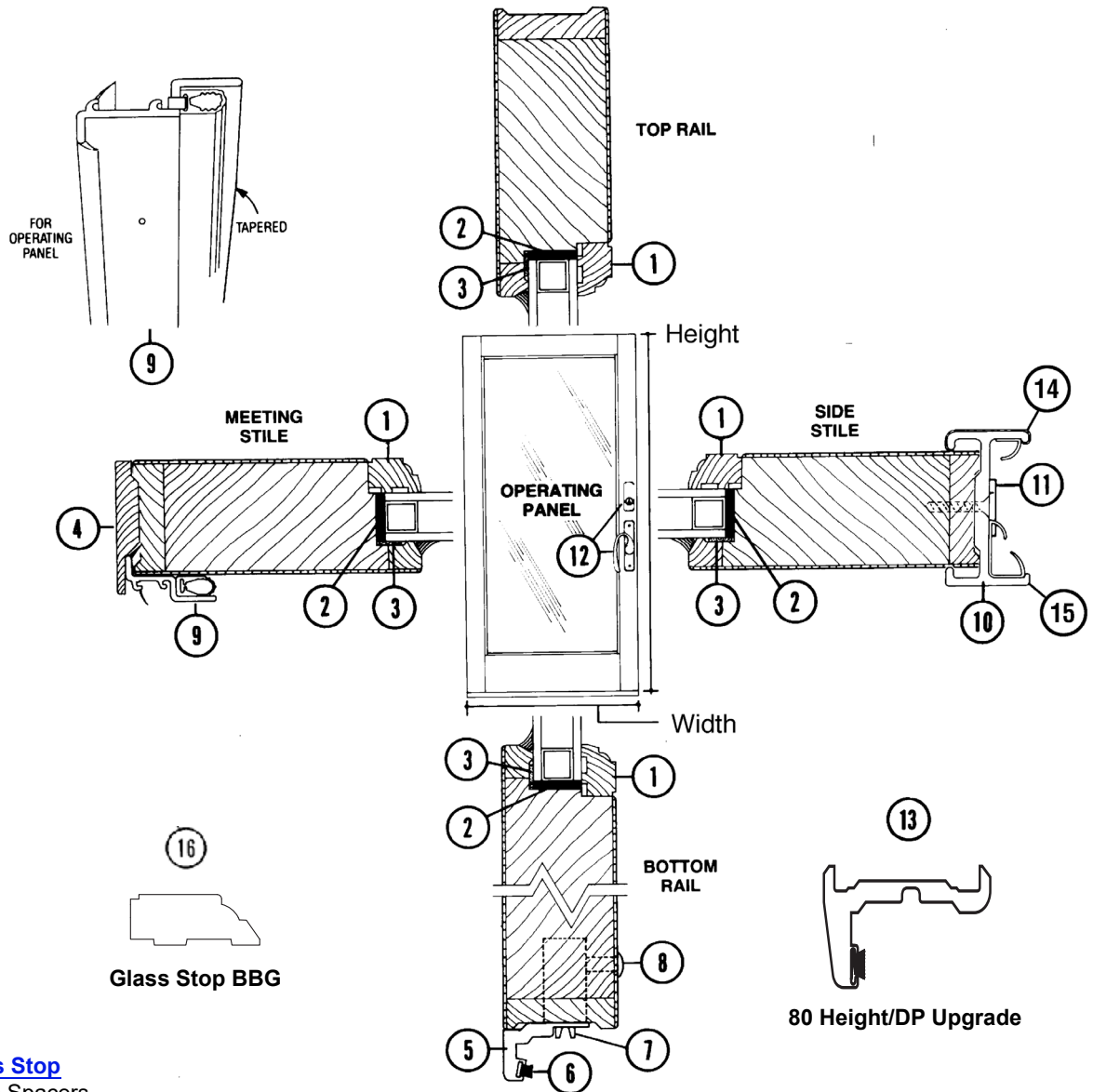

- |  |   |
|--|---|
| <ol style="list-style-type: none"> <li>1. <a href="#">Glass Stop</a></li> <li>2. Glass Spacers</li> <li>3. Silicone Glazing</li> <li>4. <a href="#">Trim Piece Operating Meeting Stile</a></li> <li>5. <a href="#">Operating Bottom Rail Filler with Screws - 68/611 Height</a></li> <li>6. <a href="#">Operating Bottom Rail Filler Finseal Pile W/S</a></li> <li>7. <a href="#">Tandem Roller</a></li> <li>8. <a href="#">Plugs, Adjusting Holes</a></li> <li>9. <a href="#">Interlock W/S, Meeting Stile - Set</a></li> </ol> | <ol style="list-style-type: none"> <li>10. <a href="#">4-panel Door Astragal</a></li> <li>11. <a href="#">Lock Strike Plate with Liner</a></li> <li>12. <a href="#">Hardware Trim Set</a></li> <li>13. <a href="#">Operating Bottom Rail Filler w/Screws - 80 Height/DPU</a></li> <li>14. <a href="#">Inside Astragal Weatherstrip</a></li> <li>15. <a href="#">Outside Astragal Weatherstrip</a></li> <li>16. <a href="#">Glass Stop - Blinds Between the Glass</a></li> </ol> |
|--|---|

### Frenchwood® Gliding Operating Panel - 4-Panel

Unit viewed from exterior.

## Panels - Operating

### Operating Panel Size Table

**Note:**

Operating Panel is measured outside edge to outside edge of frame.

Unobstructed Glass is dimension from outside edge to outside edge of visible glass only.

Actual Glass is dimension of outside edge to outside edge of glass, including glass that is not visible.

1" Finelight™ grille profile is standard, with color matching exterior color of panel. Maple and Oak finishes introduced in 1999.

Pre-finished white introduced in 2000.

Unit No.	Operating Panel	Unobstructed Glass	Actual Glass
<b>FWG2668</b>	30 × 76 <sup>9</sup> / <sub>64</sub>	21 <sup>1</sup> / <sub>8</sub> × 63 <sup>1</sup> / <sub>8</sub>	22 <sup>1</sup> / <sub>4</sub> × 64 <sup>1</sup> / <sub>4</sub>
<b>FWG26611</b>	30 × 79 <sup>1</sup> / <sub>64</sub>	21 <sup>1</sup> / <sub>8</sub> × 66	22 <sup>1</sup> / <sub>4</sub> × 67 <sup>1</sup> / <sub>8</sub>
<b>FWG2680</b>	30 × 92 <sup>9</sup> / <sub>64</sub>	21 <sup>1</sup> / <sub>8</sub> × 79 <sup>1</sup> / <sub>8</sub>	22 <sup>1</sup> / <sub>4</sub> × 80 <sup>1</sup> / <sub>4</sub>
<b>FWG3068</b>	36 × 76 <sup>9</sup> / <sub>64</sub>	27 <sup>1</sup> / <sub>8</sub> × 63 <sup>1</sup> / <sub>8</sub>	28 <sup>1</sup> / <sub>4</sub> × 64 <sup>1</sup> / <sub>4</sub>
<b>FWG30611</b>	36 × 79 <sup>1</sup> / <sub>64</sub>	27 <sup>1</sup> / <sub>8</sub> × 66	28 <sup>1</sup> / <sub>4</sub> × 67 <sup>1</sup> / <sub>8</sub>
<b>FWG3080</b>	36 × 92 <sup>9</sup> / <sub>64</sub>	27 <sup>1</sup> / <sub>8</sub> × 79 <sup>1</sup> / <sub>8</sub>	28 <sup>1</sup> / <sub>4</sub> × 80 <sup>1</sup> / <sub>4</sub>
<b>FWG4068</b>	48 × 76 <sup>9</sup> / <sub>64</sub>	39 <sup>1</sup> / <sub>8</sub> × 63 <sup>1</sup> / <sub>8</sub>	40 <sup>1</sup> / <sub>4</sub> × 64 <sup>1</sup> / <sub>4</sub>
<b>FWG40611</b>	48 × 79 <sup>1</sup> / <sub>64</sub>	39 <sup>1</sup> / <sub>8</sub> × 66	40 <sup>1</sup> / <sub>4</sub> × 67 <sup>1</sup> / <sub>8</sub>
<b>FWG4080</b>	48 × 92 <sup>9</sup> / <sub>64</sub>	39 <sup>1</sup> / <sub>8</sub> × 79 <sup>1</sup> / <sub>8</sub>	40 <sup>1</sup> / <sub>4</sub> × 80 <sup>1</sup> / <sub>4</sub>

### Operating Panels

**Note:**

See [Panel Replacement Video](#). Assembled operating panel includes [tandem rollers](#), [rail filler](#) and ships with [operating panel trim piece](#). When replacing gliding door panels it is recommended to also replace the [interlock weatherstrip](#). Operating panels for custom sized doors are made to order. Product ID label is located on top edge of operating panel. See iQ+ for additional glazing types available by description/configured.

To order, state:

1. Description of part (Operating Panel)
2. Handing (RH or LH)
3. Quantity
4. Product ID (from product label, see [Service Guide 9051877](#))
5. Options Desired (if different than original product)



# 400 Series Frenchwood® Gliding Doors (1987 to Present)

2-Panel, 4-Panel, and Stationary

## Panels - Operating

### Operating Panel / High Performance Tempered Blinds Between Glass w/Tube

**Note:**

Handed as unit is handed. See iQ images below for 2-Panel detail (68 height shown). WH/PN and WH/WH first offered in October of 2015.

Qty	Part Number	Description
1	2565012	FWG6068SR, Frame, SR Handing, White/Clear Pine
1	9164463	FWG3068, Right Stationary Panel, White/Clear Pine, High Performance Low-E4 Tempered Blinds Between the Glass with Tubes
1	9164461	FWG3068, Right Operating Panel, White/Clear Pine, High Performance Low-E4 Tempered Blinds Between the Glass with Tubes

Qty	Part Number	Description
1	2565010	FWG6068LS, Frame, LS Handing, White/Clear Pine
1	9164464	FWG3068, Left Stationary Panel, White/Clear Pine, High Performance Low-E4 Tempered Blinds Between the Glass with Tubes
1	9164462	FWG3068, Left Operating Panel, White/Clear Pine, High Performance Low-E4 Tempered Blinds Between the Glass with Tubes

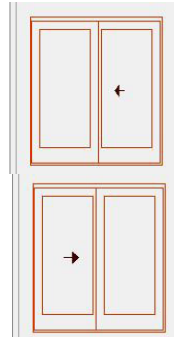

### Operating Panel / High Performance Tempered BBG w/Tube / Pine Interior (May 2019 to Present)

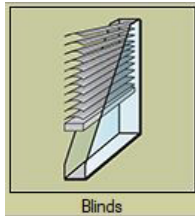

Blinds

Unit No.		Exterior							
		White		Terratone®		Sandtone		Forest Green	
Unit No.		Interior							
		PINE							
		Left	Right	Left	Right	Left	Right	Left	Right
<b>30</b>	<b>FWG3068</b>	9164462	9164461	9179040	9179039	9179056	9179055	9179072	9179071
	<b>FWG30611</b>	9164474	9164473	9179048	9179047	9179064	9179063	9179080	9179079

### Operating Panel / High Performance Tempered BBG w/Tube / White Interior (October 2015 to Present)

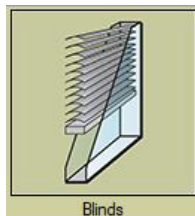

Blinds

Unit No.		Exterior							
		White		Terratone®		Sandtone		Forest Green	
Unit No.		Interior							
		White							
		Left	Right	Left	Right	Left	Right	Left	Right
<b>30</b>	<b>FWG3068</b>	9164458	9164457	9179036	9179035	9179052	9179051	9179068	9179067
	<b>FWG30611</b>	9164470	9164469	9179044	9179043	9179060	9179059	9179076	9179075

## Panels - Operating

### Operating Panel / High Performance Low-E4® Tempered

Panel - Operating / High-Performance-Low-E4® Tempered / Pine Interior					
Unit No.		Exterior			
		White	Terratone®	Sandtone	Forest Green
		Interior			
		PINE			
26	FWG2668	2565904	2651004	0911002	1262340
	FWG26611	2565902	2651002	0911003	1262138
	FWG2680	2565924	2651024	0911022	1262140
30	FWG3068	2565908	2651008	0911006	1262144
	FWG30611	2565917	2651017	0911015	1262146
	FWG3080	2565928	2651028	0911026	1262148
40	FWG4068	2565912	2651012	0911010	1262150
	FWG40611	2565919	2651019	0911017	1262152
	FWG4080	2565932	2651032	0911030	1262154

Panel - Operating / High-Performance-Low-E4® Tempered / Maple Interior					
Unit No.		Exterior			
		White	Terratone®	Sandtone	Forest Green
		Interior			
		MAPLE			
26	FWG2668	2566237	2651069	0910973	By description
	FWG26611	2566235	2651077	0910974	By description
	FWG2680	2566249	2651083	By description	By description
30	FWG3068	2566239	2651073	0910977	1262162
	FWG30611	2566245	2651079	0910983	1262164
	FWG3080	2566251	2651085	0910989	1262166
40	FWG4068	2566241	2651075	0910979	1262168
	FWG40611	2566247	2651081	0910985	1262170
	FWG4080	2566253	2651087	0910991	1262172

Panel - Operating / High-Performance-Low-E4® Tempered / Oak Interior					
Unit No.		Exterior			
		White	Terratone®	Sandtone	Forest Green
		Interior			
		OAK			
26	FWG2668	2566217	2651049	0910947	1262174
	FWG26611	2566215	2651057	0910948	1262176
	FWG2680	2566229	2651063	0910961	1262178
30	FWG3068	2566219	2651053	0910951	1262180
	FWG30611	2566225	2651059	0910957	1262182
	FWG3080	2566231	2651065	0910963	1262184
40	FWG4068	2566221	2651055	0910953	1262186
	FWG40611	2566227	2651061	0910959	1262188
	FWG4080	2566233	2651067	0910965	1262190

## 400 Series Frenchwood® Gliding Doors (1987 to Present)

*2-Panel, 4-Panel, and Stationary*

### Panels - Operating

Panel - Operating / High-Performance-Low-E4® Tempered / Interior White		
Unit No.		Exterior
		White
		Interior
		White
<b>26</b>	FWG2668	2566201
	FWG26611	2566257
	FWG2680	2566259
<b>30</b>	FWG3068	2566263
	FWG30611	2566261
	FWG3080	2566265
<b>40</b>	FWG4068	2566269
	FWG40611	2566267
	FWG4080	2566271

## Panels - Operating

### Operating Panel / High Performance Low-E4® Smart Sun Tempered

Panel - Operating / High-Performance-Low-E4® Tempered / Smart Sun / Tempered / Pine Interior					
Unit No.		Exterior			
		White	Terratone®	Sandtone	Forest Green
		Interior			
		PINE			
<b>26</b>	<b>FWG2668</b>	By description	By description	By description	By description
	<b>FWG26611</b>	By description	By description	By description	By description
	<b>FWG2680</b>	By description	By description	By description	By description
<b>30</b>	<b>FWG3068</b>	9021468	9021401	9021400	By description
	<b>FWG30611</b>	By description	By description	By description	By description
	<b>FWG3080</b>	By description	By description	By description	By description
<b>40</b>	<b>FWG4068</b>	9021470	9021405	9021404	By description
	<b>FWG40611</b>	By description	By description	By description	By description
	<b>FWG4080</b>	By description	By description	By description	By description

# 400 Series Frenchwood® Gliding Doors (1987 to Present)

2-Panel, 4-Panel, and Stationary

## Panels - Operating

### Operating Panel / High Performance Low-E4® Sun Tempered

Panel - Operating / High-Performance-Low-E4® Sun Tempered / Pine Interior					
Unit No.		Exterior			
		White	Terratone®	Sandtone	Forest Green
		Interior PINE			
26	FWG2668	2566004	2651204	0911102	By description
	FWG26611	2566002	2651202	0911103	By description
	FWG2680	2566034	2651224	0911122	By description
30	FWG3068	2566018	2651208	0911106	By description
	FWG30611	2566027	2651217	0911115	By description
	FWG3080	2566038	2651228	0911126	By description
40	FWG4068	2566022	2651212	0911110	By description
	FWG40611	2566029	2651219	0911117	By description
	FWG4080	2566042	2651232	0911130	By description

Panel - Operating / High-Performance-Low-E4® Sun Tempered / Maple Interior					
Unit No.		Exterior			
		White	Terratone®	Sandtone	Forest Green
		Interior MAPLE			
26	FWG2668	2566067	2651280	0911141	By description
	FWG26611	2566065	2651261	0911142	By description
	FWG2680	2566079	2651274	0911155	By description
30	FWG3068	2566069	2651264	0911145	By description
	FWG30611	2566075	2651270	0911151	By description
	FWG3080	2566081	2651276	0911157	By description
40	FWG4068	2566071	2651266	0911147	By description
	FWG40611	2566077	2651272	0911153	By description
	FWG4080	2566083	2651278	0911159	By description

Panel - Operating / High-Performance-Low-E4® Sun Tempered / Oak Interior					
Unit No.		Exterior			
		White	Terratone®	Sandtone	Forest Green
		Interior OAK			
26	FWG2668	2566047	2651254	0911101	By description
	FWG26611	2566045	2651235	0911107	By description
	FWG2680	2566059	2651248	0911135	By description
30	FWG3068	2566049	2651238	0911119	By description
	FWG30611	2566055	2651244	0911129	By description
	FWG3080	2566061	2651250	0911137	By description
40	FWG4068	2566051	2651240	0911121	By description
	FWG40611	2566057	2651246	0911133	By description
	FWG4080	2566063	2651252	0911139	By description

## Panels - Operating

Panel - Operating / High-Performance-Low-E4® Sun Tempered / Interior White		
		Exterior
		White
		Interior
		White
Unit No.		
<b>26</b>	FWG2668	2566291
	FWG26611	2566293
	FWG2680	2566295
<b>30</b>	FWG3068	2566299
	FWG30611	2566297
	FWG3080	2566302
<b>40</b>	FWG4068	2566306
	FWG40611	2566304
	FWG4080	2566309

### Operating Panel / High Performance Sun II Tempered

**Panel - Operating / High-Performance Sun II Tempered / Pine Interior**

**Note:**  
Available by description. Order handle hole plugs (page 34) separately.

**Panel - Operating / High-Performance Sun II Tempered / Maple Interior**

**Note:**  
Available by description. Order handle hole plugs (page 34) separately.

**Panel - Operating / High-Performance Sun II Tempered / Oak Interior**

**Note:**  
Available by description. Order handle hole plugs (page 34) separately.

**Panel - Operating / High-Performance Sun II Tempered / Interior White**

**Note:**  
Available by description. Order handle hole plugs (page 34) separately.

# 400 Series Frenchwood® Gliding Doors (1987 to Present)

*2-Panel, 4-Panel, and Stationary*

## Panels - Operating

### Operating Panel / High Performance Low-E4® Tempered Finelight™

Panel - Operating / High-Performance-Low-E4® Tempered Finelight™ / Pine Interior					
Unit No.		Exterior			
		White	Terratone®	Sandtone	Forest Green
		Interior			
		PINE			
<b>26</b>	FWG2668	2566101	By description	0911173	By description
	FWG26611	2566107	By description	0911179	By description
	FWG2680	2566113	By description	0911185	By description
<b>30</b>	FWG3068	2566103	2651117	0911175	By description
	FWG30611	2566109	By description	0911181	By description
	FWG3080	2566115	By description	0911187	By description
<b>40</b>	FWG4068	2566105	2651119	0911177	By description
	FWG40611	2566111	By description	0911183	By description
	FWG4080	2566117	By description	0911189	By description

Panel - Operating / High-Performance-Low-E4® Tempered Finelight™ / Maple Interior					
Unit No.		Exterior			
		White	Terratone®	Sandtone	Forest Green
		Interior			
		MAPLE			
<b>26</b>	FWG2668	By description	By description	By description	By description
	FWG26611	By description	By description	By description	By description
	FWG2680	By description	By description	By description	By description
<b>30</b>	FWG3068	2566139	By description	By description	By description
	FWG30611	By description	By description	By description	By description
	FWG3080	By description	By description	By description	By description
<b>40</b>	FWG4068	By description	By description	By description	By description
	FWG40611	By description	By description	By description	By description
	FWG4080	By description	By description	By description	By description

Panel - Operating / High-Performance-Low-E4® Tempered Finelight™ / Oak Interior					
Unit No.		Exterior			
		White	Terratone®	Sandtone	Forest Green
		Interior			
		OAK			
<b>26</b>	FWG2668	2566119	By description	By description	By description
	FWG26611	By description	By description	By description	By description
	FWG2680	By description	By description	By description	By description
<b>30</b>	FWG3068	2566121	By description	0911193	By description
	FWG30611	2566127	By description	0911199	By description
	FWG3080	By description	By description	By description	By description
<b>40</b>	FWG4068	2566123	By description	By description	By description
	FWG40611	By description	By description	By description	By description
	FWG4080	By description	By description	By description	By description

## Panels - Operating

Panel - Operating / High-Performance-Low-E4 <sup>®</sup> Tempered Finelight <sup>™</sup> / Interior White		
		<b>Exterior</b>
		<b>White</b>
		<b>Interior</b>
	<b>Unit No.</b>	<b>White</b>
<b>26</b>	<b>FWG2668</b>	2566275
	<b>FWG26611</b>	2566273
	<b>FWG2680</b>	2566277
<b>30</b>	<b>FWG3068</b>	2566281
	<b>FWG30611</b>	2566279
	<b>FWG3080</b>	2566283
<b>40</b>	<b>FWG4068</b>	2566287
	<b>FWG40611</b>	2566285
	<b>FWG4080</b>	2566289



# 400 Series Frenchwood® Gliding Doors (1987 to Present)

2-Panel, 4-Panel, and Stationary

## Panels - Operating

### Operating Panel / Stormwatch®

**Note:**

Impact resistant High-Performance Sun II Tempered, Gray Laminated Monolithic panels, and Clear Laminated Monolithic panels are available by description.

### Panel - Operating / High-Performance-Low-E4® Tempered (Impact Resistant) / Pine Interior

Unit No.	Exterior			
	White	Terratone®	Sandtone	Forest Green
	Interior PINE			
FWG2668	By description	By description	By description	By description
FWG26611	By description	By description	By description	By description
FWG2680	By description	By description	By description	By description
FWG3068	2560522	By description	By description	By description
FWG30611	2560524	By description	By description	By description
FWG3080	2560526	By description	0910512	By description
FWG4068	2560528	By description	By description	By description
FWG40611	2560530	By description	By description	By description
FWG4080	2560532	By description	By description	By description

### Panel - Operating / High-Performance-Low-E4® Tempered (Impact Resistant) / Maple Interior

Unit No.	Exterior			
	White	Terratone®	Sandtone	Forest Green
	Interior MAPLE			
FWG2668	By description	By description	By description	By description
FWG26611	By description	By description	By description	By description
FWG2680	By description	By description	By description	By description
FWG3068	By description	By description	By description	By description
FWG30611	By description	By description	By description	By description
FWG3080	By description	By description	By description	By description
FWG4068	By description	By description	By description	By description
FWG40611	By description	By description	By description	By description
FWG4080	By description	By description	By description	By description

## Panels - Operating

Panel - Operating / High-Performance-Low-E4® Tempered (Impact Resistant) / Oak Interior					
	Unit No.	Exterior			
		White	Terratone®	Sandtone	Forest Green
		Interior			
					
	FWG2668	By description	By description	By description	By description
	FWG26611	By description	By description	By description	By description
	FWG2680	By description	By description	By description	By description
	FWG3068	By description	By description	By description	By description
	FWG30611	By description	By description	By description	By description
	FWG3080	By description	By description	By description	By description
FWG4068	By description	By description	By description	By description	
FWG40611	By description	By description	By description	By description	
FWG4080	By description	By description	By description	By description	

Panel - Operating / High-Performance-Low-E4® Tempered (Impact Resistant) / Interior White		
	Unit No.	Exterior/Interior
		White
	FWG2668	2560533
	FWG26611	By description
	FWG2680	By description
	FWG3068	2560539
	FWG30611	2560541
	FWG3080	2560543
	FWG4068	By description
	FWG40611	By description
FWG4080	By description	

Panel - Operating / High-Performance-Low-E4® Sun 3 Tempered (Impact Resistant) / Pine Interior					
	Unit No.	Exterior			
		White	Terratone®	Sandtone	Forest Green
		Interior			
					
	FWG2668	By description	By description	By description	By description
	FWG26611	By description	By description	By description	By description
	FWG2680	By description	By description	By description	By description
	FWG3068	By description	By description	By description	By description
	FWG30611	By description	By description	By description	By description
	FWG3080	By description	By description	By description	By description
FWG4068	By description	By description	By description	By description	
FWG40611	By description	By description	By description	By description	
FWG4080	By description	By description	0910536	By description	

# 400 Series Frenchwood® Gliding Doors (1987 to Present)

2-Panel, 4-Panel, and Stationary

## Panels - Operating

Panel - Operating / High-Performance-Low-E4® Sun 3 Tempered (Impact Resistant) / Maple Interior					
	Unit No.	Exterior			
		White	Terratone®	Sandtone	Forest Green
		Interior MAPLE			
	FWG2668	By description	By description	By description	By description
	FWG26611	By description	By description	By description	By description
	FWG2680	By description	By description	By description	By description
	FWG3068	By description	By description	By description	By description
	FWG30611	By description	By description	By description	By description
	FWG3080	By description	By description	By description	By description
	FWG4068	By description	By description	By description	By description
FWG40611	By description	By description	By description	By description	
FWG4080	By description	By description	By description	By description	
Panel - Operating / High-Performance-Low-E4® Sun 3 Tempered (Impact Resistant) / Oak Interior					
	Unit No.	Exterior			
		White	Terratone®	Sandtone	Forest Green
		Interior OAK			
	FWG2668	By description	By description	By description	By description
	FWG26611	By description	By description	By description	By description
	FWG2680	By description	By description	By description	By description
	FWG3068	By description	By description	By description	By description
	FWG30611	By description	By description	By description	By description
	FWG3080	By description	By description	By description	By description
	FWG4068	By description	By description	By description	By description
FWG40611	By description	By description	By description	By description	
FWG4080	By description	By description	By description	By description	
Panel - Operating / High-Performance-Low-E4® Sun 3 Tempered (Impact Resistant) / Interior White					
	Unit No.	Exterior/Interior			
		White			
	FWG2668	By description			
	FWG26611	By description			
	FWG2680	By description			
	FWG3068	By description			
	FWG30611	By description			
	FWG3080	By description			
	FWG4068	By description			
	FWG40611	By description			
FWG4080	By description				

## Panels - Operating

<b>Operating Panel / DP Upgrade</b>				
<b>Panel - Operating / HP Sun Tempered (DP Upgrade) / Pine</b>				
	<b>Unit No.</b>	<b>Exterior</b>		
		<b>White</b>	<b>Terratone®</b>	<b>Sandtone</b>
		<b>Interior</b>		
		<b>PINE</b>		
	<b>FWG2668</b>	By description	By description	0911088
	<b>FWG26611</b>	2565994	By description	By description
	<b>FWG2680</b>	By description	By description	By description
	<b>FWG3068</b>	2565990	2651090	0911090
	<b>FWG30611</b>	2565996	2651096	By description
	<b>FWG3080</b>	By description	By description	By description
<b>FWG4068</b>	2565992	2651092	By description	
<b>FWG40611</b>	By description	By description	By description	
<b>FWG4080</b>	By description	By description	By description	

<b>Panel - Operating / HP Sun Tempered (DP Upgrade) / Maple</b>				
	<b>Unit No.</b>	<b>Exterior</b>		
		<b>White</b>	<b>Terratone®</b>	<b>Sandtone</b>
		<b>Interior</b>		
		<b>MAPLE</b>		
	<b>FWG2668</b>	By description	By description	By description
	<b>FWG26611</b>	By description	By description	By description
	<b>FWG2680</b>	By description	By description	By description
	<b>FWG3068</b>	2565968	By description	By description
	<b>FWG30611</b>	By description	By description	By description
	<b>FWG3080</b>	By description	By description	By description
<b>FWG4068</b>	By description	By description	By description	
<b>FWG40611</b>	By description	By description	By description	
<b>FWG4080</b>	By description	By description	By description	

# 400 Series Frenchwood® Gliding Doors (1987 to Present)

2-Panel, 4-Panel, and Stationary

## Panels - Operating

### Reachout Lock Astragal - Operating - 4-Panel

**Note:**

Astragal may need to be modified when replacing astragals manufactured prior to 2007. See [Accessory Guide 0005197](#), step 9. Reachout astragals for custom sized 4-panel doors are made to order. Product ID label is located on top edge of operating panel.

To order, state:

1. Description of part (Reachout Astragal with Screws)
2. Quantity
3. Product ID (from product label, see [Service Guide 9051877](#))

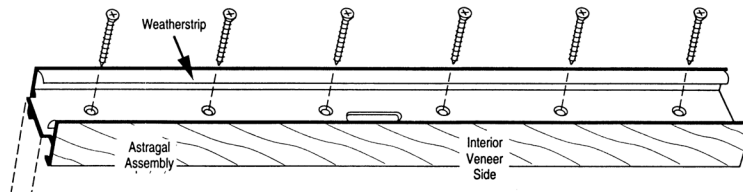

### Reachout Lock Astragal with Screws - Operating / 4-Panel / Pine Interior Ref. No. 10 [page 15](#)

Unit No.	Exterior			
	White	Terratone®	Sandtone	Forest Green
	Interior PINE			
FWG68	2573204	2653817	0910404	1262701
FWG611	2573207	2653811	0910406	1262702
FWG80	2573205	2653818	0910405	1262703

### Reachout Lock Astragal with Screws - Operating / 4-Panel / Maple Interior

Unit No.	Exterior			
	White	Terratone®	Sandtone	Forest Green
	Interior MAPLE			
FWG68	2573211	2653802	0910410	1262707
FWG611	2573213	2653807	0910411	1262708
FWG80	2573217	2653809	0910412	1262709

### Reachout Lock Astragal with Screws - Operating / 4-Panel / Oak Interior

Unit No.	Exterior			
	White	Terratone®	Sandtone	Forest Green
	Interior OAK			
FWG68	2573201	2653798	0910407	1262704
FWG611	2573202	2653799	0910408	1262705
FWG80	2573203	2653801	0910409	1262706

### Reachout Lock Astragal with Screws - Operating / 4-Panel / Interior White

Unit No.	Exterior/Interior
FWG68	2572998
FWG611	2572997
FWG80	2572999

## Panels - Operating

<b>Weatherstrip - Astragal / Inside</b> Ref. No. 14 <a href="#">page 15</a>			
	<b>Color</b>	<b>Size</b>	<b>Order No.</b>
	Gray	68/811/80	2641422
	White		2572919
	Sandtone		0913027

<b>Weatherstrip - Astragal / Outside</b> Ref. No. 15 <a href="#">page 15</a>			
	<b>Color</b>	<b>Size</b>	<b>Order No.</b>
	Gray	68/811/80	2641424
	White		2572932
	Terratone		2653845

<b>Screw - Panel Astragal</b>		
<b>Note:</b> Part number is a quantity of one. Six used per astragal.	<b>Color</b>	<b>Order No.</b>
	White	2500705
	Terratone®	2653863
	Sandtone	0904111
	Forest Green	1269109
	Canvas	9002316
	Dark Bronze	9021238
Black	9002318	

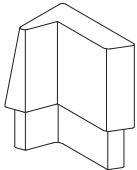
<b>Foam Plug - Astragal / Head</b>		
		<b>Black</b>
		2573212

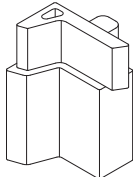
<b>Foam Plug - Astragal / Sill</b>		
		<b>Black</b>
		2573214

# 400 Series Frenchwood® Gliding Doors (1987 to Present)

2-Panel, 4-Panel, and Stationary

## Panels - Operating

### Glass Stops - Operating

**Note:**

When replacing white painted stops with PVC stops, all 4 sides must be replaced. Glass Stops for custom sized doors are made to order. Product ID label is located on top edge of operating panel.

To order, state:

1. Description of part (Glass Stop, Rail or Stile)
2. Quantity
3. Product ID (from product label, see [Service Guide 9051877](#))

### Glass Stop - Rail Ref. No. 1 [page 36](#)



Unit No.	Length	Pine	Maple	Oak	White	Terratone
<b>FWG26</b>	<b>21</b> <sup>17</sup> / <sub>32</sub>	2572812	2572829	2572825	2572347	By description
<b>FWG30</b>	<b>27</b> <sup>17</sup> / <sub>32</sub>	2572816	2572836	2572833	2572348	By description
<b>FWG40</b>	<b>39</b> <sup>17</sup> / <sub>32</sub>	2572818	2572837	2572834	2572349	By description

Unit No.	Length	Sandtone	Canvas	Dark Bronze	Black
<b>FWG26</b>	<b>21</b> <sup>17</sup> / <sub>32</sub>	By description	By description	By description	By description
<b>FWG30</b>	<b>27</b> <sup>17</sup> / <sub>32</sub>	By description	By description	By description	By description
<b>FWG40</b>	<b>39</b> <sup>17</sup> / <sub>32</sub>	By description	By description	By description	By description

### Glass Stop - Stile Ref. No. 1 [page 36](#)

Unit No.	Length	Pine	Maple	Oak	White	Terratone
<b>FWG68</b>	<b>64</b> <sup>55</sup> / <sub>64</sub>	2572820	2572838	2572835	2572350	By description
<b>FWG611</b>	<b>67</b> <sup>47</sup> / <sub>64</sub>	2572824	2572832	2572828	2572351	By description
<b>FWG80</b>	<b>80</b> <sup>55</sup> / <sub>64</sub>	2572822	2572830	2572826	2572352	By description

Unit No.	Length	Sandtone	Canvas	Dark Bronze	Black
<b>FWG68</b>	<b>64</b> <sup>55</sup> / <sub>64</sub>	By description	By description	By description	By description
<b>FWG611</b>	<b>67</b> <sup>47</sup> / <sub>64</sub>	By description	By description	By description	By description
<b>FWG80</b>	<b>80</b> <sup>55</sup> / <sub>64</sub>	By description	By description	By description	By description

## Panels - Operating

### Glass Stop - Rail / 1" Ref. No. 16 [page 15](#)

**Note:**  
One inch glass stops used with triple pane glass and BBG.



Unit No.	Length	Pine	Maple	Oak	White	Terratone
FWG26	21 <sup>17</sup> / <sub>32</sub>	By description	By description	By description	By description	By description
FWG30	27 <sup>17</sup> / <sub>32</sub>	9168010	By description	By description	By description	By description
FWG40	39 <sup>17</sup> / <sub>32</sub>	9205384	9205386	9205385	9205387	9205392

Unit No.	Length	Sandtone	Canvas	Dark Bronze	Black
FWG26	21 <sup>17</sup> / <sub>32</sub>	By description	By description	By description	By description
FWG30	27 <sup>17</sup> / <sub>32</sub>	By description	By description	By description	By description
FWG40	39 <sup>17</sup> / <sub>32</sub>	9205391	9205390	9205388	9205389

### Glass Stop - Stile / 1" Ref. No. 16 [page 15](#)

**Note:**  
One inch glass stops used with triple pane glass and BBG.

Unit No.	Length	Pine	Maple	Oak	White	Terratone
FWG68	64 <sup>55</sup> / <sub>64</sub>	9168012	By description	By description	By description	By description
FWG611	67 <sup>47</sup> / <sub>64</sub>	9168014	By description	By description	By description	By description
FWG80	80 <sup>55</sup> / <sub>64</sub>	By description	By description	By description	By description	By description

Unit No.	Length	Sandtone	Canvas	Dark Bronze	Black
FWG68	64 <sup>55</sup> / <sub>64</sub>	By description	By description	By description	By description
FWG611	67 <sup>47</sup> / <sub>64</sub>	By description	By description	By description	By description
FWG80	80 <sup>55</sup> / <sub>64</sub>	By description	By description	By description	By description

### Screw Package - Weatherstrip / Interlock

**Note:**  
Includes 22 screws, #7-18 x 5/8" Type AB PH FILL STL Z-D.

	Color	Order No.
	White	9149608
	Terratone®/ Sandtone	9149609



# 400 Series Frenchwood® Gliding Doors (1987 to Present)

2-Panel, 4-Panel, and Stationary

## Panels - Operating

### Panel Parts - Operating

#### Filler with Screws - Operating / Bottom Rail with Weatherstrip Ref. No. 5 [page 15](#)

**Note:**

Use gray for replacement where Terratone® is not available.

**Note:**

Filler for custom sized doors is made to order. Product ID label is located on top edge of operating panel.

To order, state:

1. Description of part (Operating Bottom Rail Filler)
2. Handing (RH or LH)
3. Quantity
4. Product ID (from product label, see [Service Guide 9051877](#))

#### Filler with Screws - Operating / Bottom Rail with Weatherstrip Ref. No. 5 [page 15](#)

**Note:**

80 height filler can be used as a replacement. Use gray for replacement where Terratone® is N/A.

	Unit No.	Length	Gray	Replace-ment	White	Replace-ment	Terra-tone®	Replace-ment
	<b>FWG2668/611</b>	30	2641407	-	9185329	-	2641021	-
	<b>FWG3068/611</b>	36	2641408	-	2572716	-	N/A	2641408
	<b>FWG4068/611</b>	48	N/A	2653719	2572718	-	N/A	2653719

#### Filler with Screws - Operating / Bottom Rail with Weatherstrip / 80 Height Ref. No. 13 [page 15](#)

**Note:**

Use gray for replacement where Terratone® is not available .Also used on Stormwatch® units

 80 Height Bottom Rail Filler	Unit No.	Length	Gray	Replace-ment	White	Replace-ment	Terra-tone®	Replace-ment
	<b>FWG26/80</b>	30	2653715	-	2572715	-	N/A	2653715
	<b>FWG30/80</b>	36	2653717	-	2572717	-	N/A	2653717
	<b>FWG40/80</b>	48	2653719	-	2572719	-	N/A	2653719

#### Weatherstrip - Operating / Bottom Rail / Fin Seal Ref. No. 6 [page 15](#)

**Note:**

Bottom rail fin seal weatherstrip is no longer available. Replace with bottom rail filler with Weatherstrip (above).

#### Trim Piece - Operating / Meeting Stile / Universal Ref. No. 4 [page 15](#)

Unit No.	Length	Pine	Oak	Maple	White	Dark Bronze	Black
<b>FWG68</b>	<b>76</b> <sup>9</sup> / <sub>64</sub>	2573008	2570363	2570369	2570375	9202655	9202643
<b>FWG611</b>	<b>79</b> <sup>1</sup> / <sub>64</sub>	2573009	2570364	2570370	2570376	9202656	9202644
<b>FWG80</b>	<b>92</b> <sup>9</sup> / <sub>64</sub>	2573014	2570365	2570371	2570377	9202657	9202645

## Panels - Operating

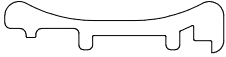
Stiffener - Operating / Side (Impact Resistant)						
	Unit No.	Length	Pine	Maple	Oak	Interior White
	<b>FWG68</b>	<b>76</b> <sup>5</sup> / <sub>32</sub>	2565649	2565646	2565655	2565652
	<b>FWG611</b>	<b>79</b> <sup>1</sup> / <sub>32</sub>	2565650	2565647	2565656	2565653
	<b>FWG80</b>	<b>92</b> <sup>5</sup> / <sub>32</sub>	2565651	2565648	2565657	2565654

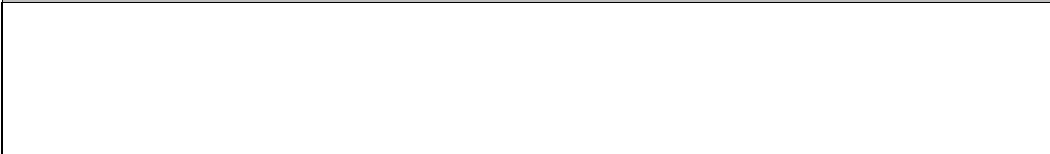
Screw Package - Stiffener (Impact Resistant)		
	Color	Order No.
	White	9033247
	Unfinished	9033250

Tandem Roller with Bracket (1982 to Present) No. 7 <a href="#">page 15</a>		
<b>Note:</b> See <a href="#">Roller Replacement/Adjustment Video</a> .		
		Order No.
		1997061

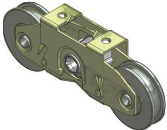
Tandem Roller (1998 to Present)		
<b>Note:</b> See <a href="#">Roller Replacement/Adjustment Video</a> . Also used on Stormwatch® units		
	Description	Order No.
	80/DP upgrade	2573517

Hole Plug - Operating / Handle		
	<b>Note:</b> Part is not visible.	Gray
		0912712

Hole Plug and Sleeve- Operating / Roller (1991 to Present) No. 8 <a href="#">page 15</a>			
	<b>Note:</b> Replaces previous vintages.	Color	
		White	9014683
		Terratone®	9014685
		Sandtone	9014684
		Tycote	9014686
Canvas	9046445		

# 400 Series Frenchwood® Gliding Doors (1987 to Present)

2-Panel, 4-Panel, and Stationary

## Panels - Operating

Weatherstrip / Dust Plug	
	<b>Order No.</b>
	9181460

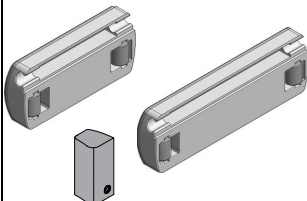
Operator Kit W/End Cap - Blinds Between the Glass					
Tilt/Height Adjustment	Unit No.	Color	Type	Order No.	
	<b>All</b>	White	Tilt/Height	9179702	

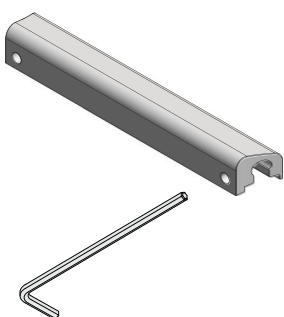
Intermediate Stop Kit - Blinds Between the Glass					
<b>Note:</b> See <a href="#">Accessory Guide 9184899</a> . Kit includes intermediate stop, hex key and set screws.					
	Unit No.	Color	Type	Order No.	
	<b>FWD</b>	White	Strike	9184901	

Head Panel Spacers				
	Length	Color	Order No.	
	4 ft	White	2573888	
		Terratone®	2653744	
		Forest Green	1262840	

**Panels - Stationary**

**Stationary Panel Graphic**

**Note:**  
See latest [Product Details](#).

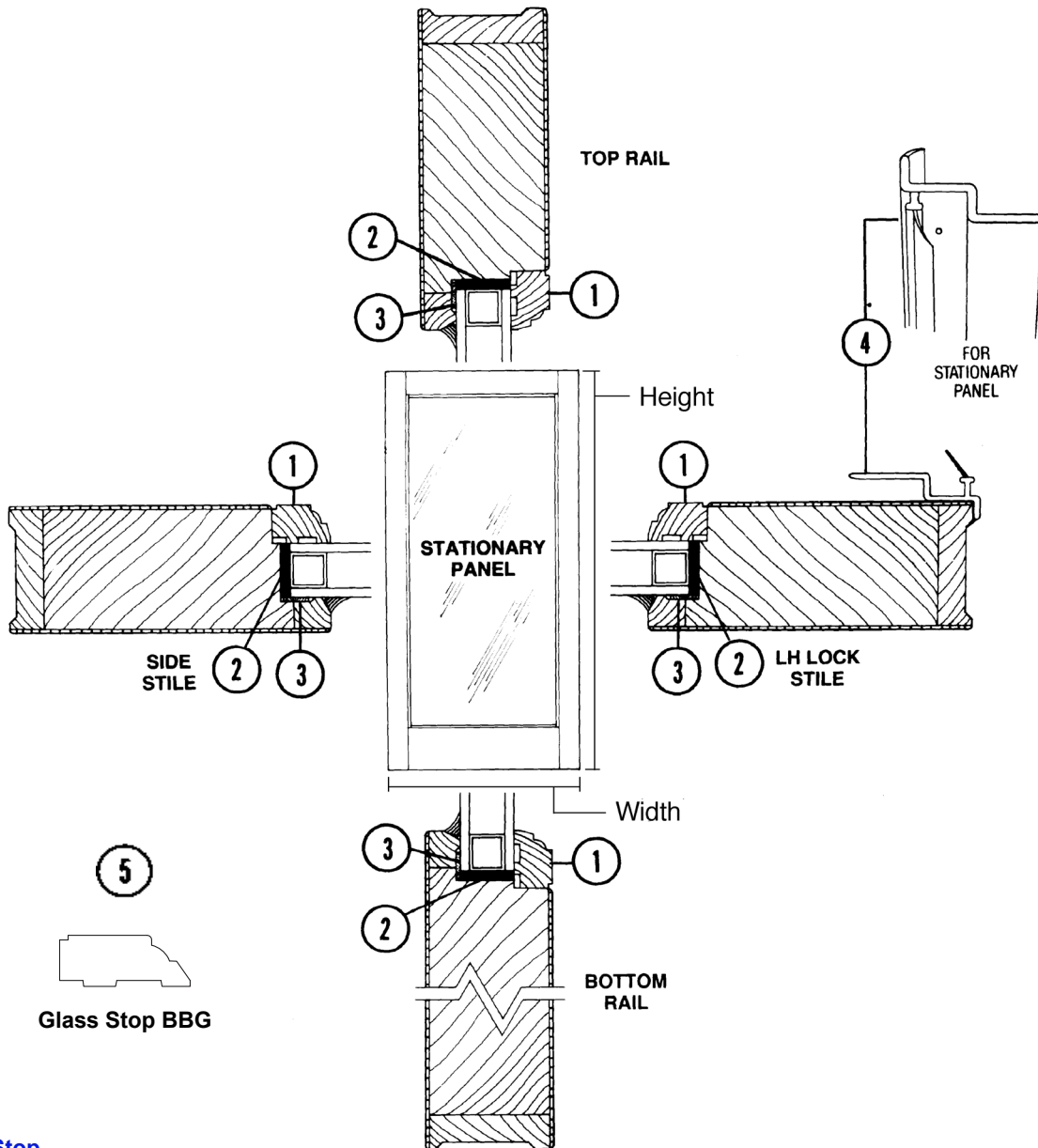

- 1. [Glass Stop](#)
- 2. Glass Spacers
- 3. Silicone Glazing
- 4. [Interlock W/S, Meeting Stile](#)
- 5. [Glass Stop - Blinds Between the Glass](#)

**Frenchwood® Gliding Stationary Panel (Left Hand Shown)**

*Unit viewed from exterior.*

# 400 Series Frenchwood® Gliding Doors (1987 to Present)

2-Panel, 4-Panel, and Stationary

## Panels - Stationary

### Stationary Panel Size Table

**Note:**

Stationary Panel is measured outside edge to outside edge of frame.

Unobstructed *Glass* is dimension from outside edge to outside edge of visible glass only.

Actual Glass is dimension of outside edge to outside edge of glass, including glass that is not visible.

1" Finelight™ grille profile is standard, with color matching exterior color of panel. Maple and Oak finishes introduced in 1999. Pre-finished white introduced in 2000.

Unit No.	Stationary Panel (w x h)	Unobstructed Glass (w x h)	Actual Glass (w x h)
FWG2668	30 × 76 <sup>9</sup> / <sub>64</sub>	21 <sup>1</sup> / <sub>8</sub> × 63 <sup>1</sup> / <sub>8</sub>	22 <sup>1</sup> / <sub>4</sub> × 64 <sup>1</sup> / <sub>4</sub>
FWG26611	30 × 79 <sup>1</sup> / <sub>64</sub>	21 <sup>1</sup> / <sub>8</sub> × 66	22 <sup>1</sup> / <sub>4</sub> × 67 <sup>1</sup> / <sub>8</sub>
FWG2680	30 × 92 <sup>9</sup> / <sub>64</sub>	21 <sup>1</sup> / <sub>8</sub> × 79 <sup>1</sup> / <sub>8</sub>	22 <sup>1</sup> / <sub>4</sub> × 80 <sup>1</sup> / <sub>4</sub>
FWG3068	36 × 76 <sup>9</sup> / <sub>64</sub>	27 <sup>1</sup> / <sub>8</sub> × 63 <sup>1</sup> / <sub>8</sub>	28 <sup>1</sup> / <sub>4</sub> × 64 <sup>1</sup> / <sub>4</sub>
FWG30611	36 × 79 <sup>1</sup> / <sub>64</sub>	27 <sup>1</sup> / <sub>8</sub> × 66	28 <sup>1</sup> / <sub>4</sub> × 67 <sup>1</sup> / <sub>8</sub>
FWG3080	36 × 92 <sup>9</sup> / <sub>64</sub>	27 <sup>1</sup> / <sub>8</sub> × 79 <sup>1</sup> / <sub>8</sub>	28 <sup>1</sup> / <sub>4</sub> × 80 <sup>1</sup> / <sub>4</sub>
FWG4068	48 × 76 <sup>9</sup> / <sub>64</sub>	39 <sup>1</sup> / <sub>8</sub> × 63 <sup>1</sup> / <sub>8</sub>	40 <sup>1</sup> / <sub>4</sub> × 64 <sup>1</sup> / <sub>4</sub>
FWG40611	48 × 79 <sup>1</sup> / <sub>64</sub>	39 <sup>1</sup> / <sub>8</sub> × 66	40 <sup>1</sup> / <sub>4</sub> × 67 <sup>1</sup> / <sub>8</sub>
FWG4080	48 × 92 <sup>9</sup> / <sub>64</sub>	39 <sup>1</sup> / <sub>8</sub> × 79 <sup>1</sup> / <sub>8</sub>	40 <sup>1</sup> / <sub>4</sub> × 80 <sup>1</sup> / <sub>4</sub>

### Stationary Panels

**Note:**

Panels are handed as unit is handed. As an example, a right-handed unit uses a right-handed operating panel and a right-handed stationary panel.

See [Panel Replacement Video](#). Assembled stationary panel ships with [stationary side jamb trim piece](#).

Stationary panels for custom sized doors are made to order. When replacing gliding door panels it is recommended to also replace the [interlock weatherstrip](#). Product ID label is located on top edge of operating panel. See iQ+ for additional glazing types available by description/configured.

To order, state:

1. Description of part (Stationary Panel)
2. Handing (RH or LH)
3. Quantity
4. Product ID (from product label, see [Service Guide 9051877](#))
5. Options Desired (if different than original product)

## Panels - Stationary

### Stationary Panel / High Performance Tempered Blinds Between Glass w/Tube

**Note:**

Handed as unit is handed. See iQ images below for 2-Panel detail (68 height shown). WH/PN and WH/WH first offered in October of 2015.

Qty	Part Number	Description
1	2565012	FWG6068SR, Frame, SR Handing, White/Clear Pine
1	9164463	FWG3068, Right Stationary Panel, White/Clear Pine, High Performance Low-E4 Tempered Blinds Between the Glass with Tubes
1	9164461	FWG3068, Right Operating Panel, White/Clear Pine, High Performance Low-E4 Tempered Blinds Between the Glass with Tubes

Qty	Part Number	Description
1	2565010	FWG6068LS, Frame, LS Handing, White/Clear Pine
1	9164464	FWG3068, Left Stationary Panel, White/Clear Pine, High Performance Low-E4 Tempered Blinds Between the Glass with Tubes
1	9164462	FWG3068, Left Operating Panel, White/Clear Pine, High Performance Low-E4 Tempered Blinds Between the Glass with Tubes

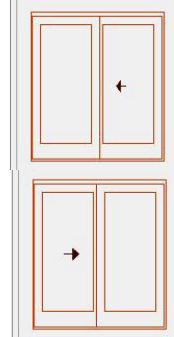

### Stationary Panel / High Performance Tempered BBG w/Tube / Pine Interior (May 2019 to Present)



		Exterior							
		White		Terratone®		Sandtone		Forest Green	
Unit No.		Interior							
		PINE							
		Left	Right	Left	Right	Left	Right	Left	Right
<b>30</b>	<b>FWG3068</b>	9164464	9164463	9179042	9179041	9179058	9179057	9179074	9179073
	<b>FWG30611</b>	9164476	9164475	9179050	9179049	9179066	9179065	9179082	9179081

### Stationary Panel / High Performance Tempered BBG w/Tube / White Interior (October 2015 to Present)



		Exterior							
		White		Terratone®		Sandtone		Forest Green	
Unit No.		Interior							
		White							
		Left	Right	Left	Right	Left	Right	Left	Right
<b>30</b>	<b>FWG3068</b>	9164460	9164459	9179038	9179037	9179054	9179053	9179070	9179069
	<b>FWG30611</b>	9164472	9164471	9179046	9179045	9179062	9179061	9179078	9179077

## 400 Series Frenchwood® Gliding Doors (1987 to Present)

*2-Panel, 4-Panel, and Stationary*

### Panels - Stationary

#### Stationary Panel / High Performance Low-E4® Tempered

Panel - Stationary / High-Performance-Low-E4® Tempered / Pine Interior					
Unit No.		Exterior			
		White	Terratone®	Sandtone	Forest Green
		Interior			
		PINE			
<b>26</b>	FWG2668	2565906	2651006	0911004	1262137
	FWG26611	2565903	2651003	0911005	1262139
	FWG2680	2565926	2651026	0911024	1262141
<b>30</b>	FWG3068	2565910	2651010	0911008	1262145
	FWG30611	2565918	2651018	0911016	1262147
	FWG3080	2565930	2651030	0911028	1262149
<b>40</b>	FWG4068	2565914	2651014	0911012	1262151
	FWG40611	2565920	2651020	0911018	1262153
	FWG4080	2565934	2651034	0911032	1262155

Panel - Stationary / High-Performance-Low-E4® Tempered / Maple Interior					
Unit No.		Exterior			
		White	Terratone®	Sandtone	Forest Green
		Interior			
		MAPLE			
<b>26</b>	FWG2668	2566238	2651070	0910975	By description
	FWG26611	2566236	2651078	0910976	By description
	FWG2680	2566250	By description	By description	By description
<b>30</b>	FWG3068	2566240	2651074	0910978	1262163
	FWG30611	2566246	2651080	0910984	By description
	FWG3080	2566252	2651086	0910990	By description
<b>40</b>	FWG4068	2566242	2651076	0910980	By description
	FWG40611	2566248	2651082	0910986	By description
	FWG4080	2566254	2651031	0910992	By description

Panel - Stationary / High-Performance-Low-E4® Tempered / Oak Interior					
Unit No.		Exterior			
		White	Terratone®	Sandtone	Forest Green
		Interior			
		OAK			
<b>26</b>	FWG2668	2566218	2651050	0910949	1262175
	FWG26611	2566216	2651058	0910950	1262177
	FWG2680	2566230	2651064	0910962	1262179
<b>30</b>	FWG3068	2566220	2651054	0910952	1262181
	FWG30611	2566226	2651060	0910958	1262183
	FWG3080	2566232	2651066	0910964	1262185
<b>40</b>	FWG4068	2566222	2651056	0910954	1262187
	FWG40611	2566228	2651062	0910960	1262189
	FWG4080	2566234	2651068	0910966	1262191

## Panels - Stationary

Panel - Stationary / High-Performance-Low-E4 <sup>®</sup> Tempered / Interior White		
	Unit No.	Exterior
		White
		Interior
		White
<b>26</b>	<b>FWG2668</b>	2566202
	<b>FWG26611</b>	2566258
	<b>FWG2680</b>	2566260
<b>30</b>	<b>FWG3068</b>	2566264
	<b>FWG30611</b>	2566262
	<b>FWG3080</b>	2566266
<b>40</b>	<b>FWG4068</b>	2566270
	<b>FWG40611</b>	2566268
	<b>FWG4080</b>	2566272



# 400 Series Frenchwood® Gliding Doors (1987 to Present)

2-Panel, 4-Panel, and Stationary

## Panels - Stationary

### Stationary Panel / High Performance Low-E4® Smart Sun Tempered

#### Panel - Stationary / High-Performance-Low-E4® Tempered / Smart Sun / Pine Interior

Unit No.		Exterior			
		White	Terratone®	Sandtone	Forest Green
		Interior			
		PINE			
<b>26</b>	<b>FWG2668</b>	By description	By description	By description	By description
	<b>FWG26611</b>	By description	By description	By description	By description
	<b>FWG2680</b>	By description	By description	By description	By description
<b>30</b>	<b>FWG3068</b>	9021469	9021403	9021402	By description
	<b>FWG30611</b>	By description	By description	By description	By description
	<b>FWG3080</b>	By description	By description	By description	By description
<b>40</b>	<b>FWG4068</b>	9021471	9021407	9021406	By description
	<b>FWG40611</b>	By description	By description	By description	By description
	<b>FWG4080</b>	By description	By description	By description	By description

**Panels - Stationary**

**Stationary Panel / High Performance Low-E4® Sun Tempered**

Panel - Stationary / High-Performance-Low-E4® Sun Tempered / Pine Interior					
Unit No.		Exterior			
		White	Terratone®	Sandtone	Forest Green
		Interior			
		PINE			
26	FWG2668	2566006	2651206	0911104	By description
	FWG26611	2566003	2651203	0911105	By description
	FWG2680	2566036	2651226	0911124	By description
30	FWG3068	2566020	2651210	0911108	By description
	FWG30611	2566028	2651218	0911116	By description
	FWG3080	2566040	2651230	0911128	By description
40	FWG4068	2566024	2651214	0911112	By description
	FWG40611	2566030	2651220	0911118	By description
	FWG4080	2566044	2651234	0911132	By description

Panel - Stationary / High-Performance-Low-E4® Sun Tempered / Maple Interior					
Unit No.		Exterior			
		White	Terratone®	Sandtone	Forest Green
		Interior			
		MAPLE			
26	FWG2668	2566068	By description	By description	By description
	FWG26611	By description	By description	By description	By description
	FWG2680	By description	By description	By description	By description
30	FWG3068	2566070	2651265	0911146	By description
	FWG30611	By description	By description	By description	By description
	FWG3080	By description	By description	0911158	By description
40	FWG4068	2566072	By description	0911160	By description
	FWG40611	By description	By description	By description	By description
	FWG4080	By description	By description	By description	By description

Panel - Stationary / High-Performance-Low-E4® Sun Tempered / Oak Interior					
Unit No.		Exterior			
		White	Terratone®	Sandtone	Forest Green
		Interior			
		OAK			
26	FWG2668	2566048	2651237	0911109	By description
	FWG26611	2566046	2651236	0911111	By description
	FWG2680	2566060	2651249	0911136	By description
30	FWG3068	2566050	2651239	0911120	By description
	FWG30611	2566056	2651245	0911131	By description
	FWG3080	2566062	2651251	0911138	By description
40	FWG4068	2566052	2651241	0911123	By description
	FWG40611	2566058	2651247	0911134	By description
	FWG4080	2566064	2651253	0911140	By description

## 400 Series Frenchwood® Gliding Doors (1987 to Present)

*2-Panel, 4-Panel, and Stationary*

### Panels - Stationary

Panel - Stationary / High-Performance-Low-E4® Sun Tempered / Interior White		
Unit No.		Exterior
		White
		Interior
		White
<b>26</b>	FWG2668	2566292
	FWG26611	2566294
	FWG2680	2566296
<b>30</b>	FWG3068	2566301
	FWG30611	2566298
	FWG3080	2566303
<b>40</b>	FWG4068	2566307
	FWG40611	2566305
	FWG4080	2566311

## Panels - Stationary

### Stationary Panel / High Performance Sun II Tempered

#### Panel - Stationary / High-Performance Sun II Tempered / Pine Interior

**Note:**  
Available by description.

#### Panel - Stationary / High-Performance Sun II Tempered / Maple Interior

**Note:**  
Available by description.

#### Panel - Stationary / High-Performance Sun II Tempered / Oak Interior

**Note:**  
Available by description.

#### Panel - Stationary / High-Performance Sun II Tempered / Interior White

**Note:**  
Available by description.

### Stationary Panel / High Performance Sun Bronze Tempered

**Note:**  
Impact resistant High-Performance Sun II Tempered, Gray Laminated Monolithic panels, and Clear Laminated Monolithic panels are available by description.

#### Panel - Stationary / HP Sun Bronze Tempered / Pine Interior

Unit No.	Exterior			
	White	Terratone®	Sandtone	Forest Green
	Interior			
	PINE			
<b>FWG2668</b>	By description	By description	By description	By description
<b>FWG26611</b>	By description	By description	By description	By description
<b>FWG2680</b>	By description	By description	By description	By description
<b>FWG3068</b>	By description	2651110	By description	By description
<b>FWG30611</b>	By description	By description	By description	By description
<b>FWG3080</b>	By description	By description	By description	By description
<b>FWG4068</b>	By description	2651114	By description	By description
<b>FWG40611</b>	By description	By description	By description	By description
<b>FWG4080</b>	By description	By description	By description	By description

# 400 Series Frenchwood® Gliding Doors (1987 to Present)

2-Panel, 4-Panel, and Stationary

## Panels - Stationary

### Stationary Panel / High Performance Low-E4® Tempered Finelight™

Panel - Stationary / High-Performance-Low-E4® Tempered Finelight™ / Pine Interior					
Unit No.		Exterior			
		White	Terratone®	Sandtone	Forest Green
		Interior PINE			
26	FWG2668	2566102	By description	0911174	By description
	FWG26611	2566108	By description	0911180	By description
	FWG2680	2566114	By description	0911186	By description
30	FWG3068	2566104	2651118	0911176	By description
	FWG30611	2566110	2651124	0911182	By description
	FWG3080	2566116	By description	0911188	By description
40	FWG4068	2566106	By description	0911178	By description
	FWG40611	2566112	By description	0911184	By description
	FWG4080	2566118	By description	0911190	By description

Panel - Stationary / High-Performance-Low-E4® Tempered Finelight™ / Maple Interior					
Unit No.		Exterior			
		White	Terratone®	Sandtone	Forest Green
		Interior MAPLE			
26	FWG2668	By description	By description	By description	By description
	FWG26611	By description	By description	By description	By description
	FWG2680	By description	By description	By description	By description
30	FWG3068	2566140	By description	By description	By description
	FWG30611	By description	By description	By description	By description
	FWG3080	By description	By description	By description	By description
40	FWG4068	By description	By description	By description	By description
	FWG40611	By description	By description	By description	By description
	FWG4080	By description	By description	By description	By description

Panel - Stationary / High-Performance-Low-E4® Tempered Finelight™ / Oak Interior					
Unit No.		Exterior			
		White	Terratone®	Sandtone	Forest Green
		Interior OAK			
26	FWG2668	2566120	By description	By description	By description
	FWG26611	By description	By description	By description	By description
	FWG2680	By description	By description	0911205	By description
30	FWG3068	2566122	By description	0911194	By description
	FWG30611	2566128	By description	0911201	By description
	FWG3080	By description	By description	By description	By description
40	FWG4068	2566124	By description	By description	By description
	FWG40611	By description	By description	By description	By description
	FWG4080	By description	By description	By description	By description

## Panels - Stationary

Panel - Stationary / High-Performance-Low-E4® Tempered Finelight™ / Interior White		
Unit No.		Exterior
		White
		Interior
		White
<b>26</b>	<b>FWG2668</b>	2566276
	<b>FWG26611</b>	2566274
	<b>FWG2680</b>	2566278
<b>30</b>	<b>FWG3068</b>	2566282
	<b>FWG30611</b>	2566280
	<b>FWG3080</b>	2566284
<b>40</b>	<b>FWG4068</b>	2566288
	<b>FWG40611</b>	2566286
	<b>FWG4080</b>	2566290

# 400 Series Frenchwood® Gliding Doors (1987 to Present)

2-Panel, 4-Panel, and Stationary

## Panels - Stationary

### Stationary Panel / Stormwatch®

**Note:**

Impact resistant High-Performance Sun II Tempered, Gray Laminated Monolithic panels, and Clear Laminated Monolithic panels are available by description.

#### Panel - Stationary / High-Performance-Low-E4® Tempered (Impact Resistant) / Pine Interior

Unit No.	Exterior			
	White	Terratone®	Sandtone	Forest Green
	Interior PINE			
FWG2668	2560515	By description	By description	By description
FWG26611	By description	By description	By description	By description
FWG2680	By description	By description	By description	By description
FWG3068	2560521	By description	By description	By description
FWG30611	2560523	By description	By description	By description
FWG3080	2560525	By description	0910511	By description
FWG4068	2560527	By description	By description	By description
FWG40611	2560529	By description	By description	By description
FWG4080	2560531	By description	By description	By description

#### Panel - Stationary / High-Performance-Low-E4® Tempered (Impact Resistant) / Maple Interior

Unit No.	Exterior			
	White	Terratone®	Sandtone	Forest Green
	Interior MAPLE			
FWG2668	By description	By description	By description	By description
FWG26611	By description	By description	By description	By description
FWG2680	By description	By description	By description	By description
FWG3068	By description	By description	By description	By description
FWG30611	By description	By description	By description	By description
FWG3080	By description	By description	By description	By description
FWG4068	By description	By description	By description	By description
FWG40611	By description	By description	By description	By description
FWG4080	By description	By description	By description	By description

## Panels - Stationary

Panel - Stationary / High-Performance-Low-E4® Tempered (Impact Resistant) / Oak Interior				
Unit No.	Exterior			
	White	Terratone®	Sandtone	Forest Green
	Interior 			
<b>FWG2668</b>	By description	By description	By description	By description
<b>FWG26611</b>	By description	By description	By description	By description
<b>FWG2680</b>	By description	By description	By description	By description
<b>FWG3068</b>	By description	By description	By description	By description
<b>FWG30611</b>	By description	By description	By description	By description
<b>FWG3080</b>	By description	By description	By description	By description
<b>FWG4068</b>	By description	By description	By description	By description
<b>FWG40611</b>	By description	By description	By description	By description
<b>FWG4080</b>	By description	By description	By description	By description

Panel - Stationary / High-Performance-Low-E4® Tempered (Impact Resistant) / Interior White	
Unit No.	Exterior/Interior
	White
<b>FWG2668</b>	2560534
<b>FWG26611</b>	By description
<b>FWG2680</b>	By description
<b>FWG3068</b>	2560540
<b>FWG30611</b>	2560542
<b>FWG3080</b>	2560544
<b>FWG4068</b>	By description
<b>FWG40611</b>	By description
<b>FWG4080</b>	By description

Panel - Stationary / High-Performance-Low-E4® Sun 3 Tempered (Impact Resistant) / Pine Interior				
Unit No.	Exterior			
	White	Terratone®	Sandtone	Forest Green
	Interior 			
<b>FWG2668</b>	By description	By description	By description	By description
<b>FWG26611</b>	By description	By description	By description	By description
<b>FWG2680</b>	By description	By description	By description	By description
<b>FWG3068</b>	By description	By description	By description	By description
<b>FWG30611</b>	By description	By description	By description	By description
<b>FWG3080</b>	By description	By description	By description	By description
<b>FWG4068</b>	By description	By description	By description	By description
<b>FWG40611</b>	By description	By description	By description	By description
<b>FWG4080</b>	By description	By description	0910535	By description



# 400 Series Frenchwood® Gliding Doors (1987 to Present)

*2-Panel, 4-Panel, and Stationary*

## Panels - Stationary

### Panel - Stationary / High-Performance-Low-E4® Sun 3 Tempered (Impact Resistant) / Maple Interior

Unit No.	Exterior			
	White	Terratone®	Sandtone	Forest Green
	Interior <b>MAPLE</b>			
<b>FWG2668</b>	By description	By description	By description	By description
<b>FWG26611</b>	By description	By description	By description	By description
<b>FWG2680</b>	By description	By description	By description	By description
<b>FWG3068</b>	By description	By description	By description	By description
<b>FWG30611</b>	By description	By description	By description	By description
<b>FWG3080</b>	By description	By description	By description	By description
<b>FWG4068</b>	By description	By description	By description	By description
<b>FWG40611</b>	By description	By description	By description	By description
<b>FWG4080</b>	By description	By description	By description	By description

### Panel - Stationary / High-Performance-Low-E4® Sun 3 Tempered (Impact Resistant) / Oak Interior

Unit No.	Exterior			
	White	Terratone®	Sandtone	Forest Green
	Interior <b>OAK</b>			
<b>FWG2668</b>	By description	By description	By description	By description
<b>FWG26611</b>	By description	By description	By description	By description
<b>FWG2680</b>	By description	By description	By description	By description
<b>FWG3068</b>	By description	By description	By description	By description
<b>FWG30611</b>	By description	By description	By description	By description
<b>FWG3080</b>	By description	By description	By description	By description
<b>FWG4068</b>	By description	By description	By description	By description
<b>FWG40611</b>	By description	By description	By description	By description
<b>FWG4080</b>	By description	By description	By description	By description

### Panel - Stationary / High-Performance-Low-E4® Sun 3 Tempered (Impact Resistant) / Interior White

Unit No.	Exterior/Interior
	White
<b>FWG2668</b>	By description
<b>FWG26611</b>	By description
<b>FWG2680</b>	By description
<b>FWG3068</b>	By description
<b>FWG30611</b>	By description
<b>FWG3080</b>	By description
<b>FWG4068</b>	By description
<b>FWG40611</b>	By description
<b>FWG4080</b>	By description

## Panels - Stationary

<b>Stationary Panel / DP Upgrade</b>				
<b>Panel - Stationary / HP Sun Tempered (DP Upgrade) / Pine</b>				
	<b>Unit No.</b>	<b>Exterior</b>		
		<b>White</b>	<b>Terratone®</b>	<b>Sandtone</b>
		<b>Interior</b>		
		<b>PINE</b>		
	<b>FWG2668</b>	By description	By description	By description
	<b>FWG26611</b>	By description	By description	By description
	<b>FWG2680</b>	By description	By description	By description
	<b>FWG3068</b>	By description	By description	By description
	<b>FWG30611</b>	By description	By description	By description
	<b>FWG3080</b>	By description	By description	By description
<b>FWG4068</b>	By description	By description	By description	
<b>FWG40611</b>	By description	By description	By description	
<b>FWG4080</b>	By description	By description	By description	

<b>Panel - Stationary / HP Sun Tempered (DP Upgrade) / Maple</b>				
	<b>Unit No.</b>	<b>Exterior</b>		
		<b>White</b>	<b>Terratone®</b>	<b>Sandtone</b>
		<b>Interior</b>		
		<b>MAPLE</b>		
	<b>FWG2668</b>	By description	By description	By description
	<b>FWG26611</b>	By description	By description	By description
	<b>FWG2680</b>	By description	By description	By description
	<b>FWG3068</b>	By description	By description	By description
	<b>FWG30611</b>	By description	By description	By description
	<b>FWG3080</b>	By description	By description	By description
<b>FWG4068</b>	By description	By description	By description	
<b>FWG40611</b>	By description	By description	By description	
<b>FWG4080</b>	By description	By description	By description	

<b>Panel - Stationary / HP Sun Tempered (DP Upgrade) / Oak</b>				
	<b>Unit No.</b>	<b>Exterior</b>		
		<b>White</b>	<b>Terratone®</b>	<b>Sandtone</b>
		<b>Interior</b>		
		<b>OAK</b>		
	<b>FWG2668</b>	By description	By description	By description
	<b>FWG26611</b>	By description	By description	By description
	<b>FWG2680</b>	By description	By description	By description
	<b>FWG3068</b>	By description	By description	By description
	<b>FWG30611</b>	By description	By description	By description
	<b>FWG3080</b>	By description	By description	By description
<b>FWG4068</b>	By description	By description	By description	
<b>FWG40611</b>	By description	By description	By description	
<b>FWG4080</b>	By description	By description	By description	

# 400 Series Frenchwood® Gliding Doors (1987 to Present)

2-Panel, 4-Panel, and Stationary

## Panels - Stationary

### Glass Stops - Stationary

**Note:**

When replacing white painted stops with PVC stops, all 4 sides must be replaced. Glass Stops for custom sized doors are made to order. Product ID label is located on top edge of operating panel.

To order, state:

1. Description of part (Glass Stop, Rail or Stile)
2. Quantity
3. Product ID (from product label, see [Service Guide 9051877](#))

### Glass Stop - Rail Ref. No. 1 [page 36](#)

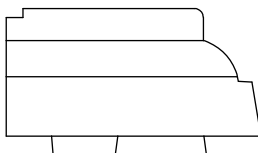

Unit No.	Length	Pine	Maple	Oak	White	Terratone
<b>FWG26</b>	<b>21</b> <sup>17</sup> / <sub>32</sub>	2572812	2572829	2572825	2572347	By description
<b>FWG30</b>	<b>27</b> <sup>17</sup> / <sub>32</sub>	2572816	2572836	2572833	2572348	By description
<b>FWG40</b>	<b>39</b> <sup>17</sup> / <sub>32</sub>	2572818	2572837	2572834	2572349	By description

Unit No.	Length	Sandtone	Canvas	Dark Bronze	Black
<b>FWG26</b>	<b>21</b> <sup>17</sup> / <sub>32</sub>	By description	By description	By description	By description
<b>FWG30</b>	<b>27</b> <sup>17</sup> / <sub>32</sub>	By description	By description	By description	By description
<b>FWG40</b>	<b>39</b> <sup>17</sup> / <sub>32</sub>	By description	By description	By description	By description

### Glass Stop - Stile Ref. No. 1 [page 36](#)

Unit No.	Length	Pine	Maple	Oak	White	Terratone
<b>FWG68</b>	<b>64</b> <sup>55</sup> / <sub>64</sub>	2572820	2572838	2572835	2572350	
<b>FWG611</b>	<b>67</b> <sup>47</sup> / <sub>64</sub>	2572824	2572832	2572828	2572351	
<b>FWG80</b>	<b>80</b> <sup>55</sup> / <sub>64</sub>	2572822	2572830	2572826	2572352	

Unit No.	Length	Sandtone	Canvas	Dark Bronze	Black
<b>FWG68</b>	<b>64</b> <sup>55</sup> / <sub>64</sub>	By description	By description	By description	By description
<b>FWG611</b>	<b>67</b> <sup>47</sup> / <sub>64</sub>	By description	By description	By description	By description
<b>FWG80</b>	<b>80</b> <sup>55</sup> / <sub>64</sub>	By description	By description	By description	By description

## Panels - Stationary

### Glass Stop - Rail / 1" Ref. No. 16 [page 15](#)

**Note:**

One inch glass stops used with triple pane glass and BBG.



Unit No.	Length	Pine	Maple	Oak	White	Terratone
<b>FWG26</b>	<b>21</b> <sup>17</sup> / <sub>32</sub>	By description	By description	By description	By description	By description
<b>FWG30</b>	<b>27</b> <sup>17</sup> / <sub>32</sub>	9168010	By description	By description	By description	By description
<b>FWG40</b>	<b>39</b> <sup>17</sup> / <sub>32</sub>	9205384	9205386	9205385	9205387	9205392

Unit No.	Length	Sandtone	Canvas	Dark Bronze	Black
<b>FWG26</b>	<b>21</b> <sup>17</sup> / <sub>32</sub>	By description	By description	By description	By description
<b>FWG30</b>	<b>27</b> <sup>17</sup> / <sub>32</sub>	By description	By description	By description	By description
<b>FWG40</b>	<b>39</b> <sup>17</sup> / <sub>32</sub>	9205391	9205390	9205388	9205389

### Glass Stop - Stile / 1" Ref. No. 16 [page 15](#)

**Note:**

One inch glass stops used with triple pane glass and BBG.

Unit No.	Length	Pine	Maple	Oak	White	Terratone
<b>FWG68</b>	<b>64</b> <sup>55</sup> / <sub>64</sub>	9168012	By description	By description	By description	By description
<b>FWG611</b>	<b>67</b> <sup>47</sup> / <sub>64</sub>	9168014	By description	By description	By description	By description
<b>FWG80</b>	<b>80</b> <sup>55</sup> / <sub>64</sub>	By description	By description	By description	By description	By description

Unit No.	Length	Sandtone	Canvas	Dark Bronze	Black
<b>FWG68</b>	<b>64</b> <sup>55</sup> / <sub>64</sub>	By description	By description	By description	By description
<b>FWG611</b>	<b>67</b> <sup>47</sup> / <sub>64</sub>	By description	By description	By description	By description
<b>FWG80</b>	<b>80</b> <sup>55</sup> / <sub>64</sub>	By description	By description	By description	By description

# 400 Series Frenchwood® Gliding Doors (1987 to Present)

2-Panel, 4-Panel, and Stationary

## Panels - Stationary

### Interlock - Set

**Note:**

See [Service Guide 9131890](#). See [Replacement Video](#).

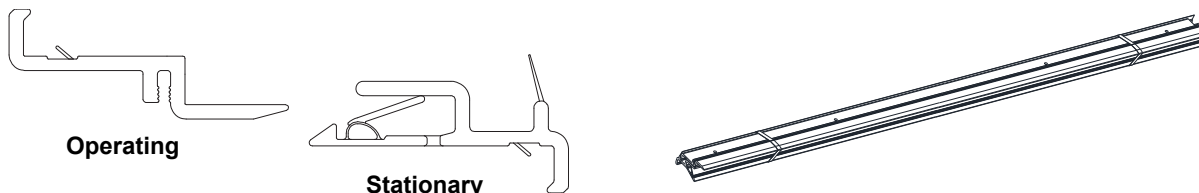

**Note:**

Interlock sets for custom sized doors are made to order. Product ID label is located on top edge of operating panel.

To order, state:

1. Description of part (Interlock Set/Color)
2. Quantity
3. Product ID (from product label, see [Service Guide 9051877](#))

#### Interlock Set w/Screws (1990 to Present) Ref. No. 9 [page 15](#)

**Note:**

Includes stationary weatherstrip, operating weatherstrip, interlock replacement plug kit and screw pack. Replacement for non-white colors and may not match color of weatherstrip being replaced. See [Service Guide 9131890](#).

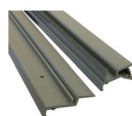

Unit No.	Length	White	Gray (Snd)
FWG68	76 <sup>7</sup> / <sub>16</sub>	2400504	2400501
FWG611	79 <sup>5</sup> / <sub>16</sub>	2400503	2400502
FWG80	92 <sup>7</sup> / <sub>16</sub>	2400508	2400507

#### Interlock Set w/Screws / 4 Panel (May 2020 to Present)

**Note:**

Includes stationary weatherstrip, operating weatherstrip, interlock replacement plug kit and screw pack. Replacement for non-white colors and may not match color of weatherstrip being replaced. See [Service Guide 9131890](#).

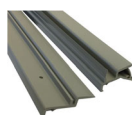

Unit No.	Length	White	Gray
FWG68	76 <sup>7</sup> / <sub>16</sub>	9184279	9184280
FWG611	79 <sup>5</sup> / <sub>16</sub>	9184281	9184282
FWG80	92 <sup>7</sup> / <sub>16</sub>	9184283	9184284

### Interlock Weatherstrip Replacement Plug Kit

**Note:**

Kit includes sill plugs, head plug, dust plug and [Service Guide 9131890](#). See individual frame parts (sill/head plugs) in [frame section](#), individual panel parts (dust plug) in [operating panel section](#).

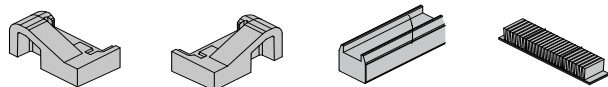

**Order No.**

9131915

### Screw Package - Weatherstrip / Interlock

**Note:**

Includes 22 screws, #7-18 x 5/8" Type AB PH FILL STL Z-D

Color	Order No.
White	9149608
Sandtone	9149609

## Panels - Stationary

### Panel Parts - Stationary

#### Bracket with Screws - Stationary / Universal

	<b>Note:</b> See <a href="#">Service Guide 9018154</a> .	<b>Unit No.</b>	<b>Finish</b>	<b>Order No.</b>
		<b>FWG68/80 (Universal)</b>	Stone	2573551
			White	2573549

#### Operator Kit W/End Cap - Blinds Between the Glass

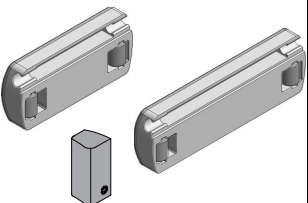
<b>Tilt/Height Adjustment</b>		<b>Unit No.</b>	<b>Color</b>	<b>Type</b>	<b>Order No.</b>
		<b>All</b>	White	Tilt/Height	9179702

#### Intermediate Stop Kit - Blinds Between the Glass

**Note:**  
See [Accessory Guide 9184899](#). Kit includes intermediate stop, hex key and set screws.

	<b>Unit No.</b>	<b>Color</b>	<b>Type</b>	<b>Order No.</b>
	<b>FWD</b>	White	Strike	9184901

#### Stiffener - Stationary / Side (Impact Resistant)

**Note:**  
See [Service Guide 0005407](#).

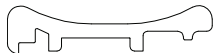
	<b>Unit No.</b>	<b>Length</b>	<b>White</b>	<b>Terratone®</b>	<b>Sandtone</b>	<b>Forest Green</b>	<b>Canvas</b>	<b>D Bronze</b>	<b>Black</b>
	<b>FWG68</b>	<b>76 7/8</b>	2565658	2653151	0912219	1267823	9186295	9186292	9186289
	<b>FWG611</b>	<b>79 3/4</b>	2565659	2653152	0912220	1267824	9186296	9186293	9186290
	<b>FWG80</b>	<b>92 7/8</b>	2565660	2653153	0912221	1267825	9186297	9186294	9186291

# 400 Series Frenchwood® Gliding Doors (1987 to Present)

2-Panel, 4-Panel, and Stationary

## Panels - Stationary

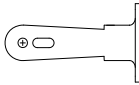
Bracket - Universal / Head and Sill (Impact Resistant)		
	<b>Note:</b> Applied to head and sill on stat panel.	<b>Order No.</b>
		2579406

Screw Package - Stiffener / Exterior (Impact Resistant)																		
<b>Note:</b> Some screws and fasteners in screw pack may need to be discarded. See PKD 0681 for contents.																		
		<table border="1"> <thead> <tr> <th>Color</th> <th>Order No.</th> </tr> </thead> <tbody> <tr> <td>White</td> <td>9033236</td> </tr> <tr> <td>Terratone®</td> <td>9033238</td> </tr> <tr> <td>Sandtone</td> <td>9033237</td> </tr> <tr> <td>Forest Green</td> <td>9033239</td> </tr> <tr> <td>Canvas</td> <td>9033240</td> </tr> <tr> <td>Black</td> <td>9033242</td> </tr> <tr> <td>Dark Bronze</td> <td>9033246</td> </tr> </tbody> </table>	Color	Order No.	White	9033236	Terratone®	9033238	Sandtone	9033237	Forest Green	9033239	Canvas	9033240	Black	9033242	Dark Bronze	9033246
		Color	Order No.															
		White	9033236															
		Terratone®	9033238															
		Sandtone	9033237															
		Forest Green	9033239															
		Canvas	9033240															
Black	9033242																	
Dark Bronze	9033246																	

## Insect Screens

### Insect Screen Graphic - Gliding 2 & 4-Panel / Current (1991 to Present)

\*Circled numbers with no directional lines refer to parts not shown in drawing, but are listed below or see hardware section.

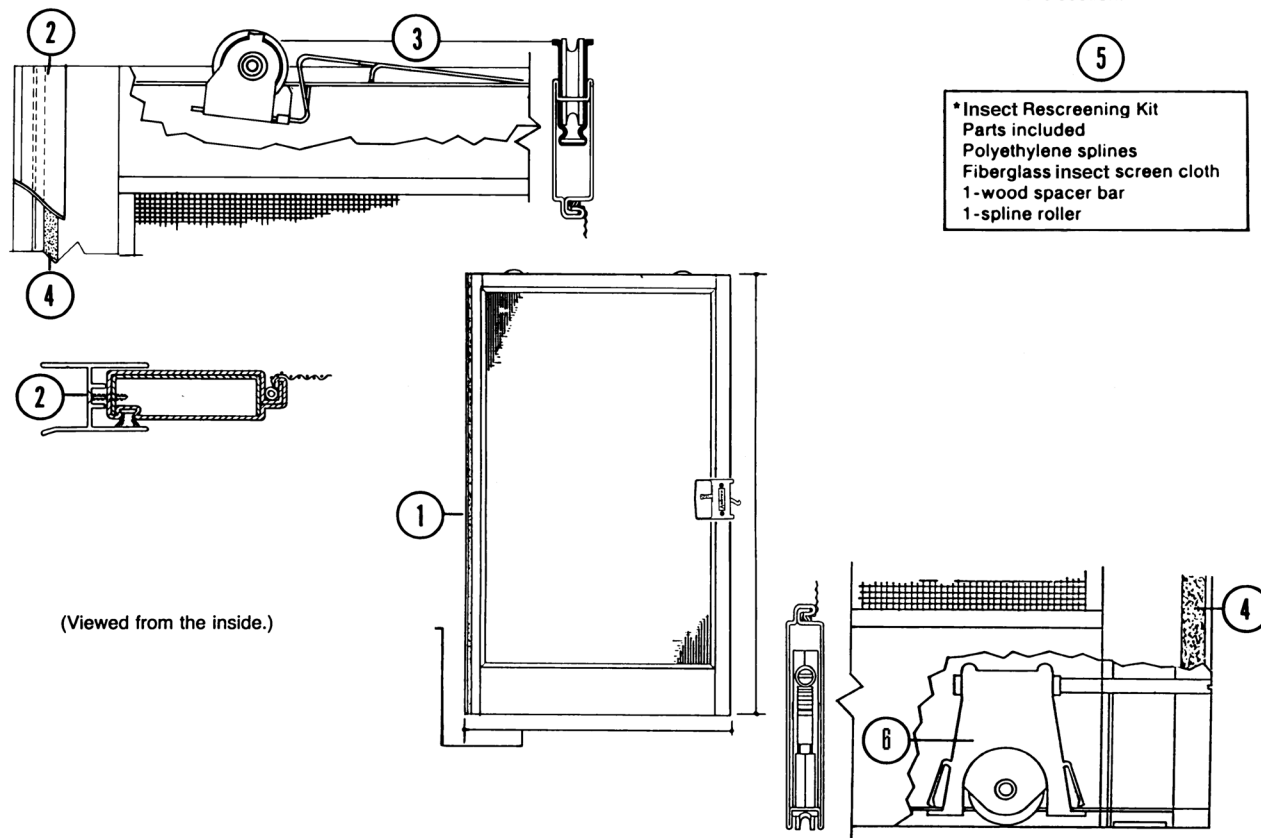

**5**

**\*Insect Rescreening Kit**  
 Parts included  
 Polyethylene splines  
 Fiberglass insect screen cloth  
 1-wood spacer bar  
 1-spline roller

(Viewed from the inside.)

1. [Insect Screen](#)
2. [Insect Screen Astragal - 4-panel Door](#)
3. [Upper Insect Screen Roller](#)
4. [Bug Seal Pile Weatherstrip](#)
5. [Insect Rescreening Kit](#)
6. [Bottom Insect Screen Roller](#)

Manufactured 1991 to Present

**Frenchwood® Gliding Insect Screen**

*Viewed from the interior*



# 400 Series Frenchwood® Gliding Doors (1987 to Present)

2-Panel, 4-Panel, and Stationary

## Insect Screens

### Insect Screen Graphic - Gliding 2 & 4-Panel / Vintage (1987 to 1991)

**Note:**

Use current model of insect screen for replacement. Other replacement parts are available.

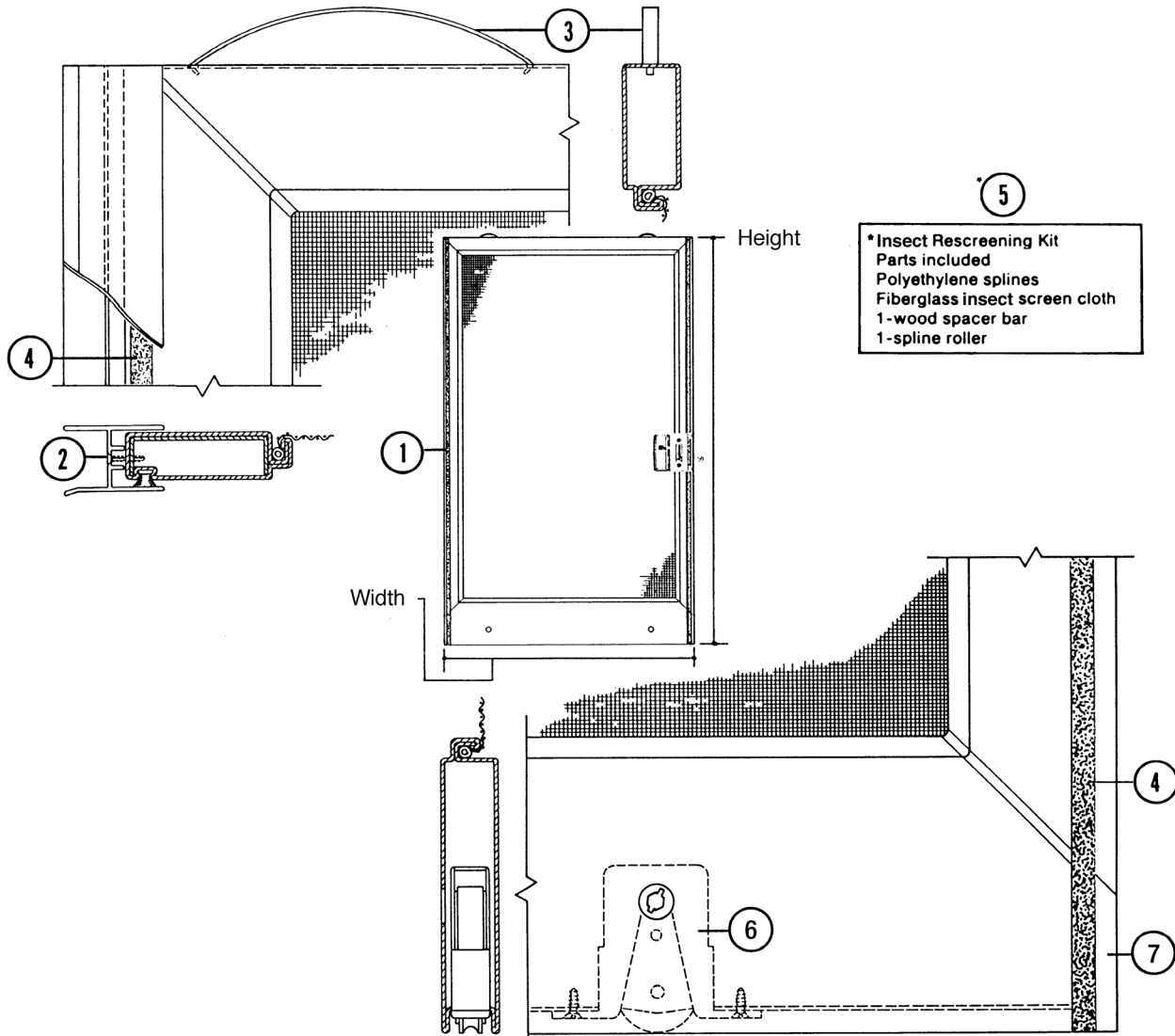

1. [Insect Screen](#)
2. [Astragal, Insect Screen W/Screws - 4-Panel Door](#)
3. [Spring, Top Door](#)
4. [Bug Seal Pile Weatherstrip](#)
5. [Insect Rescreening Kit](#)
6. [Bottom Insect Screen Roller](#)
7. [End Caps, Insect Screen Bottom Rail](#)

Manufactured 1987 to 1991

**Frenchwood® Gliding Insect Screen**

*Viewed from the interior*

## Insect Screens

### Gliding Insect Screens - Universal

**Note:**

Gliding insect screens for custom sized doors are made to order. Product ID label is located on top edge of operating panel. Replacement screens ship with top and bottom rollers and hardware. See [Accessory Guide 0001666](#). See [Installation Video](#).

To order, state:

1. Description of part (Gliding Insect Screen)
2. Quantity
3. Product ID (from product label, see [Service Guide 9051877](#))
4. Options Desired (if different than original product)

Gliding Screen Usage Chart		
Screen	FWG Unit	
	FWG Two Panel Door	FWG Four Panel Door
PD2668	FWG5068	FWG10068
PD26611	FWG50611	FWG100611
PD2680	FWG5080	FWG10080
PD3068	FWG6068	FWG12068
PD30611	FWG60611	FWG120611
PD3080	FWG6080	FWG12080
PD4068	FWG8068	FWG16068
PD40611	FWG80611	FWG160611
PD4080	FWG8080	FWG16080

### Gliding Insect Screens - Universal (1987 to Present) Ref. No. 1 [page 56](#)

**Note:**

Four panel doors use two screens and [astragal kit](#).

Unit No.	Dimensions	White	Terratone®	Sandtone	Forest Green	Canvas	Dark Bronze
PD2668	29 1/2 x 77 9/16	1974128	2601022	0900202	1262501	9134443	9134447
PD26611	29 1/2 x 80 7/16	2565309	2650309	0910105	1262505	9138812	9138820
PD2680	29 1/2 x 93 9/16	2576018	2666018	0910112	1262509	9138816	9138824
PD3068	35 1/2 x 77 9/16	2565308	2650306	0910102	1262503	9138810	9138818
PD30611	35 1/2 x 80 7/16	2565311	2650311	0910107	1262507	9138813	9138821
PD3080	35 1/2 x 93 9/16	2576022	2666022	0910114	1262511	9138817	9138825
PD4068	47 1/2 x 77 9/16	2565316	2650308	0910104	1262504	9138811	9138819
PD40611	47 1/2 x 80 7/16	2565312	2650312	0910108	1262508	9138814	9138822
PD4080	47 1/2 x 93 9/16	2565328	2650328	0910116	1262512	9138815	9138823

### Rescreening Kits - Gliding Insect Screen

#### Rescreening Kit - Gliding Insect Screen (1987 to Present) Ref. No. 5 [page 56](#)

	<p><b>Note:</b> One size fits all doors. See <a href="#">Service Guide 0001667</a>. See <a href="#">Service Video</a>.</p> <p><b>Kit Includes:</b> (2) Polyethylene splines (large and small) (1) Fiberglass insect screen cloth (1) Wood spacer bar (1) Spline roller</p>	<p><b>Order No.</b> 1274712</p>

# 400 Series Frenchwood® Gliding Doors (1987 to Present)

2-Panel, 4-Panel, and Stationary

## Insect Screens

### Gliding Insect Screen Hardware - 2-Panel

**Note:**

Stone hardware used on sandtone and terratone units.

#### Hardware Package - Insect Screen / Universal / 2 Panel / Interior

	<b>Package Includes:</b> (1) Logo plate (1) Interior pull (1) Exterior pull (2) 6 x 5/8" screws (2) 6 x 1" screws	<b>Finish</b>	<b>Order No.</b>
		Stone	2650504
		White	1997230
		Forest Green	1262834
		Canvas	9071957
		Dark Bronze	9071958

#### Pull - Insect Screen / Universal / 2 and 3 Panel / Interior

		<b>Finish</b>	<b>Order No.</b>
		Stone	1997194
		White	1997306
		Forest Green	1267818
		Canvas	9002044
		Dark Bronze	9021327

#### Pull - Insect Screen / Universal / 2 and 3 Panel / Exterior

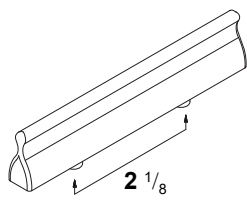
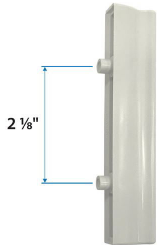
		<b>Finish</b>	<b>Order No.</b>
		Stone	1997195
		White	1997307
		Forest Green	1267819
		Canvas	9002038
		Dark Bronze	9021357

#### Logo Plate with Screws - Insect Screen / Gliding / 2- and 3-Panel

	<b>Finish</b>	<b>Order No.</b>
	Stone	2641206
	White	1997197
	Forest Green	1262841
	Canvas	9002050
	Dark Bronze	9020350

## Insect Screens

Latch with Screws - Gliding Insect Screen / 2-Panel			
	<b>Note:</b> Also used for single retractable screen. Latch attaches to frame side jamb.	<b>Finish</b>	<b>Order No.</b>
		Stone	0924602
		White	2579551
		Forest Green	1267822
		Canvas	By description
		Dark Bronze	By description

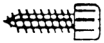
Screw - Insect Screen / Gliding / Lock Fillister / Head		
	<b>Note:</b> Screw for door latch	<b>Order No.</b>
		2573636

Insect Screen Wheel Assembly (1991 to Present) Ref. No. 3 and 6 <a href="#">page 56</a>			
 <p>Upper</p> <p>2 13/16"</p> <p>Lower</p> <p>2 3/8"</p>	<b>Note:</b> Need two (2) per insect screen. See <a href="#">Replacement/Adjustment Video</a> .	<b>Upper</b>	<b>Lower</b>
		1997063	1997310

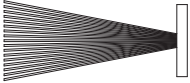
Bug Seal - Insect Screen / Gliding Ref. No. 4 <a href="#">page 56</a> and <a href="#">page 57</a>		
	<b>Note:</b> Order by the foot. Used to replace gliding screen weatherstrip.	<b>Order No.</b>
		2579073

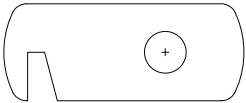
Hook- Insect Screen		
		<b>Order No.</b>
		2579546

# 400 Series Frenchwood® Gliding Doors (1987 to Present)

2-Panel, 4-Panel, and Stationary

## Insect Screens

### Vintage Gliding Insect Screen Hardware - 2-Panel

Door Lock / Gliding Insect Screen / 2-Panel (1987 to 1991)			
	<b>Note:</b> Screw for door latch is part number 2573636 <a href="#">See illustration, page 60</a>	Finish	Order No.
		Stone	1997192
		White	2573866

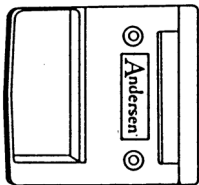
Handle - Insect Screen / Gliding / Interior / 2- and 3-Panel (1982 to 1991)			
	<b>Note:</b> Replace with current insect screen pull <a href="#">page 59</a>	Finish	Order No.
		Stone	N/A
		White	N/A

Spring - Upper / Gliding Insect Screen (1983 to 1991) Ref. No. 3 <a href="#">page 57</a>		
		Order No.
		1997196

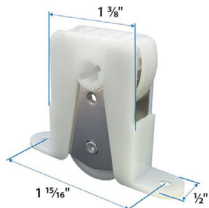
Roller - Insect Screen / Lower (1982 to 1991) Ref. No. 6 <a href="#">page 57</a>		
	<b>Note:</b> Need two (2) per screen. See <a href="#">Replacement Video</a> .	Order No.
		1274104

Screw - Lower Roller / Gliding Insect Screen (1982 to 1991)		
	<b>Note:</b> Need two (2) per roller	Order No.
		3620400

## Insect Screens

### Gliding Insect Screen Hardware - 4-Panel

**Astragal with Hardware - Gliding Insect Screen / 4 Panel** Ref. No. 2 [page 56](#)

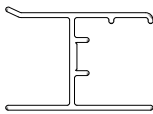
	<b>Note:</b> Includes astragal, pulls, locking lever and screws. See <a href="#">Accessory Guide 0004194</a> .							
	Unit No.	Length	White	Terra-tone®	Sandtone	Forest Green	Canvas	Dark Bronze
	<b>FWG68</b>	<b>77</b>	2565712	2650508	0910302	1262710	9053838	9071953
	<b>FWG611</b>	<b>79 7/8</b>	2565711	2650509	0910303	1262711	9053839	9071954
<b>FWG80</b>	<b>93</b>	2565713	2650510	0910304	1262712	9053840	9071955	

### Hardware Package - Gliding Insect Screen / Astragal / 4-Panel (1987 to Present)

<b>Kit Includes:</b> (2) Four Panel Inside Pull (1) Four Panel Locking Lever (6) Screws #6-20 x 5/8 PH FL See <a href="#">Accessory Guide 0004194</a> .	Finish	Order No.
	White	2565610
	Terratone®	2650506
	Sandtone	
	Forest Green	9061982
	Canvas	9061983
Dark Bronze	9071956	

### Pull with Screws - Inside / Gliding Insect Screen / 4-Panel (1987 to Present)

	<b>Note:</b> Locking lever is not included. See 2573608 below.	
	Finish	Order No.
	Stone	2573610
	White	2573864
	Forest Green	1267821

### Locking Lever - Astragal / Gliding Insect Screen / 4-Panel (1987 to Present)

	Order No.
	2573608

### Bracket - Insect Screen / Head Stop

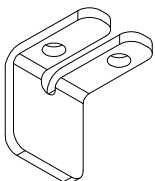
	<b>Note:</b> Use on 4-panel doors	
	Finish	Order No.
	White	2573613
	Stone	2653819

# 400 Series Frenchwood® Gliding Doors (1987 to Present)

2-Panel, 4-Panel, and Stationary

## Insect Screens

### Retractable Insect Screens *(April 2024 - Present)*

**Note:**

See [Installation/Accessory Guide](#) (single).

### Insect Screen - Retractable / **Single** *(April 2024 - Present)*

Unit No.	Size (w x h)	White		Terratone®		Sandtone		Forest Green	
		Left	Right	Left	Right	Left	Right	Left	Right
<b>50</b>	PS510								
	PD5068								
	PD50611								
	PD5080								
<b>60</b>	PD6068	71 1/4 x 79 1/2	9202506	9202507	9202510	9202511	9202514	9202515	
	PD60611								
<b>80</b>	PD6080								
	PD8068								
	PD80611								
	PD8080								

## Insect Screens

### Vintage Retractable Insect Screens (June 2007 - April 2024)

**Note:**  
See [Accessory Guide 0005478](#).

#### Vintage Insect Screen - Retractable (June 2007 - April 2024)

Unit No.		White		Terratone®		Sandtone		Forest Green	
		Left	Right	Left	Right	Left	Right	Left	Right
<b>50</b>	<b>PS510</b>	2517682	1900004	2641756	2641740	0900176	0900160	9056460	9056459
	<b>PD5068</b>	2517673	1900001	2641747	2641737	0900167	0900157	1205660	1205651
	<b>PD50611</b>	2517674	1900002	2641748	2641738	0900168	0900158	1205661	1205652
	<b>PD5080</b>	2517675	1900003	2641749	2641739	0900169	0900159	1205662	1205653
<b>60</b>	<b>PD6068</b>	2517676	1900005	2641750	2641741	0900170	0900161	1205663	1205654
	<b>PD60611</b>	2517677	1900006	2641751	2641742	0900171	0900162	1205664	1205655
<b>80</b>	<b>PD6080</b>	2517678	1900007	2641752	2641743	0900172	0900163	1205665	1205656
	<b>PD8068</b>	2517679	1900008	2641753	2641744	0900173	0900164	1205666	1205657
	<b>PD80611</b>	2517680	1900009	2641754	2641745	0900174	0900165	1205667	1205658
	<b>PD8080</b>	2517681	1900010	2641755	2641746	0900175	0900166	1205668	1205659

### Vintage Retractable Insect Screen Parts (June 2007 - April 2024)

#### Vintage Track - Top / Retractable Insect Screen (June 2007 - April 2024)

	Unit No.	White		Terratone®		Sandtone		Forest Green	
		Left	Right	Left	Right	Left	Right	Left	Right
	<b>PD50</b>	2562467	2562461	2605180	2605174	0916065	0916059	1232868	1232865
	<b>PD60</b>	2562468	2562462	2605181	2605175	0916066	0916060	1232869	1232866
	<b>PD80</b>	2562469	2562463	2605182	2605176	0916067	0916061	1232870	1232867

#### Vintage Track - Bottom / Retractable Insect Screen (June 2007 - April 2024)

	Unit No.	Order No.	
		Left	Right
	<b>PD50</b>	2562464	2562458
	<b>PD60</b>	2562465	2562459
	<b>PD80</b>	2562466	2562460



# 400 Series Frenchwood® Gliding Doors (1987 to Present)

2-Panel, 4-Panel, and Stationary

## Insect Screens

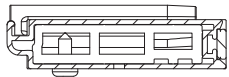
<b>Vintage Slide Bar Assembly - Retractable Insect Screen</b> (June 2007 - April 2024)									
	Unit No.	White		Terratone®		Sandtone		Forest Green	
		Left	Right	Left	Right	Left	Right	Left	Right
	<b>PD68</b>	2562434	2562431	2605168	2605165	0916053	0916050	1232859	1232856
	<b>PD611</b>	2562435	2562432	2605169	2605166	0916054	0916051	1232860	1232857
	<b>PD80</b>	2562436	2562433	2605170	2605167	0916055	0916052	1232861	1232858

<b>Vintage Slide Bar - Retractable Insect Screen</b> (June 2007 - Present)									
	Unit No.	White		Terratone®		Sandtone		Forest Green	
		Left	Right	Left	Right	Left	Right	Left	Right
	<b>PD68</b>	2562425	2562498	2605162	2605186	0916047	0916071	1232853	1232871
	<b>PD611</b>	2562426	2562499	2605163	2605187	0916048	0916072	1232854	1232872
	<b>PD80</b>	2562427	2562501	2605164	2605188	0916049	0916073	1232855	1232873

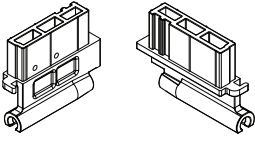
<b>Vintage Slide Body - Retractable Insect Screen</b> (June 2007 - April 2024)				
	Note: A left hand screen will use a left hand slide body on the sill and a right hand slide body on the head.	Color	Left	Right
		<b>White</b>	2562449	2562450
<b>Terratone®</b>	2605171	2605172		
<b>Sandtone</b>	0916056	0916057		
<b>Forest Green</b>	1232862	1232863		

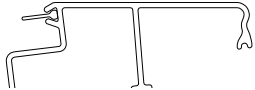
<b>Vintage Track Filler with Sill Sweep - Bottom / Retractable Insect Screen</b> (June 2007 - April 2024)				
			Unit No.	Order No.
			<b>PD50</b>	2562422
			<b>PD60</b>	2562423
			<b>PD80</b>	2562424

## Insect Screens

<b>Vintage Canister Assembly - Retractable Insect Screen</b> (June 2007 - April 2024)									
	Unit No.	White		Terratone®		Sandtone		Forest Green	
		Left	Right	Left	Right	Left	Right	Left	Right
	<b>FWG5068 /6068</b>	2562361	2562355	2605144	2605138	0916029	0916023	1232835	1232829
	<b>FWG50611/ 60611</b>	2562363	2562357	2605146	2605140	0916031	0916025	1232837	1232831
	<b>FWG5080/ 6080</b>	2562365	2562359	2605148	2605142	0916033	0916027	1232839	1232833
	<b>FWG8068</b>	2562362	2562356	2605145	2605139	0916030	0916024	1232836	1232830
	<b>FWG80611</b>	2562364	2562358	2605147	2605141	0916032	0916026	1232838	1232832
	<b>FWG8080</b>	2562366	2562360	2605149	2605143	0916034	0916028	1232840	1232834

<b>Vintage Canister - Retractable Insect Screen</b> (June 2007 - April 2024)					
	Unit No.	White	Terratone®	Sandtone	Forest Green
	<b>PD68</b>	2562349	2605135	0916020	1232826
	<b>PD611</b>	2562350	2605136	0916021	1232827
	<b>PD80</b>	2562351	2605137	0916022	1232828



<b>Vintage End Cap - Canister / Retractable Insect Screen</b> (June 2007 - April 2024)				
	Color	Left	Right	
	<b>White</b>	2562380	2562381	
	<b>Terratone®</b>	2605150	2605151	
	<b>Sandtone</b>	0916035	0916036	
	<b>Forest Green</b>	1232841	1232842	

<b>Vintage Cloth with Core - Retractable Insect Screen</b> (June 2007 - April 2024)				
	Unit No.	Left	Right	
	<b>PD6068</b>	2562403	2562518	
	<b>PD60611</b>	2562404	2562519	
	<b>PD6080</b>	2562405	2562520	
	<b>PD8068</b>	2562406	2562521	
	<b>PD80611</b>	2562407	2562522	
	<b>PD8080</b>	2562408	2562523	

# 400 Series Frenchwood® Gliding Doors (1987 to Present)

2-Panel, 4-Panel, and Stationary

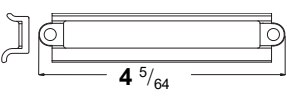
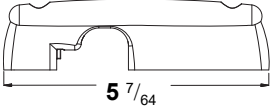
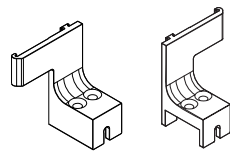
## Insect Screens

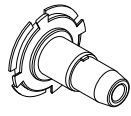
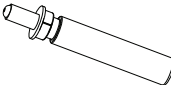
<b>Vintage Handle - Retractable Insect Screen / Inside</b> (June 2007 - April 2024)				
		Color	Unit No.	
		White	2562391	
		Terratone®	2605153	
		Sandtone	0916038	
		Forest Green	1232844	
<b>Vintage Handle - Outside / Retractable Insect Screen</b> (June 2007 - April 2024)				
		Color	Unit No.	
		White	2562390	
		Terratone®	2605152	
		Sandtone	0916037	
		Forest Green	1232843	
<b>Vintage Cassette Retainer - Insect Screen / Retractable</b> (June 2007 - April 2024)				
 <p>Left      Right</p>	<b>Note:</b> The cassette retainer is referred to as cannister brackets in installation instructions. RH unit uses RH bracket on sill and LH bracket on head.	Color	Left	Right
		White	2562401	2562402
		Terratone®	2605157	2605156
		Sandtone	0916041	0916042
		Forest Green	1232847	1232848
<b>Vintage Spline - Insect Screen / Retractable</b> (June 2007 - April 2024)				
				Order No.
				2562452
<b>Vintage Spindle - End Cap / Insect Screen / Retractable</b> (June 2007 - April 2024)				
				Order No.
				2562451
<b>Vintage Dampener - Insect Screen / Retractable</b> (June 2007 - April 2024)				
				White
				2562379
<b>Vintage Magnet - Side Bar / Retractable Insect Screen (Pair)</b> (June 2007 - April 2024)				
<b>Note:</b> Includes one side jamb magnet and one slide bar magnet. Comes as 80 height and cut to size as necessary.			Order No.	
			2573137	

## Insect Screens

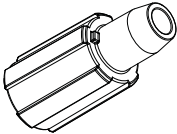
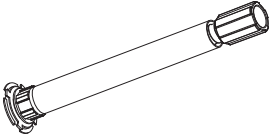
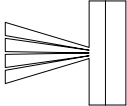
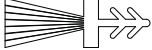
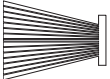
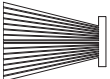
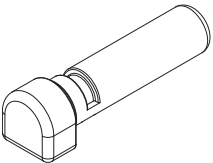
<b>Vintage Spring Tensioner - Insect Screen / Retractable</b> (June 2007 - April 2024)			
		<b>Order No.</b>	
		2562454	
<b>Vintage Spring - Tension - Insect Screen / Retractable</b> (June 2007 - April 2024)			
		<b>Order No.</b>	
		2562456	
<b>Vintage Weatherstrip Pile - Interior Canister - Insect Screen / Retractable</b> (June 2007 - April 2024)			
		<b>Order No.</b>	
		2562497	
<b>Vintage Bug Pile - Barb Spacer / Insect Screen / Retractable</b> (June 2007 - April 2024)			
		<b>Unit No.</b>	<b>Order No.</b>
		PD80	2562340
<b>Vintage Bug Pile - Head and Sill Track Kit / Insect Screen / Retractable</b> (June 2007 - April 2024)			
		<b>Unit No.</b>	<b>Order No.</b>
		PD80	2562341
<b>Vintage Bug Pile - Slide Bar Kit / Insect Screen / Retractable</b> (June 2007 - April 2024)			
		<b>Unit No.</b>	<b>Order No.</b>
		PD80	2562342
<b>Vintage Bumper - Insect Screen / Retractable</b> (June 2007 - April 2024)			
		<b>White</b>	<b>Gray</b>
		2562343	2562344

# 400 Series Frenchwood® Gliding Doors (1987 to Present)

2-Panel, 4-Panel, and Stationary

## Insect Screens

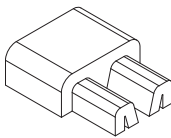
<b>Vintage Bumper - Stop Extension / Insect Screen / Retractable</b> (June 2007 - April 2024)		
		<b>White</b>
		<b>Gray</b>
		2562345
		2562346

<b>Vintage Bushing - Retractable Insect Screen</b> (June 2007 - April 2024)		Order No.
		2562347

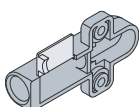
<b>Vintage Bumper Housing - Retractable Insect Screen</b> (June 2007 - April 2024)		
	<b>Note:</b> Installation instructions refer to this part as a "damper".	<b>Color</b>
		<b>White</b>
		<b>Terratone®</b>
		<b>Sandtone</b>
		<b>Forest Green</b>
		<b>Unit No.</b>
		2562395
		2605155
		0916040
		1232846

<b>Vintage Stud/Bolt - Retractable Insect Screen</b> (June 2007 - April 2024)		
		<b>Color</b>
		<b>White</b>
		<b>Terratone®</b>
		<b>Sandtone</b>
		<b>Forest Green</b>
		<b>Unit No.</b>
		2562455
		2605173
		0916058
		1232864

<b>Vintage Hardware Pack - Retractable Insect Screen</b> (June 2007 - April 2024)		
<b>Pack Includes:</b> (1) Bumper - panel stop extension (1) Passive handle (2) Housing dampeners (1) Interior handle (2) Bumpers - finger pinch (2) Tapped studs (1) Retainer cassette, left (1) Retainer cassette, right (5) Screws - 8 -11 x 1 vinyl thread #7 pan head Phillips (4) Screws - 6-20 x .38 sheet metal screws (2) 8-32 1.5 SS PN DH Phillips machine screws (1) 8-32 x .5 SS flat HD Phillips (2) 8-18 x 1.5 SS flat HD Phillips		<b>Color</b>
		<b>White</b>
		<b>Terratone®</b>
		<b>Sandtone</b>
		<b>Forest Green</b>
		<b>Unit No.</b>
		2562392
		2605154
		0916039
		1232845

<b>Vintage Screw - Retractable Insect Screen</b> (June 2007 - April 2024)			
	<b>Description</b>	<b>Color</b>	<b>Order No.</b>
	8-32 x 1/2 PH FL	<b>White</b>	2562414
		<b>Terratone®</b>	2605158
		<b>Sandtone</b>	0916043
		<b>Forest Green</b>	1232849

## Insect Screens

<b>Vintage Screw - Retractable Insect Screen</b> (June 2007 - April 2024)			
	Description	Color	Order No.
	6-20 x 3/8 PH PAN	White	2562417
		Terratone®	2605159
		Sandtone	0916044
		Forest Green	1232850
<b>Vintage Screw - Retractable Insect Screen</b> (June 2007 - April 2024)			
	Description	Color	Order No.
	8 x 1 PH PAN	White	2562419
		Terratone®	2605160
		Sandtone	0916045
		Forest Green	1232851
<b>Vintage Screw - Retractable Insect Screen</b> (June 2007 - April 2024)			
	Description	Color	Order No.
	8-32 x 1 1/2 PH PAN SS	White	2562420
		Terratone®	2605161
		Sandtone	0916046
		Forest Green	1232852
<b>Vintage Screw - Anchor / Sill / Insect Screen / Retractable</b> (June 2007 - April 2024)			
			Gray
			2562339
<b>Vintage Screw - Insect Screen / Retractable</b> (June 2007 - April 2024)			
	Description	Order No.	
	6-32 x 1/2 PH FL TYP F	2562412	
<b>Vintage Screw - Insect Screen / Retractable</b> (June 2007 - April 2024)			
	Description	Order No.	
	8 x 1 1/2 PH FL	2562413	
<b>Vintage Screw - Insect Screen / Retractable</b> (June 2007 - April 2024)			
	Description	Order No.	
	8-18 x 1 1/2 PH PAN SS	2562421	

# 400 Series Frenchwood® Gliding Doors (1987 to Present)

2-Panel, 4-Panel, and Stationary

## Insect Screens

### Retractable Insect Screen Parts / Vintage (Prior to June 2007)

#### Track with Screws - Top / Retractable Insect Screen (August 2003 to May 2007)

	Unit No.	White	Terratone®	Sandtone	Forest Green
	GD50	2573142	2652841	0912647	1262885
	GD60	2573144	2652843	0912649	1262887
	GD80	2573145	2652844	0912650	1262888

#### Track with Screws - Bottom / Retractable Insect Screen (August 2003 to May 2007)

	Unit No.	Order No.
	GD50	2573138
	GD60	2573140
	GD80	2573141

#### Track Filler with Sill Sweep - Bottom / Retractable Insect Screen (August 2003 to May 2007)

	Unit No.	Order No.
	GD50	2573146
	GD60	2573148
	GD80	2573149

#### Retractable Slide Bar - Retractable Insect Screen (August 2003 to May 2007)

	Unit No.	White	Terratone®	Sandtone	Forest Green
	GD68	2573133	2652835	0912642	1262880
	GD611	2573134	2652836	0912643	1262881
	GD80	2573135	2652837	0912644	1262882

#### Canister - Retractable Insect Screen (August 2003 to May 2007)

	Unit No.	White	Terratone®	Sandtone	Forest Green
	GD68	2573130	2652832	0912639	1262877
	GD611	2573131	2652833	0912640	1262878
	GD80	2573132	2652834	0912641	1262879

#### Cloth with Core - Retractable Insect Screen (August 2003 to May 2007)

	Unit No.	Order No.
	GD68	2573151
	GD611	2573152
	GD80	2573153

#### Handle with Screws - Inside / Retractable Insect Screen (August 2003 to May 2007)

	Color	Order No.
	White	2573136
	Terratone®	2652839
	Sandtone	0912646
	Forest Green	1262884

## Insect Screens

<b>Handle with Screws - Outside / Retractable Insect Screen</b> <i>(August 2003 to May 2007)</i>		
	Color	Order No.
	White	2562838
	Terratone®	2652838
	Sandtone	0912645
	Forest Green	1262883

<b>Retainer with Screws - Retractable Insect Screen</b> <i>(August 2003 to May 2007)</i>		
	Color	Order No.
	White	2573154
	Terratone®	2652845
	Sandtone	0912651
	Forest Green	1262889

<b>End Cap - Canister / Retractable Insect Screen</b> <i>(August 2003 to May 2007)</i>		
	Color	Order No.
	White	2573118
	Terratone®	2652831
	Sandtone	0912638
	Forest Green	1262876

<b>Magnet - Slide Bar / Retractable Insect Screen (Pair)</b> <i>(August 2003 to May 2007)</i>	
	Order No.
	2573137

<b>Tension Spring Assembly - Retractable Insect Screen</b> <i>(August 2003 to May 2007)</i>		
	Unit No.	Order No.
		FWG80

<b>Retainer Assembly - Bottom Cassette / Retractable Insect Screen</b> <i>(August 2003 to May 2007)</i>	
	Order No.
	2573155

<b>Screw - Anchor / Retractable Insect Screen</b> <i>(August 2003 to May 2007)</i>	
	Order No.
	2573156

<b>Guide- Insect Screen / Retractable</b> <i>(August 2003 to May 2007)</i>		
	White	Gray
		2573369

<b>End Cap - Slide Bar / Retractable Insect Screen</b> <i>(August 2003 to May 2007)</i>	
	Order No.
	2573123



# 400 Series Frenchwood® Gliding Doors (1987 to Present)

2-Panel, 4-Panel, and Stationary

## Grilles

### Interior Grilles - Custom

**Note:**

See [Accessory Guide 0005285](#). See [Interior Grille Installation Video](#). Grilles include fasteners. Interior removable grilles for custom sizes/patterns are made to order. Product ID label is located on head jamb frame cover.

To order, state:

1. Description of part (Interior Grilles)
2. Quantity
3. Product ID (from product label, see [Service Guide 9051877](#))

### Interior Grilles - Colonial / 7/8" Wood / Natural Interior

**Note:**

**Note:**

See [Accessory Guide 0005285](#). See [Interior Grille Installation Video](#). Grilles include fasteners.

### Interior Grilles - Colonial / 7/8" Wood / Maple

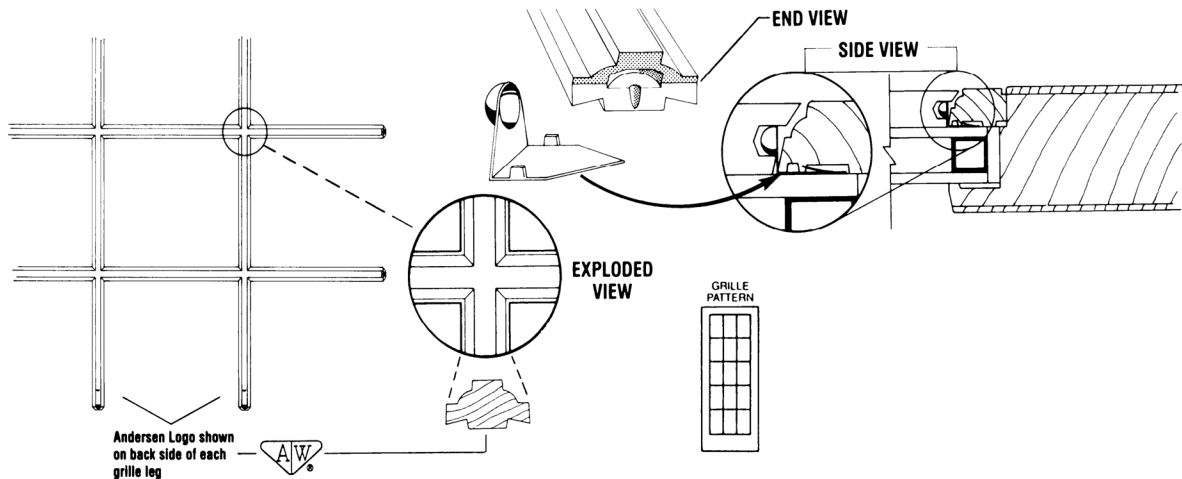

Frenchwood Gliding Door Interior Grilles / Colonial / 7/8" Wood

Unit No.	Dimensions (w x h)	Color/Species						
		Exterior						
		White	Terratone	Sandtone	Forest Green	Canvas	Dark Bronze	
		Interior						
		MAPLE						
26	FWG2668	21 7/16 x 63 7/16	2565419	2650419	0910202	1262513	9134179	9134197
	FWG26611	21 7/16 x 66 5/16	2565405	2650415	0910214	1262516	9134182	9134200
	FWG2680	21 7/16 x 79 7/16	2565430	2650430	0910222	1262519	9134185	9134203
30	FWG3068	27 7/16 x 63 7/16	2565420	2650418	0910204	1262514	9134180	9134198
	FWG30611	27 7/16 x 66 5/16	2565406	2650416	0910215	1262517	9134183	9134201
	FWG3080	27 7/16 x 79 7/16	2565432	2650432	0910224	1262520	9134186	9134204
40	FWG4068	39 7/16 x 63 7/16	2565422	2650420	0910206	1262515	9134181	9134199
	FWG40611	39 7/16 x 66 5/16	2565407	2650417	0910216	1262518	9134184	9134202
	FWG4080	39 7/16 x 79 7/16	2565434	2650434	0910226	1262521	9134187	9134205

# Grilles

## Interior Grilles - Colonial / 7/8" Wood / Oak

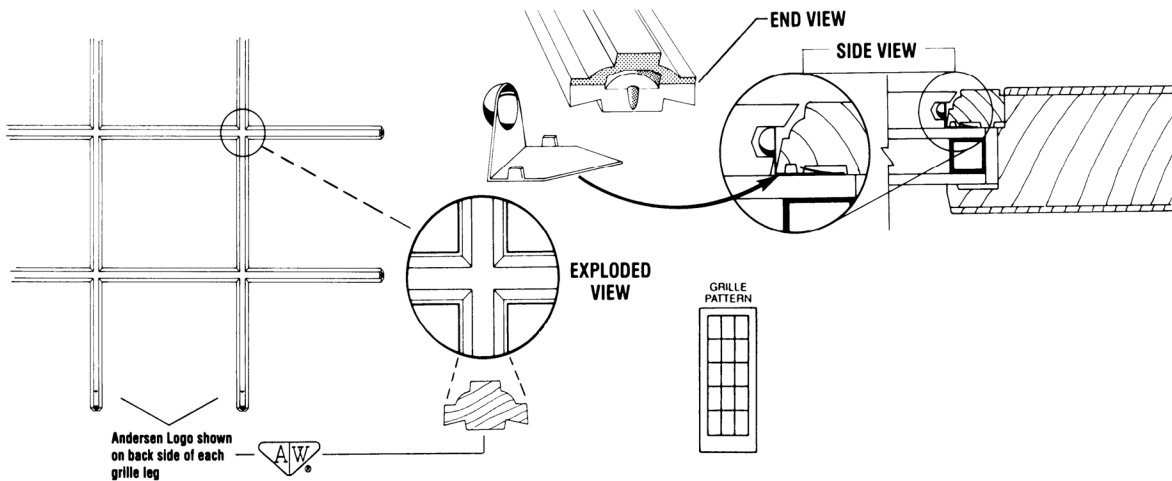

Frenchwood Gliding Door Interior Grilles / Colonial / 7/8" Wood

Unit No.	Dimensions (w x h)	Color/Species						
		Exterior						
		White	Terratone®	Sandtone	Forest Green	Canvas	Dark Bronze	
		Interior						
		<b>OAK</b>						
<b>26</b>	<b>FWG2668</b>	<b>21 7/16 × 63 7/16</b>	2565459	2650445	0910233	1262522	9134188	9134206
	<b>FWG26611</b>	<b>21 7/16 × 66 5/16</b>	2565463	2650449	0910237	1262525	9134191	9134209
	<b>FWG2680</b>	<b>21 7/16 × 79 7/16</b>	2565466	2650452	0910240	1262528	9134194	9134212
<b>30</b>	<b>FWG3068</b>	<b>27 7/16 × 63 7/16</b>	2565461	2650447	0910235	1262523	9134189	9134207
	<b>FWG30611</b>	<b>27 7/16 × 66 5/16</b>	2565464	2650450	0910238	1262526	9134192	9134210
	<b>FWG3080</b>	<b>27 7/16 × 79 7/16</b>	2565467	2650453	0910241	1262529	9134195	9134213
<b>40</b>	<b>FWG4068</b>	<b>39 7/16 × 63 7/16</b>	2565462	2650448	0910236	1262524	9134190	9134208
	<b>FWG40611</b>	<b>39 7/16 × 66 5/16</b>	2565465	2650451	0910239	1262527	9134193	9134211
	<b>FWG4080</b>	<b>39 7/16 × 79 7/16</b>	2565468	2650454	0910242	1262530	9134196	9134214

# 400 Series Frenchwood® Gliding Doors (1987 to Present)

2-Panel, 4-Panel, and Stationary

## Grilles

### Interior Grilles - Colonial / 7/8" Wood / Prefinished Interior

**Note:**

See [Accessory Guide 0005285](#). See [Interior Grille Installation Video](#). Grilles include fasteners. Colors not shown available by description.

### Interior Grilles - Colonial / 7/8" Wood / Prefinished Interior

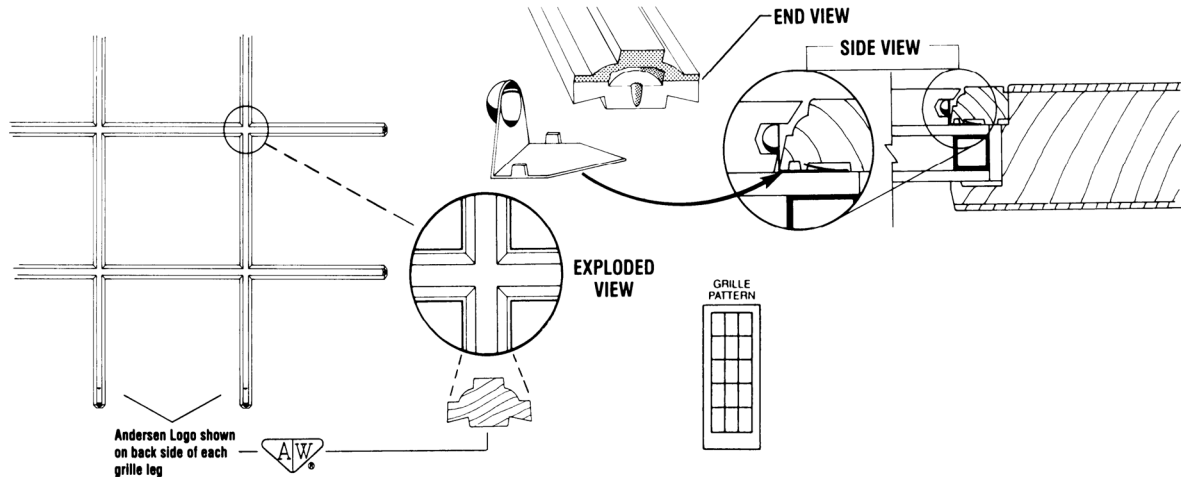

Frenchwood Gliding Door Interior Grilles / Colonial / 7/8" Wood

Unit No.		Dimensions (w x h)	Color/Finish			
			Exterior			
			White	Terratone®	Sandtone	Forest Green
		Interior				
		White	Terratone®	Sandtone	Forest Green	
<b>26</b>	FWG2668	21 <sup>7</sup> / <sub>16</sub> × 63 <sup>7</sup> / <sub>16</sub>	2565469	By description	By description	By description
	FWG26611	21 <sup>7</sup> / <sub>16</sub> × 66 <sup>5</sup> / <sub>16</sub>	2565472	By description	By description	By description
	FWG2680	21 <sup>7</sup> / <sub>16</sub> × 79 <sup>7</sup> / <sub>16</sub>	2565475	By description	By description	By description
<b>30</b>	FWG3068	27 <sup>7</sup> / <sub>16</sub> × 63 <sup>7</sup> / <sub>16</sub>	2565470	By description	By description	By description
	FWG30611	27 <sup>7</sup> / <sub>16</sub> × 66 <sup>5</sup> / <sub>16</sub>	2565473	By description	By description	By description
	FWG3080	27 <sup>7</sup> / <sub>16</sub> × 79 <sup>7</sup> / <sub>16</sub>	2565476	By description	By description	By description
<b>40</b>	FWG4068	39 <sup>7</sup> / <sub>16</sub> × 63 <sup>7</sup> / <sub>16</sub>	2565471	By description	By description	By description
	FWG40611	39 <sup>7</sup> / <sub>16</sub> × 66 <sup>5</sup> / <sub>16</sub>	2565474	By description	By description	By description
	FWG4080	39 <sup>7</sup> / <sub>16</sub> × 79 <sup>7</sup> / <sub>16</sub>	2565477	By description	By description	By description

## Grilles

### Interior Grilles - Prairie A / 7/8" Wood / Natural Interior

**Note:**

See [Accessory Guide 0005285](#). See [Interior Grille Installation Video](#). Grilles include fasteners.

### Interior Grilles - Prairie A / 7/8" Wood / Maple

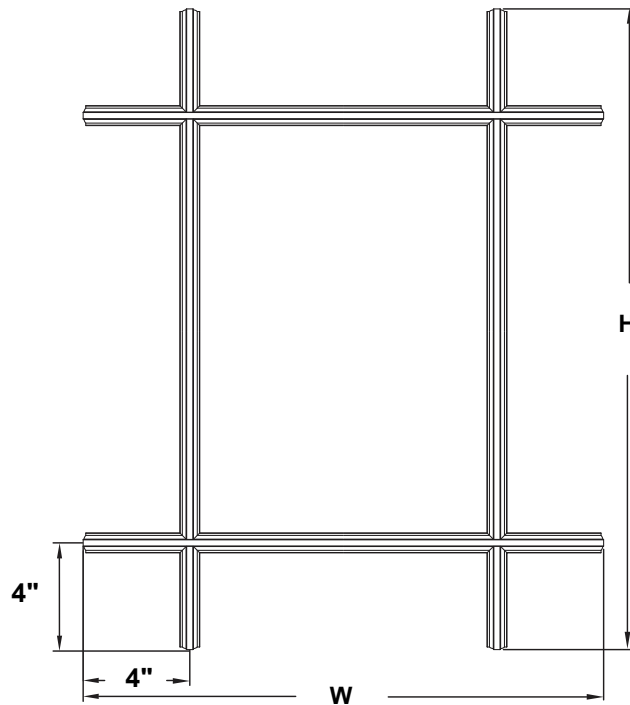

Frenchwood Gliding Door Interior Grilles / Prairie A / 7/8" Wood

Unit No.	Dimensions (w x h)	Color/Species						
		Exterior						
		White	Terratone®	Sandtone	Forest Green	Canvas	Dark Bronze	
		Interior						
		MAPLE						
26	FWG2668	21 7/16 × 63 7/16	2511146	2652603	0930922	1265938	OBD	OBD
	FWG26611	21 7/16 × 66 5/16	2511145	2652602	0930921	1265939	OBD	OBD
	FWG2680	21 7/16 × 79 7/16	2511147	2652604	0930923	1265940	OBD	OBD
30	FWG3068	27 7/16 × 63 7/16	2511149	2652606	0930925	1265941	OBD	OBD
	FWG30611	27 7/16 × 66 5/16	2511148	2652605	0930924	1265942	OBD	OBD
	FWG3080	27 7/16 × 79 7/16	2511150	2652607	0930926	1265943	OBD	OBD
40	FWG4068	39 7/16 × 63 7/16	2511152	2652609	0930928	1265944	OBD	OBD
	FWG40611	39 7/16 × 66 5/16	2511151	2652608	0930927	1265945	OBD	OBD
	FWG4080	39 7/16 × 79 7/16	2511153	2652610	0930929	1265946	OBD	OBD

# 400 Series Frenchwood® Gliding Doors (1987 to Present)

2-Panel, 4-Panel, and Stationary

## Grilles

### Interior Grilles - Prairie A / 7/8" Wood / Oak

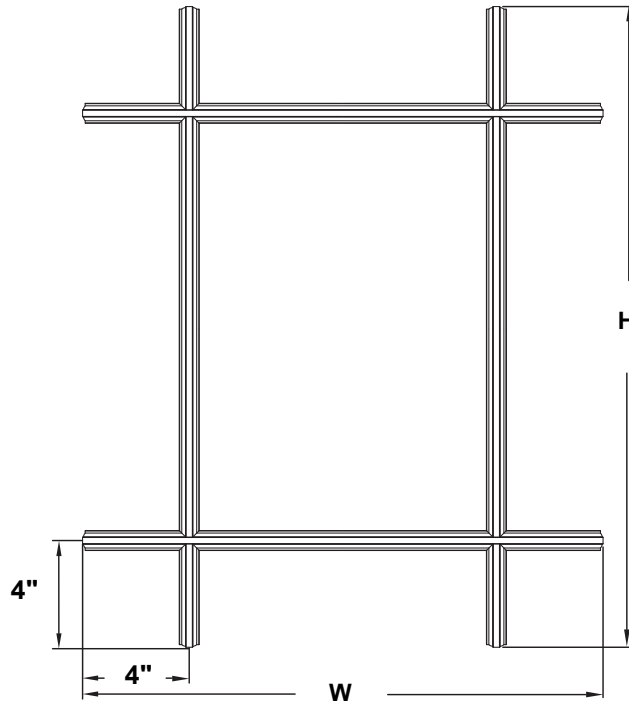

Frenchwood Gliding Door Interior Grilles / Prairie A / 7/8" Wood

Unit No.		Dimensions (w x h)	Color/Species					
			Exterior					
			White	Terratone®	Sandtone	Forest Green	Canvas	Dark Bronze
			Interior OAK					
26	FWG2668	21 7/16 × 63 7/16	2511189	2652646	0930965	1265947	9134381	9134402
	FWG26611	21 7/16 × 66 5/16	2511188	2652645	0930964	1265948	9134380	9134401
	FWG2680	21 7/16 × 79 7/16	2511190	2652647	0930966	1265949	9134382	9134403
30	FWG3068	27 7/16 × 63 7/16	2511192	2652649	0930968	1265950	9134384	9134405
	FWG30611	27 7/16 × 66 5/16	2511191	2652648	0930967	1265951	9134383	9134404
	FWG3080	27 7/16 × 79 7/16	2511193	2652650	0930969	1265952	9134385	9134406
40	FWG4068	39 7/16 × 63 7/16	2511195	2652652	0930971	1265953	9134387	9134408
	FWG40611	39 7/16 × 66 5/16	2511194	2652651	0930970	1265954	9134386	9134407
	FWG4080	39 7/16 × 79 7/16	2511196	2652653	0930972	1265955	9134388	9134409

## Grilles

### Interior Grilles - Prairie A / 7/8" Wood / Prefinished Interior

**Note:**

See [Accessory Guide 0005285](#). See [Interior Grille Installation Video](#). Grilles include fasteners. Colors not shown available by description.

### Interior Grilles - Colonial / 7/8" Wood / Prefinished Interior

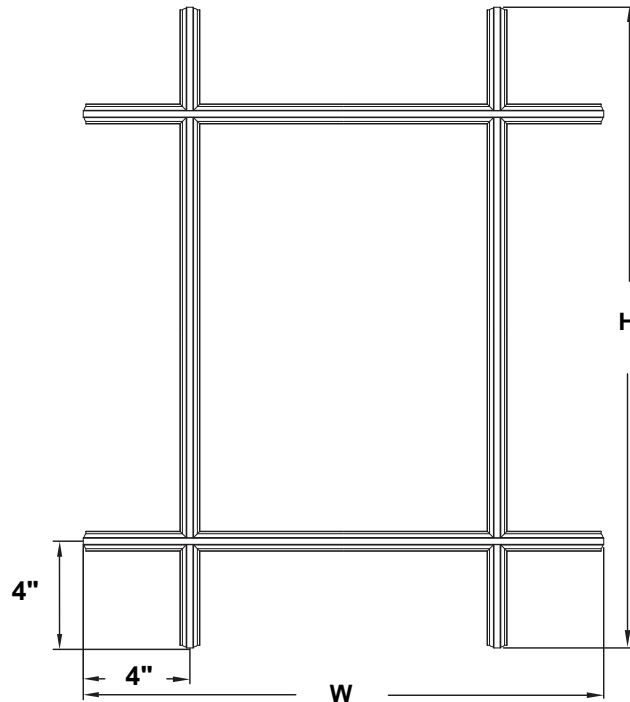



Frenchwood Gliding Door Interior Grilles / Prairie A / 7/8" Wood

Unit No.		Dimensions (w x h)	Color/Finish			
			Exterior			
			White	Terratone®	Sandtone	Forest Green
Unit No.		Dimensions (w x h)	Interior			
			White	Terratone®	Sandtone	Forest Green
			White	Terratone®	Sandtone	Forest Green
<b>26</b>	FWG2668	21 7/16 × 63 7/16	2511103	By description	By description	By description
	FWG26611	21 7/16 × 66 5/16	2511102	By description	By description	By description
	FWG2680	21 7/16 × 79 7/16	2511104	By description	By description	By description
<b>30</b>	FWG3068	27 7/16 × 63 7/16	2511106	By description	By description	By description
	FWG30611	27 7/16 × 66 5/16	2511105	By description	By description	By description
	FWG3080	27 7/16 × 79 7/16	2511107	By description	By description	By description
<b>40</b>	FWG4068	39 7/16 × 63 7/16	2511109	By description	By description	By description
	FWG40611	39 7/16 × 66 5/16	2511108	By description	By description	By description
	FWG4080	39 7/16 × 79 7/16	2511110	By description	By description	By description

# 400 Series Frenchwood® Gliding Doors (1987 to Present)

2-Panel, 4-Panel, and Stationary

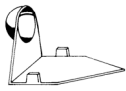
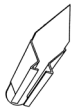
## Grilles

Interior Grille Parts			
<b>Grille Fastener (1989)</b>			
		<b>Order No.</b>	
		1974314	
<b>Notch Grille Fastener - Interior Grille</b>			
		<b>Color</b>	
		<b>White</b>	1974310
		<b>Terratone®</b>	2601210
		<b>Sandtone</b>	8154120
		<b>Forest Green</b>	9046244
		<b>Canvas</b>	9131693
<b>Dark Bronze</b>	9131694		
<b>Grille Installation Tool</b>			
		<b>Order No.</b>	
		9019326	

## Hardware

### Half Trim Set Kits - Interior

**Note:**

Interior half trim sets are available for Newbury®, Covington™, Encino®, Yuma®, Anvers®, Whitmore®, Tribeca®, and Albany Hardware.

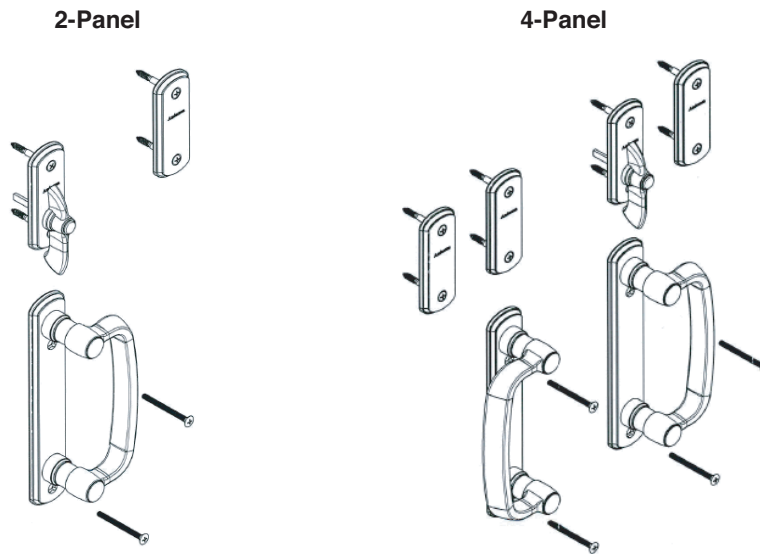

RH Handle, Albany Style Shown

#### Covington™, Newbury®, Encino® and Yuma® Styles

Handle Assembly Parts	2-Panel	4-Panel
Handle, RH Gliding*	1	1
Handle, LH Gliding*	N/A	1
Shank, Gliding	1	3
Plate, Escutcheon, Gliding	1	1
Rubber Washer	2	4
Screw, #10-24 UNC x 1-5/8, PH FL, MACH	2	4
<b>Other Parts</b>		
Screw, #8 x 2" Oval Head Threaded Bolt	2	4
Retain Ring	1	1
Wave Washer	1	1
Plate, Thumb Latch Escutcheon	1	1
Tail Piece	1	1
Lever, Thumb Latch	1	1
Pin	1	1
Ball Bearing - Delrin	3	3
Screw, #8 x 1 3/4" Oval Head Screw	2	4
Plate Trim	1	2
Plate, Escutcheon Cover	N/A	1

\* All 2-panel kits contain a RH handle/escutcheon assembly. Convert RH handle assembly for LH installations.



## 400 Series Frenchwood® Gliding Doors (1987 to Present)

*2-Panel, 4-Panel, and Stationary*

### Hardware

<b>Whitmore®, Anvers®, and Albany Styles</b>		
<b>Handle Assembly Parts</b>	<b>2-Panel</b>	<b>4-Panel</b>
Handle, RH Gliding*	1	1
Handle, LH Gliding*	N/A	1
Plate, Escutcheon, Gliding	1	2
Rubber Washer	2	4
Screw, #8 x 2" Oval Head Threaded Bolt	2	4
<b>Other Parts</b>		
Retain Ring	1	1
Wave Washer	1	1
Plate, Thumb Latch Escutcheon	1	1
Tail Piece	1	1
Lever, Thumb Latch	1	1
Pin	1	1
Ball Bearing - Delrin	3	3
Screw, #8 x 1 3/4" Oval Head Screw	2	4
Plate, Escutcheon Cover	N/A	3
* All 2-panel kits contain a RH handle/escutcheon assembly. Convert RH handle assembly for LH installations.		

## Hardware

### Half Trim Set Kits - Exterior

**Note:**

Exterior half trim sets are available for Newbury®, Covington™, Encino®, Yuma®, Anvers®, Whitmore®, Tribeca®, and Albany Hardware. Half trim set kit does **not** include [multi-point lock/latch receiver](#).

2-Panel



4-Panel

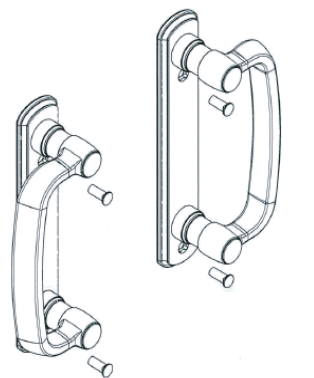

RH Handle, Albany Style Shown

### Newbury®, Covington™, Encino®, Yuma®, Anvers®, Whitmore®, and Albany Styles

**Note:**

Tribeca® exterior kit does not include tapped studs.

Sets include:	2-Panel	4-Panel
<b>Handle Assembly Parts</b>		
Handle, RH Gliding*	1	1
Handle, LH Gliding*	N/A	1
Shank, Gliding	2	4
Plate, Escutcheon, Gliding	1	2
Rubber Washer	2	4
Screw, #10-24 UNC x 1-5/8, PH FL MACH	2	4
Stud Tapped	2	4
<b>Other Parts</b>		
9/64, Allen Wrench	N/A	1

\* All 2-panel kits contain a RH handle/escutcheon assembly. Convert RH handle assembly for LH installations.

# 400 Series Frenchwood® Gliding Doors (1987 to Present)

2-Panel, 4-Panel, and Stationary

## Hardware

### Hardware - Tribeca®

**Note:**

See [Accessory Guide 0005414](#). Trim set does **not** include [reachout lock/latch receiver](#). Consider ordering a new reachout lock/latch receiver kit when replacing your trim set.

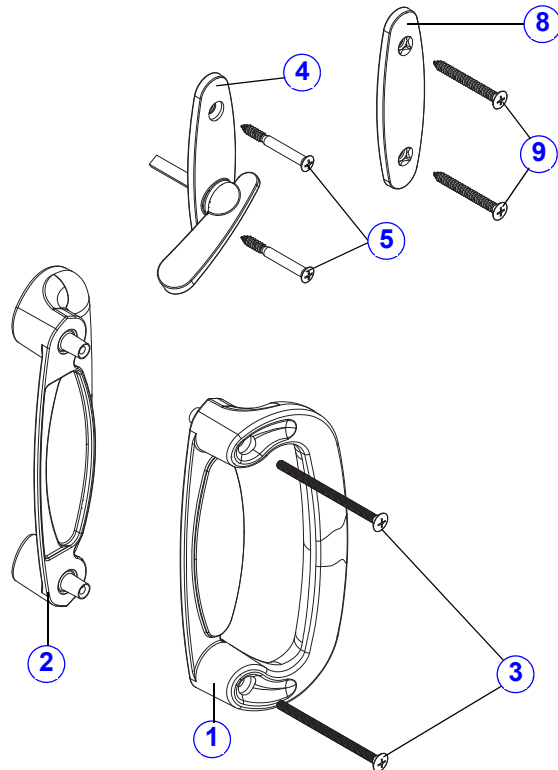

1. [Interior Handle](#)
2. [Exterior Handle](#)
3. [#8 x 2 11/16" Oval Head Bolt](#)
4. [Latch Lever](#)
5. [#10-16 X 1-3/4", PH W/#8 Oval Head, Type AB Screw](#)
8. [Cover Plate](#)
9. [#10 x 1 3/4" Oval Head Wood Screw](#)

#### Trim Set Hardware - Tribeca® / Interior and Exterior

	Panels	Stone	White	Black
	2	2565696	2565694	9184666
	4	2565697	2565695	9184667

#### Trim Set Hardware - Tribeca® / Interior

	Panels	Stone	White	Black
	2	2562078	2562076	9184664
	4	2562079	2562077	9184665

#### Trim Set Hardware - Tribeca® / Exterior

	Panels	Stone	White	Black
	2	2562034	2562032	9184662
	4	2562035	2562033	9184663

## Hardware

Handle - Tribeca® / Interior Ref. No. 1 <a href="#">page 84</a>		
<b>Note:</b> Handles are sold assembled with escutcheon plates.	Finish	Order No.
	Stone	2573603
	White	2573602
	Black	9184677
Handle - Tribeca® / Exterior Ref. No. 2 <a href="#">page 84</a>		
<b>Note:</b> Handles are sold assembled with escutcheon plates.	Finish	Order No.
	Stone	2573605
	White	2573604
	Black	9184678
Thumb Latch/Latch Lever - Tribeca® / Interior Lock Ref No.4 <a href="#">page 84</a>		
<b>Note:</b> Ships with fasteners. See <a href="#">Latch Lever Replacement Video</a> .	Finish	Order No.
	Stone	2573611
	White	2573609
	Black	9184679
Cover Plate - Tribeca® Ref. No.8 <a href="#">page 84</a>		
<b>Note:</b> Ships with fasteners.	Finish	Order No.
	Stone	2573623
	White	2573621
	Black	9184680

Screw Package - Trim Set / Tribeca® (1999 to 2005)		
<b>Note:</b> Used with Metro/Tribeca style hardware offered from 1999-2005.	Finish	Order No.
	Stone	2579769
<b>Package Includes:</b> (2) Screws, #10 x 1 3/4" Sheet metal (2) Screws, #8 x 2" Machine (2) Screws, #10 x 2 1/2" Machine (2) Screws, #8 x 13/16" Machine (1) Screw, #10 x 3" Flathead sheet metal	White	2579768

Lock Assembly with Keys - Tribeca®					
<b>Note:</b> Lock assemblies will have two (2) cut keys and two (2) 2 1/4" bolts <a href="#">page 112</a> . Order keyed alike exterior locks in quantities needed. See <a href="#">Accessory Guide 0005196</a> . See <a href="#">Installation Video</a> .					
	Finish	Lock Assembly		Keyed Alike	
		Left	Right	Left	Right
	Stone	2573069	2573079	9056179	9056181
	White	2573068	2573078	9056178	9056180
Black	9184674	9184675	9184693	9184694	

## 400 Series Frenchwood® Gliding Doors (1987 to Present)

*2-Panel, 4-Panel, and Stationary*

### Hardware

<b>Lock Assembly with Keys - Tribeca® / Exterior/ Keyed Alike Right-Hand and Left-Hand</b>		
<b>Note:</b> Contains 1 right hand and 1 left hand assembly	<b>Finish</b>	<b>Order No.</b>
	Stone	9056204
	White	9056205
	Black	9184695

<b>Key Cylinder - Tribeca®</b>
<b>Note:</b> Tribeca® lock assembly has used a 6 pin cylinder since January of 2004. Glass dates do not always represent the vintage of the lock assembly or the replacement key cylinder needed. 6 pin replacement cylinder are found on <a href="#">page 112</a> . 5 pin replacement cylinder are found on <a href="#">page 115</a> .

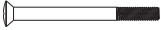
<b>Bolt Package for Exterior Lock - Tribeca® (Pair) (2005 to Present)</b>			
		<b>Length</b>	<b>Finish</b>
		2 1/4"	Stone
		2 1/4"	White
			<b>Order No.</b>
			2573648
			2573647

<b>Lock Housing</b>		
<b>Note:</b> Replace with entire exterior lock assembly.	<b>Stone</b>	<b>White</b>
	N/A	

## Hardware

### Hardware - Anvers®

**Note:**

See [Accessory Guide 0005414](#). Trim set does **not** include [reachout lock/latch receiver](#). Consider ordering a new reachout lock/latch receiver kit when replacing your trim set.

\*Oil Rubbed Bronze and Satin Nickel part numbers can be used as replacement for trim sets ordered through Home Depot.

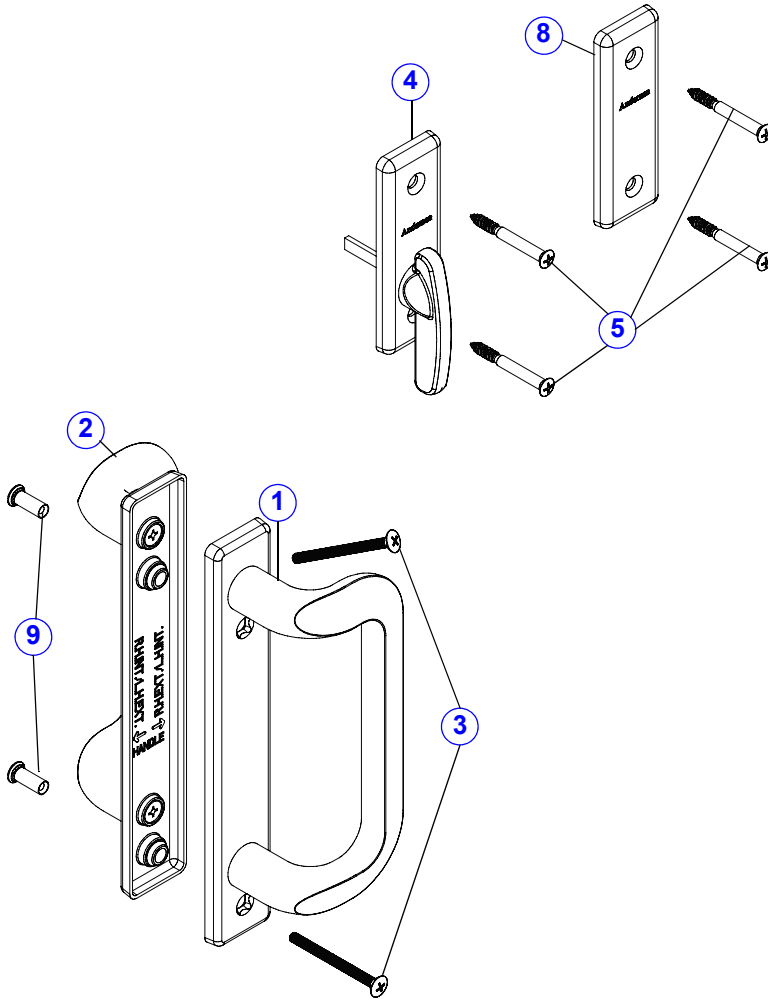

1. [Handle RH Interior/LH Exterior](#)
2. [Handle LH Interior/RH Exterior](#)
3. [#8 x 2" Oval Head Threaded Bolt](#)
4. [Latch Lever](#)
5. [#8 x 1 3/4" Oval Head Screw](#)
8. [Cover Plate](#)
9. [Mounting Stud](#)

Anvers® Gliding Patio Door Hardware - 2-Panel Trim Set

### Trim Set Hardware - Anvers® / Interior and Exterior

Panels	Finish	Order No.
2	Bright Brass	2565539
	Oil Rubbed Bronze*	2565543
	Satin Nickel*	2565541
4	Bright Brass	2565540
	Oil Rubbed Bronze	2565544
	Satin Nickel	2565542

# 400 Series Frenchwood® Gliding Doors (1987 to Present)

2-Panel, 4-Panel, and Stationary

## Hardware

Trim Set Hardware - Anvers® / Interior			
	Panels	Finish	Order No.
	2	Bright Brass	2562092
		Oil Rubbed Bronze	2562103
		Satin Nickel	2562109
	4	Bright Brass	2562093
		Oil Rubbed Bronze	2562112
		Satin Nickel	2562118

Trim Set Hardware - Anvers® / Exterior			
	Panels	Finish	Order No.
	2	Bright Brass	2562048
		Oil Rubbed Bronze	2562066
		Satin Nickel	2562072
	4	Bright Brass	2562049
		Oil Rubbed Bronze	2562067
		Satin Nickel	2562073

Handle - Anvers® Ref. No. 1 & 2 <a href="#">page 87</a>			
<b>Note:</b> Handles are sold assembled with escutcheon plates.	Finish	Left Interior/ Right Exterior	Right Interior/ Left Exterior
	Bright Brass	2573219	2573220
	Oil Rubbed Bronze	2573221	2573222
	Satin Nickel	2573223	2573224

Thumb Latch / Latch Lever - Anvers® / Interior Lock Ref. No. 4 <a href="#">page 87</a>		
<b>Note:</b> Ships with fasteners. See <a href="#">Latch Lever Replacement Video</a> .	Finish	Order No.
	Bright Brass	2573239
	Oil Rubbed Bronze	2573240
	Satin Nickel	2573241

Cover Plate with Screws - Anvers® Ref. No. 8 <a href="#">page 87</a>		
<b>Note:</b> Ships with fasteners. Use one cover plate on two-panel units; three cover plates on four-panel units.	Finish	Order No.
	Bright Brass	2573249
	Oil Rubbed Bronze	2573250
	Satin Nickel	2573251

Screw Package - Trim Set / Anvers®
<b>Note:</b> Screw package is shown in the shared hardware section <a href="#">page 110</a> .

## Hardware

### Lock Assembly with Keys - Anvers®

**Note:**

Lock assemblies will have two (2) cut keys and two (2) 2 1/4" bolts [page 112](#).

Order keyed alike exterior locks in quantities needed.

See [Accessory Guide 0005196](#). See [Installation Video](#).

	<b>Finish</b>	<b>Lock Assembly</b>		<b>Keyed Alike</b>		
		<b>Left</b>	<b>Right</b>	<b>Left</b>	<b>Right</b>	
		Bright Brass	2573269	2573090	9056172	9056175
		Oil Rubbed Bronze	2573270	2573091	9056173	9056176
	Satin Nickel	2573271	2573092	9056174	9056177	

### Lock Assembly with Keys - Anvers® / Exterior/ Keyed Alike Right-Hand and Left-Hand

**Note:**

Contains 1 right hand and 1 left hand assembly

<b>Finish</b>	<b>Order No.</b>
Bright Brass	9056201
Oil Rubbed Bronze	9056202
Satin Nickel	9056203

### Key Cylinder - Anvers®

**Note:**

Anvers® lock assembly uses a 6 pin replacement cylinder are found on [page 112](#).

### Bolt Package - Anvers® / Exterior Lock

**Note:**

Bolt package is included in the current lock parts section [page 112](#).

### Lock Housing - Anvers® / Exterior

**Note:**

Replace with complete exterior lock assembly.

<b>Finish</b>	<b>Order No.</b>
Bright Brass	N/A
Oil Rubbed Bronze	N/A
Satin Nickel	N/A



# 400 Series Frenchwood® Gliding Doors (1987 to Present)

2-Panel, 4-Panel, and Stationary

## Hardware

### Hardware - Newbury®

**Note:** See [Accessory Guide 0005414](#). Trim set does **not** include [reachout lock/latch receiver](#). Consider ordering a new reachout lock/latch receiver kit when replacing your trim set.

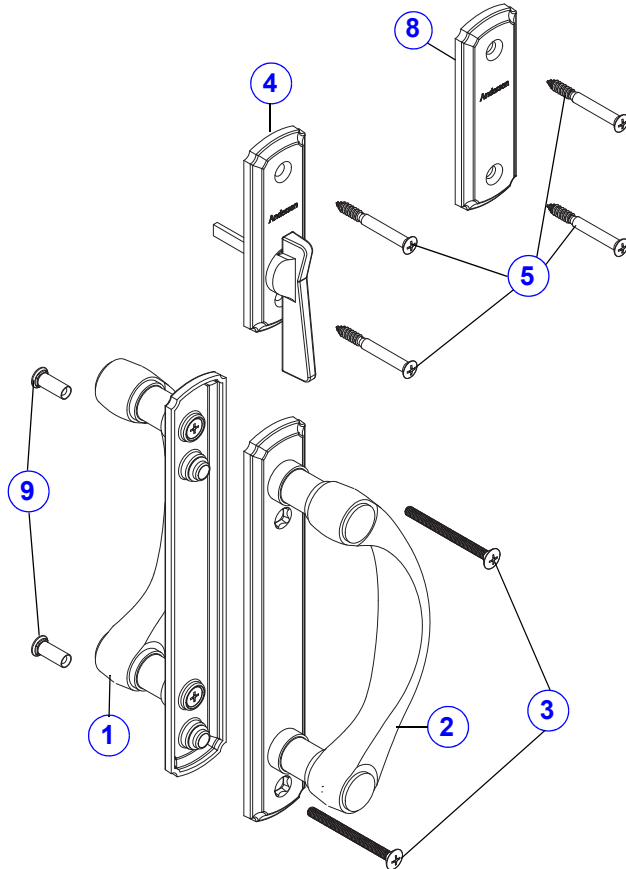

1. [Handle RH Interior/LH Exterior](#)
2. [Handle LH Interior/RH Exterior](#)
3. [#8 x 2" Oval Head Threaded Bolt](#)
4. [Latch Lever](#)
5. [#8 x 1 3/4" Oval Head Screw](#)
8. [Cover Plate](#)
9. [Mounting Stud](#)

**Newbury® Gliding Patio Door Hardware - Panel Trim Set**

### Trim Set Hardware - Newbury® / Interior and Exterior

	Panels	Finish	Order No.
	2	Antique Brass	2565686
		Brushed Chrome	2579748
		Chrome	2565688
		H.P. Brass	2565684
		Oil Rubbed Bronze	2579744
		Satin Nickel	2579435
	4	Antique Brass	2565687
		Brushed Chrome	2579749
		Chrome	2565689
		H.P. Brass	2565685
		Oil Rubbed Bronze	2579745
		Satin Nickel	2579436

## Hardware

Trim Set Hardware - Newbury® / Interior			
	Panels	Finish	Order No.
	2	Antique Brass	2562082
		Brushed Chrome	N/A
		Chrome	N/A
		H.P. Brass	2562080
		Oil Rubbed Bronze	2562088
		Satin Nickel	2562090
	4	Antique Brass	2562081
		Brushed Chrome	N/A
		Chrome	N/A
		H.P. Brass	2562083
		Oil Rubbed Bronze	2562089
		Satin Nickel	2562091

Trim Set Hardware - Newbury® / 2-Panel / Exterior			
	Panels	Finish	Order No.
	2	Antique Brass	2562036
		Brushed Chrome	N/A
		Chrome	N/A
		H.P. Brass	2562038
		Oil Rubbed Bronze	2562044
		Satin Nickel	2562046
	4	Antique Brass	2562037
		Brushed Chrome	N/A
		Chrome	N/A
		H.P. Brass	2562039
		Oil Rubbed Bronze	2562045
		Satin Nickel	2562047

Handle - Newbury® Ref. No. 1 and 2 <a href="#">page 90</a>			
<b>Note:</b> Handles are sold assembled with escutcheon plates. Current Antique Brass finish may not match previous vintages of Antique Brass.	Finish	Left Interior/ Right Exterior	Right Interior/ Left Exterior
	Antique Brass	2573593	2573596
	Brushed Chrome	N/A	2579944
	Chrome	N/A	2573595
	H.P. Brass	2573594	2573597
	Oil Rubbed Bronze	2579941	2579943
	Satin Nickel	2579433	2579434

## 400 Series Frenchwood® Gliding Doors (1987 to Present)

*2-Panel, 4-Panel, and Stationary*

### Hardware

<b>Thumb Latch - Newbury® / Inside Lock</b> Ref. No. 4 <a href="#">page 90</a>		
<b>Note:</b> Ships with fasteners. See <a href="#">Latch Lever Replacement Video</a> .	<b>Finish</b>	<b>Order No.</b>
	Antique Brass	2573599
	Brushed Chrome	2579950
	Chrome	2573598
	H.P. Brass	2573601
	Oil Rubbed Bronze	2579949
	Satin Nickel	2579425
<b>Cover Plate with Screws - Newbury® / 4-Panel</b> Ref. No. 8 <a href="#">page 90</a>		
<b>Note:</b> Ships with fasteners. Use one cover plate on two-panel units; three cover plates on four-panel units.	<b>Finish</b>	<b>Order No.</b>
	Antique Brass	2573507
	Brushed Chrome	2579954
	Chrome	2573509
	H.P. Brass	2573543
	Oil Rubbed Bronze	2579953
	Satin Nickel	2579432
<b>Screw Package - Trim Set / Newbury®</b>		
<b>Note:</b> Screw package is shown in the shared hardware section <a href="#">page 110</a> .		

## Hardware

### Lock Assembly with Keys - Newbury®

**Note:**

Lock assemblies will have two (2) cut keys and two (2) 2 1/4" bolts [page 112](#).

Order keyed alike exterior locks in quantities needed.

See [Accessory Guide 0005196](#). See [Installation Video](#)..

	Finish	Lock Assembly		Keyed Alike	
		Left	Right	Left	Right
	Antique Brass	2573071	2573081	9056152	9056158
	Brushed Chrome	2573075	2573085	9056153	9056159
	Chrome	2573072	2573082	9056154	9056160
	H.P. Brass	2573070	2573080	9056155	9056161
	Oil Rubbed Bronze	2573074	2573084	9056156	9056162
Satin Nickel	2573073	2573083	9056157	9056163	

### Lock Assembly with Keys - Newbury®/ Exterior/ Keyed Alike Right-Hand and Left-Hand

**Note:**

Contains 1 right hand and 1 left hand assembly

Finish	Order No.
Antique Brass	9056206
Brushed Chrome	9056207
Chrome	9056208
H.P. Brass	9056209
Oil Rubbed Bronze	9056210
Satin Nickel	9056211

### Key Cylinder - Newbury®

**Note:**

Newbury® lock assembly has used a 6 pin cylinder since January of 2004.

Glass dates do not always represent the vintage of the lock assembly or the replacement key cylinder needed.

6 pin replacement cylinder are found on [page 112](#).

5 pin replacement cylinder are found on [page 115](#).

### Bolt Package - Newbury® / Exterior Lock

**Note:**

Bolt package is included in the shared lock parts section [page 112](#).

### Lock Housing - Newbury® / Exterior

**Note:**

Replace with complete exterior lock assembly.

Finish	Order No.
Antique Brass	N/A
Brushed Chrome	
Chrome	
H.P. Brass	
Oil Rubbed Bronze	
Satin Nickel	

# 400 Series Frenchwood® Gliding Doors (1987 to Present)

2-Panel, 4-Panel, and Stationary

## Hardware

### Hardware - Covington™

**Note:** See [Accessory Guide 0005414](#). Trim set does not include [reachout lock/latch receiver](#). Consider ordering a new reachout lock/latch receiver kit when replacing your trim set. Newbury is warranty replacement for items N/A.

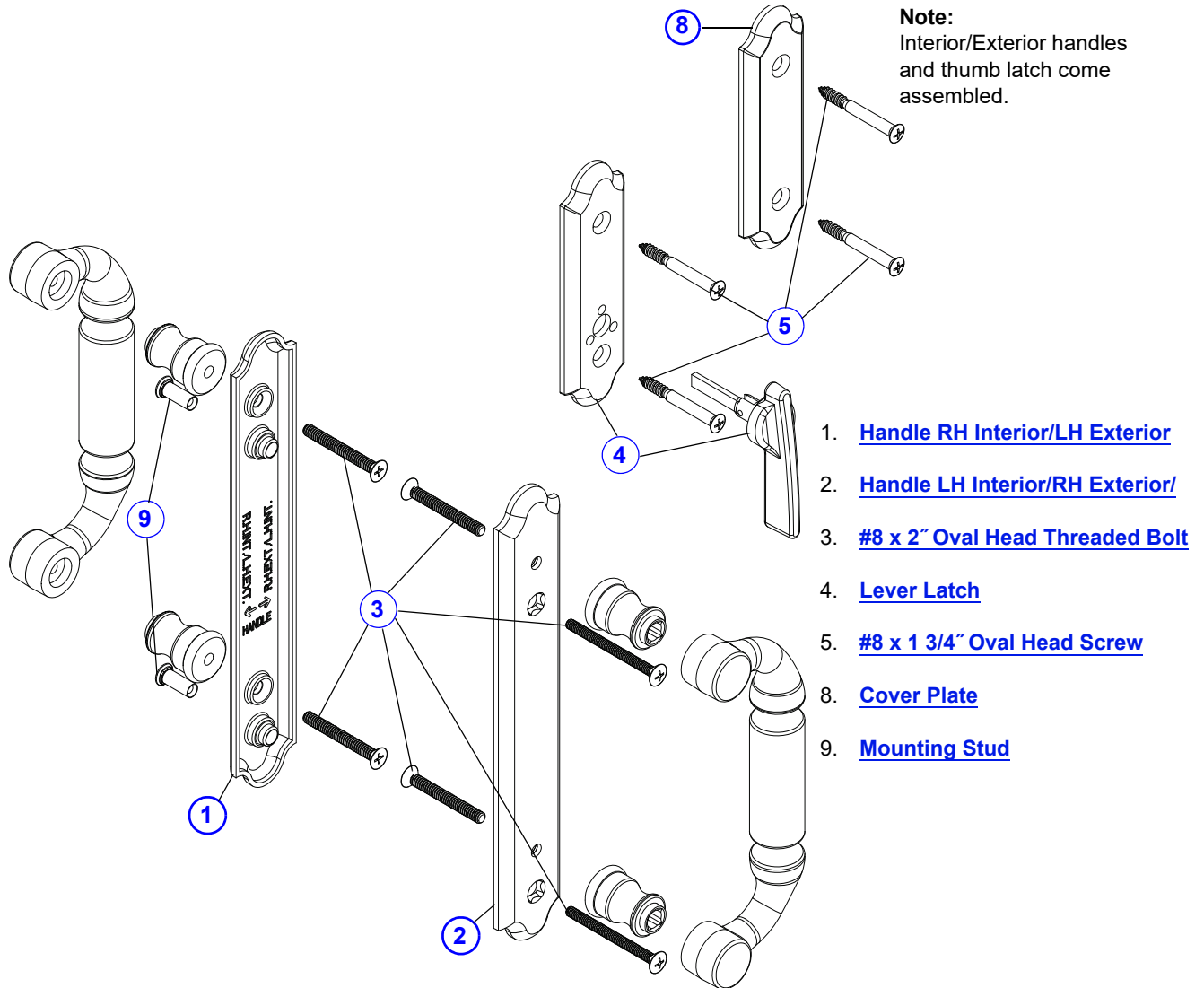

Covington™ Gliding Patio Door Hardware - 2-Panel Trim Set

### Trim Set Hardware - Covington™ / Interior and Exterior

	Panels	Finish	Order No.
	2	Antique Brass	2565563
		Bright Brass	2565561
		Oil Rubbed Bronze	2565567
	4	Antique Brass	2565564
		Bright Brass	2565562
		Oil Rubbed Bronze	2565568

## Hardware

Trim Set Hardware - Covington™ / Interior			
	Panels	Finish	Order No.
	2	Antique Brass	N/A
		Bright Brass	N/A
		Oil Rubbed Bronze	N/A
	4	Antique Brass	N/A
		Bright Brass	N/A
		Oil Rubbed Bronze	N/A

Trim Set Hardware - Covington™ / Exterior			
	Panels	Finish	Order No.
	2	Antique Brass	N/A
		Bright Brass	N/A
		Oil Rubbed Bronze	N/A
	4	Antique Brass	N/A
		Bright Brass	N/A
		Oil Rubbed Bronze	N/A

Handle - Covington™ Ref. No. 1 & 2 <a href="#">page 94</a>			
Note: Handles are sold assembled with escutcheon plates.	Finish	Left Interior/ Right Exterior	Right Interior/ Left Exterior
	Antique Brass	N/A	2573234
	Bright Brass	2573235	2573236
	Oil Rubbed Bronze	N/A	2573238

Thumb Latch/Latch Lever - Covington™ / Inside Lock Ref. No. 4 <a href="#">page 94</a>		
Note: Ships with fasteners. See <a href="#">Latch Lever Replacement Video</a> .	Finish	Order No.
	Antique Brass	2573246
	Bright Brass	2573247
	Oil Rubbed Bronze	2573248

Cover Plate with Screws - Covington™ / 4-Panel Ref. No. 8 <a href="#">page 94</a>		
Note: Ships with fasteners. Use one cover plate on two-panel units; three cover plates on four-panel units.	Finish	Order No.
	Antique Brass	2573256
	Bright Brass	2573257
	Oil Rubbed Bronze	2573258

Screw Package - Trim Set / Covington™
Note: Screw package is shown in the shared hardware section <a href="#">page 110</a> .

# 400 Series Frenchwood® Gliding Doors (1987 to Present)

2-Panel, 4-Panel, and Stationary

## Hardware

### Lock Assembly with Keys - Covington™

**Note:**

Lock assemblies will have two (2) cut keys and two (2) 2 1/4" bolts [page 112](#).

Order keyed alike exterior locks in quantities needed.

See [Accessory Guide 0005196](#). See [Installation Video](#).

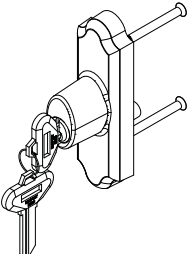
	Finish	Lock Assembly		Keyed Alike	
		Left	Right	Left	Right
	Antique Brass	2573276	2573097	9056149	9056146
	Bright Brass	2573277	2573098	9056150	9056147
Oil Rubbed Bronze	2573278	2573099	9056151	9056148	

### Lock Assembly with Keys - Covington™ / Exterior/ Keyed Alike Right-Hand and Left-Hand

**Note:**

Contains 1 right hand and 1 left hand assembly

Finish	Order No.
Antique Brass	9056198
Bright Brass	9056199
Oil Rubbed Bronze	9056200

### Key Cylinder - Covington™

**Note:**

Covington™ lock assembly uses a 6 pin replacement cylinder are found on [page 112](#).

### Bolt Package - Covington™ / Exterior Lock

**Note:**

Bolt package is included in the shared lock parts section [page 112](#).

### Lock Housing - Covington™ / Exterior

**Note:**

Replace with complete exterior lock assembly.

Finish	Order No.
Antique Brass	N/A
Bright Brass	
Oil Rubbed Bronze	

## Hardware

### Hardware - Whitmore®

**Note:**

See [Accessory Guide 0005414](#). Trim set does **not** include [reachout lock/latch receiver](#). Consider ordering a new reachout lock/latch receiver kit when replacing your trim set. Newbury is warranty replacement for items N/A.

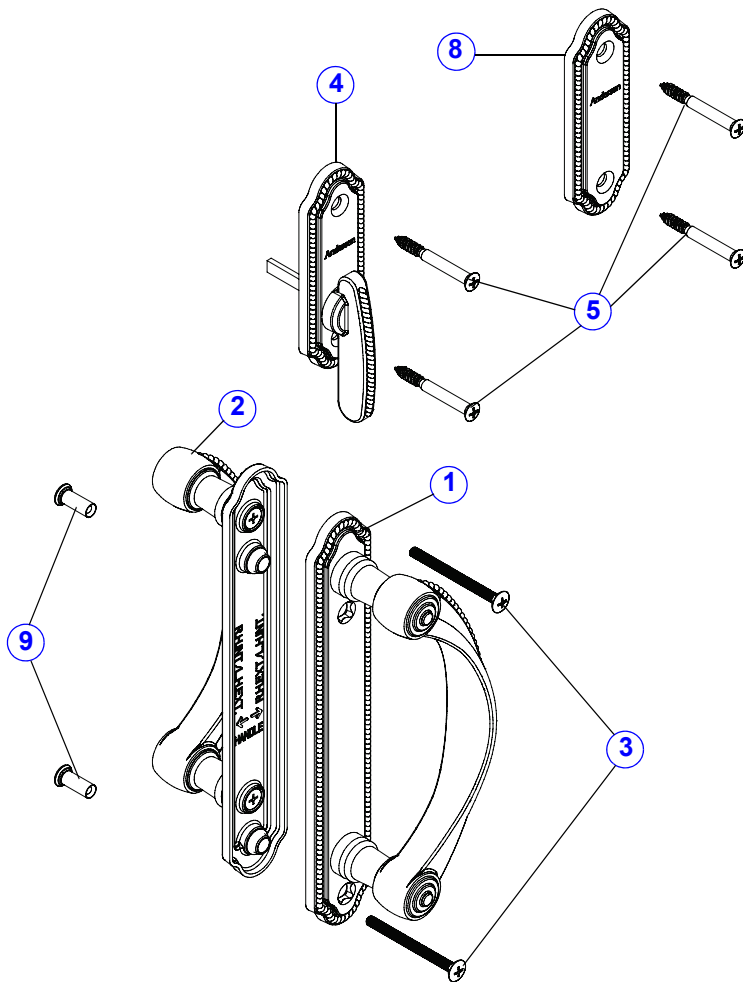

1. [Handle RH Interior/LH Exterior](#)
2. [Handle LH Interior/RH Exterior](#)
3. [#8 x 2" Oval Head Threaded Bolt](#)
4. [Latch Lever](#)
5. [#8 x 1 3/4" Oval Head Screw](#)
8. [Cover Plate](#)
9. [Mounting Stud](#)

**Whitmore® Gliding Patio Door Hardware - 2-Panel Trim Set**

### Trim Set Hardware - Whitmore®/ Interior and Exterior

	Panels	Finish	Order No.
	2	Antique Brass	2565549
		Bright Brass	2565545
		Oil Rubbed Bronze	2565551
		Satin Nickel	2565547
	4	Antique Brass	2565550
		Bright Brass	2565546
		Oil Rubbed Bronze	2565552
		Satin Nickel	2565548



# 400 Series Frenchwood® Gliding Doors (1987 to Present)

2-Panel, 4-Panel, and Stationary

## Hardware

Trim Set Hardware - Whitmore® / Interior			
	Panels	Finish	Order No.
	2	Antique Brass	N/A
		Bright Brass	N/A
		Oil Rubbed Bronze	N/A
		Satin Nickel	N/A
	4	Antique Brass	N/A
		Bright Brass	N/A
		Oil Rubbed Bronze	N/A
		Satin Nickel	N/A

Trim Set Hardware - Whitmore® / Exterior			
	Panels	Finish	Order No.
	2	Antique Brass	N/A
		Bright Brass	N/A
		Oil Rubbed Bronze	N/A
		Satin Nickel	N/A
	4	Antique Brass	N/A
		Bright Brass	N/A
		Oil Rubbed Bronze	N/A
		Satin Nickel	N/A

Handle - Whitmore® Ref. No. 1 & 2 <a href="#">page 97</a>			
<b>Note:</b> Handles are sold assembled with escutcheon plates.	Finish	Left Interior/ Right Exterior	Right Interior/ Left Exterior
	Antique Brass	N/A	2573226
	Bright Brass	2573227	N/A
	Oil Rubbed Bronze	N/A	N/A
	Satin Nickel	2573231	2573232

Thumb Latch / Latch Lever - Whitmore® / Interior Lock Ref. No. 4 <a href="#">page 97</a>		
<b>Note:</b> Ships with fasteners. See <a href="#">Latch Lever Replacement Video</a> .	Finish	Order No.
	Antique Brass	2573242
	Bright Brass	2573243
	Oil Rubbed Bronze	2573244
	Satin Nickel	2573245

Cover Plate with Screws - Whitmore® / 4 Panel Ref. No. 8 <a href="#">page 97</a>		
<b>Note:</b> Ships with fasteners. Use one cover plate on two-panel units; three cover plates on four-panel units.	Finish	Order No.
	Antique Brass	2573252
	Bright Brass	2573253
	Oil Rubbed Bronze	2573254
	Satin Nickel	2573255

## Hardware

### Screw Package - Trim Set / Whitmore®

**Note:**

Screw package is shown in the shared hardware section [page 110](#).

### Lock Assembly with Keys - Whitmore® / Exterior

**Note:**

Lock assemblies will have two (2) cut keys and two (2) 2 1/4" bolts [page 112](#).

Order keyed alike exterior locks in quantities needed.

See [Accessory Guide 0005196](#). See [Installation Video](#).

	Finish	Lock Assembly		Keyed Alike	
		Left	Right	Left	Right
	Antique Brass	2573272	2573093	9056164	9056168
	Bright Brass	2573273	2573094	9056165	9056169
	Oil Rubbed Bronze	2573274	2573095	9056166	9056170
Satin Nickel	2573275	2573096	9056167	9056171	

### Lock Assembly with Keys - Whitmore® / Exterior/ Keyed Alike Right-Hand and Left-Hand

**Note:**

Contains 1 right hand and 1 left hand assembly

Finish	Order No.
Antique Brass	9056212
Bright Brass	9056213
Oil Rubbed Bronze	9056214
Satin Nickel	9056215

# 400 Series Frenchwood® Gliding Doors (1987 to Present)

2-Panel, 4-Panel, and Stationary

## Hardware

### Key Cylinder - Whitmore®

**Note:**

Whitmore® lock assembly uses a 6 pin replacement cylinder are found on [page 112](#).

### Bolt Package - Whitmore® / Exterior Lock

**Note:**

Bolt package is included in the shared lock parts section [page 112](#).

### Lock Housing - Whitmore® / Exterior

**Note:**

Replace with complete exterior lock assembly.

Finish	Order No.
Antique Brass	N/A
Bright Brass	
Oil Rubbed Bronze	
Satin Nickel	

## Hardware

### Hardware - Encino®

**Note:** See [Accessory Guide 0005414](#). Trim set does not include [reachout lock/latch receiver](#). Consider ordering a new reachout lock/latch receiver kit when replacing your trim set.

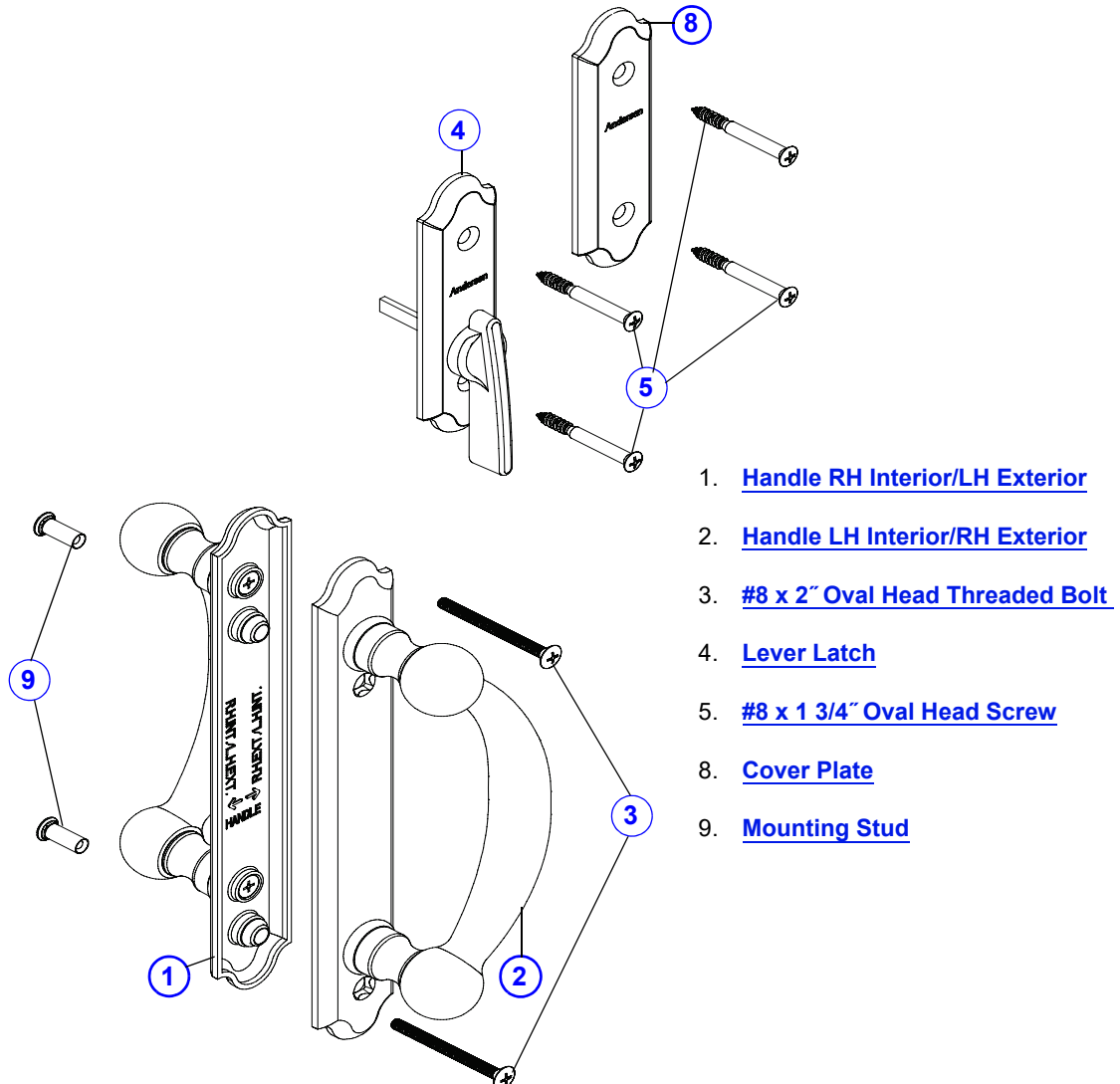

**Encino® Gliding Patio Door Hardware - 2-Panel Trim Set**

#### Trim Set Hardware - Encino® / Interior and Exterior / 2-Panel

Finish	Order No.
Distressed Bronze	2565553
Distressed Nickel	2565555

#### Trim Set Hardware - Encino® / Interior and Exterior / 4-Panel

Finish	Order No.
Distressed Bronze	2565554
Distressed Nickel	2565556

# 400 Series Frenchwood® Gliding Doors (1987 to Present)

2-Panel, 4-Panel, and Stationary

## Hardware

Trim Set Hardware - Encino® / Interior / 2-Panel		
	Finish	Order No.
	Distressed Bronze	2562113
	Distressed Nickel	2562117
Trim Set Hardware - Encino® / Interior / 4-Panel		
	Finish	Order No.
	Distressed Bronze	2562104
	Distressed Nickel	2562108
Trim Set Hardware - Encino® / Exterior / 2-Panel		
	Finish	Order No.
	Distressed Bronze	2562058
	Distressed Nickel	2562062
Trim Set Hardware - Encino® / Exterior / 4-Panel		
	Finish	Order No.
	Distressed Bronze	2562059
	Distressed Nickel	2562063

Handle - Encino® Ref. No. 1 & 2 <a href="#">page 101</a>			
Note: Handles are sold assembled with escutcheon plates	Finish	Left Interior/ Right Exterior	Right Interior/ Left Exterior
	Distressed Bronze	2573161	2573162
	Distressed Nickel	2573163	2573164

Cover Plate with Screws - Encino® / 4-Panel Ref. No. 8 <a href="#">page 101</a>		
Note: Ships with fasteners. Use one cover plate on two-panel units; three cover plates on four-panel units.	Finish	Order No.
	Distressed Bronze	2573175
	Distressed Nickel	2573176

Thumb Latch/Latch Lever - Encino® / Inside Lock Ref. No. 4 <a href="#">page 101</a>		
Note: Ships with fasteners. See <a href="#">Latch Lever Replacement Video</a> .	Finish	Order No.
	Distressed Bronze	2573169
	Distressed Nickel	2573170

Screw Package - Trim Set / Encino®
Note: Screw package is shown in the shared hardware section <a href="#">page 110</a> .

## Hardware

### Lock Assembly with Keys - Encino®

**Note:**

Lock assemblies will have two (2) cut keys and two (2) 2 1/4" bolts [page 112](#).

Order keyed alike exterior locks in quantities needed.

See [Accessory Guide 0005196](#). See [Installation Video](#).

	<b>Finish</b>	<b>Lock Assembly</b>		<b>Keyed Alike</b>		
		<b>Left</b>	<b>Right</b>	<b>Left</b>	<b>Right</b>	
		Distressed Bronze	2573189	2573086	9056182	9056184
		Distressed Nickel	2573190	2573087	9056183	9056185

### Lock Assembly with Keys - Encino® / Exterior / Keyed Alike Right Hand and Left Hand

**Note:**

Contains 1 right hand and 1 left hand assembly

<b>Finish</b>	<b>Order No.</b>
Distressed Bronze	9056216
Distressed Nickel	9056217

### Key Cylinder - Encino®

**Note:**

Encino® lock assembly uses a 6 pin replacement cylinder are found on [page 112](#).

### Bolt Package - Encino® / Exterior Lock

**Note:**

Bolt package is included in the shared lock parts section [page 112](#).

### Lock Housing - Encino® / Exterior

**Note:**

Replace with complete exterior lock assembly.

<b>Finish</b>	<b>Order No.</b>
Distressed Bronze	N/A
Distressed Nickel	

# 400 Series Frenchwood® Gliding Doors (1987 to Present)

2-Panel, 4-Panel, and Stationary

## Hardware

### Hardware - Yuma®

**Note:**

See [Accessory Guide 0005414](#). Trim set does **not** include [reachout lock/latch receiver](#). Consider ordering a new reachout lock/latch receiver kit when replacing your trim set.

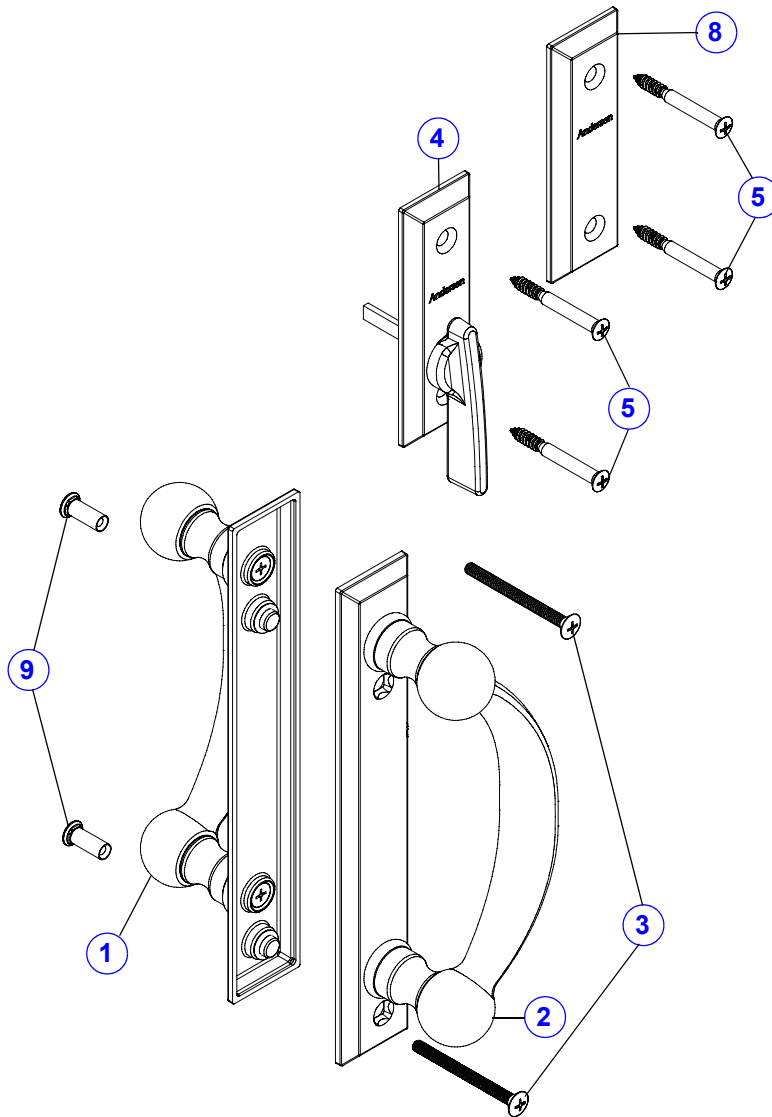

1. [HandleRH Interior/LH Exterior](#)
2. [Handle LH Interior/RH Exterior](#)
3. [#8 x 2" Oval Head Threaded Bolt](#)
4. [Latch Lever](#)
5. [#8 x1 3/4" Screw](#)
8. [Cover Plate](#)
9. [Mounting Stud](#)

Yuma® Gliding Patio Door Hardware - 2-Panel Trim Set

### Trim Set Hardware - Yuma® / Interior and Exterior

	Panels	Finish	Order No.
	2	Distressed Bronze	2565557
		Distressed Nickel	2565559
	4	Distressed Bronze	2565558
		Distressed Nickel	2565560

## Hardware

Trim Set Hardware - Yuma® / Interior			
	Panels	Finish	Order No.
	2	Distressed Bronze	2562115
		Distressed Nickel	2562119
	4	Distressed Bronze	2562106
		Distressed Nickel	2562110

Trim Set Hardware - Yuma® / Exterior			
	Panels	Finish	Order No.
	2	Distressed Bronze	2562060
		Distressed Nickel	2562064
	4	Distressed Bronze	2562061
		Distressed Nickel	2562065

Handle - Yuma® Ref. No. 1&2 <a href="#">page 104</a>			
Note: Handles are sold assembled with escutcheon plates.	Finish	Left Interior/ Right Exterior	Right Interior/ Left Exterior
	Distressed Bronze	2573165	2573166
	Distressed Nickel	2573167	2573168

Thumb Latch/Latch Lever - Yuma® / Inside Lock Ref. No. 4 <a href="#">page 104</a>		
Note: Ships with fasteners. See <a href="#">Latch Lever Replacement Video</a> .	Finish	Order No.
	Distressed Bronze	2573171
	Distressed Nickel	2573172

Cover Plate with Screws - Yuma® / 4-Panel Ref. No. 8 <a href="#">page 104</a>		
Note: Ships with fasteners. Use one cover plate on two-panel units; three cover plates on four-panel units.	Finish	Order No.
	Distressed Bronze	2573177
	Distressed Nickel	2573178

Screw Package - Trim Set / Yuma®
<b>Note:</b> Screw package is shown in the shared hardware section <a href="#">page 110</a> .



# 400 Series Frenchwood® Gliding Doors (1987 to Present)

2-Panel, 4-Panel, and Stationary

## Hardware

### Lock Assembly with Keys - Yuma®

**Note:**

Lock assemblies will have two (2) cut keys and two (2) 2 1/4" bolts [page 112](#).

Order keyed alike exterior locks in quantities needed.

See [Accessory Guide 0005196](#). See [Installation Video](#).

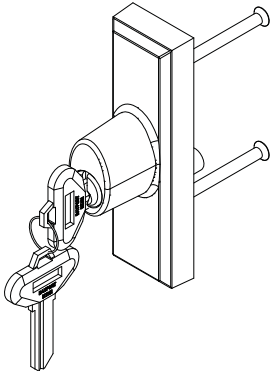
		Lock Assembly		Keyed Alike		
		Finish	Left	Right	Left	Right
		Distressed Bronze	2573193	2573088	9056188	9056186
		Distressed Nickel	2573194	2573089	9056189	9056187

### Lock Assembly with Keys - Yuma® / Exterior/ Keyed Alike Right-Hand and Left-Hand

**Note:**

Contains 1 right hand and 1 left hand assembly

Finish	Order No.
Distressed Bronze	9056218
Distressed Nickel	9056219

### Key Cylinder - Yuma®

**Note:**

Yuma® lock assembly uses a 6 pin replacement cylinder are found on [page 112](#).

### Bolt Package - Yuma® / Exterior Lock

**Note:**

Bolt package is included in the shared lock parts section [page 112](#).

### Lock Housing - Yuma® / Exterior

**Note:**

Replace with complete exterior lock assembly.

Finish	Order No.
Distressed Bronze	N/A
Distressed Nickel	

## Hardware

### Hardware - Albany

**Note:** See [Accessory Guide 0005414](#). Trim set does **not** include [reachout lock/latch receiver](#). Consider ordering a new reachout lock/latch receiver kit when replacing your trim set.

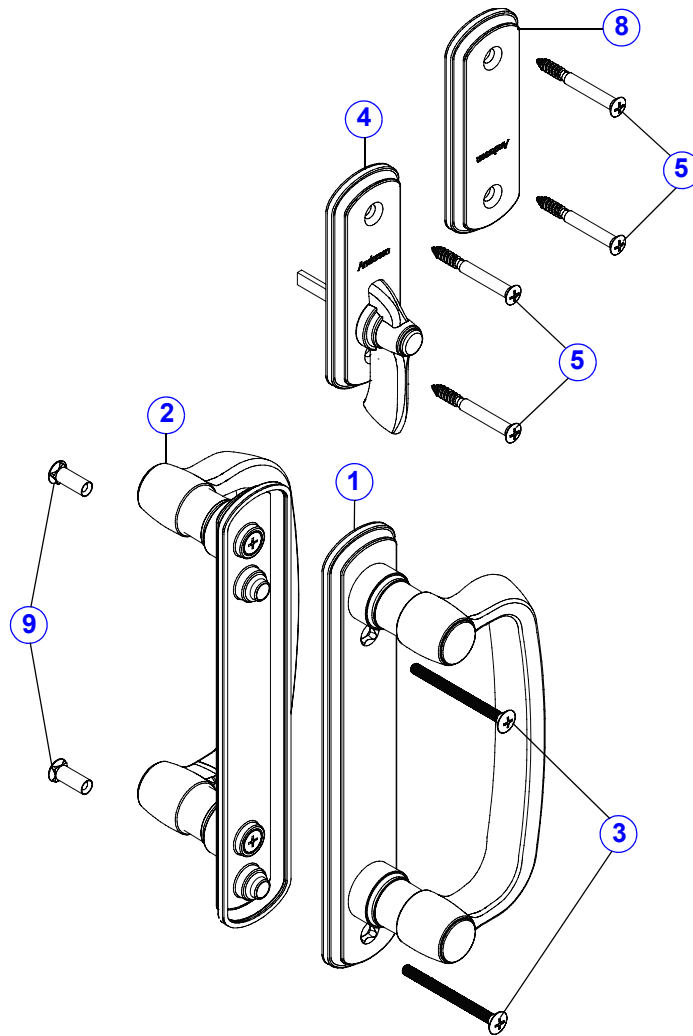

1. [Handle RH Interior/LH Exterior](#)
2. [Handle LH Interior/RH Exterior](#)
3. [#8 x 2" Oval Head Threaded Bolt](#)
4. [Latch Lever](#)
5. [#8 x 1 3/4" Screw](#)
8. [Cover Plate](#)
9. [Mounting Stud](#)

**Albany Gliding Patio Door Hardware - 2-Panel Trim Set**

## 400 Series Frenchwood® Gliding Doors (1987 to Present)

*2-Panel, 4-Panel, and Stationary*

### Hardware

Trim Set Hardware - Albany / Interior and Exterior			
	Panels	Finish	Order No.
	2	White	9007538
		Stone	9007539
		Gold Dust	N/A
		Black	9007541
	4	White	9007542
		Stone	9007543
		Gold Dust	N/A
		Black	9007545

Trim Set Hardware - Albany / Interior			
	Panels	Finish	Order No.
	2	White	9007554
		Stone	N/A
		Gold Dust	N/A
		Black	9007560
	4	White	9007555
		Stone	9007557
		Gold Dust	N/A
		Black	9007561

Trim Set Hardware - Albany / Exterior			
	Panels	Finish	Order No.
	2	White	9007562
		Stone	9007564
		Gold Dust	N/A
		Black	9007568
	4	White	9007563
		Stone	9007565
		Gold Dust	N/A
		Black	9007569

Handle - Albany Ref. No. 1 & 2 <a href="#">page 107</a>			
<b>Note:</b> Handles are sold assembled with escutcheon plates.	Finish	Left Interior/ Right Exterior	Right Interior/ Left Exterior
	White	9018914	9018915
	Stone	9018916	9018917
	Gold Dust	N/A	9018919
	Black	9018920	9018921

## Hardware

Thumb Latch/Latch Lever - Albany / Inside Lock Ref. No. 4 <a href="#">page 107</a>		
<b>Note:</b> Ships with fasteners. See <a href="#">Latch Lever Replacement Video</a> .	Finish	Order No.
	White	9018922
	Stone	9018923
	Gold Dust	N/A
	Black	9018925

Plate Cover - Albany Ref. No. 8 <a href="#">page 107</a>		
<b>Note:</b> Use one cover plate on two panel units; three cover plates on four panel units.s	Finish	Order No.
	White	9018926
	Stone	9018927
	Gold Dust	N/A
	Black	9018928

Screw Package - Trim Set / Albany		
<b>Note:</b> Screw package is shown in the shared hardware section <a href="#">page 110</a> .		

Lock Assembly with Keys - Albany/ Exterior					
<b>Note:</b> Lock assemblies will have two (2) cut keys and two (2) 2 1/4" bolts <a href="#">page 112</a> . Order keyed alike exterior locks in quantities needed. See <a href="#">Accessory Guide 0005196</a> . See <a href="#">Installation Video</a> .					
	Left	Right	Left	Right	
	White	9018898	9018902	9056190	9056194
	Stone	9018899	9018903	9056191	9056195
	Gold Dust	9018900	9018904	9056192	9056196
	Black	9018901	9018905	9056193	9056197

Lock Assembly with Keys - Albany / Exterior/ Keyed Alike Right-Hand and Left-Hand		
<b>Note:</b> Contains 1 right hand and 1 left hand assembly	Finish	Order No.
	White	9056220
	Stone	9056221
	Gold Dust	9056222
	Black	9056223

# 400 Series Frenchwood® Gliding Doors (1987 to Present)

2-Panel, 4-Panel, and Stationary

## Hardware

### Key Cylinder - Albany

**Note:**

Albany lock assembly uses a 6 pin replacement cylinder are found on [page 112](#).

### Bolt Package - Yuma® / Exterior Lock

**Note:**

Bolt package is included in the shared lock parts section [page 112](#).

### Lock Housing - Albany / Exterior

**Note:**

Replace with complete exterior lock assembly.

Finish	Order No.
White	N/A
Stone	
Gold Dust	
Black	

## Hardware

### Shared Trim Set Parts

**Screw Package - Trim Set / Trim Set / Newbury®, Anvers®, Covington™, Whitmore®, Yuma®, Encino®, Albany**

**Note:**

Newbury style shown. See unique [Tribeca trim set screw package](#). See [reachout lock replacement kit](#).

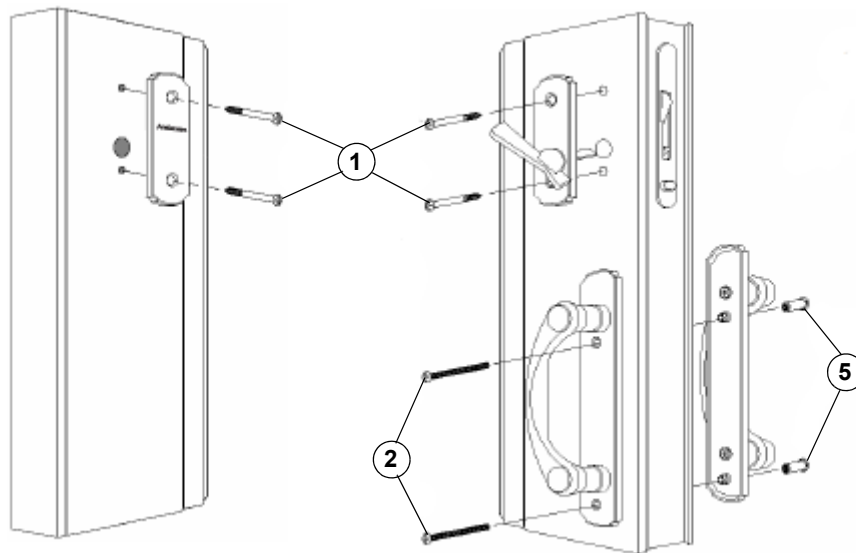

Ref. No.	Package Includes:	Finish	Order No.
<b>1</b>	(8) Screws, #10 -16 x 1 3/4" PH #8 oval head type AB	Stone (Albany)	9056232
<b>2</b>	(4) Screws, #8 - 32 UNC x 2 PH #10 oval head mach	White (Albany)	9056233
<b>5</b>	(4) Mounting studs	Antique Brass	2579762
	(1) Screw, 3" Security (not shown)	Bright Brass	2579761
	(2) Screws, Machine (not shown)	Polished Chrome	N/A
		Brushed Chrome	N/A
		Satin Nickel	2579391
		Distressed Nickel	2573180
		Oil Rubbed Bronze	2579765
		Distressed Bronze	2579765
		Gold Dust (Albany)	N/A
		Black (Albany)	9019314

# 400 Series Frenchwood® Gliding Doors (1987 to Present)

2-Panel, 4-Panel, and Stationary

## Hardware

### Screw Package - Trim Set / Tribeca® (2005 to Present) Ref. No.3,5 & 9 [page 84](#)

**Note:**

See [reachout lock replacement kit](#).

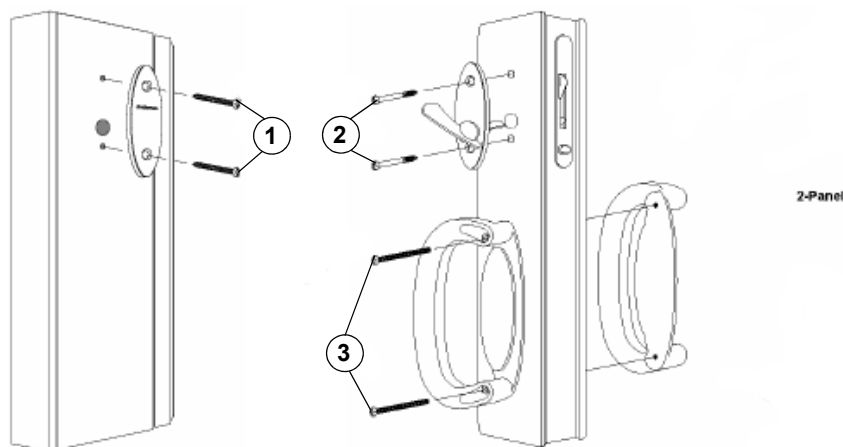

Ref. No.	Package Includes:	Finish	Order No.
1	(2) Screws, #10 x 1 3/4" oval head wood	Stone	2573468
2	(2) Screws, #10 -16 x 1 3/4" PH #8 oval head	White	2573467
3	(2) Screws, #8 - 32 UNC x 2 11/16" PH #10 oval HD mach (1) Screw, 3" Security (not shown) (2) Screws, Machine (not shown)	Black	9184676

### Screw Package - Trim Set / Metro /Tribeca® (1999 to 2005)

**Note:**

Used with Metro/Tribeca style hardware offered from 1999-2005.

**Package Includes:**

- (2) Screws, #10 x 1 3/4" Sheet metal
- (2) Screws, #8 x 2" Machine
- (2) Screws, #10 x 2 1/2" Machine
- (2) Screws, #8 x 13/16" Machine
- (1) Screw, #10 x 3" Flathead sheet metal

Finish	Order No.
Stone	2579769
White	2579768

### Trim Plate Assembly - 2 and 4 Panel



**Note:**

Distressed Bronze uses Oil Rubbed Bronze. Replace with 4 panel cover plate matching the hardware style of the trim set:

Finish	Order No.	Replacement
Polished Chrome	N/A	See Note
Antique Brass	N/A	See Note
Bright Brass	N/A	See Note
Oil Rubbed Bronze	N/A	See Note
Brushed Chrome	N/A	See Note
Satin Nickel	N/A	See Note
Distressed Bronze	N/A	See Note
Distressed Nickel	N/A	See Note



## Hardware

### Lock Parts

**Note:**

Current interior lock thumb latch is offered in twelve different finishes and eight different style types. See [trimset](#) sections.

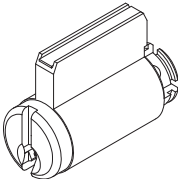
#### Lock Cylinder with Keys - 6-Pin (January 2004 to Present)

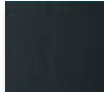
  <p>Bright Brass</p>  <p>Chrome</p>  <p>Oil Rubbed Bronze</p>	<p><b>Note:</b> Remove C ring and cylinder tab prior to installation. Newbury® lock assembly has used a 6 pin cylinder since January of 2004. Glass dates from panel do not always represent the vintage of the lock assembly or the replacement key cylinder needed. Finish on exterior facing surface may not match color of lock housing. Housing finish shown for identification purposes. The key used on a 6 pin cylinder will have 6 valleys/grooves.</p> <p>5 pin key cylinder 1994-2004 <a href="#">page 115</a></p> <p>See <a href="#">Service Guide 0005130</a>.</p>	<b>Housing Finish</b>	<b>Cylinder Finish</b>	<b>Order No.</b>
		White	Chrome	By description
		Stone	Chrome	By description
		Antique Brass	Bright Brass	By description
		Bright Brass	Bright Brass	By description
		Polished Chrome	Chrome	By description
		Brushed Chrome	Chrome	By description
		Satin Nickel	Chrome	By description
		Oil Rubbed Bronze	Oil Rubbed Bronze	By description
		Distressed Bronze	Oil Rubbed Bronze	By description
		Distressed Nickel	Chrome	By description
		Gold Dust	Chrome	By description
		Black	Oil Rubbed Bronze	By description

#### Blank Key - Reachout Lock

	<p><b>Note:</b> Six pin key blank</p>	<b>Order No.</b>
		2573561

#### Bolt for Exterior Lock Housing

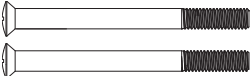
	<p><b>Note:</b> Distressed Bronze uses Oil Rubbed Bronze.</p> <p><b>Package Includes:</b> (2) Bolts, 2 1/4" x #10</p>	<b>Finish</b>	<b>Order No.</b>
		Polished Chrome	2573641
		Antique Brass	2573550
		Bright Brass	2573541
		Oil Rubbed Bronze	2579947
		Brushed Chrome	2579948
		Satin Nickel	2579423
		Distressed Bronze	2579947
		Distressed Nickel	2573158
		Gold Dust	9019315
		Black	9019316
		White	2573647
		Stone	2573648



# 400 Series Frenchwood® Gliding Doors (1987 to Present)

2-Panel, 4-Panel, and Stationary

## Hardware

Gear Kit - Keyed Lock / Exterior		Order No.
<p><b>Note:</b> Typically used on units manufactured after 1994. See <a href="#">Service Guide 0005386</a>. See <a href="#">Replacement Video</a>.</p>		
	<p><b>Kit Includes:</b></p> <ul style="list-style-type: none"> <li>1 (1) Tailpiece Receiver</li> <li>2 (3) Screws - #8-32UNC x 9/32, PH FL Undercut Mach</li> <li>3 (1) Small gear</li> <li>4 (1) LH Large gear (gold)</li> <li>5 (1) RH Large gear (sil.)</li> <li>(1) Flat washer (not shown)</li> </ul> <p><a href="#">Service Guide 0005386</a></p>	<p>2500707</p>
Lock and Receiver Kit - Reachout / 2-Panel (2006 to Present)		Order No.
	<p><b>Note:</b> Use this kit to replace previous vintage reachout locks (1994 to 2005). Refer to <a href="#">Accessory Guide 0005414</a> when using as trim set and hardware application and <a href="#">Service Guide 0000127</a> when using as reachout lock replacement. See <a href="#">Reachout Lock Replacement Video</a>.</p> <p><b>Kit Includes:</b></p> <ul style="list-style-type: none"> <li>(1) Reachout lock assembly</li> <li>(1) Two panel latch receiver</li> <li>(1) #10 x 3 flat head security screw</li> <li>(2) #8 x 7/8 machine screws</li> </ul>	<p>2562123</p>
Lock and Receiver Kit - Reachout / 4-Panel (2006 to Present)		Order No.
	<p><b>Note:</b> Use this kit to replace previous vintage reachout locks (1994 to 2005). Refer to <a href="#">Accessory Guide 0005414</a> when using as trim set and hardware application and <a href="#">Service Guide 0000127</a> when using as reachout lock replacement.</p> <p><b>Kit Includes:</b></p> <ul style="list-style-type: none"> <li>(1) Four panel receiver</li> <li>(1) Lock assembly, 9/64" allen wrench.</li> <li>(1) #10 x 3 flat head security screw</li> <li>(2) #8 x 7/8 machine screws</li> </ul>	<p>2562124</p>

## Hardware

Screw - Security / Reachout Strike / 2-Panel (1994 to Present)		
	Description	Order No.
	#10 x 3	2573574

### Auxiliary Security Lock with Screws

**Note:**  
See [Auxiliary Lock Installation Video](#). See individual [screws/fasteners](#).

 <p>parts.andersenwindows.com</p>		<b>Finish</b>	<b>Order No.</b>
		Stone	1997220
		White	1997301
		Polished Chrome	2565707
		Antique Brass	2565718
		Bright Brass	2565710
		Oil Rubbed Bronze	2579955
		Brushed Chrome	2579956
		Satin Nickel	2579426
		Distressed Bronze	2573187
		Distressed Nickel	2573188
		Black	9007625
	Gold Dust	9007624	

### Grommet - Auxiliary Security Lock

		<b>Order No.</b>
		9056272

# 400 Series Frenchwood® Gliding Doors (1987 to Present)

2-Panel, 4-Panel, and Stationary

## Hardware

### Vintage Lock Parts

#### Lock Cylinder with Keys - 5-Pin / Reachout Estate (1994 to January 2004)

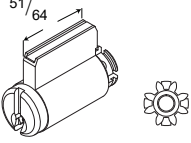
	<p><b>Note:</b> Includes gears and two keys, no tail. Remove C ring and cylinder tab prior to installation. Newbury® lock assembly has used a 6 pin cylinder since January of 2004. Glass dates from panel do not always represent the vintage of the lock assembly or the replacement key cylinder needed. The key used on a 5 pin cylinder will have 5 valleys/grooves.</p> <p>6 pin key cylinder 2004-Present <a href="#">page 112</a></p>	<b>Finish</b>	<b>Order No.</b>
		Silver Satin	2565715
		Bright Brass	2565717

#### Deadlock - Universal / Old Style / 2-Panel (1987 to 1993)

	<b>Order No.</b>
	1997156

#### Strike with Liner - Old Style (1987 to 1993)

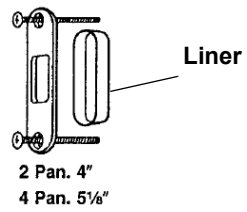
	<b>Type</b>	<b>Order No.</b>
	Strike with liner 2 panel	1997155
	Liner 4 panel	2565503

#### Screw - Reachout Receiver / Security / 2-Panel

<b>Description</b>	<b>Order No.</b>
3 x 10	2573574

#### Screw - Reachout Receiver / Machine / 2-Panel

<b>Description</b>	<b>Order No.</b>
#8-32	3620474

## Hardware

### Vintage Trim Set Parts

Handle - Inside / 2- and 3-Panel (1982)			
	<b>Note:</b> These can be used on 2-panel and 4-panel Frenchwood® Gliding units. Handle does not ship with <a href="#">bolt</a> .	Finish	Order No.
		Stone	1997201
		White	8292401

Handle - Outside / 2-Panel (1982)			
	<b>Note:</b> These can be used on 2-panel and 4-panel Frenchwood® Gliding units. Handle does not ship with <a href="#">bolt</a> .	Finish	Order No.
		Stone	1997202
		White	8292402

Handle - French Curve (1994 to 1999)				
	<b>Note:</b> French curve handles project over the glass.  Replace with current style handle(s) or trim set. Current Antique Brass finish may not match previous vintages of Antique Brass.	Finish	Left-Hand Interior/Right-Hand Exterior	Right-Hand Interior/Left-Hand Exterior
		Antique Brass	N/A	N/A
		HP Brass	N/A	N/A

Bolt - Handle Package			
	Description	Finish	Order No.
	2 <sup>3</sup> / <sub>32</sub> " x #10-32 O.H. steel	Stone	1275210
	<b>Note:</b> Order No. 1275210 replaces 2573646	White	1997295

Screw Package - Trim Set / Metro/Tribeca® (1999 to 2005)			
	<b>Note:</b> Used with Metro/Tribeca style hardware offered from 1999-2005.	Finish	Order No.
		Stone	2579769
		White	2579768

# 400 Series Frenchwood® Gliding Doors (1987 to Present)

2-Panel, 4-Panel, and Stationary

## Hardware

<b>Cover Plate - 4 Panel</b> (1987 to 1999)			
		<b>Finish</b>	<b>Order No.</b>
		Stone	2573508
		White	N/A

## Hardware

### Screw Packages / Knocked Down Frame

**Note:**

Select Forest Green and Dark Bronze screw packs use Terratone® screws.

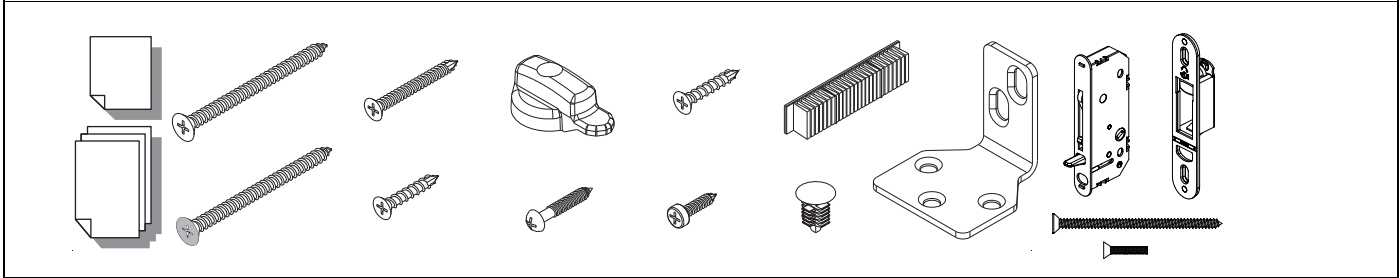

### Screw Package - Frame / FWG/NLGD 5068, 50611, 6068, 60611

Package Includes:		Where Used:	Color	Order No.
(2)	Panel handle hole plugs - gray	Operating panel side stile	White	2573654
(14)	2-1/2" x #10 (clear crm)	Frame, sill side jamb/head jamb	Terratone®	2653826
(9)	2-1/2" x #10	Frame to opening (color head)	Sandtone	0912804
(1)	Insect screen latch	Frame lock jamb	Forest Green	1260157
(1)	1" x #8 - colored	Screen latch	Canvas	9046450
(4)	1" x #8 - gray	Panel to sill filler flange	Dark Bronze	9071793
(5)	1" x #8 - colored	Head bracket screws (painted head)	Black	9129842
(7)	1-1/2" x #8 - brass	Head inside stop /sill support to wall	Prefinished White	2573671
(18)	5/8" x #7 - pan head	Interlock weatherstrip		
(1)	Stationary panel bracket	Head jamb and stationary panel		
(1)	Reachout Lock Assembly	Operating panel in lock route		
(1)	Two panel latch receiver	Frame receiver route in side jamb		
(1)	#10 x 3" FH Security Screw	Center hole in latch receiver		
(2)	#8 x 7/8" Machine Screws	Top and bottom slots in latch receiver		

### Screw Package - Frame / FWG/NLGD 8068, 80611

Package Includes:		Where Used:	Color	Order No.
(2)	Panel handle hole plugs - gray	Operating panel side stile	White	2573650
(14)	2-1/2" x #10 (clear crm)	Frame, sill side jamb/head jamb	Terratone®	2653835
(11)	2-1/2" x #10	Frame to opening (color head)	Sandtone	0912813
(5)	1" x #8 - colored	Head bracket screws (painted head)	Forest Green	1260158
(6)	1" x #8 - gray	Panel to sill filler flange	Canvas	9046456
(1)	1" x #8 - colored	Screen latch	Dark Bronze	9071795
(10)	1-1/2" x #8 - brass	Head inside stop /sill support to wall	Black	9129844
(18)	5/8" x #7 - pan head	Interlock weatherstrip	Prefinished White	2573673
(1)	Stationary panel bracket	Head jamb and stationary panel		
(1)	Insect screen latch	Frame lock jamb		
(1)	Reachout Lock Assembly	Operating panel in lock route		
(1)	Two panel latch receiver	Frame receiver route in side jamb		
(1)	#10 x 3" FH Security Screw	Center hole in latch receiver		
(2)	#8 x 7/8" Machine Screws	Top and bottom slots in latch receiver		

## 400 Series Frenchwood® Gliding Doors (1987 to Present)

*2-Panel, 4-Panel, and Stationary*

### Hardware

Screw Package - Frame / FWG/NLGD 5080, 6080, 8080				
	Package Includes:	Where Used:	Color	Order No.
	(2) Panel handle hole plugs - gray	Operating panel side stile	<b>White</b>	2573655
	(14) 2-1/2" x #10 (clear crm)	Frame, sill side jamb/head jamb	<b>Terratone®</b>	2653827
	(13) 2-1/2" x #10	Frame to opening (color head)	<b>Sandtone</b>	0912805
	(5) 1" x #8 - colored	Head bracket screws (painted head)	<b>Forest Green</b>	1260159
	(6) 1" x #8 - gray	Panel to sill filler flange	<b>Canvas</b>	9046451
	(1) 1" x #8 - colored	Screen latch	<b>Dark Bronze</b>	9071794
	(10) 1-1/2" x #8 - brass	Head inside stop /sill support to wall	<b>Black</b>	9129843
	(22) 5/8" x #7 - pan head	Interlock weatherstrip	<b>Prefinished White</b>	2573672
	(1) Stationary panel bracket	Head jamb and stationary panel		
	(1) Insect screen latch	Frame lock jamb		
	(1) Reachout lock assembly	Operating panel in lock route		
	(1) Two panel latch receiver	Frame receiver route in side jamb		
	(1) #10 x 3" FH Security Screw	Center hole in latch receiver		
	(2) #8 x 7/8" Machine Screws	Top and bottom slots in latch receiver		

Screw Package - Frame / FWG/NLGD 10068, 12068, 100611, 120611				
	Package Includes:	Where Used:	Color	Order No.
	(4) Panel handle hole plugs - gray	Operating panel side stile	<b>White</b>	2573656
	(14) 2-1/2" x #10 (clear crm)	Frame, sill side jamb/head jamb	<b>Terratone®</b>	2653828
	(13) 2-1/2" x #10	Frame to opening (color head)	<b>Sandtone</b>	0912806
	(1) 5/8" x #7 filister head	4-panel screw lock stopper screw	<b>Forest Green</b>	2653828
	(8) 1" x #8 - gray	Panel to sill filler flange	<b>Canvas</b>	0912806
	(10) 1" x #8 - colored	Head bracket screws (painted head)	<b>Dark Bronze</b>	2653828
	(20) 1-1/2" x #8 - brass	Head inside stop /sill support to wall	<b>Black</b>	0912806
	(36) 5/8" x #7 - pan head	Interlock weatherstrip	<b>Prefinished White</b>	2573674
	(2) Stationary panel bracket	Head jamb and stationary panel		
	(1) Reachout lock assembly	Operating panel in lock route		
	(1) Four panel latch receiver	Astragal lock route		

Screw Package - Frame / FWG/NLGD 16068, 160611				
	Package Includes:	Where Used:	Color	Order No.
	(4) Panel handle hole plugs - gray	Operating panel side stile	<b>White</b>	2573657
	(14) 2-1/2" x #10 (clear crm)	Frame, sill side jamb/head jamb	<b>Terratone®</b>	2653829
	(17) 2-1/2" x #10	Frame to opening (color head)	<b>Sandtone</b>	0912807
	(1) 5/8" x #7 filister head	4-panel screw lock stopper screw	<b>Forest Green</b>	2653829
	(8) 1" x #8 - gray	Panel to sill filler flange	<b>Canvas</b>	0912807
	(10) 1" x #8 - colored	Head bracket screws (painted head)	<b>Dark Bronze</b>	2653829
	(20) 1-1/2" x #8 - brass	Head inside stop /sill support to wall	<b>Black</b>	0912807
	(36) 5/8" x #7 - pan head	Interlock weatherstrip	<b>Prefinished White</b>	2573676
	(2) Stationary panel bracket	Head jamb and stationary panel		
	(1) Reachout lock assembly	Operating panel in lock route		
	(1) Four panel latch receiver	Astragal lock route		

## Hardware

Screw Package - Frame / FWG/NLGD 10080, 12080				
	Package Includes:	Where Used:	Color	Order No.
			(4) Panel handle hole plugs - gray	Operating panel side stile
(14) 2-1/2" x #10 (clear crm)	Frame, sill side jamb/head jamb	Terratone®	2653831	
(15) 2-1/2" x #10	Frame to opening (color head)	Sandtone	0912801	
(1) 5/8" x #7 filister head	4-panel screw lock stopper screw	Forest Green	2653831	
(8) 1" x #8 - gray	Panel to sill filler flange	Canvas	0912801	
(10) 1" x #8 - colored	Head bracket screws (painted head)	Dark Bronze	2653831	
(20) 1-1/2" x #8 - brass	Head inside stop /sill support to wall	Black	0912801	
(36) 5/8" x #7 - pan head	Interlock weatherstrip	Prefinished White	2573675	
(2) Stationary panel bracket	Head jamb and stationary panel			
(1) Reachout lock assembly	Operating panel in lock route			
(1) Four panel latch receiver	Astragal lock route			

Screw Package - Frame / FWG/NLGD 16080				
	Package Includes:	Where Used:	Color	Order No.
			(4) Panel handle hole plugs - gray	Operating panel side stile
(14) 2-1/2" x #10 (clear crm)	Frame, sill side jamb/head jamb	Terratone®	2653832	
(19) 2-1/2" x #10	Frame to opening (color head)	Sandtone	0912803	
(1) 5/8" x #7 filister head	4-panel screw lock stopper screw	Forest Green	2653832	
(8) 1" x #8 - gray	Panel to sill filler flange	Canvas	0912803	
(10) 1" x #8 - colored	Head bracket screws (painted head)	Dark Bronze	2653832	
(20) 1-1/2" x #8 - brass	Head inside stop /sill support to wall	Black	0912803	
(36) 5/8" x #7 - pan head	Interlock weatherstrip	Prefinished White	2573677	
(2) Stationary panel bracket	Head jamb and stationary panel			
(1) Reachout lock assembly	Operating panel in lock route			
(1) Four panel latch receiver	Astragal lock route			

Screw Package - Sidelight / Frame / FWG/NLGD 29, 33, 43				
	Package Includes:	Where Used:	Color	Order No.
			(14) 2-1/2" x #10 (clear crm)	Frame, sill side jamb/head jamb
(10) 2-1/2" x #10 (colored heads)	Frame to opening (color head)	Terratone®	2653825	
(4) 1" x #8 gray	Panel to sill filler flange	Sandtone	0912802	
(12) 3/4" x #8	Exterior side stops	Forest Green	1262831	
		Canvas	9046449	
		Dark Bronze	9071816	
		Black	9129845	
		Prefinished White	2573653	



# 400 Series Frenchwood® Gliding Doors (1987 to Present)

2-Panel, 4-Panel, and Stationary

## Hardware

### Screw Packages / Factory Assembled

**Note:**

See color detail for 2 1/2" x #10 screws. Terratone, Forest Green and Dark Bronze screw packs contain Terratone® screws. Sandtone, Canvas and Black screw packs contain Sandtone screws.

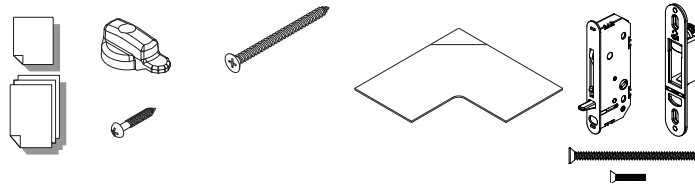

#### Installation Screw Package - 5068, 50611, 6068, 60611 Factory Assembled Units

<p><b>Package Includes:</b>                  (9) 2 1/2" x #10 screws                  (2) Flange corner gaskets                  (1) Insect screen latch                  (1) 1" x #8 screw (Screen Latch)  <a href="#">Installation Guide 0005482</a></p>	<b>Color</b>	<b>Order No.</b>
	White	2573489
	Terratone®	2653870
	Sandtone	0912819
	Forest Green	1260160
	Canvas	9046440
	Dark Bronze	9071798
	Black	9129929

#### Installation Screw Package - 8068, 80611 Factory Assembled Units

<p><b>Package Includes:</b>                  (11) 2 1/2" x #10 screws                  (2) Flange corner gaskets                  (1) Insect screen latch                  (1) 1" x #8 screw (Screen Latch)  <a href="#">Installation Guide 0005482</a></p>	<b>Color</b>	<b>Order No.</b>
	White	2573490
	Terratone®	2653871
	Sandtone	0912820
	Forest Green	1260161
	Canvas	9046441
	Dark Bronze	9071802
	Black	9129931

#### Installation Screw Package - 5080, 6080, 8080 Factory Assembled Units

<p><b>Package Includes:</b>                  (13) 2 1/2" x #10 screws                  (2) Flange corner gaskets                  (1) Insect screen latch                  (1) 1" x #8 screw (Screen Latch)  <a href="#">Installation Guide 0005482</a></p>	<b>Color</b>	<b>Order No.</b>
	White	2573491
	Terratone®	2653872
	Sandtone	0912821
	Forest Green	1260162
	Canvas	9046442
	Dark Bronze	9071799
	Black	9129930

#### Installation Screw Package - 29, 33, 43 Sidelight Factory Assembled Units

<p><b>Package Includes:</b>                  (11) 2 1/2" x #10 screws                  (2) Flange corner gaskets  <a href="#">Installation Guide 0005482</a></p>	<b>Color</b>	<b>Order No.</b>
	White	9014550
	Terratone®	9014552
	Sandtone	9014549
	Canvas	9014549
	Dark Bronze	9014552
	Black	9014549

## Hardware

<b>Screw Package / Frame (Impact Resistant) / Stormwatch®</b>		
<b>Screw Package - Panel / 2-Panel (Impact Resistant)</b>		
	<b>Color</b>	<b>Order No.</b>
	White	2573698
	Terratone®	2653866
	Sandtone	
	Prefinished Interior White	2573702







<b>Screw Package - Frame / 2-Panel (Impact Resistant)</b>		
	<b>Color</b>	<b>Order No.</b>
	White	2573696
	Terratone®	2653865
	Sandtone	0912816
	Forest Green	1262192
	Prefinished Interior White	2573697

<b>Screw Package - Frame / Sidelight (Impact Resistant)</b>		
	<b>Color</b>	<b>Order No.</b>
	White	2573701
	Terratone®	2653868
	Sandtone	0912818
	Forest Green	1262194

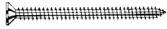
# 400 Series Frenchwood® Gliding Doors (1987 to Present)

2-Panel, 4-Panel, and Stationary

## Hardware

<b>Fasteners</b>				
<b>Screw - Frame</b>				
	Description		Steel	
	2 1/2" x #10 F.H. steel		1973113	
<b>Screw - Security Lock</b>				
	Description		Finish	Order No.
	2" x #8 Dome head		White	1997299
			Stone	By description
			Brass	2573644
			Antique Brass	2573552
			Chrome	2573643
			Oil Rubbed Bronze	By description
			Gold Dust	By description
Black			By description	
<b>Screw - Sill Support</b>				
	Description		Order No.	
	1 1/2" x #8 F.H. steel		3622195	
<b>Screw - Inside Head Stop</b>				
	Description		Order No.	
	1 1/2" x #8 F.H. steel		3629055	
<b>Screw - Sill Filler</b>				
	Description		Finish	Order No.
	8-15 x 7/8"		Gray	3629102
<b>Screw - Head Bracket / Stationary Panel</b>				
	Description		Finish	Order No.
	8-18 x 1" TYP AB		Gray	1973112
			White	2500702
			Stone	2653862
<b>Screw - Interlock Weatherstrip</b>				
	Description		Color	Order No.
	5/8" x 7-19 PH Flat Pan HD, Type 17		White	1973109
			Gray	2641210
<b>Screw - Insect Screen Stop / 4-Panel</b>				
	Description		Order No.	
	5/8" x #7 F.H. steel		1973107	

## Hardware

Screw - I.D. Plate			
	Description	Finish	Order No.
	5/8" x #6 F.H. steel	Stone	9056235
		White	9056234

Screw - Insect Screen Pull / 2-Panel		
	Description	Stone
	1" x #6 F.H. steel	By description

Screw - Insect Screen Stopper / 4-Panel			
	Description	Finish	Order No.
	5/8" x #8 Fillister stainless steel	Stone	8292922
		White	8292923

Screw - Lock Strike		
	Description	Silver
	1 3/16" x #8-32 Mach F.H. steel	8323406

Screw		
	Description	Order No.
	10-12 x 1 PH PAN HD TA 18-8 SST	2579405

Screw			
	Description	Color	Order No.
	10-12 x 2 PH OVAL TA 18-8	White	2579403
		Beige	2579404
		Terratone®	2653869
		Sandtone	0912719
		Forest Green	1269111

Screw			
	Description	Color	Order No.
	8-15 x 1 TYP 17PH FH HEAD T/C Z-Y	White	2500702
		Terratone®	2653862
		Gray	2500704

Screw			
	Description	Color	Order No.
	8-18 x 3/4 TYP 17 PH FH HEAD T/C	White	2500706
		Terratone®	2653864
		Sandtone	0904112
		Forest Green	1269110

# 400 Series Frenchwood® Gliding Doors (1987 to Present)

2-Panel, 4-Panel, and Stationary

## Hardware

Screw - Reachout Strike Conversion		
	Description	Order No.
	5/8 x 8 FH	2573575
Screw		
	Description	Forest Green
	10-12 x 1 1/2 TYP 17 PH FH STL Z-Y	1269109
Screw		
	Description	Order No.
	8-15 x 1 1/2 TYP 17 PH FH Z-Y	2500701
Screw		
	Description	Gray
	10 x 2-1/2 TYP AB PH PAN 410SS	0912718

# Frames

## Frame Assembly

**Note:**

See latest [Product Details](#).

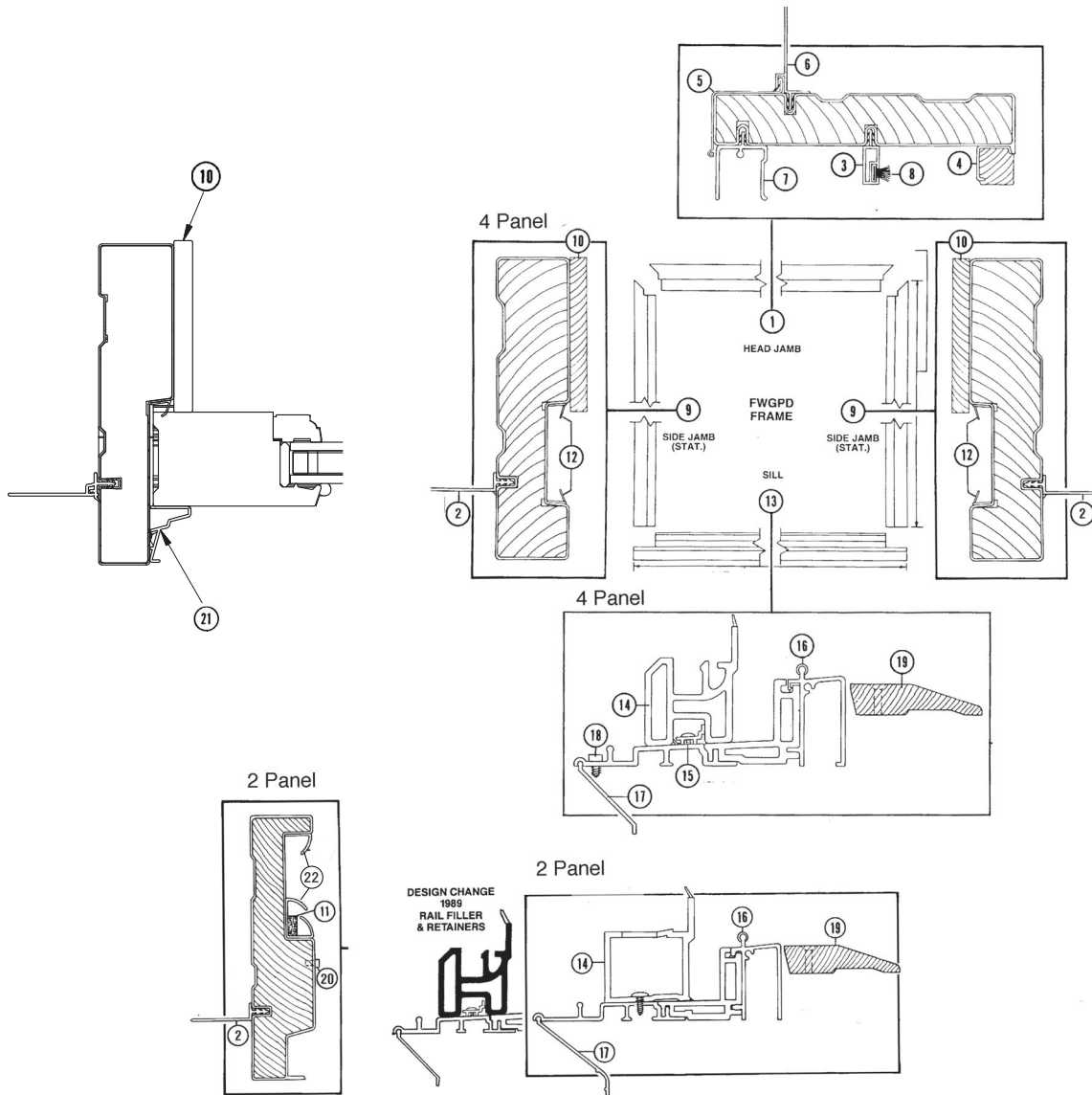

- |  |   |  |
|--|---|--|
| 1. <a href="#">Head Jamb Complete</a>          | 8. Head Parting Stop Pile W/S                     | 15. <a href="#">Center and End Rail Filler Retainers</a> |
| 2. <a href="#">Side Windbreak Flange (Pr.)</a> | 9. <a href="#">Stationary Side Jamb</a>           | 16. <a href="#">Sill Track Cap</a>                       |
| 3. <a href="#">Head Parting Stop</a>           | 10. <a href="#">Stationary Jamb Trim Piece</a>    | 17. <a href="#">Sill Support</a>                         |
| 4. <a href="#">I.S. Head Stop</a>              | 11. <a href="#">Operator Side Jamb Plug</a>       | 18. Insect Screen Stopper Screw                          |
| 5. <a href="#">Head Flashing</a>               | 12. <a href="#">Stationary Jamb Weatherstrip</a>  | 19. <a href="#">Oak Threshold (Optional)</a>             |
| 6. <a href="#">Head Installation Flange</a>    | 13. <a href="#">Sill</a>                          | 20. Insect Screen Lock Hole Plug - Fillister Head Screw  |
| 7. <a href="#">Insect Screen Guide</a>         | 14. <a href="#">Stationary Bottom Rail Filler</a> | 21. <a href="#">Outside Sidelight Stop</a>               |
|  |   | 22. <a href="#">Operating Side Jamb Weatherstrip</a>     |



### Frenchwood® Gliding Frame Assembly - 2 and 4-Panel



# 400 Series Frenchwood® Gliding Doors (1987 to Present)

2-Panel, 4-Panel, and Stationary

## Frames

### Frame Only

Frame / Sidelight / Pine Interior					
	Exterior				
	White	Terratone®	Sandtone	Forest Green	
	Interior				
					
Unit No					
<b>29</b>	FWG2968	2565022	2650013	0910020	1262001
	FWG29611	2565050	2650056	0910056	By description
	FWG2980	2565042	2650042	0910042	By description
<b>33</b>	FWG3368	2565018	2650014	0910022	1262004
	FWG33611	2565051	2650057	0910057	1262005
	FWG3380	2565044	2650044	0910044	1262006
<b>43</b>	FWG4368	2565020	2650016	0910024	By description
	FWG43611	2565052	2650058	0910058	By description
	FWG4380	2565046	2650046	0910046	By description

Frame / Sidelight / Oak Interior					
	Exterior				
	White	Terratone®	Sandtone	Forest Green	
	Interior				
					
Unit No					
<b>29</b>	FWG2968	2565079	By description	By description	By description
	FWG29611	By description	By description	By description	By description
	FWG2980	By description	By description	By description	By description
<b>33</b>	FWG3368	2565071	2650017	0910023	By description
	FWG33611	2565077	By description	By description	By description
	FWG3380	By description	By description	By description	By description
<b>43</b>	FWG4368	By description	By description	By description	By description
	FWG43611	By description	By description	By description	By description
	FWG4380	By description	By description	By description	By description

### Frames

Frame / Sidelight / Maple Interior					
	<b>Exterior</b> White    Terratone®    Sandtone    Forest Green				
	<b>Interior</b> MAPLE				
	<b>Unit No</b>				
<b>29</b>	<b>FWG2968</b>	By description	By description	By description	By description
	<b>FWG29611</b>	By description	By description	By description	By description
	<b>FWG2980</b>	By description	By description	By description	By description
<b>33</b>	<b>FWG3368</b>	By description	By description	By description	By description
	<b>FWG33611</b>	By description	By description	By description	By description
	<b>FWG3380</b>	By description	By description	By description	By description
<b>43</b>	<b>FWG4368</b>	By description	By description	By description	By description
	<b>FWG43611</b>	By description	By description	By description	By description
	<b>FWG4380</b>	By description	By description	By description	By description

Frame / Sidelight / White Interior		
	<b>Exterior</b>	
	White	
	<b>Interior</b>	
	White	
<b>Unit No</b>		<b>Order No.</b>
<b>29</b>	<b>FWG2968</b>	2565155
	<b>FWG29611</b>	2565158
	<b>FWG2980</b>	2565161
<b>33</b>	<b>FWG3368</b>	2565156
	<b>FWG33611</b>	2565159
	<b>FWG3380</b>	2565162
<b>43</b>	<b>FWG4368</b>	2565157
	<b>FWG43611</b>	By description
	<b>FWG4380</b>	2565163



# 400 Series Frenchwood® Gliding Doors (1987 to Present)



*2-Panel, 4-Panel, and Stationary*

## Frames

Frame with Interlock Weatherstrip & Screws / 2 - Panel / Pine Interior										
	Exterior									
	White			Terratone®			Sandtone		Forest Green	
	Interior									
<div style="background-color: #d2b48c; padding: 10px; display: inline-block; border: 1px solid #ccc;"> <span style="font-size: 2em; font-weight: bold; color: white;">PINE</span> </div>										
Unit No	Left	Right	Left	Right	Left	Right	Left	Right		
<b>50</b>	<b>FWG5068</b>	2565006	2565008	2650002	2650004	0910002	0910004	1262028	1262029	
	<b>FWG50611</b>	2565023	2565024	2650047	2650048	0910047	0910048	1262030	1262031	
	<b>FWG5080</b>	2565030	2565032	2650030	2650032	0910030	0910032	1262032	1262033	
<b>60</b>	<b>FWG6068</b>	2565010	2565012	2650006	2650008	0910006	0910008	1262034	1262035	
	<b>FWG6068 (RC)</b>	See iQ+ or original Order Source	See iQ+ or original Order Source							
	<b>FWG60611</b>	2565025	2565026	2650049	2650050	0910049	0910050	1262036	1262037	
	<b>FWG6080</b>	2565034	2565036	2650034	2650036	0910034	0910036	1262038	1262039	
<b>80</b>	<b>FWG8068</b>	2565014	2565016	2650010	2650012	0910010	0910012	1262040	1262041	
	<b>FWG80611</b>	2565027	2565028	2650051	2650052	0910051	0910052	1262042	1262043	
	<b>FWG8080</b>	2565038	2565040	2650038	2650040	0910038	0910040	1262044	1262045	

Frame with Interlock Weatherstrip & Screws / 2 - Panel / Oak Interior										
	Exterior									
	White			Terratone®			Sandtone		Forest Green	
	Interior									
<div style="background-color: #d2b48c; padding: 10px; display: inline-block; border: 1px solid #ccc;"> <span style="font-size: 2em; font-weight: bold; color: white;">OAK</span> </div>										
Unit No	Left	Right	Left	Right	Left	Right	Left	Right		
<b>50</b>	<b>FWG5068</b>	2565114	2565115	2650077	2650078	0910077	0910078	1262082	By description	
	<b>FWG50611</b>	2565116	By description	By description	By description	By description	By description	By description	By description	
	<b>FWG5080</b>	By description	By description	By description	By description	By description	By description	By description	By description	
<b>60</b>	<b>FWG6068</b>	2565120	2565122	2650083	2650084	0910083	0910084	1262088	1262089	
	<b>FWG60611</b>	2565123	2565124	2650085	2650086	0910085	0910086	By description	By description	
	<b>FWG6080</b>	2565125	2565126	By description	By description	0910087	By description	By description	By description	
<b>80</b>	<b>FWG8068</b>	2565127	2565128	2650089	2650090	0910089	0910090	1262094	1262095	
	<b>FWG80611</b>	2565129	2565130	2650091	2650092	0910091	0910092	By description	By description	
	<b>FWG8080</b>	By description	2565132	By description	By description	By description	By description	By description	By description	

### Frames



Frame with Interlock Weatherstrip & Screws / 2 - Panel / Maple Interior									
	<b>Exterior</b>								
	White			Terratone®		Sandtone		Forest Green	
	<b>Interior</b>								
									
Unit No	Left	Right	Left	Right	Left	Right	Left	Right	
<b>50</b>	<b>FWG5068</b>	2565133	2565134	By description	By description	By description	By description	By description	By description
	<b>FWG50611</b>	By description	By description	By description	By description	By description	By description	By description	By description
	<b>FWG5080</b>	By description	By description	By description	By description	By description	By description	By description	By description
<b>60</b>	<b>FWG6068</b>	2565139	2565140	2650117	2650118	0910279	0910280	1262061	By description
	<b>FWG60611</b>	2565141	2565142	2650119	2650120	0910281	0910282	By description	By description
	<b>FWG6080</b>	By description	2565144	By description	By description	By description	By description	By description	By description
<b>80</b>	<b>FWG8068</b>	2565145	2565146	2650123	2650124	0910285	0910286	By description	By description
	<b>FWG80611</b>	2565147	2565148	By description	By description	By description	By description	By description	By description
	<b>FWG8080</b>	By description	By description	By description	By description	By description	By description	By description	By description



Frame with Interlock Weatherstrip & Screws / 2 - Panel / White Interior			
	<b>Exterior</b>		
	White		
	<b>Interior</b>		
	White		
Unit No	Left	Right	
<b>50</b>	<b>FWG5068</b>	2565164	2565165
	<b>FWG50611</b>	2565173	2565174
	<b>FWG5080</b>	2565182	2565183
<b>60</b>	<b>FWG6068</b>	2565166	2565167
	<b>FWG60611</b>	2565175	2565176
	<b>FWG6080</b>	2565184	2565185
<b>80</b>	<b>FWG8068</b>	2565168	2565169
	<b>FWG80611</b>	2565177	2565178
	<b>FWG8080</b>	2565186	2565187

## 400 Series Frenchwood® Gliding Doors (1987 to Present)

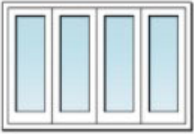

*2-Panel, 4-Panel, and Stationary*

### Frames

Frame with Interlock Weatherstrip & Screws / 4 - Panel / Pine Interior					
		Exterior			
		White	Terratone®	Sandtone	Forest Green
		Interior			
Unit No					
<b>100</b>	FWG10068	2565106	2650104	0910014	1262046
	FWG100611	2565047	2650053	0910053	1262047
	FWG10080	2565107	2650105	0910015	1262048
<b>120</b>	FWG12068	2565108	2650106	0910016	1262049
	FWG120611	2565048	2650054	0910054	1262050
	FWG12080	2565109	2650107	0910017	1262051
<b>160</b>	FWG16068	2565110	2650108	0910018	1262052
	FWG160611	2565049	2650055	0910055	1262053
	FWG16080	2565111	2650109	0910019	1262054

Frame with Interlock Weatherstrip & Screws / 4 - Panel / Oak Interior					
		Exterior			
		White	Terratone®	Sandtone	Forest Green
		Interior			
Unit No					
<b>100</b>	FWG10068	2565089	2650095	0910095	By description
	FWG100611	2565090	By description	By description	By description
	FWG10080	By description	By description	By description	By description
<b>120</b>	FWG12068	2565092	2650098	0910098	By description
	FWG120611	2565093	2650099	By description	By description
	FWG12080	2565094	By description	0910101	By description
<b>160</b>	FWG16068	2565095	By description	By description	By description
	FWG160611	By description	By description	By description	By description
	FWG16080	By description	By description	By description	By description

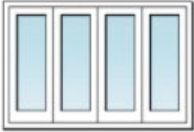
### Frames

Frame with Interlock Weatherstrip & Screws / 4 - Panel / Maple Interior					
	<b>Exterior</b>				
	White	Terratone®	Sandtone	Forest Green	
	<b>Interior</b>				
					
<b>Unit No</b>					
<b>100</b>	<b>FWG10068</b>	2565098	By description	By description	By description
	<b>FWG100611</b>	By description	By description	By description	By description
	<b>FWG10080</b>	By description	By description	By description	By description
<b>120</b>	<b>FWG12068</b>	2565102	2650132	0910294	By description
	<b>FWG120611</b>	2565103	By description	By description	By description
	<b>FWG12080</b>	By description	By description	By description	By description
<b>160</b>	<b>FWG16068</b>	By description	By description	By description	By description
	<b>FWG160611</b>	By description	By description	By description	By description
	<b>FWG16080</b>	By description	By description	By description	By description

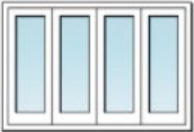
Frame with Interlock Weatherstrip & Screws / 4 - Panel / White Interior		
	<b>Exterior</b>	
	White	
	<b>Interior</b>	
	White	
<b>Unit No</b>		<b>Order No.</b>
<b>100</b>	<b>FWG10068</b>	2565170
	<b>FWG100611</b>	2565179
	<b>FWG10080</b>	2565188
<b>120</b>	<b>FWG12068</b>	2565171
	<b>FWG120611</b>	2565180
	<b>FWG12080</b>	2565189
<b>160</b>	<b>FWG16068</b>	2565172
	<b>FWG160611</b>	2565181
	<b>FWG16080</b>	2565190

# 400 Series Frenchwood® Gliding Doors (1987 to Present)

2-Panel, 4-Panel, and Stationary

## Frames

### Jamb

**Note:**

Side jambs are handed as unit is handed. As an example, a right-handed unit uses a right-handed operating side jamb and a right-handed stationary side jamb. Replacement side jambs are **not** available for units made prior to May 1, 2015. Full frame assembly must be replaced. Frame parts (head jambs, side jambs) for custom sized doors are made to order. Product ID label is located on top edge of operating panel. Maple and Oak finishes introduced in 2000.

To order, state:

1. Description of part (Head Jamb, Side Jamb)
2. Handing (RH or LH)
3. Quantity
4. Product ID (from product label, see [Service Guide 9051877](#))

#### Jamb - Head / Sidelight / Pine Interior

Unit No.	Length	Exterior			
		White	Terratone®	Sandtone	Forest Green
		Interior			
					
FWG29	32	By description	By description	By description	By description
FWG33	38	By description	By description	By description	By description
FWG43	50	By description	By description	By description	By description

#### Jamb - Head / Sidelight / Maple Interior

Unit No.	Length	Exterior			
		White	Terratone®	Sandtone	Forest Green
		Interior			
					
FWG29	32	By description	By description	By description	By description
FWG33	38	By description	By description	By description	By description
FWG43	50	By description	By description	By description	By description

#### Jamb - Head / Sidelight / Oak Interior

Unit No.	Length	Exterior			
		White	Terratone®	Sandtone	Forest Green
		Interior			
					
FWG29	32	By description	By description	By description	By description
FWG33	38	By description	By description	By description	By description
FWG43	50	By description	By description	By description	By description

#### Jamb - Head / Sidelight / Prefinished Interior White

	Unit No.	Length	Exterior/Interior
			White
	FWG29	32	By description
	FWG33	38	By description
	FWG43	50	By description

## Frames

Jamb - Head / 2-Panel / Pine Interior Ref. No. 1 <a href="#">page 127</a>									
Unit No.	Length	Exterior							
		White		Terratone®		Sandtone		Forest Green	
		Interior							
PINE								Left	Right
Left	Right	Left	Right	Left	Right	Left	Right	Left	Right
FWG50	59 1/4	By description		By description		By description		By description	
FWG60	71 1/4	By description		By description		By description		By description	
FWG80	95 1/4	By description		By description		By description		By description	
Jamb - Head / 2-Panel / Maple Interior Ref. No. 1 <a href="#">page 127</a>									
Unit No.	Length	Exterior							
		White		Terratone®		Sandtone		Forest Green	
		Interior							
MAPLE								Left	Right
Left	Right	Left	Right	Left	Right	Left	Right	Left	Right
FWG50	59 1/4	By description		By description		By description		By description	
FWG60	71 1/4	By description		By description		By description		By description	
FWG80	95 1/4	By description		By description		By description		By description	
Jamb - Head / 2-Panel / Oak Interior Ref. No. 1 <a href="#">page 127</a>									
Unit No.	Length	Exterior							
		White		Terratone®		Sandtone		Forest Green	
		Interior							
OAK								Left	Right
Left	Right	Left	Right	Left	Right	Left	Right	Left	Right
FWG50	59 1/4	By description		By description		By description		By description	
FWG60	71 1/4	By description		By description		By description		By description	
FWG80	95 1/4	By description		By description		By description		By description	
Jamb - Head / 2-Panel / Prefinished Interior White Ref. No. 1 <a href="#">page 127</a>									
Unit No.	Length	Exterior/Interior							
		White							
Left	Right	Left	Right	Left	Right	Left	Right	Left	Right
FWG50	59 1/4	By description		By description		By description		By description	
FWG60	71 1/4	By description		By description		By description		By description	
FWG80	95 1/4	By description		By description		By description		By description	

## 400 Series Frenchwood® Gliding Doors (1987 to Present)

*2-Panel, 4-Panel, and Stationary*

### Frames

#### Jamb - Head / 4-Panel / Pine Interior Ref. No. 1 [page 127](#)

**Note:**  
Support bracket is shipped with 16080 head jamb.

Unit No.	Length	Exterior			
		White	Terratone®	Sandtone	Forest Green
		Interior 			
FWG100	117	By description	By description	By description	By description
FWG120	141	By description	By description	By description	By description
FWG16068/160611	189	By description	By description	By description	By description
FWG16080	189	By description	By description	By description	By description

#### Jamb - Head / 4-Panel / Maple Interior Ref. No. 1 [page 127](#)

**Note:**  
Support bracket is shipped with 16080 head jamb.

Unit No.	Length	Exterior			
		White	Terratone®	Sandtone	Forest Green
		Interior 			
FWG100	117	By description	By description	By description	By description
FWG120	141	By description	By description	By description	By description
FWG16068	189	By description	By description	By description	By description
FWG16068/160611	189	By description	By description	By description	By description

#### Jamb - Head / 4-Panel / Oak Interior Ref. No. 1 [page 127](#)

**Note:**  
Support bracket is shipped with 16080 head jamb.

Unit No.	Length	Exterior			
		White	Terratone®	Sandtone	Forest Green
		Interior 			
FWG100	117	By description	By description	By description	By description
FWG120	141	By description	By description	By description	By description
FWG16068/160611	189	By description	By description	By description	By description
FWG16080	189	By description	By description	By description	By description

#### Jamb - Head / 4-Panel / Prefinished Interior White Ref. No. 1 [page 127](#)

**Note:**  
Support bracket is shipped with 16080 head jamb.

	Unit No.	Length	Exterior/Interior
			White
	FWG100	117	By description
	FWG120	141	By description
	FWG16068/160611	189	By description
	FWG16080	189	By description

## Frames

<b>Jamb - Operating / Side (May 2015 to Present)</b>									
<b>Note:</b> Jambs are handed as viewed from exterior. Side jambs are handed as unit is handed. As an example, a right-handed unit uses a right-handed operating side jamb and a right-handed stationary side jamb									
Unit No.	Length	White		Terratone®		Sandtone		Forest Green	
		Left	Right	Left	Right	Left	Right	Left	Right
<b>FWG68</b>	79 <sup>13</sup> / <sub>32</sub>	By description		By description		By description		By description	
<b>FWG611</b>	82 <sup>9</sup> / <sub>32</sub>	By description		By description		By description		By description	
<b>FWG80</b>	95 <sup>13</sup> / <sub>32</sub>	By description		By description		By description		By description	

<b>Jamb - Stationary / Side (May 2015 to Present) Ref. No. 9 <a href="#">page 127</a></b>									
<b>Note:</b> Jambs are handed as viewed from exterior. Side jambs are handed as unit is handed. As an example, a right-handed unit uses a right-handed operating side jamb and a right-handed stationary side jamb									
Unit No.	Length	White		Terratone®		Sandtone		Forest Green	
		Left	Right	Left	Right	Left	Right	Left	Right
<b>FWG68</b>	79 <sup>13</sup> / <sub>32</sub>	By description		By description		By description		By description	
<b>FWG611</b>	82 <sup>9</sup> / <sub>32</sub>	By description		By description		By description		By description	
<b>FWG80</b>	95 <sup>13</sup> / <sub>32</sub>	By description		By description		By description		By description	

<b>Jamb - Sidelight / Side (May 2015 to Present)</b>									
<b>Note:</b> Jambs are handed as viewed from exterior. Side jambs are handed as unit is handed. As an example, a sidelight unit uses a 1-left-handed stationary side jamb and 1 - right-handed stationary side jamb									
Unit No.	Length	White		Terratone®		Sandtone		Forest Green	
		Left	Right	Left	Right	Left	Right	Left	Right
<b>FWG68</b>	79 <sup>13</sup> / <sub>32</sub>	By description		By description		By description		By description	
<b>FWG611</b>	82 <sup>13</sup> / <sub>32</sub>	By description		By description		By description		By description	
<b>FWG80</b>	95 <sup>13</sup> / <sub>32</sub>	By description		By description		By description		By description	

<b>Trim Piece</b>						
<b>Trim Piece - Stationary / Side Jamb Ref. No. 10 <a href="#">page 126</a></b>						
	Unit No.	Length	Pine	Maple	Oak	White
	<b>FWG68</b>	77 <sup>5</sup> / <sub>64</sub>	2573010	2570372	2570366	9116349
	<b>FWG611</b>	79 <sup>61</sup> / <sub>64</sub>	2573011	2570373	2570367	9116350
	<b>FWG80</b>	93 <sup>5</sup> / <sub>64</sub>	2573016	2570374	2570368	9116351

<b>Trim Piece - Side Jamb / Stationary (Impact Resistant)</b>						
	Unit No.	Length	Pine	Maple	Oak	White
	<b>FWG68</b>	79 <sup>13</sup> / <sub>32</sub>	By description	By description	By description	By description
	<b>FWG611</b>	82 <sup>9</sup> / <sub>32</sub>	By description	By description	By description	By description
	<b>FWG80</b>	95 <sup>13</sup> / <sub>32</sub>	2565666	2565672	2565669	By description



# 400 Series Frenchwood® Gliding Doors (1987 to Present)

2-Panel, 4-Panel, and Stationary

## Frames

### Stops

#### Stop - Inside Head / White Ref. No. 4 [page 126](#)

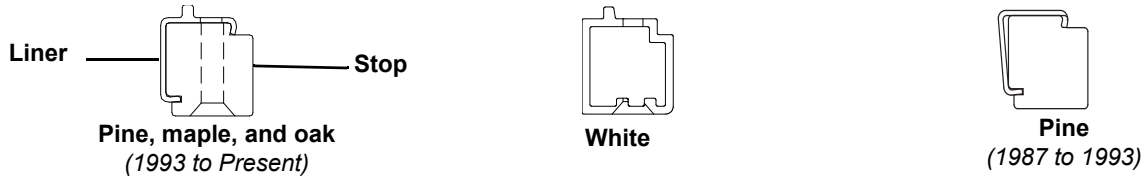

Unit No.	No. of Holes	Length	Pine (1987 to 1993)	Pine (1993 to Present)	Maple (1993 to Present)	Oak (1993 to Present)	White
FWG29	4	29 1/4	2572422	2572427	2572450	2572441	2572401
FWG33	5	35 1/4	2572418	2572428	2572451	2572442	2572402
FWG43	6	47 1/4	2572420	2572429	2572452	2572443	2572403
FWG50	7	56 15/32	2572424	2572430	2572453	2572444	2572404
FWG60	9	68 15/32	2572410	2572431	2572454	2572445	2572405
FWG80	12	92 15/32	2572412	2572432	2572455	2572446	2572406
FWG100	14	114 7/32	2572426	2572433	2572456	2572447	2572407
FWG120	17	138 7/32	2572414	2572434	2572457	2572448	2572408
FWG160	23	186 7/32	2572416	2572435	2572458	2572449	2572409

#### Stop - Inside Head / Gray Ref. No. 4 [page 126](#)

**Note:**

Use for Sandtone, Terratone®, Forest Green, Canvas, Dark Bronze and Black units.

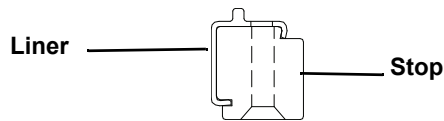

Pine, maple and oak (1993 to Present)

Unit No.	No. of Holes	Length	Pine (1987 to 1993)	Pine (1993 to Present)	Maple (1993 to Present)	Oak (1993 to Present)
FWG29	4	29 1/4	2653422	2653427	2653409	2653399
FWG33	5	35 1/4	2653418	2653428	2653411	2653401
FWG43	6	47 1/4	2653420	2653429	2653413	2653402
FWG50	7	56 15/32	2653424	2653430	2653415	2653403
FWG60	9	68 15/32	2653410	2653431	2653417	2653404
FWG80	12	92 15/32	2653412	2653432	2653419	2653405
FWG100	14	114 7/32	2653426	2653433	2653421	2653406
FWG120	17	138 7/32	2653414	2653434	2653423	2653407
FWG160	23	186 7/32	2653416	2653435	2653425	2653408

#### Screw - Inside Head Stop

**Note:**

Screws are included with frame screw package in hardware section. Zinc used with natural wood interior.

Description	Color	Order No.
1 1/2" x #8, F.H., Steel.	White	1973111
	Sandtone	0904110
	Terratone®	2653861
	Canvas	9046447
	Dark Bronze	9071814
	Black	9129188
	Zinc	2579823

## Frames

### Stops - Head Parting / Predrilled

**Note:**

Screws available individually. Custom size lengths are not available. Replaces previous vintage.

#### Stop - Head Parting / Sidelight

	<b>Unit No.</b>	<b>Fasteners/ Screw Used</b>	<b>Length</b>	<b>White</b>	<b>Gray</b>
	<b>GD29</b>	4	29 <sup>3</sup> / <sub>16</sub>	2572339	2653348
	<b>GD33</b>	5	35 <sup>3</sup> / <sub>16</sub>	2572340	2653349
	<b>GD43</b>	6	47 <sup>3</sup> / <sub>16</sub>	2572341	2653350

#### Stop - Head Parting / Predrilled / 2-Panel Ref. No. 3 [page 126](#)

	<b>Unit No.</b>	<b>Fasteners/ Screw Used</b>	<b>Length</b>	<b>White</b>	<b>Gray</b>
	<b>GD50</b>	7	56 <sup>7</sup> / <sub>16</sub>	1970919	2640519
	<b>GD60</b>	9	68 <sup>7</sup> / <sub>16</sub>	2572342	2653351
	<b>GD80</b>	12	92 <sup>7</sup> / <sub>16</sub>	2572343	2653352

#### Stop with Screws - Head Parting / Predrilled / 4-Panel Ref. No. 3 [page 126](#)

	<b>Unit No.</b>	<b>Fasteners/ Screw Used</b>	<b>Length</b>	<b>White</b>	<b>Gray</b>
	<b>GD100</b>	14	114 <sup>3</sup> / <sub>16</sub>	2572344	2653353
	<b>GD120</b>	17	138 <sup>3</sup> / <sub>16</sub>	2572345	2653354
	<b>GD160</b>	23	186 <sup>3</sup> / <sub>16</sub>	2572346	2653355

#### Screw - Head Parting Stop

	<b>Size</b>	<b>Color</b>	<b>Order No.</b>
	6-18 x 1 1/2 Type 17	White	2565702
		Gray	2653797

#### Parting Stop Bracket - DP Upgrade

	<b>Color</b>	<b>Order No.</b>
	Gray	2573692
	White	0912717

## 400 Series Frenchwood® Gliding Doors (1987 to Present)

*2-Panel, 4-Panel, and Stationary*

### Frames

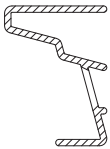
Stop - Outside Sidelight / Aluminum Ref. No. 21 <a href="#">page 126</a>						
	Unit No.	Length	White	Terratone®	Sandtone	Forest Green
	<b>FWG68</b>	77 <sup>3</sup> / <sub>16</sub>	2565661	2653154	0912222	1267842
	<b>FWG611</b>	80 <sup>1</sup> / <sub>16</sub>	2565662	2653155	0912223	1267843
	<b>FWG80</b>	93 <sup>3</sup> / <sub>16</sub>	2565663	2653156	0912224	1267844

Screw - Outside Sidelight Stop			
	Size	Color	Order No.
	8-15 x 3/4 Type 17 PH FH	White	2500706
		Terratone®	2653864
		Sandtone	0904112
		Forest Green	1269110

## Frames

Head Flashing						
Head Flashing - Sidelight						
	Unit No.	Length	White	Terratone®	Sandtone	Forest Green
	<b>FWG29</b>	32 <sup>3</sup> / <sub>32</sub>	2572504	2653506	0912402	1262718
	<b>FWG33</b>	38 <sup>3</sup> / <sub>32</sub>	2572506	2653518	0912404	1262719
	<b>FWG43</b>	50 <sup>3</sup> / <sub>32</sub>	2572508	2653520	0912406	1262720

Head Flashing - 2-Panel Ref. No. 5 <a href="#">page 126</a>						
	Unit No.	Length	White	Terratone®	Sandtone	Forest Green
	<b>FWG50</b>	59 <sup>11</sup> / <sub>32</sub>	1997277	2640720	0903510	By description
	<b>FWG60</b>	71 <sup>11</sup> / <sub>32</sub>	2572510	2653510	0912410	1262721
	<b>FWG80</b>	95 <sup>11</sup> / <sub>32</sub>	2572512	2653512	0912412	1262722

Head Flashing - 4-Panel Ref. No. 5 <a href="#">page 126</a>						
	Unit No.	Length	White	Terratone®	Sandtone	Forest Green
	<b>FWG100</b>	117 <sup>3</sup> / <sub>32</sub>	2572513	2653513	0912414	1262723
	<b>FWG120</b>	141 <sup>3</sup> / <sub>32</sub>	2572514	2653514	0912416	1262724
	<b>FWG160</b>	189 <sup>3</sup> / <sub>32</sub>	2572516	2653516	0912418	1262725

Installation Flanges			
Windbreak Flange - Head / Sidelight			
	Unit No.	Length	Gray
	<b>FWG29</b>	35 <sup>1</sup> / <sub>4</sub>	2572530
	<b>FWG33</b>	41 <sup>1</sup> / <sub>4</sub>	2572526
	<b>FWG43</b>	51 <sup>1</sup> / <sub>4</sub>	2572528

Windbreak Flange - Head / 2-Panel Ref. No. 6 <a href="#">page 126</a>			
	Unit No.	Length	Gray
	<b>FWG50</b>	62 <sup>3</sup> / <sub>8</sub>	2640708
	<b>FWG60</b>	74 <sup>3</sup> / <sub>8</sub>	2572518
	<b>FWG80</b>	98 <sup>3</sup> / <sub>8</sub>	2572520

Windbreak Flange - Head / 4-Panel Ref. No. 6 <a href="#">page 126</a>			
	Unit No.	Length	Gray
	<b>FWG100</b>	120 <sup>1</sup> / <sub>4</sub>	2572534
	<b>FWG120</b>	144 <sup>1</sup> / <sub>4</sub>	2572522
	<b>FWG160</b>	192 <sup>1</sup> / <sub>4</sub>	2572524

# 400 Series Frenchwood® Gliding Doors (1987 to Present)

2-Panel, 4-Panel, and Stationary

## Frames

Windbreak Flange - Side (Pair) Ref. No. 2 <a href="#">page 126</a>			
	Unit No.	Length	Gray
	<b>FWG68</b>	80 <sup>5</sup> / <sub>32</sub>	2550026
	<b>FWG611</b>	83 <sup>5</sup> / <sub>32</sub>	2427016
	<b>FWG80</b>	96 <sup>5</sup> / <sub>32</sub>	2572536

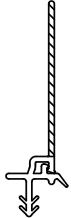
Flange - Folding / Head				
<b>Note:</b> Used with factory assembled units.				
	<b>Unit</b>	<b>Length</b>	<b>Order No.</b>	
			32	9044807
			38	9044808
			50	9044809
			59 <sup>1</sup> / <sub>4</sub>	9044803
			71 <sup>1</sup> / <sub>4</sub>	9044810
			95 <sup>1</sup> / <sub>4</sub>	9044811
			117	9044840
			141	9044841
			189	9044843

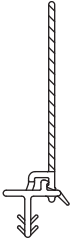
Flange - Folding / Side			
<b>Note:</b> Used with factory assembled units.			
	<b>Unit No.</b>	<b>Length</b>	<b>Order No.</b>
	<b>FWD68</b>	79 <sup>1</sup> / <sub>2</sub>	9044844
	<b>FWD611</b>	82 <sup>3</sup> / <sub>8</sub>	9044845
	<b>FWD76</b>	89 <sup>1</sup> / <sub>2</sub>	9046454
	<b>FWD80</b>	95 <sup>1</sup> / <sub>2</sub>	9044846
	<b>FWD100</b>	119 <sup>1</sup> / <sub>2</sub>	9044847

## Frames

### Insect Screen Guide

**Note:**

**Screws** available individually. Replaces previous vintage. Gray used for all colors not shown. Screen guide for custom sized doors is made to order. Product ID label is located on top edge of operating panel.

Aluminum screen guide is predrilled. PVC screen guide is not predrilled.

To order, state:

1. Description of part (Screen Guide)
2. Size
3. Unit No.
4. Quantity
5. Product ID (from product label, see [Service Guide 9051877](#))

#### Insect Screen Guide - PVC / Sidelight

	Unit No.	# Screw Holes	Length	White	Gray	Forest Green	Canvas	Dark Bronze	Black
	<b>FWG29</b>	-	30 1/8	2572621	2653621	1262755	9046422	9071809	9129953
	<b>FWG33</b>	-	36 1/8	2572622	2653622	1262756	9046423	9071810	9129954
	<b>FWG43</b>	-	48 1/8	2572624	2653624	1262757	9046424	9071811	9129955

#### Insect Screen Guide - Aluminum / 2-Panel

	Unit No.	# Screw Holes	Length	White	Gray	Forest Green	Canvas	Dark Bronze	Black
	<b>FWG50</b>	7	56 3/4	2562325	2641715	1262870	9135714	9135704	9129834
	<b>FWG60</b>	9	68 3/4	2562334	2641724	1262871	9135717	9135707	9129837
	<b>FWG80</b>	12	92 3/4	2562335	2641725	1262872	9135718	9135708	9129838

#### Insect Screen Guide - Aluminum / 4-Panel Ref. No. 7 [page 126](#)

	Unit No.	# Screw Holes	Length	White	Gray	Forest Green	Canvas	Dark Bronze	Black
	<b>FWG100</b>	14	114 1/16	2562336	2641726	1262873	9135719	9135709	9129839
	<b>FWG120</b>	17	138 1/16	2562337	2641727	1262874	9135720	9135710	9129840
	<b>FWG160</b>	23	186 1/16	2562338	2641728	1262875	9135721	9135711	9129841

#### Screw - Insect Screen Guide

Size	Color	Order No.
8-15 x 1 Flat HD Type 17	White	2500702
	Gray	2500704
	Forest Green	9135702
	Canvas	9135703
	Dark Bronze	9130522
	Black	9130530

# 400 Series Frenchwood® Gliding Doors (1987 to Present)

2-Panel, 4-Panel, and Stationary

## Frames

### Weatherstrip

**Note:** As of January 2004, Terratone®, Sandtone, and Forest Green weatherstrip is no longer available. Use Gray weatherstrip for replacement. May need to order vinyl to vinyl adhesive (part # 1357007 - 2 oz.). See [Weatherstrip Replacement Video](#).

Weatherstrip for custom sized doors is made to order. Product ID label is located on top edge of operating panel.

To order, state:

1. Description of part (Weatherstrip Set for Frame)
2. Handing (RH or LH)
3. Quantity
4. Product ID (from product label, see [Service Guide 9051877](#))

### Weatherstrip - Operating / Side Jamb / Outside Ref. No. 22 [page 126](#)

**Note:**

Requires 2 oz. tube (2) of vinyl adhesive (1357007).

	Unit No.	Length	White		Gray	
			Left	Right	Left	Right
	FWG68	77 <sup>57</sup> / <sub>64</sub>	2550021	2550046	2641416	2641417
	FWG611	80 <sup>49</sup> / <sub>64</sub>	1997109	1997110	2641418	2641419
	FWG80	93 <sup>57</sup> / <sub>64</sub>	2572930	2572931	2641420	2641421

### Weatherstrip - Operating / Side Jamb / Inside Ref. No. 22 [page 126](#)

**Note:**

Requires 2 oz. tube (1) of vinyl adhesive (1357007).

	Unit No.	Length	White	Gray
	FWG68	76 <sup>21</sup> / <sub>32</sub>	2550020	2641410
FWG611	79 <sup>17</sup> / <sub>32</sub>	1997108	2641411	
FWG80	92 <sup>21</sup> / <sub>32</sub>	2572929	2641412	

### Weatherstrip - Stationary / Side Jamb / Inside Ref. No. 12 [page 126](#)

**Note:**

Requires 2 oz. tube (1) of vinyl adhesive (1357007).

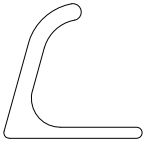
	Unit No.	Length	White	Gray
	FWG68	77 <sup>13</sup> / <sub>16</sub>	2572926	2641413
FWG68 Repl 87	77 <sup>13</sup> / <sub>16</sub>	2572925	N/A	
FWG611	80 <sup>11</sup> / <sub>16</sub>	2572904	2641414	
FWG80	93 <sup>13</sup> / <sub>16</sub>	2572928	2641415	

### Weatherstrip - Sidelight / Side Jamb

**Note:**

Requires 2 oz. tube (1) of vinyl adhesive (1357007).

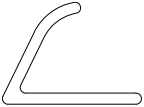
	Unit No.	Length	White	Gray
	FWG68	77 <sup>13</sup> / <sub>16</sub>	2550022	2641425
FWG80	93 <sup>13</sup> / <sub>16</sub>	2572927	2641427	

## Frames

### Sills

**Note:**

Replacement sills are **not** available for units made prior to May 1, 2015. Full frame assembly must be replaced. Sills for custom sized doors are made to order. Product ID label is located on top edge of operating panel.

To order, state:

1. Description of part (Sill)
2. Handing (RH or LH)
3. Quantity
4. Product ID (from product label, see [Service Guide 9051877](#))

#### Complete Sill - Sidelight (May 2015 to Present)

	Unit No.	Length	Aluminum	Gray
	<b>FWG29</b>	32	9131953	9131965
	<b>FWG33</b>	38	9131951	9131963
	<b>FWG43</b>	50	9131952	9131964

#### Complete Sill - 2-Panel (May 2015 to Present)

**Note:**

Database descriptions may be confusing.

	Unit No.	Length	Mill Finish (Aluminum)		Spatter Coat Finish (Gray)			
			White (Filler Color)		Gray (Filler Color)		White (Filler Color)	
			Left	Right	Left	Right	Left	Right
	<b>FWG50</b>	59 1/4	9131932	9131933	9131966	9131967	9131954	9131955
	<b>FWG60</b>	71 1/4	9131934	9131935	9131957	9131958	9131945	9131946
	<b>FWG80</b>	95 1/4	9131936	9131937	9131959	9131960	9131947	9131948

#### Complete Sill - 4-Panel (May 2015 to Present) Ref. No. 13 [page 126](#)

	Unit No.	Length	Aluminum	Gray
	<b>FWG100</b>	117	9131956	9131968
	<b>FWG120</b>	141	9131949	9131961
	<b>FWG160</b>	189	9131950	9131962

#### Sill Track Cap - 2-Panel Ref. No. 16 [page 126](#)

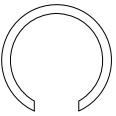
	Unit No.	Order No.
	<b>FWG50</b>	2573627
	<b>FWG60</b>	2573628
	<b>FWG80</b>	2573630

#### Sill Track Cap - 4-Panel Ref. No. 16 [page 126](#)

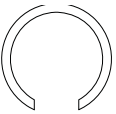
	Unit No.	Order No.
	<b>FWG100</b>	2573631
	<b>FWG120</b>	2573632
	<b>FWG160</b>	2573634



# 400 Series Frenchwood® Gliding Doors (1987 to Present)

2-Panel, 4-Panel, and Stationary

## Frames

Sill Support with Screws Ref. No. 17 <a href="#">page 126</a>		
	Order No.	Gray
	PD30	1997055
	PD40	1997056
	PD50	1997054
	PD60	1997057
	PD80	1997058
	PD90	1997059
	PD100	2573218
	PD120	1997060
	PD160	2573216
	PD510	2550011

## Frames

### Filler

**Note:**

Terratone® and Sandtone filler are no longer available. Use gray for Terratone® and Sandtone units.

#### Filler with Screws - Sidelight / Bottom Rail

	Unit No.	Length	White	Gray
	<b>FWG29</b>	30"	N/A	2402057
	<b>FWG33</b>	36"	8293601	8293602
	<b>FWG43</b>	48"	8293603	8293604

#### Filler with Screws - Stationary / Bottom Rail Ref. No. 14 [page 126](#)

Unit No.	Dimensions	White		Gray	
		Left	Right	Left	Right
<b>GD26</b>	29 <sup>7</sup> / <sub>8</sub>	2572704	2572706	0912608	0912610
<b>GD30/FWG30</b>	35 <sup>7</sup> / <sub>8</sub>	2572708	2572710	0912612	0912614
<b>GD40/FWG40</b>	47 <sup>7</sup> / <sub>8</sub>	2572712	2572714	0912616	0912618

#### End Cap - Bottom Rail Filler

	<b>Note:</b> Gray used as replacement for Sandtone and Forest Green.	Color	Order No.	
			Left	Right
		White	2573870	2573872
		Terratone®	2653840	2653842
Gray	1997025	1997026		

#### Retainer - Rail Filler / Center Ref. No. 15 [page 126](#)

	<b>Note:</b> Replace with bottom rail filler shown above.	Order No.
		N/A

#### Retainer - Rail Filler / Center Ref. No. 15 [page 126](#)

	<b>Note:</b> Replace with bottom rail filler shown above.	Order No.
		N/A

#### Panel Snugger with Washer

		Natural
		1913005

# 400 Series Frenchwood® Gliding Doors (1987 to Present)

2-Panel, 4-Panel, and Stationary

## Frames

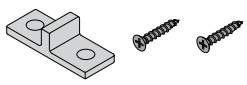
Bracket - 4 Panel			
Operating Panel Channel Bracket / 4-Panel			
<b>Note:</b> See <a href="#">Service Guide 9183859</a> .			
	<b>Kit Includes:</b> (1) Bracket (2) #8 x 1" FH screws	<b>Color</b>	<b>Order No.</b>
		White	9183990
		Gray	9183991

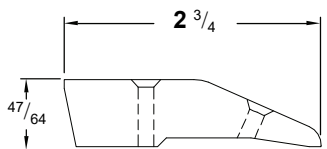
Frame Parts and Hardware				
Threshold with Screws Ref. No. 19 <a href="#">page 126</a>				
	<b>Unit No.</b>	<b>Length</b>	<b>Maple</b>	<b>Oak</b>
	FWG29/30/33	40"	1207056	1207010
	FWG43	52"	1207057	1207020
	FWG50	63"	1207058	1207025
	FWG60	74"	1207059	1207030
	FWG80	98"	1207060	1207040
	FWG100//4	120"	1207062	1207048
	FWG120/4	145"	1207063	1207050
	FWG160/4	193"	1207064	1207055

Screw Package - Threshold / 3/4		
	<b>Package Includes:</b> (3) screws	<b>Order No.</b> 1277102
Screw Package - Threshold / 5/6		
	<b>Package Includes:</b> (5) screws	<b>Order No.</b> 1277104
Screw Package - Threshold / 8/9		
	<b>Package Includes:</b> (7) screws	<b>Order No.</b> 1277106
Screw Package - Threshold / 10/12		
	<b>Package Includes:</b> (9) screws	<b>Order No.</b> 1277108
Screw Package - Threshold / 15		
	<b>Package Includes:</b> (13) screws	<b>Order No.</b> 1277110

## Frames

Plug - Sill (May 2015 to Present)			
	<b>Note:</b> Use foam plug at bottom of interlock.	<b>Left</b>	<b>Right</b>
		9131969	9131970

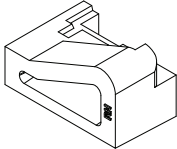
Plug - Sill (1990 to May 2015)			
	<b>Note:</b> Replace with current sill plug.	<b>Left</b>	<b>Right</b>
		N/A	N/A

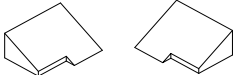
Plug - Operator Side Jamb Ref. No. 11 <a href="#">page 126</a>			
		<b>Left</b>	<b>Right</b>
		2640832	2640834

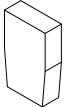
Foam Block - Parting Stop End		
	<b>Note:</b> Use on end of lock jamb.	<b>Order No.</b>
		2573626

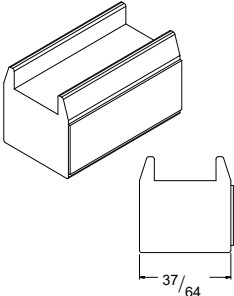
Plug - Head Foam (January 2009 to Present)		
	<b>Note:</b> Use on top of interlock weatherstrip on stationary panel. Used on factory assembled units.	<b>Order No.</b>
		9131892

Plug - Head Foam (1987 - December 2008)		
	<b>Note:</b> Use on top of interlock weatherstrip on stationary panel.	<b>Order No.</b>
		2573624

# 400 Series Frenchwood® Gliding Doors (1987 to Present)

2-Panel, 4-Panel, and Stationary

## Frames

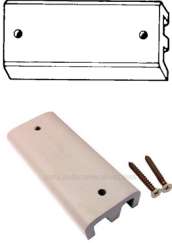
Head Bumper with Screws - 2-Panel			
	<b>Note:</b> Use on 4-panels units also.	<b>Color</b>	<b>Order No.</b>
		White	1997083
		Gray	2640012

Cartons		
Cartons - Unit		
<b>Note:</b> To ship via van only.	<b>Unit No.</b>	<b>Order No.</b>
	FWG/FWH 5068/611	4757498
	FWG/FWH 6068/611	4757500
	FWG/FWH 8068/611	4757503

## Frames

### Extension Jamb

**Note:**



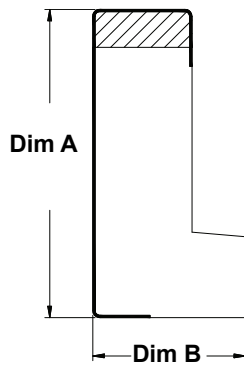

See [Accessory Guide 0005474](#).



Size	Dim A	Dim B
5 1/4	47/64	1
6 9/16	2 1/32	1
7 1/8	2 19/32	1

### Extension Jamb Kits



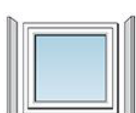

#### Extension Jamb Kits

	Head (One, Two and Four Panel)	Side
 PINE		
 MAPLE		
 OAK		
 WHITE		
<b>White Vinyl</b>		

# 400 Series Frenchwood® Gliding Doors (1987 to Present)



*2-Panel, 4-Panel, and Stationary*

## Frames

Extension Jamb / Wood / Head Jamb / Pine											
											
Wall Depth	Dim A	Stationary			2 Panel			4 Panel			
		29	33	43	50	60	80	100	120	160	
<b>5"</b>	<b>5</b>	$15/32$	N/A	N/A	N/A	N/A	N/A	N/A	N/A	N/A	N/A
	<b>5 1/16</b>	$17/32$	9106952	9106953	9106954	9106955	9106956	9106957	9106958	9106959	9105960
	<b>5 1/8</b>	$19/32$	9107012	9107013	9107014	9107015	9107016	9107017	9107018	9107019	9107020
	<b>5 3/16</b>	$21/32$	9107072	9107073	9107074	9107075	9107076	9107077	9107078	9107079	9107080
	<b>5 1/4</b>	$23/32$	2567213	2567214	2567215	2567216	2567217	2567218	2567219	2567220	2567221
	<b>5 5/16</b>	$25/32$	9107132	9107133	9107134	9107135	9107136	9107137	9107138	9107139	9107140
	<b>5 3/8</b>	$27/32$	9107192	9107193	9107194	9107195	9107196	9107197	9107198	9107199	9107200
	<b>5 7/16</b>	$29/32$	9107252	9107253	9107254	9107255	9107256	9107257	9107258	9107259	9107260
	<b>5 1/2</b>	$31/32$	9107312	9107313	9107314	9107315	9107316	9107317	9107318	9107319	9107320
	<b>5 9/16</b>	$1 1/32$	9107372	9107373	9107374	9107375	9107376	9107377	9107378	9107379	9107380
	<b>5 5/8</b>	$1 3/32$	9107432	9107433	9107434	9107435	9107436	9107437	9107438	9107439	9107440
	<b>5 11/16</b>	$1 5/32$	9107492	9107493	9107494	9107495	9107496	9107497	9107498	9107499	9107500
	<b>5 3/4</b>	$1 7/32$	9107552	9107553	9107554	9107555	9107556	9107557	9107558	9107559	9107560
	<b>5 13/16</b>	$1 9/32$	9107612	9107613	9107614	9107615	9107616	9107617	9107618	9107619	9107620
<b>5 7/8</b>	$1 11/32$	9107672	9107673	9107674	9107675	9107676	9107677	9107678	9107679	9107680	
<b>5 15/16</b>	$1 13/32$	9107732	9107733	9107734	9107735	9107736	9107737	9107738	9107739	9107740	
<b>6"</b>	<b>6</b>	$1 15/32$	9107792	9107793	9107794	9107795	9107796	9107797	9107798	9107799	9107800
	<b>6 1/16</b>	$1 17/32$	9107852	9107853	9107854	9107855	9107856	9107857	9107858	9107859	9107860
	<b>6 1/8</b>	$1 19/32$	9107912	9107913	9107914	9107915	9107916	9107917	9107918	9107919	9107920
	<b>6 3/16</b>	$1 21/32$	9107972	9107973	9107974	9107975	9107976	9107977	9107978	9107979	9107980
	<b>6 1/4</b>	$1 23/32$	9108032	9108033	9108034	9108035	9108036	9108037	9108038	9108039	9108040
	<b>6 5/16</b>	$1 25/32$	9108092	9108093	9108094	9108095	9108096	9108097	9108098	9108099	9108100
	<b>6 3/8</b>	$1 27/32$	9108152	9108153	9108154	9108155	9108156	9108157	9108158	9108159	9108160
	<b>6 7/16</b>	$1 29/32$	9108212	9108213	9108214	9108215	9108216	9108217	9108218	9108219	9108220
	<b>6 1/2</b>	$1 31/32$	9108272	9108273	9108274	9108275	9108276	9108277	9108278	9108279	9108280
	<b>6 9/16</b>	$2 1/32$	2567222	2567223	2567224	2567225	2567226	2567227	2567228	2567229	2567230
	<b>6 5/8</b>	$2 3/32$	9108332	9108333	9108334	9108335	9108336	9108337	9108338	9108339	9108340
	<b>6 11/16</b>	$2 5/32$	9108392	9108393	9108394	9108395	9108396	9108397	9108398	9108399	9108400
	<b>6 3/4</b>	$2 7/32$	9108452	9108453	9108454	9108455	9108456	9108457	9108458	9108459	9108460
	<b>6 13/16</b>	$2 9/32$	9108512	9108513	9108514	9108515	9108516	9108517	9108518	9108519	9108520
<b>6 7/8</b>	$2 11/32$	9108572	9108573	9108574	9108575	9108576	9108577	9108578	9108579	9108580	
<b>6 15/16</b>	$2 13/32$	9108632	9108633	9108634	9108635	9108636	9108637	9108638	9108639	9108640	
<b>7"</b>	<b>7</b>	$2 15/32$	9108692	9108693	9108694	9108695	9108696	9108697	9108698	9108699	9108700
	<b>7 1/16</b>	$2 17/32$	9108752	9108753	9108754	9108755	9108756	9108757	9108758	9108759	9108760
	<b>7 1/8</b>	$2 19/32$	2567231	2567232	2567233	2567234	2567235	2567236	2567237	2567238	2567239

**Frames**

**Extension Jamb / Wood / Side Jamb / Pine**





									
				<b>68</b>		<b>611</b>		<b>80</b>	
		<b>Wall Depth</b>	<b>Dim A</b>						
<b>5"</b>	<b>5</b>		$15/32$						
	<b>5 1/16</b>		$17/32$	9106997		9106998		9106999	
	<b>5 1/8</b>		$19/32$	9107057		9107058		9107059	
	<b>5 3/16</b>		$21/32$	9107117		9107118		9107119	
	<b>5 1/4</b>		$23/32$	2567349		2567350		2567351	
	<b>5 5/16</b>		$25/32$	9107177		9107178		9107179	
	<b>5 3/8</b>		$27/32$	9107237		9107238		9107239	
	<b>5 7/16</b>		$29/32$	9107297		9107298		9107299	
	<b>5 1/2</b>		$31/32$	9107357		9107358		9107359	
	<b>5 9/16</b>	<b>1 1/32</b>		9107417		9107418		9107419	
	<b>5 5/8</b>	<b>1 3/32</b>		9107477		9107478		9107479	
	<b>5 11/16</b>	<b>1 5/32</b>		9107537		9107538		9107539	
	<b>5 3/4</b>	<b>1 7/32</b>		9107597		9107598		9107599	
	<b>5 13/16</b>	<b>1 9/32</b>		9107657		9107658		9107659	
	<b>5 7/8</b>	<b>1 11/32</b>		9107717		9107718		9107719	
<b>5 15/16</b>	<b>1 13/32</b>		9107777		9107778		9107779		
<b>6"</b>	<b>6</b>	<b>1 15/32</b>		9107837		9107838		9107839	
	<b>6 1/16</b>	<b>1 17/32</b>		9107897		9107898		9107899	
	<b>6 1/8</b>	<b>1 19/32</b>		9107957		9107958		9107959	
	<b>6 3/16</b>	<b>1 21/32</b>		9108017		9108018		9108019	
	<b>6 1/4</b>	<b>1 23/32</b>		9108077		9108078		9108079	
	<b>6 5/16</b>	<b>1 25/32</b>		9108137		9108138		9108139	
	<b>6 3/8</b>	<b>1 27/32</b>		9108197		9108198		9108199	
	<b>6 7/16</b>	<b>1 29/32</b>		9108257		9108258		9108259	
	<b>6 1/2</b>	<b>1 31/32</b>		9108317		9108318		9108319	
	<b>6 9/16</b>	<b>2 1/32</b>		2567364		2567365		2567366	
	<b>6 5/8</b>	<b>2 3/32</b>		9108377		9108378		9108379	
	<b>6 11/16</b>	<b>2 5/32</b>		9108437		9108438		9108439	
	<b>6 3/4</b>	<b>2 7/32</b>		9108497		9108498		9108499	
	<b>6 13/16</b>	<b>2 9/32</b>		9108557		9108558		9108559	
	<b>6 7/8</b>	<b>2 11/32</b>		9108617		9108618		9108619	
<b>6 15/16</b>	<b>2 13/32</b>		9108677		9108678		9108679		
<b>7"</b>	<b>7</b>	<b>2 15/32</b>		9108737		9108738		9108739	
	<b>7 1/16</b>	<b>2 17/32</b>		9108797		9108798		9108799	
	<b>7 1/8</b>	<b>2 19/32</b>		2567379		2567380		2567381	



# 400 Series Frenchwood® Gliding Doors (1987 to Present)



*2-Panel, 4-Panel, and Stationary*

## Frames

Extension Jamb / Wood / Head Jamb / Maple											
 MAPLE											
Wall Depth	Dim A	Stationary/			2 Panel			4 Panel			
		29	33	43	50	60	80	100	120	160	
<b>5"</b>	<b>5</b>	$15/32$	N/A	N/A	N/A	N/A	N/A	N/A	N/A	N/A	N/A
	$5 \ 1/16$	$17/32$	9106970	9106971	9106972	9106973	9106974	9106975	9106976	9106977	9106978
	$5 \ 1/8$	$19/32$	9107030	9107031	9107032	9107033	9107034	9107035	9107036	9107037	9107038
	$5 \ 3/16$	$21/32$	9107090	9107091	9107092	9107093	9107094	9107095	9107096	9107097	9107098
	$5 \ 1/4$	$23/32$	2567267	2567268	2567269	2567270	2567271	2567272	2567273	2567274	2567275
	$5 \ 5/16$	$25/32$	9107150	9107151	9107152	9107153	9107154	9107155	9107156	9107157	9107158
	$5 \ 3/8$	$27/32$	9107210	9107211	9107212	9107213	9107214	9107215	9107216	9107217	9107218
	$5 \ 7/16$	$29/32$	9107270	9107271	9107272	9107273	9107274	9107275	9107276	9107277	9107278
	$5 \ 1/2$	$31/32$	9107330	9107331	9107332	9107333	9107334	9107335	9107336	9107337	9107338
	$5 \ 9/16$	$1 \ 1/32$	9107390	9107391	9107392	9107393	9107394	9107395	9107396	9107397	9107398
	$5 \ 5/8$	$1 \ 3/32$	9107450	9107451	9107452	9107453	9107454	9107455	9107456	9107457	9107458
	$5 \ 11/16$	$1 \ 5/32$	9107510	9107511	9107512	9107513	9107514	9107515	9107516	9107517	9107518
	$5 \ 3/4$	$1 \ 7/32$	9107570	9107571	9107572	9107573	9107574	9107575	9107576	9107577	9107578
	$5 \ 13/16$	$1 \ 9/32$	9107630	9107631	9107632	9107633	9107634	9107635	9107636	9107637	9107638
	$5 \ 7/8$	$1 \ 11/32$	9107690	9107691	9107692	9107693	9107694	9107695	9107696	9107697	9107698
$5 \ 15/16$	$1 \ 13/32$	9107750	9107751	9107752	9107753	9107754	9107755	9107756	9107757	9107758	
<b>6"</b>	<b>6</b>	$1 \ 15/32$	9107810	9107811	9107812	9107813	9107814	9107815	9107816	9107817	9107818
	$6 \ 1/16$	$1 \ 17/32$	9107870	9107871	9107872	9107873	9107874	9107875	9107876	9107877	9107878
	$6 \ 1/8$	$1 \ 19/32$	9107930	9107931	9107932	9107933	9107934	9107935	9107936	9107937	9107938
	$6 \ 3/16$	$1 \ 21/32$	9107990	9107991	9107992	9107993	9107994	9107995	9107996	9107997	9107998
	$6 \ 1/4$	$1 \ 23/32$	9108050	9108051	9108052	9108053	9108054	9108055	9108056	9108057	9108058
	$6 \ 5/16$	$1 \ 25/32$	9108110	9108111	9108112	9108113	9108114	9108115	9108116	9108117	9108118
	$6 \ 3/8$	$1 \ 27/32$	9108170	9108171	9108172	9108173	9108174	9108175	9108176	9108177	9108178
	$6 \ 7/16$	$1 \ 29/32$	9108230	9108231	9108232	9108233	9108234	9108235	9108236	9108237	9108238
	$6 \ 1/2$	$1 \ 31/32$	9108290	9108291	9108292	9108293	9108294	9108295	9108296	9108297	9108298
	$6 \ 9/16$	$2 \ 1/32$	2567276	2567277	2567278	2567279	2567280	2567281	2567282	2567283	2567284
	$6 \ 5/8$	$2 \ 3/32$	9108350	9108351	9108352	9108353	9108354	9108355	9108356	9108357	9108358
	$6 \ 11/16$	$2 \ 5/32$	9108410	9108411	9108412	9108413	9108414	9108415	9108416	9108417	9108418
	$6 \ 3/4$	$2 \ 7/32$	9108470	9108471	9108472	9108473	9108474	9108475	9108476	9108477	9108478
	$6 \ 13/16$	$2 \ 9/32$	9108530	9108531	9108532	9108533	9108534	9108535	9108536	9108537	9108538
	$6 \ 7/8$	$2 \ 11/32$	9108590	9108591	9108592	9108593	9108594	9108595	9108596	9108597	9108598
$6 \ 15/16$	$2 \ 13/32$	9108650	9108651	9108652	9108653	9108654	9108655	9108656	9108657	9108658	
<b>7"</b>	<b>7</b>	$2 \ 15/32$	9108710	9108711	9108712	9108713	9108714	9108715	9108716	9108717	9108718
	$7 \ 1/16$	$2 \ 17/32$	9108770	9108771	9108772	9108773	9108774	9108775	9108776	9108777	9108778
	$7 \ 1/8$	$2 \ 19/32$	2567285	2567286	2567287	2567288	2567289	2567290	2567291	2567292	2567293

**Frames**





**Extension Jamb / Wood / Side Jamb / Maple**

									
<b>Wall Depth</b>		<b>Dim A</b>	<b>68</b>	<b>611</b>	<b>80</b>				
<b>5"</b>	<b>5</b>	1 <sup>15</sup> / <sub>32</sub>							
	<b>5 1/16</b>	1 <sup>17</sup> / <sub>32</sub>	9107003	9107004	9107005				
	<b>5 1/8</b>	1 <sup>19</sup> / <sub>32</sub>	9107063	9107064	9107065				
	<b>5 3/16</b>	2 <sup>1</sup> / <sub>32</sub>	9107123	9107124	9107125				
	<b>5 1/4</b>	2 <sup>3</sup> / <sub>32</sub>	2567355	2567356	2567357				
	<b>5 5/16</b>	2 <sup>5</sup> / <sub>32</sub>	9107183	9107184	9107185				
	<b>5 3/8</b>	2 <sup>7</sup> / <sub>32</sub>	9107243	9107244	9107245				
	<b>5 7/16</b>	2 <sup>9</sup> / <sub>32</sub>	9107303	9107304	9107305				
	<b>5 1/2</b>	3 <sup>1</sup> / <sub>32</sub>	9107363	9107364	9107365				
	<b>5 9/16</b>	1 1 <sup>1</sup> / <sub>32</sub>	9107423	9107424	9107425				
	<b>5 5/8</b>	1 3 <sup>1</sup> / <sub>32</sub>	9107483	9107484	9107485				
	<b>5 11/16</b>	1 5 <sup>1</sup> / <sub>32</sub>	9107543	9107544	9107545				
	<b>5 3/4</b>	1 7 <sup>1</sup> / <sub>32</sub>	9107603	9107604	9107605				
	<b>5 13/16</b>	1 9 <sup>1</sup> / <sub>32</sub>	9107663	9107664	9107665				
	<b>5 7/8</b>	1 11 <sup>1</sup> / <sub>32</sub>	9107723	9107724	9107725				
<b>5 15/16</b>	1 13 <sup>1</sup> / <sub>32</sub>	9107783	9107784	9107785					
<b>6"</b>	<b>6</b>	1 15 <sup>1</sup> / <sub>32</sub>	9107843	9107844	9107845				
	<b>6 1/16</b>	1 17 <sup>1</sup> / <sub>32</sub>	9107903	9107904	9107905				
	<b>6 1/8</b>	1 19 <sup>1</sup> / <sub>32</sub>	9107963	9107964	9107965				
	<b>6 3/16</b>	1 21 <sup>1</sup> / <sub>32</sub>	9108023	9108024	9108025				
	<b>6 1/4</b>	1 23 <sup>1</sup> / <sub>32</sub>	9108083	9108084	9108085				
	<b>6 5/16</b>	1 25 <sup>1</sup> / <sub>32</sub>	9108143	9108144	9108145				
	<b>6 3/8</b>	1 27 <sup>1</sup> / <sub>32</sub>	9108203	9108204	9108205				
	<b>6 7/16</b>	1 29 <sup>1</sup> / <sub>32</sub>	9108263	9108264	9108265				
	<b>6 1/2</b>	1 31 <sup>1</sup> / <sub>32</sub>	9108323	9108324	9108325				
	<b>6 9/16</b>	2 1 <sup>1</sup> / <sub>32</sub>	2567370	2567371	2567372				
	<b>6 5/8</b>	2 3 <sup>1</sup> / <sub>32</sub>	9108383	9108384	9108385				
	<b>6 11/16</b>	2 5 <sup>1</sup> / <sub>32</sub>	9108443	9108444	9108445				
	<b>6 3/4</b>	2 7 <sup>1</sup> / <sub>32</sub>	9108503	9108504	9108505				
	<b>6 13/16</b>	2 9 <sup>1</sup> / <sub>32</sub>	9108563	9108564	9108565				
	<b>6 7/8</b>	2 11 <sup>1</sup> / <sub>32</sub>	9108623	9108624	9108625				
<b>6 15/16</b>	2 13 <sup>1</sup> / <sub>32</sub>	9108683	9108684	9108685					
<b>7"</b>	<b>7</b>	2 15 <sup>1</sup> / <sub>32</sub>	9108743	9108744	9108745				
	<b>7 1/16</b>	2 17 <sup>1</sup> / <sub>32</sub>	9108803	9108804	9108805				
	<b>7 1/8</b>	2 19 <sup>1</sup> / <sub>32</sub>	2567385	2567386	2567387				

# 400 Series Frenchwood® Gliding Doors (1987 to Present)

*2-Panel, 4-Panel, and Stationary*

## Frames

Extension Jamb / Wood / Head Jamb / Oak											
											
Wall Depth	Dim A	Stationary			2 Panel			4 Panel			
		29	33	43	50	60	80	100	120	160	
<b>5"</b>	<b>5</b>	<sup>15</sup> / <sub>32</sub>	N/A	N/A	N/A	N/A	N/A	N/A	N/A	N/A	N/A
	<b>5 1/16</b>	<sup>17</sup> / <sub>32</sub>	9106961	9106962	9106963	9106964	9106965	9106966	9106967	9106968	9106969
	<b>5 1/8</b>	<sup>19</sup> / <sub>32</sub>	9107021	9107022	9107023	9107024	9107025	9107026	9107027	9107028	9107029
	<b>5 3/16</b>	<sup>21</sup> / <sub>32</sub>	9107081	9107082	9107083	9107084	9107085	9107086	9107087	9107088	9107089
	<b>5 1/4</b>	<sup>23</sup> / <sub>32</sub>	2567240	2567241	2567242	2567243	2567244	2567245	2567246	2567247	2567248
	<b>5 5/16</b>	<sup>25</sup> / <sub>32</sub>	9107141	9107142	9107143	9107144	9107145	9107146	9107147	9107148	9107149
	<b>5 3/8</b>	<sup>27</sup> / <sub>32</sub>	9107201	9107202	9107203	9107204	9107205	9107206	9107207	9107208	9107209
	<b>5 7/16</b>	<sup>29</sup> / <sub>32</sub>	9107261	9107262	9107263	9107264	9107265	9107266	9107267	9107268	9107269
	<b>5 1/2</b>	<sup>31</sup> / <sub>32</sub>	9107321	9107322	9107323	9107324	9107325	9107326	9107327	9107328	9107329
	<b>5 9/16</b>	<b>1 1/32</b>	9107381	9107382	9107383	9107384	9107385	9107386	9107387	9107388	9107389
	<b>5 5/8</b>	<b>1 3/32</b>	9107441	9107442	9107443	9107444	9107445	9107446	9107447	9107448	9107449
	<b>5 11/16</b>	<b>1 5/32</b>	9107501	9107502	9107503	9107504	9107505	9107506	9107507	9107508	9107509
	<b>5 3/4</b>	<b>1 7/32</b>	9107561	9107562	9107563	9107564	9107565	9107566	9107567	9107568	9107569
	<b>5 13/16</b>	<b>1 9/32</b>	9107621	9107622	9107623	9107624	9107625	9107626	9107627	9107628	9107629
	<b>5 7/8</b>	<b>1 11/32</b>	9107681	9107682	9107683	9107684	9107685	9107686	9107687	9107688	9107689
<b>5 15/16</b>	<b>1 13/32</b>	9107741	9107742	9107743	9107744	9107745	9107746	9107747	9107748	9107749	
<b>6"</b>	<b>6</b>	<b>1 15/32</b>	9107801	9107802	9107803	9107804	9107805	9107806	9107807	9107808	9107809
	<b>6 1/16</b>	<b>1 17/32</b>	9107861	9107862	9107863	9107864	9107865	9107866	9107867	9107868	9107869
	<b>6 1/8</b>	<b>1 19/32</b>	9107921	9107922	9107923	9107924	9107925	9107926	9107927	9107928	9107929
	<b>6 3/16</b>	<b>1 21/32</b>	9107981	9107982	9107983	9107984	9107985	9107986	9107987	9107988	9107989
	<b>6 1/4</b>	<b>1 23/32</b>	9108041	9108042	9108043	9108044	9108045	9108046	9108047	9108048	9108049
	<b>6 5/16</b>	<b>1 25/32</b>	9108101	9108102	9108103	9108104	9108105	9108106	9108107	9108108	9108109
	<b>6 3/8</b>	<b>1 27/32</b>	9108161	9108162	9108163	9108164	9108165	9108166	9108167	9108168	9108169
	<b>6 7/16</b>	<b>1 29/32</b>	9108221	9108222	9108223	9108224	9108225	9108226	9108227	9108228	9108229
	<b>6 1/2</b>	<b>1 31/32</b>	9108281	9108282	9108283	9108284	9108285	9108286	9108287	9108288	9108289
	<b>6 9/16</b>	<b>2 1/32</b>	2567249	2567250	2567251	2567252	2567253	2567254	2567255	2567256	2567257
	<b>6 5/8</b>	<b>2 3/32</b>	9108341	9108342	9108343	9108344	9108345	9108346	9108347	9108348	9108349
	<b>6 11/16</b>	<b>2 5/32</b>	9108401	9108402	9108403	9108404	9108405	9108406	9108407	9108408	9108409
	<b>6 3/4</b>	<b>2 7/32</b>	9108461	9108462	9108463	9108464	9108465	9108466	9108467	9108468	9108469
	<b>6 13/16</b>	<b>2 9/32</b>	9108521	9108522	9108523	9108524	9108525	9108526	9108527	9108528	9108529
	<b>6 7/8</b>	<b>2 11/32</b>	9108581	9108582	9108583	9108584	9108585	9108586	9108587	9108588	9108589
<b>6 15/16</b>	<b>2 13/32</b>	9108641	9108642	9108643	9108644	9108645	9108646	9108647	9108648	9108649	
<b>7"</b>	<b>7</b>	<b>2 15/32</b>	9108701	9108702	9108703	9108704	9108705	9108706	9108707	9108708	9108709
	<b>7 1/16</b>	<b>2 17/32</b>	9108761	9108762	9108763	9108764	9108765	9108766	9108767	9108768	9108769
	<b>7 1/8</b>	<b>2 19/32</b>	2567258	2567259	2567260	2567261	2567262	2567263	2567264	2567265	2567266



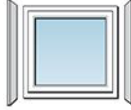

### Frames

Extension Jamb / Wood / Side Jamb / Oak					
					
Wall Depth	Dim A	68	611	80	
<b>5"</b>	5	15/32			
	5 1/16	17/32	9107000	9107001	9107002
	5 1/8	19/32	9107060	9107061	9107062
	5 3/16	21/32	9107120	9107121	9107122
	5 1/4	23/32	2567352	2567353	2567354
	5 5/16	25/32	9107180	9107181	9107182
	5 3/8	27/32	9107240	9107241	9107242
	5 7/16	29/32	9107300	9107301	9107302
	5 1/2	31/32	9107360	9107361	9107362
	5 9/16	1 1/32	9107420	9107421	9107422
	5 5/8	1 3/32	9107480	9107481	9107482
	5 11/16	1 5/32	9107540	9107541	9107542
	5 3/4	1 7/32	9107600	9107601	9107602
	5 13/16	1 9/32	9107660	9107661	9107662
	5 7/8	1 11/32	9107720	9107721	9107722
5 15/16	1 13/32	9107780	9107781	9107782	
<b>6"</b>	6	1 15/32	9107840	9107841	9107842
	6 1/16	1 17/32	9107900	9107901	9107902
	6 1/8	1 19/32	9107960	9107961	9107962
	6 3/16	1 21/32	9108020	9108021	9108022
	6 1/4	1 23/32	9108080	9108081	9108082
	6 5/16	1 25/32	9108140	9108141	9108142
	6 3/8	1 27/32	9108200	9108201	9108202
	6 7/16	1 29/32	9108260	9108261	9108262
	6 1/2	1 31/32	9108320	9108321	9108322
	6 9/16	2 1/32	2567367	2567368	2567369
	6 5/8	2 3/32	9108380	9108381	9108382
	6 11/16	2 5/32	9108440	9108441	9108442
	6 3/4	2 7/32	9108500	9108501	9108502
	6 13/16	2 9/32	9108560	9108561	9108562
	6 7/8	2 11/32	9108620	9108621	9108622
6 15/16	2 13/32	9108680	9108681	9108682	
<b>7"</b>	7	2 15/32	9108740	9108741	9108742
	7 1/16	2 17/32	9108800	9108801	9108802
	7 1/8	2 19/32	2567382	2567383	2567384

# 400 Series Frenchwood® Gliding Doors (1987 to Present)



*2-Panel, 4-Panel, and Stationary*

## Frames

Extension Jamb / Wood / Head Jamb / White Painted											
											
Wall Depth	Dim A	Stationary			2 Panel			4 Panel			
		29	33	43	50	60	80	100	120	160	
<b>5"</b>	<b>5</b>	<sup>15</sup> / <sub>32</sub>	N/A	N/A	N/A	N/A	N/A	N/A	N/A	N/A	N/A
	<b>5 1/16</b>	<sup>17</sup> / <sub>32</sub>	9106988	9106989	9106990	9106991	9106992	9106993	9106994	9106995	9106996
	<b>5 1/8</b>	<sup>19</sup> / <sub>32</sub>	9107048	9107049	9107050	9107051	9107052	9107053	9107054	9107055	9107056
	<b>5 3/16</b>	<sup>21</sup> / <sub>32</sub>	9107108	9107109	9107110	9107111	9107112	9107113	9107114	9107115	9107116
	<b>5 1/4</b>	<sup>23</sup> / <sub>32</sub>	2567322	2567323	2567324	2567325	2567326	2567327	2567328	2567329	2567330
	<b>5 5/16</b>	<sup>25</sup> / <sub>32</sub>	9107168	9107169	9107170	9107171	9107172	9107173	9107174	9107175	9107176
	<b>5 3/8</b>	<sup>27</sup> / <sub>32</sub>	9107228	9107229	9107230	9107231	9107232	9107233	9107234	9107235	9107236
	<b>5 7/16</b>	<sup>29</sup> / <sub>32</sub>	9107288	9107289	9107290	9107291	9107292	9107293	9107294	9107295	9107296
	<b>5 1/2</b>	<sup>31</sup> / <sub>32</sub>	9107348	9107349	9107350	9107351	9107352	9107353	9107354	9107355	9107356
	<b>5 9/16</b>	<b>1 1/32</b>	9107408	9107409	9107410	9107411	9107412	9107413	9107414	9107415	9107416
	<b>5 5/8</b>	<b>1 3/32</b>	9107468	9107469	9107470	9107471	9107472	9107473	9107474	9107475	9107476
	<b>5 11/16</b>	<b>1 5/32</b>	9107528	9107529	9107530	9107531	9107532	9107533	9107534	9107535	9107536
	<b>5 3/4</b>	<b>1 7/32</b>	9107588	9107589	9107590	9107591	9107592	9107593	9107594	9107595	9107596
	<b>5 13/16</b>	<b>1 9/32</b>	9107648	9107649	9107650	9107651	9107652	9107653	9107654	9107655	9107656
<b>6"</b>	<b>6</b>	<b>1 15/32</b>	9107828	9107829	9107830	9107831	9107832	9107833	9107834	9107835	9107836
	<b>6 1/16</b>	<b>1 17/32</b>	9107888	9107889	9107890	9107891	9107892	9107893	9107894	9107895	9107896
	<b>6 1/8</b>	<b>1 19/32</b>	9107948	9107949	9107950	9107951	9107952	9107953	9107954	9107955	9107956
	<b>6 3/16</b>	<b>1 21/32</b>	9108008	9108009	9108010	9108011	9108012	9108013	9108014	9108015	9108016
	<b>6 1/4</b>	<b>1 23/32</b>	9108068	9108069	9108070	9108071	9108072	9108073	9108074	9108075	9108076
	<b>6 5/16</b>	<b>1 25/32</b>	9108128	9108129	9108130	9108131	9108132	9108133	9108134	9108135	9108136
	<b>6 3/8</b>	<b>1 27/32</b>	9108188	9108189	9108190	9108191	9108192	9108193	9108194	9108195	9108196
	<b>6 7/16</b>	<b>1 29/32</b>	9108248	9108249	9108250	9108251	9108252	9108253	9108254	9108255	9108256
	<b>6 1/2</b>	<b>1 31/32</b>	9108308	9108309	9108310	9108311	9108312	9108313	9108314	9108315	9108316
	<b>6 9/16</b>	<b>2 1/32</b>	2567331	2567332	2567333	2567334	2567335	2567336	2567337	2567338	2567339
	<b>6 5/8</b>	<b>2 3/32</b>	9108368	9108369	9108370	9108371	9108372	9108373	9108374	9108375	9108376
	<b>6 11/16</b>	<b>2 5/32</b>	9108428	9108429	9108430	9108431	9108432	9108433	9108434	9108435	9108436
	<b>6 3/4</b>	<b>2 7/32</b>	9108488	9108489	9108490	9108491	9108492	9108493	9108494	9108495	9108496
	<b>6 13/16</b>	<b>2 9/32</b>	9108548	9108549	9108550	9108551	9108552	9108553	9108554	9108555	9108556
<b>6 7/8</b>	<b>2 11/32</b>	9108608	9108609	9108610	9108611	9108612	9108613	9108614	9108615	9108616	
<b>6 15/16</b>	<b>2 13/32</b>	9108668	9108669	9108670	9108671	9108672	9108673	9108674	9108675	9108676	
<b>7"</b>	<b>7</b>	<b>2 15/32</b>	9108728	9108729	9108730	9108731	9108732	9108733	9108734	9108735	9108736
	<b>7 1/16</b>	<b>2 17/32</b>	9108788	9108789	9108790	9108791	9108792	9108793	9108794	9108795	9108796
	<b>7 1/8</b>	<b>2 19/32</b>	2567340	2567341	2567342	2567343	2567344	2567345	2567346	2567347	2567347

### Frames

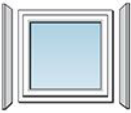
**Extension Jamb / Wood / Side Jamb / White Painted**

					
 WHITE					
Wall Depth	Dim A	68	611	80	
<b>5"</b>	<b>5</b>	$1^{15/32}$			
	<b>5 1/16</b>	$1^{17/32}$	9107009	9107010	9107011
	<b>5 1/8</b>	$1^{19/32}$	9107069	9107070	9107071
	<b>5 3/16</b>	$1^{21/32}$	9107129	9107130	9107131
	<b>5 1/4</b>	$1^{23/32}$	2567361	2567362	2567363
	<b>5 5/16</b>	$1^{25/32}$	9107189	9107190	9107191
	<b>5 3/8</b>	$1^{27/32}$	9107249	9107250	9107251
	<b>5 7/16</b>	$1^{29/32}$	9107309	9107310	9107311
	<b>5 1/2</b>	$1^{31/32}$	9107369	9107370	9107371
	<b>5 9/16</b>	<b>1 1/32</b>	9107429	9107430	9107431
	<b>5 5/8</b>	<b>1 3/32</b>	9107489	9107490	9107491
	<b>5 11/16</b>	<b>1 5/32</b>	9107549	9107550	9107551
	<b>5 3/4</b>	<b>1 7/32</b>	9107609	9107610	9107611
	<b>5 13/16</b>	<b>1 9/32</b>	9107669	9107670	9107671
	<b>5 7/8</b>	<b>1 11/32</b>	9107729	9107730	9107731
<b>5 15/16</b>	<b>1 13/32</b>	9107789	9107790	9107791	
<b>6"</b>	<b>6</b>	<b>1 15/32</b>	9107849	9107850	9107851
	<b>6 1/16</b>	<b>1 17/32</b>	9107909	9107910	9107911
	<b>6 1/8</b>	<b>1 19/32</b>	9107969	9107970	9107971
	<b>6 3/16</b>	<b>1 21/32</b>	9108029	9108030	9108031
	<b>6 1/4</b>	<b>1 23/32</b>	9108089	9108090	9108091
	<b>6 5/16</b>	<b>1 25/32</b>	9108149	9108150	9108151
	<b>6 3/8</b>	<b>1 27/32</b>	9108209	9108210	9108211
	<b>6 7/16</b>	<b>1 29/32</b>	9108269	9108270	9108271
	<b>6 1/2</b>	<b>1 31/32</b>	9108329	9108330	9108331
	<b>6 9/16</b>	<b>2 1/32</b>	2567376	2567377	2567378
	<b>6 5/8</b>	<b>2 3/32</b>	9108389	9108390	9108391
	<b>6 11/16</b>	<b>2 5/32</b>	9108449	9108450	9108451
	<b>6 3/4</b>	<b>2 7/32</b>	9108509	9108510	9108511
	<b>6 13/16</b>	<b>2 9/32</b>	9108569	9108570	9108571
	<b>6 7/8</b>	<b>2 11/32</b>	9108629	9108630	9108631
<b>6 15/16</b>	<b>2 13/32</b>	9108689	9108690	9108691	
<b>7"</b>	<b>7</b>	<b>2 15/32</b>	9108749	9108750	9108751
	<b>7 1/16</b>	<b>2 17/32</b>	9108809	9108810	9108811
	<b>7 1/8</b>	<b>2 19/32</b>	2567391	2567392	2567393

## 400 Series Frenchwood® Gliding Doors (1987 to Present)

*2-Panel, 4-Panel, and Stationary*

### Frames

<b>Extension Jamb - Head Kit / Vinyl White Interior</b>				
	<b>Unit No.</b>	<b>5 1/4" Wall</b>	<b>6 9/16" Wall</b>	<b>7 1/8" Wall</b>
	<b>GD29S</b>	2567294	2567304	2567313
	<b>GD33S</b>	2567295	2567305	2567314
	<b>GD43S</b>	2567296	2567306	2567315
	<b>GD50</b>	2567297	2567307	2567316
	<b>GD60</b>	2567298	2567308	2567317
	<b>GD80</b>	2567299	2567309	2567318
	<b>GD100 4 PAN</b>	2567301	2567310	2567319
	<b>GD120 4 PAN</b>	2567302	2567311	2567320
	<b>GD160 4 PAN</b>	2567303	2567312	2567321

<b>Extension Jamb - Side Kit / Vinyl White Interior (Pair)</b>				
	<b>Unit No.</b>	<b>5 1/4" Wall</b>	<b>6 9/16" Wall</b>	<b>7 1/8" Wall</b>
	<b>GD68</b>	2567358	2567373	2567388
	<b>GD611</b>	2567359	2567374	2567389
	<b>GD80</b>	2567360	2567375	2567390

## Frames

### Sill Ramp Parts

#### Insert Kit - Sill Ramp

**Note:**  
See [Accessory Guide 0004392](#).

<b>Kit Includes:</b> (1) Center ramp (1) Interior ramp (1) Exterior ramp, (1) Track cover (1) Screw pack	Unit No.	Maple	Oak
	<b>FWG50</b>	2572190	2572160
	<b>FWG60</b>	2572191	2572161
	<b>FWG80</b>	2572192	2572162
	<b>FWG100</b>	2572194	2572163
	<b>FWG120</b>	2572195	2572164
	<b>FWG160</b>	2572196	2572165

#### Sill Ramp

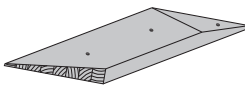
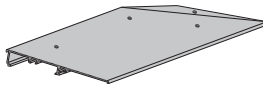
	Interior			Exterior	
					
	Unit No.	Maple	Oak	Unit No.	Order No.
	<b>FWG50</b>	2572197	2572166	<b>FWG50</b>	2572172
	<b>FWG60</b>	2572198	2572167	<b>FWG60</b>	2572173
	<b>FWG80</b>	2572199	2572168	<b>FWG80</b>	2572174
	<b>FWG100</b>	2572202	2572169	<b>FWG100</b>	2572175
	<b>FWG120</b>	2572203	2572170	<b>FWG120</b>	2572176
	<b>FWG160</b>	2572204	2572171	<b>FWG160</b>	2572177

#### Sill Ramp - Center

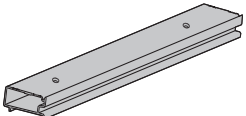
	Unit No.	Order No.
	<b>FWG50</b>	2572178
	<b>FWG60</b>	2572179
	<b>FWG80</b>	2572180
	<b>FWG100</b>	2572181
	<b>FWG120</b>	2572182
	<b>FWG160</b>	2572183

#### Track Cover - Sill Ramp

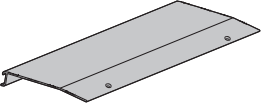
	Unit No.	Order No.
	<b>FWG50</b>	2572184
	<b>FWG60</b>	2572185
	<b>FWG80</b>	2572186
	<b>FWG100</b>	2572187
	<b>FWG120</b>	2572188
	<b>FWG160</b>	2572189



# 400 Series Frenchwood® Gliding Doors (1987 to Present)

*2-Panel, 4-Panel, and Stationary*

## Frames

<b>Fasteners</b>					
Screw Package - Frame / Sidelight					
Unit No.	White	Terratone®	Sandtone	Forest Green	Prefinished Interior White
FWG29/33/43	2573653	2653825	0912802	1262831	2573653
Screw Package - Frame / 2- and 4-Panel					
Unit No.	White	Terratone®	Sandtone	Forest Green	Prefinished Interior White
FWG5068/6116068/611	2573654	2653826	0912804		2573671
FWG5080/6080/8080	2573655	2653827	0912805		2573672
FWG100/12068/611	2573656	2653828	0912806		2573674
FWG16068/160611	2573657	2653829	0912807		2573676
FWG10080/12080	2573663	2653831	0912801		2573675
FWG16080	2573664	2653832	0912803		2573677
Screw Package - Frame / Corrosion Resistant / 2- and 3-Panel					
					Order No.
					1973106
Screw Package - Frame / Corrosion Resistant / Sidelight					
					Order No.
					1973104
Screw Package - Factory Assembled Units					
<b>Package Includes:</b> (13) 2-1/2" x #10 screws (1) Insect screen latch (1) 1" x #8 screw					
		White	Terratone®	Sandtone	Forest Green
		2573491	2653872	0912821	1260162

<b>Installation Kit</b>			
Installation Kit - Door 72 x 83			
Note:			
Used for rectangular openings up to 72" x 83". See <a href="#">Installation Guide 9080775</a> .			
	<b>Kit Includes:</b> (1) Backer Rod - 20 ft. (64) Shims (54) Fasteners - 1 1/2" Roofing nails (1) Self-Adhering Flashing Tape - 22 ft. (1) Flexible Sill Flashing Tape - 7 ft. (1) Insulating Foam - 12 oz. can (3) Sealant - 10.1 oz. tube Installation Guide	<b>Product Lines</b> Multiple	<b>Order No.</b> 9080774

## Joining Components

### Fiberglass Joining Exploded View

**Note:**

See (1-Way, 1-Way Assembly in Opening and 2-Way) [Joining Guide 9180250](#).

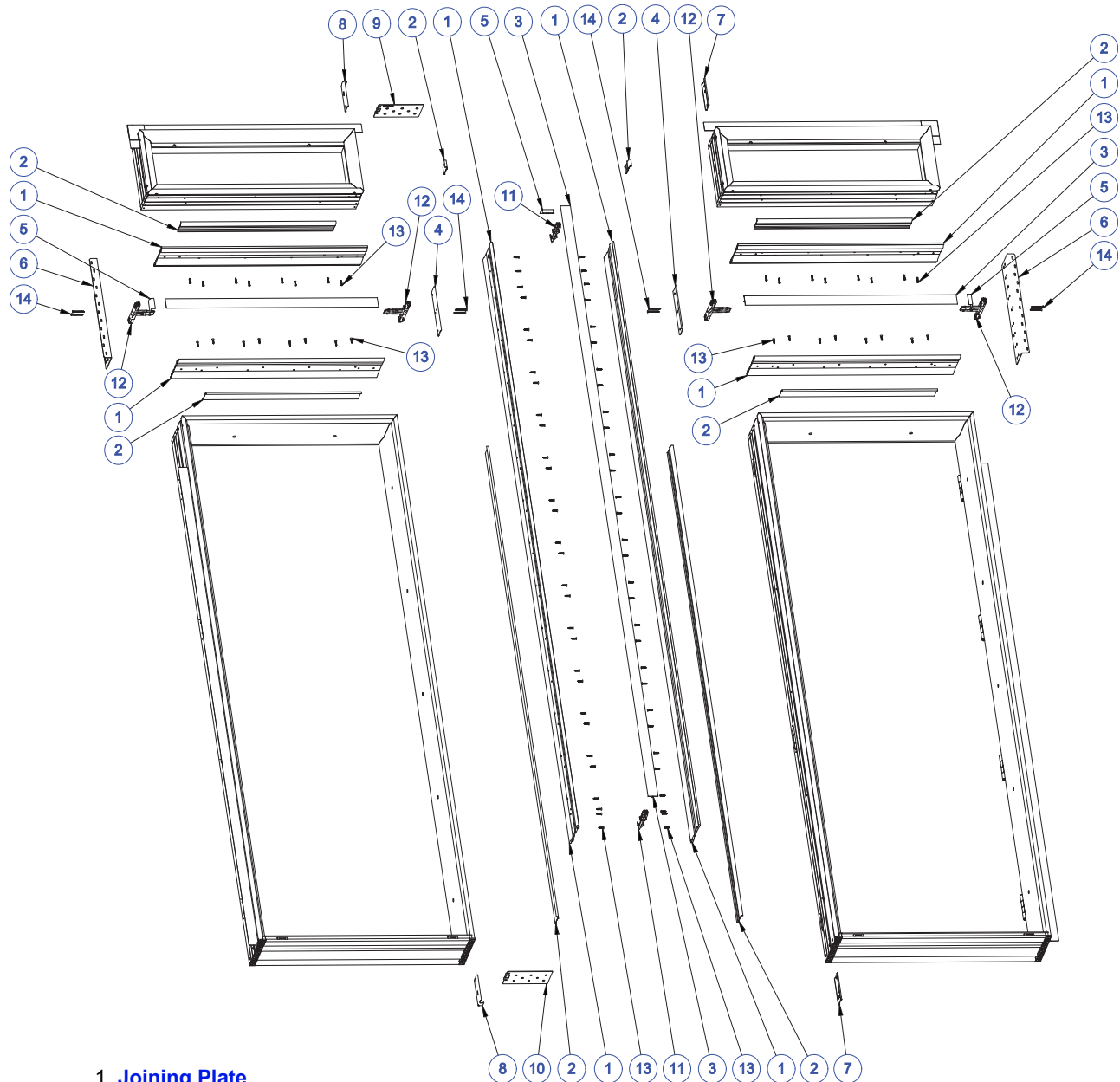

- 1. [Joining Plate](#)
- 2. [Joining Plate Alignment Spacer](#)
- 3. [Exterior Trim Strip](#)
- 4. [Intersection Bracket](#)
- 5. [End Cap](#)
- 6. [Gusset Plate](#)

- 7. [Fixed Bracket](#)
- 8. [Slide Bracket](#)
- 9. [Flat Side Gusset \(A\)](#)
- 10. [Flat Side Gusset \(B\)](#)
- 11. [End Plug](#)
- 12. [Locking/Sealing Plug](#)
- 13. [7/8" Screw](#)
- 14. [2" Screw](#)

# 400 Series Frenchwood® Gliding Doors (1987 to Present)

2-Panel, 4-Panel, and Stationary

## Joining Components

### Fiberglass Joining Kits

#### Joining Kits - FGL / 4 9/16"

**Kit Includes:**  
 (2) Joining Plate  
 (2) Alignment Spacer  
 (1) Exterior Trim Strip (length dimension shown)  
 (2) Flange Gusset 18"  
 (1) Hardware Kit  
 (1) Sealant

Color	Size									
	31	33	60	64	68	611	80	100	104	120
	Length									
	35 <sup>27</sup> / <sub>32</sub>	37 <sup>19</sup> / <sub>32</sub>	71	74 <sup>3</sup> / <sub>4</sub>	79 <sup>1</sup> / <sub>4</sub>	82 <sup>1</sup> / <sub>8</sub>	95 <sup>1</sup> / <sub>4</sub>	119 <sup>1</sup> / <sub>4</sub>	123 <sup>1</sup> / <sub>4</sub>	143 <sup>3</sup> / <sub>4</sub>
White	9179836	9179837	9179838	9179839	9179840	9179841	9179842	9179843	9179844	9179845
Terratone®	9179826	9179827	9179828	9179829	9179830	9179831	9179832	9179833	9179834	9179835
Sandtone	9179816	9179817	9179818	9179819	9179820	9179821	9179822	9179823	9179824	9179825
Forest Green	9179786	9179787	9179788	9179789	9179790	9179791	9179792	9179793	9179794	9179795
Canvas	9179746	9179747	9179748	9179749	9179750	9179751	9179752	9179753	9179754	9179755
Black	9179736	9179737	9179738	9179739	9179740	9179741	9179742	9179743	9179744	9179745
Dark Bronze	9179766	9179767	9179768	9179769	9179770	9179771	9179772	9179773	9179774	9179775

#### Joining Kits - FGL / 6 9/16"

**Kit Includes:**  
 (2) Joining Plate  
 (2) Alignment Spacer  
 (1) Exterior Trim Strip (length dimension shown)  
 (2) Flange Gusset 18"  
 (1) Hardware Kit  
 (1) Sealant

	Color	Size	
		104	140
		Length	
		123 <sup>1</sup> / <sub>4</sub>	167 <sup>3</sup> / <sub>4</sub>
White		9179866	9179867
Terratone®		9179864	9179865
Sandtone		9179862	9179863
Forest Green		9179856	9179857
Canvas		9179848	9179849
Black		9179846	9179847
Dark Bronze		9179854	9179855

## Joining Components

<b>Fiberglass Joining Hardware Kits</b>		
<b>Hardware Kit - FGL Joining</b>		
<b>Kit Includes:</b> (1) Intersection Bracket (2) Fixed Bracket (2) Slide Bracket (1) Flat Side Gusset Type A (1) Flat Side Gusset Type B (2) Locking/Sealing Plug (2) End Plug (2) End Cap (18) Screw 10-16 x 2 (52) Screw 10-12 x 7/8 (1) Gasket	<b>Color</b>	<b>Order No.</b>
	White	9180115
	Terratone®	9180114
	Sandtone	9180113
	Forest Green	9180110
	Canvas	9180107
	Prairie Grass	9180111
	Cocoa Bean	9180106
	Dove Gray	9180108
	Red Rock	9180112
	Black	9179999
	Dark Bronze	9180109

# 400 Series Frenchwood® Gliding Doors (1987 to Present)

2-Panel, 4-Panel, and Stationary

## Joining Components

### Fiberglass Joining Kit Components

#### Trim Strip - FGL

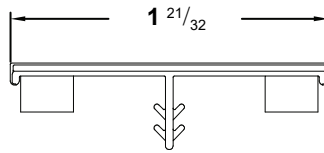

Color	Size										
	31	33	60	64	68	611	80	100	104	120	120
	Length										
	35 <sup>27</sup> / <sub>32</sub>	37 <sup>27</sup> / <sub>32</sub>	71	74 <sup>3</sup> / <sub>4</sub>	79 <sup>1</sup> / <sub>4</sub>	82 <sup>1</sup> / <sub>8</sub>	94 <sup>1</sup> / <sub>4</sub>	119 <sup>1</sup> / <sub>4</sub>	123 <sup>1</sup> / <sub>4</sub>	143 <sup>3</sup> / <sub>4</sub>	167 <sup>3</sup> / <sub>4</sub>
White	9179978	9179979	9179980	9179981	9180159	9180160	9180161	9180162	9179982	9179983	9179984
Terratone®	9179971	9179972	9179973	9179974	9180155	9180156	9180157	9180158	9179975	9179976	9179977
Sandtone	9179964	9179965	9179966	9179967	9180151	9180152	9180153	9180154	9179968	9179969	9179970
Forest Green	9179935	9179936	9179937	9179938	9180147	9180148	9180149	9180150	9179939	9179940	9179941
Canvas	9179899	9179900	9179901	9179902	9180139	9180140	9180141	9180142	9179903	9179904	9179905
Prairie Grass	9179942	9179943	9179944	9179945	9179946	9179947	9179948	9179949	9179950	9179951	9179952
Cocoa Bean	9179906	9179907	9179908	9179909	9179910	9179911	9179912	9179913	9179914	9179915	9179916
Dove Gray	9179917	9179918	9179919	9179920	9179921	9179922	9179923	9179924	9179925	9179926	9179927
Red Rock	9179953	9179954	9179955	9179956	9179957	9179958	9179959	9179960	9179961	9179962	9179963
Black	9179891	9179892	9179893	9179894	9180136	9180137	9180138	9179895	9179896	9179897	9179898
Dark Bronze	9179928	9179929	9179930	9179931	9180143	9180144	9180145	9180146	9179932	9179933	9179934

#### End Cap - FGL

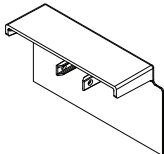

Color	Order No.
White	9043111
Terratone®	9043119
Sandtone	9043110
Forest Green	9043118
Canvas	9043112
Prairie Grass	9043117
Cocoa Bean	9043116
Dove Gray	9043113
Red Rock	9043114
Black	9043115
Dark Bronze	9043120

## Joining Components

Inside Casing - 2 1/8"										
Finish	96"			120"						
	Pine	Maple	Oak	Pine	Maple	Oak	Cherry	Mahogany	Douglas Fir	Alder
Unfinished	9067316	9064335	9064417	9068749	9068751	9068750	9140911	9140912	9140910	9140913
White	9013179	9055406	9040761	9013180	9040762	9055403	-	-	-	-
Clear Coat	9013183	9013187	9013185	9013184	9013188	9013186	-	-	-	-
Cinnamon	9013207	9013211	9013209	9013208	9013212	9013210	-	-	-	-
Mocha	9013195	9013199	9013197	9013196	9013200	9013198	-	-	-	-
Primed	9013181	9055407	9040763	9013182	9040764	9055404	-	-	-	-
Honey	9013201	9013205	9013203	9013202	9013206	9013204	-	-	-	-
Russet	9013189	9013193	9013191	9013190	9013194	9013192	-	-	-	-
Espresso	9013215	9013219	9013217	9013216	9013220	9013218	-	-	-	-
Birch Bark (Bright White)	9013213	9055408	9040765	9013214	9040766	9055405	-	-	-	-

Joining Plate - FGL					
<b>Note:</b> Need two per mull. Cut to fit joining plates 1 1/2" shorter than the overall mulled length or width.					
 4 9/16	 6 9/16	Depth	Size	Length	Order No.
		<div style="display: flex; justify-content: space-around;"> <div style="text-align: center;"> <p>4 9/16</p> </div> <div style="text-align: center;"> <p>6 9/16</p> </div> </div>		4 9/16	31
33	36 19/32				9179869
60	69 3/4				9179870
64	73 1/2				9179871
68	78				9179872
611	80 7/8				9179873
80	94				9179874
100	118				9179875
104	122				9179876
120	142 1/2				9179877
<div style="display: flex; justify-content: space-around;"> <div style="text-align: center;"> <p>4 9/16</p> </div> <div style="text-align: center;"> <p>6 9/16</p> </div> </div>		6 9/16	100	118	9179878
			140	166 1/2	9179879

# 400 Series Frenchwood® Gliding Doors (1987 to Present)

2-Panel, 4-Panel, and Stationary

## Joining Components

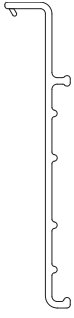
Joining Plate Alignment Spacer - FGL				
<b>Note:</b> Need one per unit jamb that is to be joined. Required length: Join dimension - 1 1/2"				
		Size	Length	Order No.
		31	26 3/32	9179880
		33	28 3/32	9179881
		60	61 1/4	9179882
		64	65	9179883
		68	69 1/2	9179884
		611	72 3/8	9179885
		80	85 1/2	9179886
		100	109 1/2	9179887
		104	113 1/2	9179888
		120	134	9179889
		140	158	9179890

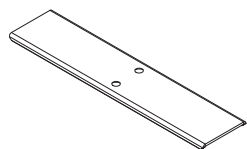
Intersection Bracket - FGL		
		Order No.
		9152243

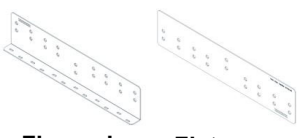
Gusset Plate - FGL / 18"			
<b>Note:</b> Need two per join. Required length: Join dimension - 1 1/2"			
 <b>Flanged</b> <b>Flat</b>		Type	Order No.
		Flat	9179994
		Flanged	9179993

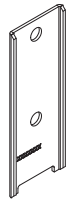
Fixed Bracket - FGL		
		Order No.
		9179997

## Joining Components

Slide Bracket - FGL		
		<b>Order No.</b>
		9179998

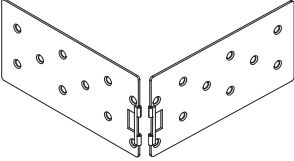
Flat Slide Gusset - FGL			
 Type A      Type B		<b>Type</b>	<b>Order No.</b>
		A	9179995
		B	9179996

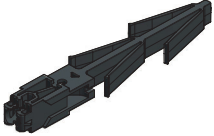
End Plug - FGL		
		<b>Order No.</b>
		9179992

Locking/Sealing Plug - FGL		
		<b>Order No.</b>
		9177451

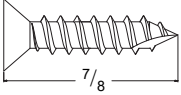
Screw Package - 7/8" FGL Screw			
<b>Package Includes:</b>			
(52) Fasteners 10-16 x 7/8" PH FL Type 17			
 7/8		<b>Qty</b>	<b>Order No.</b>
		52	9159384

Screw Package - 2" FGL Screw			
		<b>Qty</b>	<b>Order No.</b>
		18	9017654



# 400 Series Frenchwood® Gliding Doors (1987 to Present)

2-Panel, 4-Panel, and Stationary

## Joining Components

### Narrow Mull Joining Kits

**Note:**

Interior Trim Strip # 2 is not included with Frenchwood Gliding Door Kit. See [Joining Guide 0000665](#).

1. Exterior Trim Strip, Notched and Beveled at Sill
2. Interior Trim Strip
3. Screws, #10 x 1 5/8" and #10 x 1"
4. Mullion Head Flashing

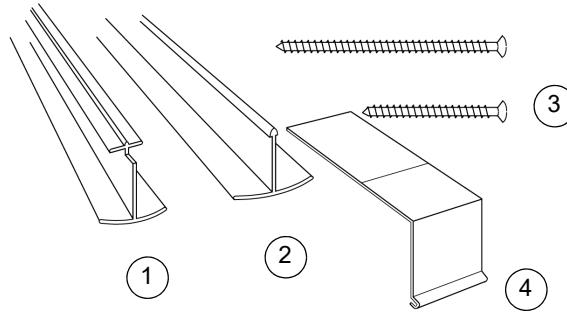

**Frenchwood® Gliding Narrow Mullion**

### Joining Kit - Narrow Mullion

Unit No.	Length	White	Terratone®	Sandtone	Forest Green	Canvas	Dark Bronze
FWG68	78 7/32	2510114	2620004	0911206	1262821	9033900	9071939
FWG611	81 3/32	2510215	2620109	0911207	1262822	9033904	9071940
FWG80	94 7/32	2510116	2620010	0911208	1262823	9033901	9071941

### Trim Strip - Outside Vinyl Ref. No. 1

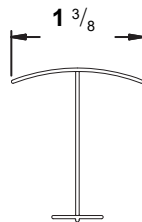

Unit No.	Length	White	Terratone®	Sandtone	Forest Green	Canvas	Dark Bronze
FWG68	78 7/32	1970927	2640740	0903747	1262845	9033570	9071946
FWG611	81 3/32	1970928	2640741	0903748	1262846	9033571	9071947
FWG80	94 7/32	2510220	2652907	0912419	1262847	9033576	9071948

### Mull Casing - Inside - Pine - 2 5/8"

**Note:**

Interior casing does not ship with FWG joining kit.

Length	Pine
96"	1386812
144"	1386814

### Head Flashing Ref. No. 4

Unit No.	Length	White	Terra-tone®	Sandtone	Forest Green	Dark Bronze
All Units	2 1/2	1997264	2640728	0903522	1262726	9071945

## Joining Components

Screw Ref. No. 3					
	Description	White	Terratone®	Sandtone	Gray
		10-16 x 1 5/8" TYP AB	3620649	3620646	3620648

Screw Ref. No. 3		
	Description	Order No.
		10-12 x 1 TYP 17

# 400 Series Frenchwood® Gliding Doors (1987 to Present)

2-Panel, 4-Panel, and Stationary

## Joining Components

### Vintage LVL Joining Kit Components

**Note:**

Laminated Veneered Lumber (LVL) joining system was replaced by Easy Connect Joining System (ECJS) in July 2019. Some kits and component parts are unavailable.

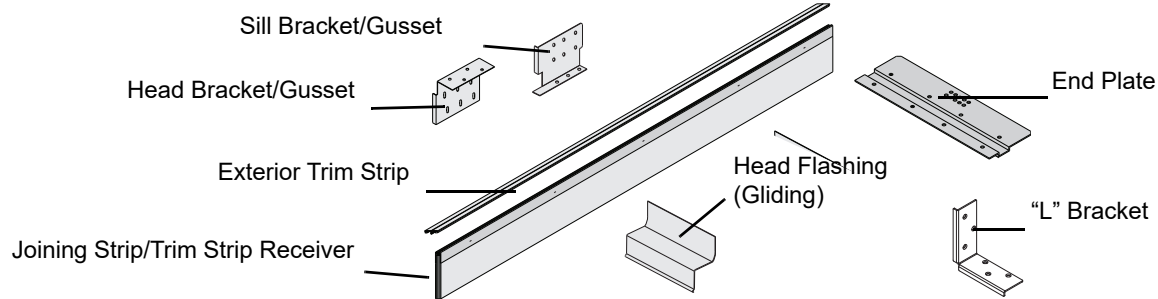

### Trim Strip - LVL / Exterior / 3/4"

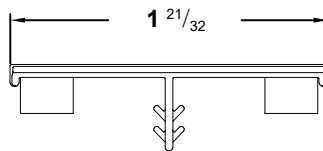

Unit No.	Length	White	Terratone®	Sandtone	Forest Green	Canvas	Dark Bronze	Black
68	79 1/4	2573492	2640743	0903750	1262848	9033578	9020914	9006503
611	82 1/8	2573496	2640744	0903751	1262849	9033579	9020915	9006508
80	95 1/4	2573488	2640745	0903752	1262850	9033577	9020916	9006513
10 ft	117 13/16	2510101	2640746	0903753	1262851	9033574	9020917	9208860

### Flashing - LVL / Exterior Support Mullion / 4 5/8"

Color	Order No.
White	1997266
Terratone®	2640729
Sandtone	0903524
Forest Green	1262727
Canvas	9033583
Dark Bronze	9020909

## Joining Components

Inside Casing - LVL Reinforced / 3/4" and Narrow Mullion / 2 3/8"				
	<b>Note:</b> Inside casing is not part of LVL joining kit.	Length	Finish	Order No.
		96"	White (Vinyl)	1916008
			Sandtone	9069014
			Terratone®	9069015
			Forest Green	9069016
			Pine	1916007
			Maple	1916010
			Oak	1916009
		120"	White (Vinyl)	1916002
			Pine	1916001
			Maple	1916004
			Oak	1916003

# 400 Series Frenchwood® Gliding Doors (1987 to Present)

2-Panel, 4-Panel, and Stationary

## Joining Components

### Support Mull Joining Kits

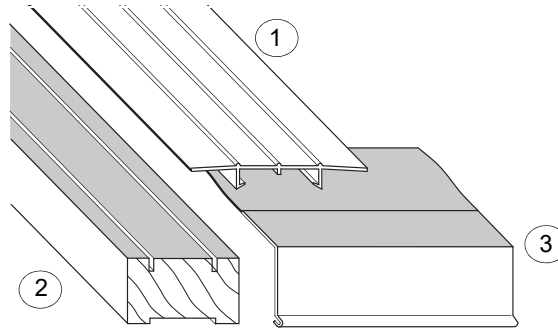

1. Outside Vinyl Trim Strip
2. Filler
3. Head Flashing

**Frenchwood® Gliding Support Mullion**

### Joining Kit - Support Mullion

**Kit includes:**

Outside vinyl trim strip, filler, flashing and fasteners. Colors not shown may have been available as an SPR.

Unit No.	Length	White	Terratone®	Sandtone	Forest Green	Canvas	Dark Bronze
FWG68	79 <sup>7</sup> / <sub>16</sub>	2510212	2620103	0900406	1262824	9033902	9071942
FWG611	82 <sup>5</sup> / <sub>16</sub>	1916512	2460204	0900408	1262829	9033898	9071943
FWG80	95 <sup>7</sup> / <sub>16</sub>	2510214	2620108	0911210	1262825	9033903	9071944

### Trim Strip - Support Mullion / Outside Vinyl Ref. No. 1

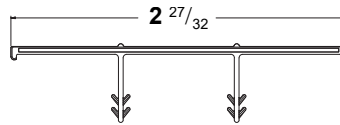

Unit No.	Length	White	Terratone®	Sandtone	Forest Green	Canvas	Dark Bronze
FWG68	79 <sup>7</sup> / <sub>16</sub>	1970929	2668706	0924706	1267804	N/A	N/A
FWG611	82 <sup>5</sup> / <sub>16</sub>	1970930	2668707	0924707	1267805	N/A	N/A
FWG80	95 <sup>7</sup> / <sub>16</sub>	2579708	2668708	0924708	1267806	9033572	9020912

### Filler - Support Mullion Ref. No. 2

Unit No.	Length	Order No.
FWG68	79 <sup>7</sup> / <sub>16</sub>	2579714
FWG611	82 <sup>5</sup> / <sub>16</sub>	2579715
FWG80	95 <sup>7</sup> / <sub>16</sub>	2579716

### Head Flashing - Support Mullion Ref. No. 3

Size							
4 <sup>3</sup> / <sub>8</sub>				6			
Color	Order No.	Color	Order No.	Color	Order No.	Color	Order No.
White	1997266	Dove Gray	9006527	White	2573484	Dove Gray	9006522
Terratone®	2640729	Red Rock	9006528	Terratone®	2640727	Red Rock	9006523
Sandtone	0903524	Black	9006529	Sandtone	0903517	Black	9006524
Forest Green	-	Cocoa Bean	9006530	Forest Green	1252809	Cocoa Bean	9006525
Canvas	9033583	Prairie Grass	9006531	Canvas	3282404	Prairie Grass	9006526
Dark Bronze	9020909			Dark Bronze	9020908		

## Joining Components

### Universal Drip Cap - Continuous

**Note:**

Use on side-by-side or vertical joins mullled at the factory or distributor. Consists of 24 gauge aluminum material.

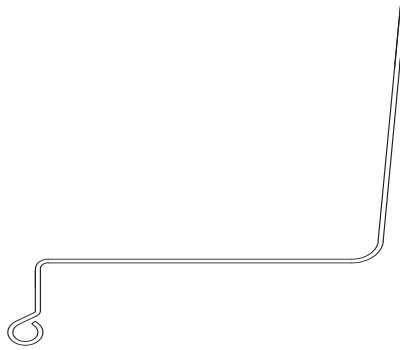

	72"			120"			151 1/2"	
	Package Quantity			Package Quantity			Package Quantity	
	1	10	40	1	10	40	1	10
<b>White</b>	2222525	2222526	2222527	2222546	2222547	2222548	2222555	2222556
<b>Terratone®</b>	2222528	2222529	N/A	2222549	2222550	N/A	2222557	2222558
<b>Sandtone</b>	2222530	2222531	N/A	2222551	2222552	N/A	2222559	2222560
<b>Forest Green</b>	2222532	2222533	N/A	2222553	2222554	N/A	2222561	2222562
<b>Canvas</b>	9003116	9003117	N/A	9003126	9003127	N/A	9003130	9003131

## Art Glass Components

### Trim Stops - Art Glass

**Note:**

For stationary sidelights only. Art glass can not be installed on operating panels. Information about ordering replacement art glass panels can be found in the Andersen® Art Glass section of the catalog.

#### Trim Stop - Art Glass / Head and Sill

		<b>Unit No.</b>	<b>Length</b>	<b>Order No.</b>
		<b>AGFWG26</b>	20 <sup>9</sup> / <sub>16</sub>	2370181
		<b>AGFWG30</b>	26 <sup>9</sup> / <sub>16</sub>	2370182
		<b>AGFWG40</b>	38 <sup>9</sup> / <sub>16</sub>	2370183

#### Trim Stop - Art Glass / Side

		<b>Unit No.</b>	<b>Length</b>	<b>Order No.</b>
		<b>AGFWG68</b>	65 <sup>1</sup> / <sub>8</sub>	2370186
		<b>AGFWG80</b>	67 <sup>15</sup> / <sub>16</sub>	2370187
		<b>AGFWG611</b>	81 <sup>1</sup> / <sub>8</sub>	2370188

### Art Glass Hardware

#### Bracket Package with Shims and Screws - Art Glass / Top and Bottom

	<b>Unit No.</b>	<b>Order No.</b>
	AG FWD	2370019

#### Bracket with Screws - Art Glass / Top

	<b>Order No.</b>
	2370024

#### Screw - Art Glass

	<b>Description</b>	<b>Order No.</b>
	Brass oval head package, AG 1x5 STD	2370026

#### Screw - Art Glass / Sill Stop Package

	<b>Description</b>	<b>Order No.</b>
	AG 5X9/16 FWD/PSC	2370029

## 400 Series Frenchwood® Gliding Doors (1987 to Present)

---

### Notes

---



## 400 Series Frenchwood® Gliding Doors (1987 to Present)

---

### Stormwatch® Protection (Coastal Product)

**Note:**

Andersen® products with Stormwatch protection are designed for use in coastal areas. They feature design pressure upgrades, glass options, and structural enhancements. Individual IR frames and side jambs are no longer available. Available parts in this section have moved to the Service Replacement section on [page 25](#).

Parts shared with standard doors are listed in the standard product pages of the section.

## Notes

---

# 400 Series Frenchwood® Gliding Doors (1987 to Present)

## Service Replacement

### Service Replacement Only Parts

#### Service Replacement Only Parts

**Note:**

This section is specifically designed for parts that should only be ordered if a Field Service Manager/Service Provider has requested them to be ordered or if the customer agrees to also pay for a non-warranty repair/replace service job (subject to availability) for these parts to be installed. We do not recommend anyone other than a trained AW employee or Service Provider install these parts due to the complexity of installation, modifications required for installation and/or requirement of special tools.

#### Exterior Grilles - High Definition (HDN)

**Note:**

Permanently applied grilles can only be ordered by Andersen Territory Service Representatives, Andersen Service Dealers and Providers.

##### Exterior Grilles - Taped / Chamfer A / 96"

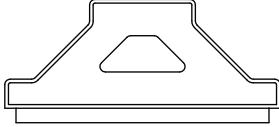
	<b>Width/ Length</b>	<b>2 1/4"</b>	<b>1 1/8"</b>	<b>7/8"</b>	<b>3/4"</b>
		96"	96"	96"	96"
	<b>White</b>	1284332	1284331	1284330	1284329
	<b>Terratone</b>	9011974	9011973	9011972	9011971
	<b>Sandtone</b>	1284328	1284327	1284326	1284325
	<b>Forest Green</b>	9011970	9011969	9011968	9011967
	<b>Canvas</b>	1284360	1284359	1284358	1284357

##### Exterior Grilles - Taped / Chamfer A / 144"

	<b>Width/ Length</b>	<b>2 1/4"</b>	<b>1 1/8"</b>	<b>7/8"</b>	<b>3/4"</b>
		144"	144"	144"	144"
	<b>White</b>	9033552	9033551	9033550	9033549
	<b>Terratone</b>	9033560	9033559	9033558	9133557
	<b>Sandtone</b>	9033548	9033547	9033546	9033545
	<b>Forest Green</b>	9133556	9033555	9033554	9033553
	<b>Canvas</b>	9122004	9122003	9122002	9122001

## Service Replacement Only Parts

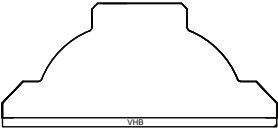
Exterior Grille - HDN / Lineal / PVC									
	Width/ Length	2 1/4"		1 1/8"		7/8"		3/4"	
		60"	84"	60"	84"	60"	84"	60"	84"
White		NA		2322038	2322039	2322034	2322035	2322030	2322031
Terratone		NA		N/A	N/A	N/A	N/A	N/A	N/A
Sandtone		NA		N/A	N/A	N/A	N/A	N/A	N/A

Exterior Grille / Colonial				
		Size	Sandtone	
			Center	Outside
			7/8"	
		68	0913008	0913010
		611	0913012	0913011
		80	0913018	0913020

# 400 Series Frenchwood® Gliding Doors (1987 to Present)

Service Replacement

## Service Replacement Only Parts



### Interior Grilles - High Definition (HDN)

#### Interior Grilles - Taped / Chamfer A

**Note:**

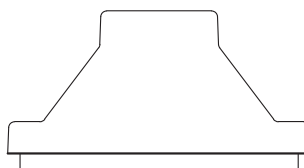
Permanently applied grilles can only be ordered by Andersen Territory Service Representatives, Andersen Service Dealers and Providers. Contact your local [Andersen Service Provider](#). ❌



	Length	Pine			
		3/4"	7/8"	1 1/8"	2 1/4"
 <p>PINE</p>	22"	2321131	2321136	2321141	2321146
	34"	2321132	2321137	2321142	2321147
	44"	2321133	2321138	2321143	2321148
	60"	2321134	2321139	2321144	2321149
	84"	2321135	2321140	2321145	2321150
	Length	Oak			
		3/4"	7/8"	1 1/8"	2 1/4"
 <p>OAK</p>	22"	2321111	2321116	2321121	2321126
	34"	2321112	2321117	2321122	2321127
	44"	2321113	2321118	2321123	2321128
	60"	2321114	2321119	2321124	2321129
	84"	2321115	2321120	2321125	2321130
	Length	Maple			
		3/4"	7/8"	1 1/8"	2 1/4"
 <p>MAPLE</p>	22"	2321010	2321015	2321020	2321025
	34"	2321011	2321016	2321021	2321026
	44"	2321012	2321017	2321022	2321027
	60"	2321013	2321018	2321023	2321028
	84"	2321014	2321019	2321024	2321029