

What's in This Section

Standard Windows	Page 3
Parts Illustration	3
Parts Illustration	3
Colors - Exterior	4
Colors/Species/Finishes - Interior	5
Unit Sizes	6
Standard and Custom Window Sizes	6
E Series Product Label	6
Unit Size Chart - Standard Windows	7
Sash Size Table - Transom	8
Sash Size Table - Picture	10
Product History	12
Product History	12
Sash	13
Sash Graphic - Transom	13
Sash Graphic - Picture	14
Sash Options	15
Weatherstrip	16
Sash Components / Miscellaneous	16
Glass	17
Glass	17
Glass Stops	18
Glass Parts	19
Grilles	20
Grilles	20
Grille Options	21
Interior Grille Parts	22
Frames	23
Frame Graphic - Standard Windows	23
Frame	24
Stops	25
Hardware and Frame Parts	26

E-Series Double-Hung Picture & Transom Windows (2007 to Present)

Standard Windows

Parts Illustration

Parts Illustration

The illustration shows a double-hung window unit with two sashes. The top sash is partially open, revealing the internal mechanism. The bottom sash is closed. The window is set within a frame. The parts are labeled as follows:

- 1. Sash
- 2. Stop (Head Support, Side Support)
- 3. Weatherstrip
- 4. Sash Wedge
- 5. Glass
- 6. Stop (Interior Trim)
- 7. Stop (Glass)
- 8. Filler Block

E-Series Double-Hung Picture Window Unit Parts

Parts Illustration

Colors - Exterior

Note:
(*) Anodized Finishes

				Colony White	White	Abalone	Balsa White
			Canvas	Maple Syrup	Harvest Gold	Prairie Grass	
Flagstone	Sandtone	Pebble Tan	Carmel	Terratone	Hot Chocolate	Bourbon	
Acorn	Coffee Bean	Cocoa Bean	Sierra Bronze	Dark Bronze	Clay Canyon	Red Rock	
Cardinal	Bing Cherry	Fire Engine Red	Cinnamon Toast	Olive	Sage	Billiard Green	
Moss	Forest Green	Mallard Green	Spearmint	Aquamarine	Patina	Sky Blue	
Country Blue	Blue Denim	Watercolor Blue	Caribbean Blue	Slate	Moody Blue	Stormy Blue	
Dove Gray	Harbor Mist	Yorktown Pewter	Smokey Gray	Mystic Gray	Dark Ash	Black	
Light Bronze*	Champagne*	Clear Anodized*	Black	Dark Bronze*	Copper*	Medium Bronze*	

E-Series Double-Hung Picture & Transom Windows (2007 to Present)

Standard Windows

Parts Illustration

Colors/Species/Finishes - Interior

Species Interior Options



Pine



Mixed Grain
Douglas Fir



Oak



Maple

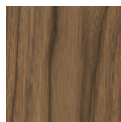

Walnut



Alder



Hickory



Mahogany



Vertical Grain
Douglas Fir



Cherry



White Oak

Stained Interior Options



Clear Coat



Wheat



Autumn Oak



Golden Hickory



Honey

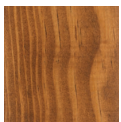

Cinnamon

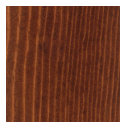

Russet



Mocha

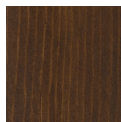

Espresso

Painted Interior Options

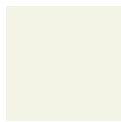

White

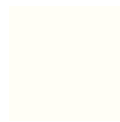

Birch Bark



Primed



Canvas



Sandtone



Terratone



Forest Green



Dark Bronze



Dove Gray



Prairie Grass



Red Rock



Cocoa Bean



Black



Anodized Silver ¹

Unit Sizes

Standard and Custom Window Sizes

Note:

E-Series Double-Hung Picture Windows are available in standard sizes (see standard size charts, [page 7](#)). Replacement parts for some standard windows can be ordered using the numbers listed in this catalog. Many replacement parts for standard windows are made to order. These items are ordered using the Product ID found on the identification label and a description of the part needed. See [Service Guide 9051877](#).

E-Series Double-Hung Picture Windows are also available in custom sizes in 1/8" increments between the smallest and the largest standard sizes. Most replacement parts for custom-sized windows are made to order and can be ordered with the Product ID found on the identification label and a description of the part needed. See [Service Guide 9051877](#).

E Series Product Label

Note:

Every E-Series Double-Hung Picture Window will have an identification label **or** glass etching containing a unique Product ID. The Product ID on E-Series Double-Hung Picture Windows will be located at the top of the window frame or etched into the glass. See [Service Guide 9051877](#). The Product ID may be up to 14 digits long (excluding hyphens), depending on the age of the unit. Replacement parts will also get their own unique Product ID. When ordering replacement parts, providing the Product ID ensures that replacement parts match the specifications.



Andersen
 MAY HAVE FORN...-0200218513902 H/N/EDM ICI12511A-ED...
 E-Series Double-Hung
 Class LC-P630 Size tested 40.0x84.0in*
 Size: 23.8750x 80.2500 MFC AND-N-171-01525-20201
 Glazing: Exterior 2.0mm ann., Interior 2.0mm ann.
 WDMA Serial Number: MFWH220-033020-0002 PERM116

E-Series Double-Hung Picture & Transom Windows (2007 to Present)

Standard Windows

Unit Sizes

Unit Size Chart - Standard Windows

Note:

Unit Dimension refers to overall outside-to-outside frame.

Double-Hung Picture Window Sizes

	3' 0 1/2"	3' 2 1/2"	3' 4 1/2"	4' 0 1/2"	5' 0 1/2"
	3' 0"	3' 2"	3' 4"	4' 0"	5' 0"
4' 0 1/2"					
	DHP3040	DHP3240	DHP3440	DHP4040	DHP5040
4' 6 1/2"					
	DHP3046	DHP3246	DHP3446	DHP4046	DHP5046
5' 0 1/2"					
	DHP3050	DHP3250	DHP3450	DHP4050	DHP5050
5' 1 1/2"					
	DHP3051	DHP3251	DHP3451	DHP4051	DHP5051
5' 6 1/2"					
	DHP3056	DHP3256	DHP3456	DHP4056	DHP5056
6' 0 1/2"					
	DHP3060	DHP3260	DHP3460	DHP4060	DHP5060
6' 6 1/2"					
	DHP3066	DHP3266	DHP3466	DHP4066	DHP5066

NOTES

If glass is positioned within 18" of the finished floor, safety/tempered glass may be required. Local codes may differ. Verify tempered glass requirements with your local building code official.

Use structural joining material when necessary or required by code.

The light patterns illustrated apply to rectangular removable interior wood grilles, Full Divided Light, Simulated Divided Light, Decorelle 100, 150 and 400 and Finelight™ Grilles-Between-the-Glass. All removable interior wood grilles will be installed in the units unless otherwise specified.

For a metric conversion in millimeters, multiply dimensions in inches by 25.4.

FORMULA FOR COMBINATION WINDOWS

The overall frame dimension (both width and height) is equal to the sum of the individual unit frame dimensions plus joining material dimension(s).

The overall rough opening (both width and height) is equal to the overall frame dimensions plus 1/4" on all sides.

Double-Hung Transom Window Sizes

	1' 8 1/2"	2' 0 1/2"	2' 4 1/2"	2' 6 1/2"	2' 8 1/2"	3' 0 1/2"	3' 2 1/2"	3' 4 1/2"	3' 8 1/2"	4' 0 1/2"	5' 0 1/2"
	1' 8"	2' 0"	2' 4"	2' 6"	2' 8"	3' 0"	3' 2"	3' 4"	3' 8"	4' 0"	5' 0"
1' 2"											
	DHT1812	DHT2012	DHT2412	DHT2612	DHT2812	DHT3012	DHT3212	DHT3412	DHT3812	DHT4012	DHT5012
1' 4"											
	DHT1814	DHT2014	DHT2414	DHT2614	DHT2814	DHT3014	DHT3214	DHT3414	DHT3814	DHT4014	DHT5014
1' 6"											
	DHT1816	DHT2016	DHT2416	DHT2616	DHT2816	DHT3016	DHT3216	DHT3416	DHT3816	DHT4016	DHT5016
1' 8"											
	DHT1818	DHT2018	DHT2418	DHT2618	DHT2818	DHT3018	DHT3218	DHT3418	DHT3818	DHT4018	DHT5018
2' 0"											
	DHT1820	DHT2020	DHT2420	DHT2620	DHT2820	DHT3020	DHT3220	DHT3420	DHT3820	DHT4020	DHT5020

FOR WINDOWS OVER 30 SQUARE FEET OR RATED HIGHER THAN PG50, ONE OF THESE THREE INSTALLATION METHODS IS REQUIRED:
 A) THROUGH THE JAMB B) ALUMINUM NAILING FLANGE OR C) INSTALLATION CLIPS.
 ADDITIONAL CUSTOM SIZES ARE AVAILABLE. CONTACT YOUR LOCAL SUPPLIER FOR MORE INFORMATION. DRAWINGS ARE NOT TO SCALE.



E-Series Double-Hung Picture & Transom Unit Sizes

Unit Sizes

Sash Size Table - Transom

Note:



See FS00304 for additional information.

Sash Size Table - Transom				
		Overall Sash w x h	Overall Glass w x h	Unobstructed Glass w x h
				
Unit No.		Sash	Glass	
18	TDHT1812	16 ³ / ₁₆ x 11 ¹ / ₁₆	13 ¹⁵ / ₁₆ x 8 ¹³ / ₁₆	12 ¹⁵ / ₁₆ x 7 ¹³ / ₁₆
	TDHT1814	16 ³ / ₁₆ x 13 ¹ / ₁₆	13 ¹⁵ / ₁₆ x 10 ¹³ / ₁₆	12 ¹⁵ / ₁₆ x 9 ¹³ / ₁₆
	TDHT1816	16 ³ / ₁₆ x 15 ¹ / ₁₆	13 ¹⁵ / ₁₆ x 12 ¹³ / ₁₆	12 ¹⁵ / ₁₆ x 11 ¹³ / ₁₆
	TDHT1818	16 ³ / ₁₆ x 17 ¹ / ₁₆	13 ¹⁵ / ₁₆ x 14 ¹³ / ₁₆	12 ¹⁵ / ₁₆ x 13 ¹³ / ₁₆
	TDHT1820	16 ³ / ₁₆ x 21 ¹ / ₁₆	13 ¹⁵ / ₁₆ x 18 ¹³ / ₁₆	12 ¹⁵ / ₁₆ x 17 ¹³ / ₁₆
20	TDHT2012	20 ³ / ₁₆ x 11 ¹ / ₁₆	17 ¹⁵ / ₁₆ x 8 ¹³ / ₁₆	16 ¹⁵ / ₁₆ x 7 ¹³ / ₁₆
	TDHT2014	20 ³ / ₁₆ x 13 ¹ / ₁₆	17 ¹⁵ / ₁₆ x 10 ¹³ / ₁₆	16 ¹⁵ / ₁₆ x 9 ¹³ / ₁₆
	TDHT2016	20 ³ / ₁₆ x 15 ¹ / ₁₆	17 ¹⁵ / ₁₆ x 12 ¹³ / ₁₆	16 ¹⁵ / ₁₆ x 11 ¹³ / ₁₆
	TDHT2018	20 ³ / ₁₆ x 17 ¹ / ₁₆	17 ¹⁵ / ₁₆ x 14 ¹³ / ₁₆	16 ¹⁵ / ₁₆ x 13 ¹³ / ₁₆
	TDHT2020	20 ³ / ₁₆ x 21 ¹ / ₁₆	17 ¹⁵ / ₁₆ x 18 ¹³ / ₁₆	16 ¹⁵ / ₁₆ x 17 ¹³ / ₁₆
24	TDHT2412	24 ³ / ₁₆ x 11 ¹ / ₁₆	21 ¹⁵ / ₁₆ x 8 ¹³ / ₁₆	20 ¹⁵ / ₁₆ x 7 ¹³ / ₁₆
	TDHT2414	24 ³ / ₁₆ x 13 ¹ / ₁₆	21 ¹⁵ / ₁₆ x 10 ¹³ / ₁₆	20 ¹⁵ / ₁₆ x 9 ¹³ / ₁₆
	TDHT2416	24 ³ / ₁₆ x 15 ¹ / ₁₆	21 ¹⁵ / ₁₆ x 12 ¹³ / ₁₆	20 ¹⁵ / ₁₆ x 11 ¹³ / ₁₆
	TDHT2418	24 ³ / ₁₆ x 17 ¹ / ₁₆	21 ¹⁵ / ₁₆ x 14 ¹³ / ₁₆	20 ¹⁵ / ₁₆ x 13 ¹³ / ₁₆
	TDHT2420	24 ³ / ₁₆ x 21 ¹ / ₁₆	21 ¹⁵ / ₁₆ x 18 ¹³ / ₁₆	20 ¹⁵ / ₁₆ x 17 ¹³ / ₁₆
26	TDHT2612	26 ³ / ₁₆ x 11 ¹ / ₁₆	23 ¹⁵ / ₁₆ x 8 ¹³ / ₁₆	22 ¹⁵ / ₁₆ x 7 ¹³ / ₁₆
	TDHT2614	26 ³ / ₁₆ x 13 ¹ / ₁₆	23 ¹⁵ / ₁₆ x 10 ¹³ / ₁₆	22 ¹⁵ / ₁₆ x 9 ¹³ / ₁₆
	TDHT2616	26 ³ / ₁₆ x 15 ¹ / ₁₆	23 ¹⁵ / ₁₆ x 12 ¹³ / ₁₆	22 ¹⁵ / ₁₆ x 11 ¹³ / ₁₆
	TDHT2618	26 ³ / ₁₆ x 17 ¹ / ₁₆	23 ¹⁵ / ₁₆ x 14 ¹³ / ₁₆	22 ¹⁵ / ₁₆ x 13 ¹³ / ₁₆
	TDHT2620	26 ³ / ₁₆ x 21 ¹ / ₁₆	23 ¹⁵ / ₁₆ x 18 ¹³ / ₁₆	22 ¹⁵ / ₁₆ x 17 ¹³ / ₁₆
28	TDHT2812	28 ³ / ₁₆ x 11 ¹ / ₁₆	25 ¹⁵ / ₁₆ x 8 ¹³ / ₁₆	24 ¹⁵ / ₁₆ x 7 ¹³ / ₁₆
	TDHT2814	28 ³ / ₁₆ x 13 ¹ / ₁₆	25 ¹⁵ / ₁₆ x 10 ¹³ / ₁₆	24 ¹⁵ / ₁₆ x 9 ¹³ / ₁₆
	TDHT2816	28 ³ / ₁₆ x 15 ¹ / ₁₆	25 ¹⁵ / ₁₆ x 12 ¹³ / ₁₆	24 ¹⁵ / ₁₆ x 11 ¹³ / ₁₆
	TDHT2818	28 ³ / ₁₆ x 17 ¹ / ₁₆	25 ¹⁵ / ₁₆ x 14 ¹³ / ₁₆	24 ¹⁵ / ₁₆ x 13 ¹³ / ₁₆
	TDHT2820	28 ³ / ₁₆ x 21 ¹ / ₁₆	25 ¹⁵ / ₁₆ x 18 ¹³ / ₁₆	24 ¹⁵ / ₁₆ x 17 ¹³ / ₁₆
30	TDHT3012	32 ³ / ₁₆ x 11 ¹ / ₁₆	29 ¹⁵ / ₁₆ x 8 ¹³ / ₁₆	28 ¹⁵ / ₁₆ x 7 ¹³ / ₁₆
	TDHT3014	32 ³ / ₁₆ x 13 ¹ / ₁₆	29 ¹⁵ / ₁₆ x 10 ¹³ / ₁₆	28 ¹⁵ / ₁₆ x 9 ¹³ / ₁₆
	TDHT3016	32 ³ / ₁₆ x 15 ¹ / ₁₆	29 ¹⁵ / ₁₆ x 12 ¹³ / ₁₆	28 ¹⁵ / ₁₆ x 11 ¹³ / ₁₆
	TDHT3018	32 ³ / ₁₆ x 17 ¹ / ₁₆	29 ¹⁵ / ₁₆ x 14 ¹³ / ₁₆	28 ¹⁵ / ₁₆ x 13 ¹³ / ₁₆
	TDHT3020	32 ³ / ₁₆ x 21 ¹ / ₁₆	29 ¹⁵ / ₁₆ x 18 ¹³ / ₁₆	28 ¹⁵ / ₁₆ x 17 ¹³ / ₁₆

E-Series Double-Hung Picture & Transom Windows (2007 to Present)

Standard Windows

Unit Sizes



Sash Size Table - Transom				
Unit No.	Overall Sash w x h	Overall Glass w x h	Unobstructed Glass w x h	
				
32	TDHT3212	34 ³ / ₁₆ x 11 ¹ / ₁₆	31 ¹⁵ / ₁₆ x 8 ¹³ / ₁₆	30 ¹⁵ / ₁₆ x 7 ¹³ / ₁₆
	TDHT3214	34 ³ / ₁₆ x 13 ¹ / ₁₆	31 ¹⁵ / ₁₆ x 10 ¹³ / ₁₆	30 ¹⁵ / ₁₆ x 9 ¹³ / ₁₆
	TDHT3216	34 ³ / ₁₆ x 15 ¹ / ₁₆	31 ¹⁵ / ₁₆ x 12 ¹³ / ₁₆	30 ¹⁵ / ₁₆ x 11 ¹³ / ₁₆
	TDHT3218	34 ³ / ₁₆ x 17 ¹ / ₁₆	31 ¹⁵ / ₁₆ x 14 ¹³ / ₁₆	30 ¹⁵ / ₁₆ x 13 ¹³ / ₁₆
	TDHT3220	34 ³ / ₁₆ x 21 ¹ / ₁₆	31 ¹⁵ / ₁₆ x 18 ¹³ / ₁₆	30 ¹⁵ / ₁₆ x 17 ¹³ / ₁₆
34	TDHT3412	36 ³ / ₁₆ x 11 ¹ / ₁₆	33 ¹⁵ / ₁₆ x 8 ¹³ / ₁₆	32 ¹⁵ / ₁₆ x 7 ¹³ / ₁₆
	TDHT3414	36 ³ / ₁₆ x 13 ¹ / ₁₆	33 ¹⁵ / ₁₆ x 10 ¹³ / ₁₆	32 ¹⁵ / ₁₆ x 9 ¹³ / ₁₆
	TDHT3416	36 ³ / ₁₆ x 15 ¹ / ₁₆	33 ¹⁵ / ₁₆ x 12 ¹³ / ₁₆	32 ¹⁵ / ₁₆ x 11 ¹³ / ₁₆
	TDHT3418	36 ³ / ₁₆ x 17 ¹ / ₁₆	33 ¹⁵ / ₁₆ x 14 ¹³ / ₁₆	32 ¹⁵ / ₁₆ x 13 ¹³ / ₁₆
	TDHT3420	36 ³ / ₁₆ x 21 ¹ / ₁₆	33 ¹⁵ / ₁₆ x 18 ¹³ / ₁₆	32 ¹⁵ / ₁₆ x 17 ¹³ / ₁₆
38	TDHT3812	40 ³ / ₁₆ x 11 ¹ / ₁₆	37 ¹⁵ / ₁₆ x 8 ¹³ / ₁₆	36 ¹⁵ / ₁₆ x 7 ¹³ / ₁₆
	TDHT3814	40 ³ / ₁₆ x 13 ¹ / ₁₆	37 ¹⁵ / ₁₆ x 10 ¹³ / ₁₆	36 ¹⁵ / ₁₆ x 9 ¹³ / ₁₆
	TDHT3816	40 ³ / ₁₆ x 15 ¹ / ₁₆	37 ¹⁵ / ₁₆ x 12 ¹³ / ₁₆	36 ¹⁵ / ₁₆ x 11 ¹³ / ₁₆
	TDHT3818	40 ³ / ₁₆ x 17 ¹ / ₁₆	37 ¹⁵ / ₁₆ x 14 ¹³ / ₁₆	36 ¹⁵ / ₁₆ x 13 ¹³ / ₁₆
	TDHT3820	40 ³ / ₁₆ x 21 ¹ / ₁₆	37 ¹⁵ / ₁₆ x 18 ¹³ / ₁₆	36 ¹⁵ / ₁₆ x 17 ¹³ / ₁₆
40	TDHT4012	44 ³ / ₁₆ x 11 ¹ / ₁₆	41 ¹⁵ / ₁₆ x 8 ¹³ / ₁₆	40 ¹⁵ / ₁₆ x 7 ¹³ / ₁₆
	TDHT4014	44 ³ / ₁₆ x 13 ¹ / ₁₆	41 ¹⁵ / ₁₆ x 10 ¹³ / ₁₆	40 ¹⁵ / ₁₆ x 9 ¹³ / ₁₆
	TDHT4016	44 ³ / ₁₆ x 15 ¹ / ₁₆	41 ¹⁵ / ₁₆ x 12 ¹³ / ₁₆	40 ¹⁵ / ₁₆ x 11 ¹³ / ₁₆
	TDHT4018	44 ³ / ₁₆ x 17 ¹ / ₁₆	41 ¹⁵ / ₁₆ x 14 ¹³ / ₁₆	40 ¹⁵ / ₁₆ x 13 ¹³ / ₁₆
	TDHT4020	44 ³ / ₁₆ x 21 ¹ / ₁₆	41 ¹⁵ / ₁₆ x 18 ¹³ / ₁₆	40 ¹⁵ / ₁₆ x 17 ¹³ / ₁₆
50	TDHT5012	56 ³ / ₁₆ x 11 ¹ / ₁₆	53 ¹⁵ / ₁₆ x 8 ¹³ / ₁₆	52 ¹⁵ / ₁₆ x 7 ¹³ / ₁₆
	TDHT5014	56 ³ / ₁₆ x 13 ¹ / ₁₆	53 ¹⁵ / ₁₆ x 10 ¹³ / ₁₆	52 ¹⁵ / ₁₆ x 9 ¹³ / ₁₆
	TDHT5016	56 ³ / ₁₆ x 15 ¹ / ₁₆	53 ¹⁵ / ₁₆ x 12 ¹³ / ₁₆	52 ¹⁵ / ₁₆ x 11 ¹³ / ₁₆
	TDHT5018	56 ³ / ₁₆ x 17 ¹ / ₁₆	53 ¹⁵ / ₁₆ x 14 ¹³ / ₁₆	52 ¹⁵ / ₁₆ x 13 ¹³ / ₁₆
	TDHT5020	56 ³ / ₁₆ x 21 ¹ / ₁₆	53 ¹⁵ / ₁₆ x 18 ¹³ / ₁₆	52 ¹⁵ / ₁₆ x 17 ¹³ / ₁₆

Unit Sizes

Sash Size Table - Picture

Note:



See FS00303 for additional information.

Sash Size Table - Picture				
Unit No.	Overall Sash w x h	Overall Glass w x h	Unobstructed Glass w x h	
	 Sash	 Glass		
30	TDHP3030	32 3/16 x 33 9/64	29 15/16 x 28 25/32	28 15/16 x 27 25/32
	TDHP3034	32 3/16 x 37 9/64	29 15/16 x 32 25/32	28 15/16 x 31 25/32
	TDHP3040	32 3/16 x 45 9/64	29 15/16 x 40 25/32	28 15/16 x 39 25/32
	TDHP3046	32 3/16 x 51 9/64	29 15/16 x 46 25/32	28 15/16 x 45 25/32
	TDHP3049	32 3/16 x 54 9/64	29 15/16 x 49 25/32	28 15/16 x 48 25/32
	TDHP3050	32 3/16 x 57 9/64	29 15/16 x 52 25/32	28 15/16 x 51 25/32
	TDHP3051	32 3/16 x 58 9/64	29 15/16 x 53 25/32	28 15/16 x 52 25/32
	TDHP3056	32 3/16 x 63 9/64	29 15/16 x 58 25/32	28 15/16 x 57 25/32
	TDHP3060	32 3/16 x 69 9/64	29 15/16 x 64 25/32	28 15/16 x 63 25/32
	TDHP3066	32 3/16 x 75 9/64	29 15/16 x 70 25/32	28 15/16 x 69 25/32
32	TDHP3230	34 3/16 x 33 9/64	31 15/16 x 28 25/32	30 15/16 x 27 25/32
	TDHP3234	34 3/16 x 37 9/64	31 15/16 x 32 25/32	30 15/16 x 31 25/32
	TDHP3240	34 3/16 x 45 9/64	31 15/16 x 40 25/32	30 15/16 x 39 25/32
	TDHP3246	34 3/16 x 51 9/64	31 15/16 x 46 25/32	30 15/16 x 45 25/32
	TDHP3249	34 3/16 x 54 9/64	31 15/16 x 49 25/32	30 15/16 x 48 25/32
	TDHP3250	34 3/16 x 57 9/64	31 15/16 x 52 25/32	30 15/16 x 51 25/32
	TDHP3251	34 3/16 x 58 9/64	31 15/16 x 53 25/32	30 15/16 x 52 25/32
	TDHP3256	34 3/16 x 63 9/64	31 15/16 x 58 25/32	30 15/16 x 57 25/32
	TDHP3260	34 3/16 x 69 9/64	31 15/16 x 64 25/32	30 15/16 x 63 25/32
	TDHP3266	34 3/16 x 75 9/64	31 15/16 x 70 25/32	30 15/16 x 69 25/32
34	TDHP3430	36 3/16 x 33 9/64	33 15/16 x 28 25/32	32 15/16 x 27 25/32
	TDHP3434	36 3/16 x 37 9/64	33 15/16 x 32 25/32	32 15/16 x 31 25/32
	TDHP3440	36 3/16 x 45 9/64	33 15/16 x 40 25/32	32 15/16 x 39 25/32
	TDHP3446	36 3/16 x 51 9/64	33 15/16 x 46 25/32	32 15/16 x 45 25/32
	TDHP3449	36 3/16 x 54 9/64	33 15/16 x 49 25/32	32 15/16 x 48 25/32
	TDHP3450	36 3/16 x 57 9/64	33 15/16 x 52 25/32	32 15/16 x 51 25/32
	TDHP3451	36 3/16 x 58 9/64	33 15/16 x 53 25/32	32 15/16 x 52 25/32
	TDHP3456	36 3/16 x 63 9/64	33 15/16 x 58 25/32	32 15/16 x 57 25/32
	TDHP3460	36 3/16 x 69 9/64	33 15/16 x 64 25/32	32 15/16 x 63 25/32
	TDHP3466	36 3/16 x 75 9/64	33 15/16 x 70 25/32	32 15/16 x 69 25/32

E-Series Double-Hung Picture & Transom Windows (2007 to Present)

Standard Windows

Unit Sizes

Sash Size Table - Picture				
Unit No.	Overall Sash w x h 	Overall Glass w x h 	Unobstructed Glass w x h	
38	TDHP3830	40 ³ / ₁₆ x 33 ⁹ / ₆₄	37 ¹⁵ / ₁₆ x 28 ²⁵ / ₃₂	36 ¹⁵ / ₁₆ x 27 ²⁵ / ₃₂
	TDHP3834	40 ³ / ₁₆ x 37 ⁹ / ₆₄	37 ¹⁵ / ₁₆ x 32 ²⁵ / ₃₂	36 ¹⁵ / ₁₆ x 31 ²⁵ / ₃₂
	TDHP3840	40 ³ / ₁₆ x 45 ⁹ / ₆₄	37 ¹⁵ / ₁₆ x 40 ²⁵ / ₃₂	36 ¹⁵ / ₁₆ x 39 ²⁵ / ₃₂
	TDHP3846	40 ³ / ₁₆ x 51 ⁹ / ₆₄	37 ¹⁵ / ₁₆ x 46 ²⁵ / ₃₂	36 ¹⁵ / ₁₆ x 45 ²⁵ / ₃₂
	TDHP3849	40 ³ / ₁₆ x 54 ⁹ / ₆₄	37 ¹⁵ / ₁₆ x 49 ²⁵ / ₃₂	36 ¹⁵ / ₁₆ x 48 ²⁵ / ₃₂
	TDHP3850	40 ³ / ₁₆ x 57 ⁹ / ₆₄	37 ¹⁵ / ₁₆ x 52 ²⁵ / ₃₂	36 ¹⁵ / ₁₆ x 51 ²⁵ / ₃₂
	TDHP3851	40 ³ / ₁₆ x 58 ⁹ / ₆₄	37 ¹⁵ / ₁₆ x 53 ²⁵ / ₃₂	36 ¹⁵ / ₁₆ x 52 ²⁵ / ₃₂
	TDHP3856	40 ³ / ₁₆ x 63 ⁹ / ₆₄	37 ¹⁵ / ₁₆ x 58 ²⁵ / ₃₂	36 ¹⁵ / ₁₆ x 57 ²⁵ / ₃₂
	TDHP3860	40 ³ / ₁₆ x 69 ⁹ / ₆₄	37 ¹⁵ / ₁₆ x 64 ²⁵ / ₃₂	36 ¹⁵ / ₁₆ x 63 ²⁵ / ₃₂
	TDHP3866	40 ³ / ₁₆ x 75 ⁹ / ₆₄	37 ¹⁵ / ₁₆ x 70 ²⁵ / ₃₂	36 ¹⁵ / ₁₆ x 69 ²⁵ / ₃₂
40	TDHP4030	44 ³ / ₁₆ x 33 ⁹ / ₆₄	41 ¹⁵ / ₁₆ x 28 ²⁵ / ₃₂	40 ¹⁵ / ₁₆ x 27 ²⁵ / ₃₂
	TDHP4034	44 ³ / ₁₆ x 37 ⁹ / ₆₄	41 ¹⁵ / ₁₆ x 32 ²⁵ / ₃₂	40 ¹⁵ / ₁₆ x 31 ²⁵ / ₃₂
	TDHP4040	44 ³ / ₁₆ x 45 ⁹ / ₆₄	41 ¹⁵ / ₁₆ x 40 ²⁵ / ₃₂	40 ¹⁵ / ₁₆ x 39 ²⁵ / ₃₂
	TDHP4046	44 ³ / ₁₆ x 51 ⁹ / ₆₄	41 ¹⁵ / ₁₆ x 46 ²⁵ / ₃₂	40 ¹⁵ / ₁₆ x 45 ²⁵ / ₃₂
	TDHP4049	44 ³ / ₁₆ x 54 ⁹ / ₆₄	41 ¹⁵ / ₁₆ x 49 ²⁵ / ₃₂	40 ¹⁵ / ₁₆ x 48 ²⁵ / ₃₂
	TDHP4050	44 ³ / ₁₆ x 57 ⁹ / ₆₄	41 ¹⁵ / ₁₆ x 52 ²⁵ / ₃₂	40 ¹⁵ / ₁₆ x 51 ²⁵ / ₃₂
	TDHP4051	44 ³ / ₁₆ x 58 ⁹ / ₆₄	41 ¹⁵ / ₁₆ x 53 ²⁵ / ₃₂	40 ¹⁵ / ₁₆ x 52 ²⁵ / ₃₂
	TDHP4056	44 ³ / ₁₆ x 63 ⁹ / ₆₄	41 ¹⁵ / ₁₆ x 58 ²⁵ / ₃₂	40 ¹⁵ / ₁₆ x 57 ²⁵ / ₃₂
	TDHP4060	44 ³ / ₁₆ x 69 ⁹ / ₆₄	41 ¹⁵ / ₁₆ x 64 ²⁵ / ₃₂	40 ¹⁵ / ₁₆ x 63 ²⁵ / ₃₂
	TDHP4066	44 ³ / ₁₆ x 75 ⁹ / ₆₄	41 ¹⁵ / ₁₆ x 70 ²⁵ / ₃₂	40 ¹⁵ / ₁₆ x 69 ²⁵ / ₃₂
50	TDHP5030	56 ³ / ₁₆ x 33 ⁹ / ₆₄	53 ¹⁵ / ₁₆ x 28 ²⁵ / ₃₂	52 ¹⁵ / ₁₆ x 27 ²⁵ / ₃₂
	TDHP5034	56 ³ / ₁₆ x 37 ⁹ / ₆₄	53 ¹⁵ / ₁₆ x 32 ²⁵ / ₃₂	52 ¹⁵ / ₁₆ x 31 ²⁵ / ₃₂
	TDHP5040	56 ³ / ₁₆ x 45 ⁹ / ₆₄	53 ¹⁵ / ₁₆ x 40 ²⁵ / ₃₂	52 ¹⁵ / ₁₆ x 39 ²⁵ / ₃₂
	TDHP5046	56 ³ / ₁₆ x 51 ⁹ / ₆₄	53 ¹⁵ / ₁₆ x 46 ²⁵ / ₃₂	52 ¹⁵ / ₁₆ x 45 ²⁵ / ₃₂
	TDHP5049	56 ³ / ₁₆ x 54 ⁹ / ₆₄	53 ¹⁵ / ₁₆ x 49 ²⁵ / ₃₂	52 ¹⁵ / ₁₆ x 48 ²⁵ / ₃₂
	TDHP5050	56 ³ / ₁₆ x 57 ⁹ / ₆₄	53 ¹⁵ / ₁₆ x 52 ²⁵ / ₃₂	52 ¹⁵ / ₁₆ x 51 ²⁵ / ₃₂
	TDHP5051	56 ³ / ₁₆ x 58 ⁹ / ₆₄	53 ¹⁵ / ₁₆ x 53 ²⁵ / ₃₂	52 ¹⁵ / ₁₆ x 52 ²⁵ / ₃₂
	TDHP5056	56 ³ / ₁₆ x 63 ⁹ / ₆₄	53 ¹⁵ / ₁₆ x 58 ²⁵ / ₃₂	52 ¹⁵ / ₁₆ x 57 ²⁵ / ₃₂
	TDHP5060	56 ³ / ₁₆ x 69 ⁹ / ₆₄	53 ¹⁵ / ₁₆ x 64 ²⁵ / ₃₂	52 ¹⁵ / ₁₆ x 63 ²⁵ / ₃₂
	TDHP5066	56 ³ / ₁₆ x 75 ⁹ / ₆₄	53 ¹⁵ / ₁₆ x 70 ²⁵ / ₃₂	52 ¹⁵ / ₁₆ x 69 ²⁵ / ₃₂

Product History

Product History

- 2022** White Oak introduced
- 2022** Stormwatch® (not shown in catalog) discontinued. See [Bulletin 80-21](#) for more detail.

Sash Graphic - Transom

Note:

See current Transom Window sash [Product Details](#). See FS00304.

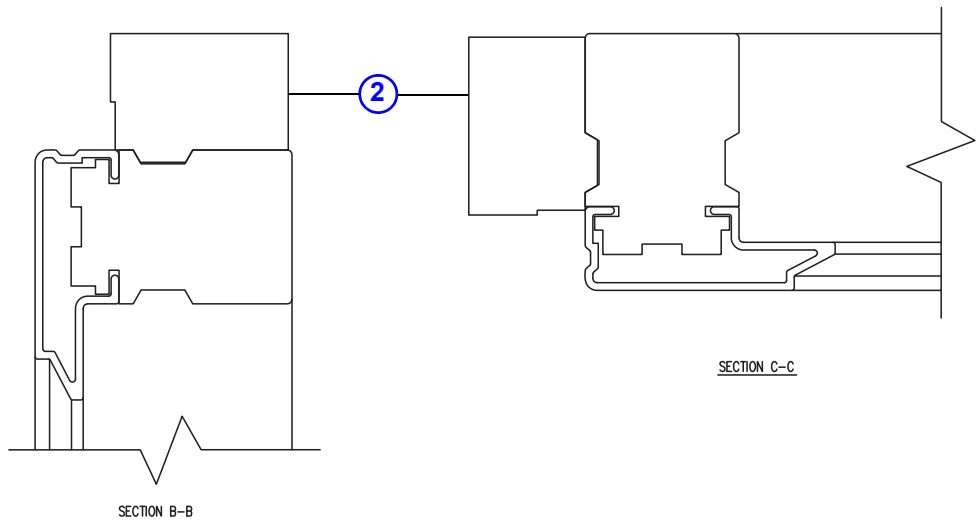

1. [Sash](#)
2. [Stop \(Head, Side\)](#)
3. [Glass](#)

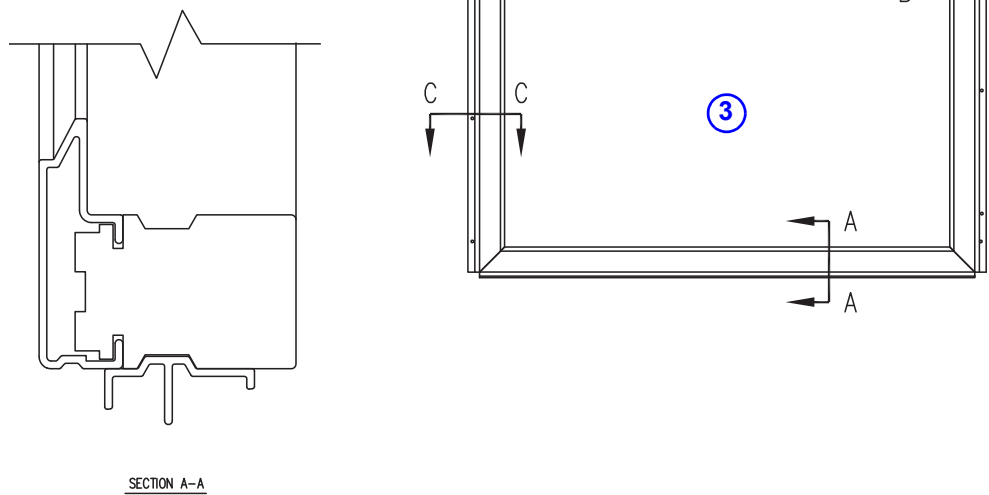

Sash

Sash Graphic - Picture

Note:
See current Picture Window sash [Product Details](#). See FS00303.

- 1. [Sash](#)
- 2. [Stop \(Head, Side\)](#)
- 3. [Weatherstrip](#)
- 4. [Sash Wedge](#)
- 5. [Glass](#)

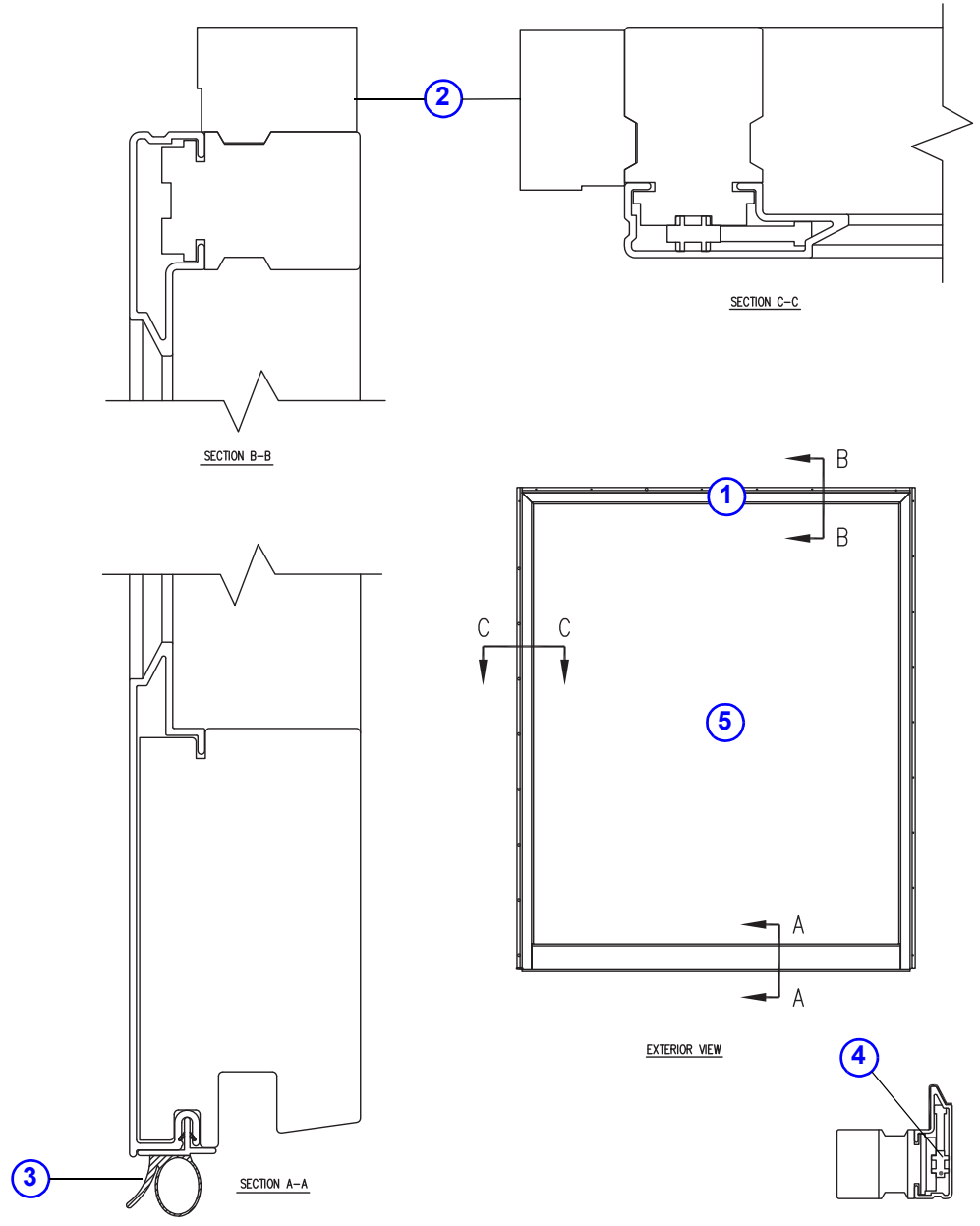

Sash Options

Sash - Standard Window

Note:

Replacement sash for windows are made to order and can be configured through iQ+. Current glazings replace previous vintage glazings. Product ID label is located on the head jamb.



TEMPERED UA
16 CFR 1201 II
ANSI Z97.1 2009
SGCC XXXX
CIG-XX Xmm MM/DD/YR
CAN/CGSB 12.1-M90

Exterior color options:

Interior species/finish/color options:

Glass options (See Logo/Etching Examples):

Low-E4®	Low-E4® HeatLock	Low-E4® Triple-Pane
Low-E4® SmartSun™	Low-E4® Smart-Sun HeatLock	Low-E4® Smart-Sun Triple-Pane
Low-E4® Passive Sun	Low-E4® Sun Heat-Lock	Low-E4® Enhanced Triple-Pane
Low-E4® Sun 3	Low-E4® HeatLock Tempered	Low-E4® Smart-Sun Enhanced Triple-Pane
Low-E4® Tempered	Dual Pane Clear	Low-E4® Enhanced Triple-Pane Heat-Lock
Low-E4® SmartSun Tempered	Cascade	Low-E4® Smart-Sun Enhanced Triple-Pane HeatLock
Low-E4® Passive Sun Tempered	Fern	
Low-E4® Sun Tempered	Reed	

To order, state:

Product ID (from product label, see [Service Guide 9051877](#))

OR

1. Unit or frame size (TDHP/TDHT XXXX or frame W x H dimensions)
2. Description of part (Sash)
3. Exterior color of sash
4. Interior wood species/finish/color of sash
5. Glass stop profile (Ovolo, Contemporary)
6. Glazing/Grille type

Sash

Weatherstrip

Weatherstrip

Note:

Used on bottom rail. See [Service Guide 9069157](#).

		Color	Size	Order No.
		Beige	144"	0034815

Sash Components / Miscellaneous

Sash Wedge Ref. 4 [page 14](#)

Note:

Used with picture window.

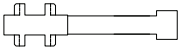
		Order No.
		0016764

E-Series Double-Hung Picture & Transom Windows (2007 to Present)

Standard Windows

Glass

Glass

Glass Ref. 5 [page 3](#) Ref. 3 [page 13](#) Ref. 5 [page 14](#)

Note:

Replacement glass is made to order and can be configured through iQ+. Current glazings replace previous vintage glazings. Product ID label is located on the head jamb. Glass ships with sealant and spacers. See [Accessory Guide 9176386](#).



TEMPERED
16 CFR 1201 II
ANSI Z97.1 2009
SGCC XXXX
CIG-XX Xmm MM/DD/YR
CAN/CGSB 12.1-M90

Exterior color options:

Interior species/finish/color options:

Glass options (See Logo/Etching Examples):

Low-E4®	Low-E4® HeatLock	Low-E4® SmartSun HeatLock
Low-E4® SmartSun™	Low-E4® Smart-Sun HeatLock	Low-E4® Triple-Pane
Low-E4® Passive Sun	Low-E4® Sun Heat-Lock	Low-E4® Smart-Sun Triple-Pane
Low-E4® Sun 3	Low-E4® HeatLock Tempered	Low-E4® Enhanced Triple-Pane
Low-E4® Tempered	Dual Pane Clear	Low-E4® Smart-Sun Enhanced Triple-Pane
Low-E4® SmartSun Tempered	Cascade	Low-E4® Enhanced Triple-Pane Heat-Lock
Low-E4® Passive Sun Tempered	Fern	Low-E4® Smart-Sun Enhanced Triple-Pane HeatLock
Low-E4® Sun Tempered	Reed	

To order, state:

Product ID (from product label, see [Service Guide 9051877](#))

OR

1. Unit or frame size (TDHP/TDHT XXXX or frame W x H dimensions)
2. Description of part (Glass)
3. Glazing/Grille type
4. Glass Stop Type (Ovolo, Contemporary)
5. Manufacturing Date

Glass

Glass Stops

Stops - Top / Bottom / Side

Note:

Stops (top, bottom and side) are made to order.

To order, state:

Product ID (from product label, see [Service Guide 9051877](#))

OR

1. Description of Part/Size (Stop)
2. Color/Species/Finish
3. Location/Handing (Top, Bottom, Side)
4. Type (Ovolo, Contemporary)
5. Manufacturing Date

Interior species/finish/color options

WOOD SPECIES

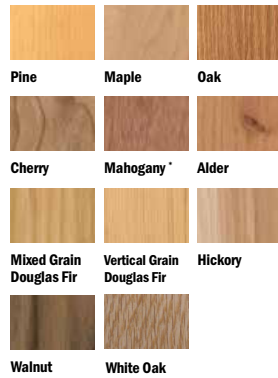

FACTORY-FINISHED INTERIORS



PAINTED OPTIONS



E-Series Double-Hung Picture & Transom Windows (2007 to Present)

Standard Windows

Glass

Glass Parts			
Glazing Tape			
Note: See Accessory Guide 9064542 .			
		Color	Order No.
		Gray	33751RL
Silicone Bed Glazing			
		Color	Order No.
		Dove Gray	9164412

Grilles

Grilles

Note:

Replacement sash with permanently applied grilles and finelight grilles can be configured in iQ+. Replacement removable interior grilles can be configured in iQ+. Removable grilles are only available in 7/8" profile.

Exterior color/finish options



ANNODIZED FINISHES



Interior species/finish/color options

WOOD SPECIES

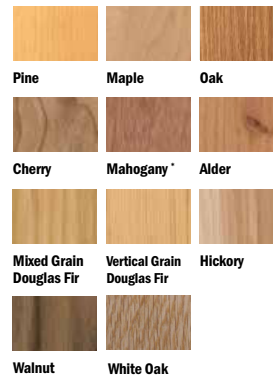

FACTORY-FINISHED INTERIORS



PAINTED OPTIONS



Painted options available with pine and maple only.

Grille Options

Note:

Replacement sash with permanently applied grilles and finelight grilles can be configured in iQ+. Replacement removable interior grilles can be configured in iQ+. Removable grilles are only available in 7/8" profile.

Types



Full Divided Light

Give any window an authentic look with full divided light grilles that are permanently applied to the interior and exterior of your window with a spacer between the glass.



Simulated Divided Light

An economical solution with traditional beauty, our Simulated Divided Light features fixed exterior and interior grilles without an internal spacer.



Removable Interior Wood Grilles

Our removable wood grilles are installed on the interior surface. They are available with an optional surround and an optional permanently applied exterior grille.



Finelight™ Grilles-Between-the-Glass

Aluminum grilles conveniently placed between two panes of glass make the glass easy to clean inside and out.

Profiles

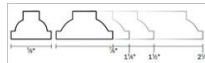

Interior Wood: Ovolo (Colonial)

Widths:

- 5/8"
- 7/8"
- 1 1/8"
- 1 1/2"
- 2 1/4"

Available with:

- Full Divided Light
- Simulated Divided Light

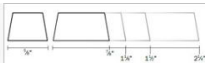

Interior Wood: Contemporary

Widths:

- 5/8"
- 7/8"
- 1 1/8"
- 1 1/2"
- 2 1/4"

Available with:

- Full Divided Light
- Simulated Divided Light

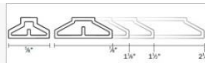

Exterior Aluminum: Chamfer

Widths:

- 5/8"
- 7/8"
- 1 1/8"
- 1 1/2"
- 2 1/4"

Available with:

- Full Divided Light
- Simulated Divided Light
- Removable Interior Wood with Optional Permanently Applied Exterior Grille

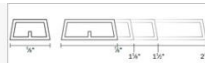

Exterior Aluminum: Contemporary

Widths:

- 5/8"
- 7/8"
- 1 1/8"
- 1 1/2"
- 2 1/4"

Available with:

- Full Divided Light
- Simulated Divided Light
- Removable Interior Wood with Optional Permanently Applied Exterior Grille

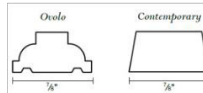

Removable Interior Wood Grilles

Ovolo or Contemporary profiles in 7/8" width

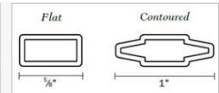

Finelight Grille Profiles and Widths

Flat or Contoured profiles in 5/8" or 1" widths

Patterns

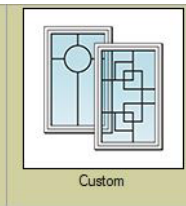
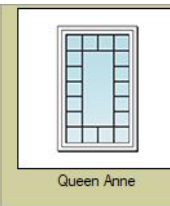
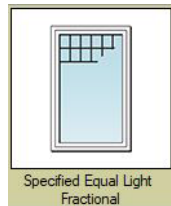
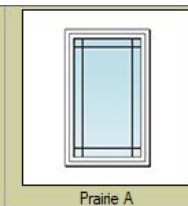
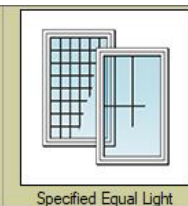
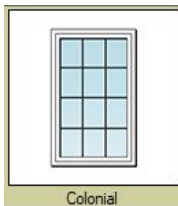

Grilles

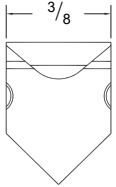
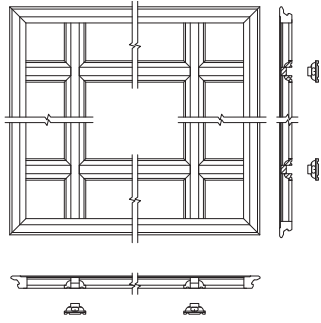
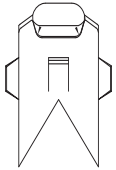
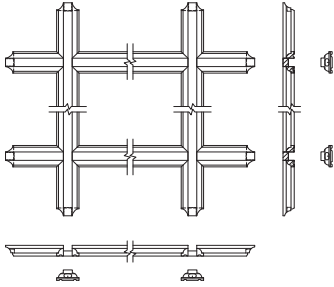
Interior Grille Parts				
Clip - Surround				
Note: Used with framed removable grilles.				
		<table border="1" style="width: 100%; border-collapse: collapse;"> <tr> <td style="padding: 5px;">Order No.</td> </tr> <tr> <td style="padding: 5px; text-align: center;">0004900</td> </tr> </table>	Order No.	0004900
Order No.				
0004900				
Clip - Knocked Down				
Note: Used with knocked down removable grilles.				
		<table border="1" style="width: 100%; border-collapse: collapse;"> <tr> <td style="padding: 5px;">Order No.</td> </tr> <tr> <td style="padding: 5px; text-align: center;">0004901</td> </tr> </table>	Order No.	0004901
Order No.				
0004901				

E-Series Double-Hung Picture & Transom Windows (2007 to Present)

Standard Windows

Frames

Frame Graphic - Standard Windows

Note:

Double-Hung Picture frame shown. See current frame [Product Details](#) (Double-Hung Transom shown as well).

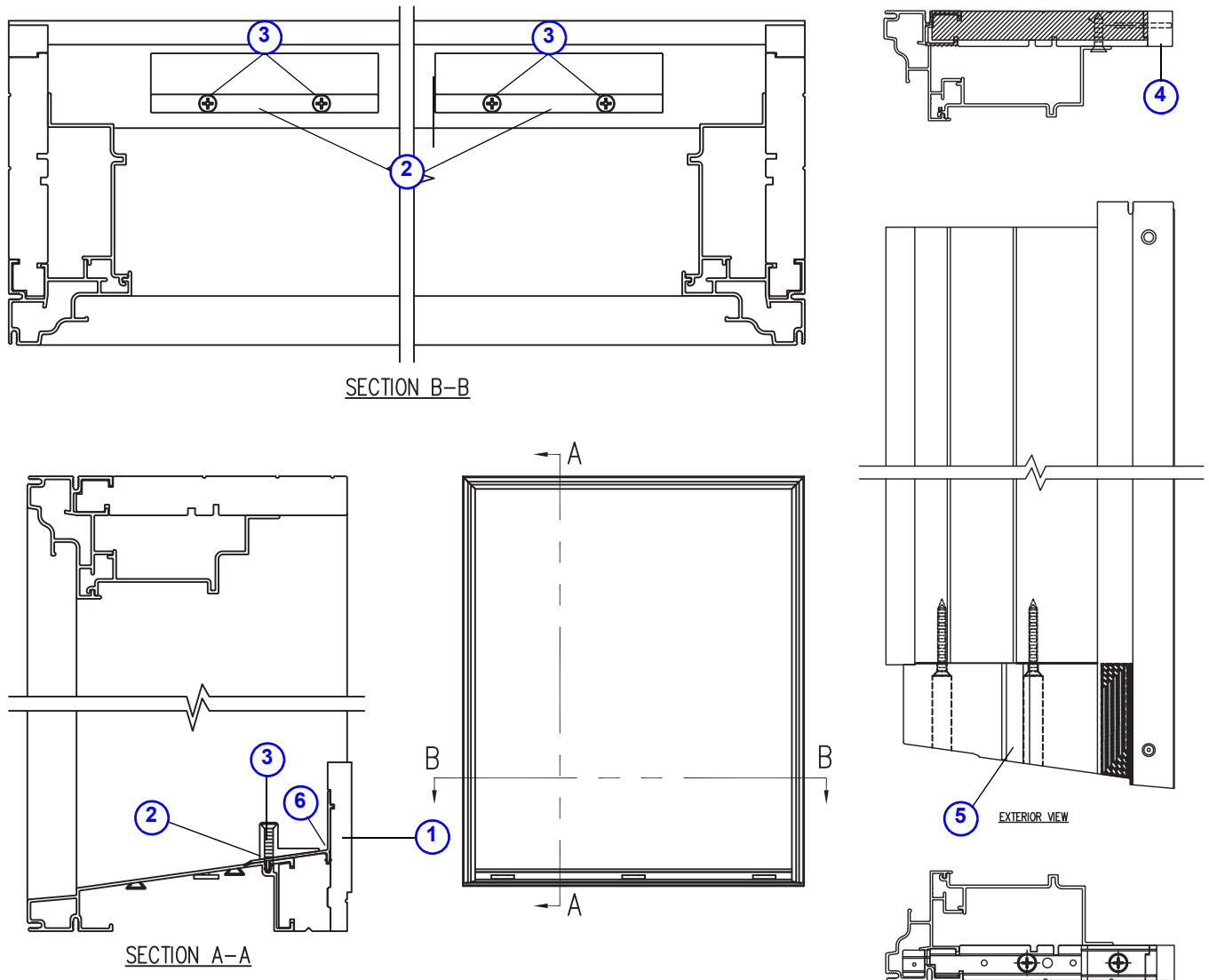

- 1. [Sill Stop](#)
- 2. [Snubber](#)
- 3. [Screw \(Snubber\)](#)
- 4. [Filler Block](#)
- 5. [Corner Block](#)
- 6. [Water Dam](#)

E-Series Double-Hung Picture Frame Assembly

Frames

Frame

Note:

Replacement frames can be configured in iQ+.

To order, state:

Product ID (from product label, see [Service Guide 9051877](#))

OR

1. Description of Part/Size (TDHP/TDHT XXXX or frame W X H dimensions)
2. Colors/Species/Finish
3. Manufacturing Date

Exterior color/finish options



ANNODIZED FINISHES



Interior species/finish/color options

WOOD SPECIES

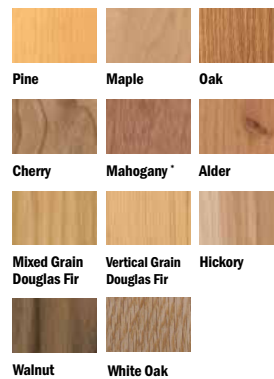

FACTORY-FINISHED INTERIORS

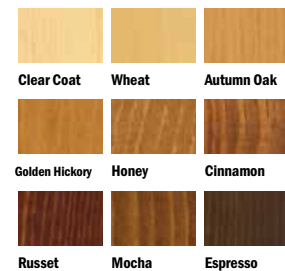

PAINTED OPTIONS



Stops

Stops - Head / Sill / Side Ref. 1 [page 23](#)

Note:

Stops (interior head, interior side, interior sill, support) are made to order.

To order, state:

Product ID (from product label, see [Service Guide 9051877](#))

OR

1. Description of Part/Size (Interior Stop)
2. Color/Species/Finish
3. Location/Handing/Type (Head, Side, Sill, Support)
4. Manufacturing Date

Interior species/finish/color options

WOOD SPECIES

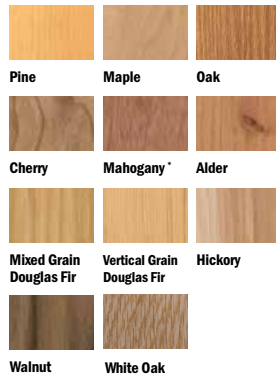

FACTORY-FINISHED INTERIORS



PAINTED OPTIONS



Frames

Hardware and Frame Parts

Filler Block Ref. 8 [page 3](#) & Ref. 4 [page 23](#)

Note:

Sizes not shown available by description.

To order, state:

Product ID (from product label, see [Service Guide 9051877](#))

AND

1. Unit or frame size (TDHP/TDHT XXXX or frame W x H dimensions)
2. Color/Species/Finish

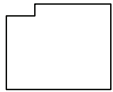
		Size	Length	Order No.
		1-2	11 ⁵ / ₁₆	0090651
		1-4	13 ⁵ / ₁₆	0090652
		2-4	25 ⁵ / ₁₆	0090657
		3-0	32 ¹⁷ / ₃₂	0090660
		3-4	37 ⁵ / ₁₆	0090661
		4-0	45 ⁵ / ₁₆	0090662
		4-6	51 ⁵ / ₁₆	0090663
		5-0	57 ⁵ / ₁₆	0090664
		5-1	57 ¹⁷ / ₃₂	0018941
		5-6	63 ⁵ / ₁₆	0090665
		6-0	69 ⁵ / ₁₆	0090666
		6-6	75 ⁵ / ₁₆	0090667
	8-0	96	0084185	

Corner Block Ref. 5 [page 23](#)

Note:

Used with picture window.

		LH	RH
		0014068	0014069

Snubber Ref.2 [page 23](#)

Note:

Used with picture window. Units wider than 20" use three snubbers.

		Order No.
		0034868

Screw - Snubber

	Description	Order No.
	#7 x 7/8" PFH SMS Type AB SS	0015746

E-Series Double-Hung Picture & Transom Windows (2007 to Present)

Standard Windows

Frames

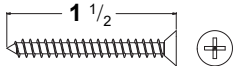
Screw - Jamb		
	Description	Order No.
	#8 x 1 1/2" PFHSMS Type AB Z & Y	0033462

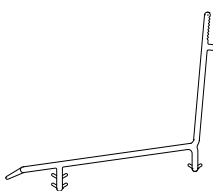
Water Dam / Sill Ref. 6 page 23			
Note: Used with picture window.			
		Length	Order No.
		12 ft (144")	0011586
		8 ft 6 in (102")	0653660

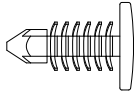
Plug / Sill		
Note: Used with picture window.		
		Order No.
		0014070

Frames
