

Retractable Insect Screen Sill Shim

Application Instructions for:



- **Product Series** - Big Doors
- **Product Type** - Folding Outswing Door
- **Frame Configuration** - On-Floor Drainage Sill, and On-Floor Drainage Sill with Raised Threshold

Read these instructions and the Product Safety Information before starting procedure.

Para obtener una versión en español de esta guía, visite el sitio www.andersenwindows.com

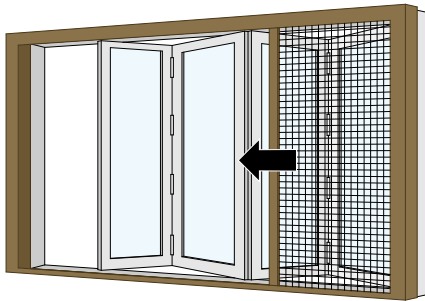

One-Direction (RIGHT)

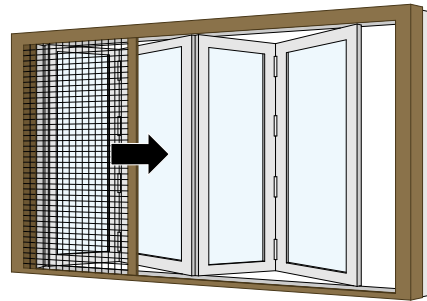

One-Direction (LEFT)

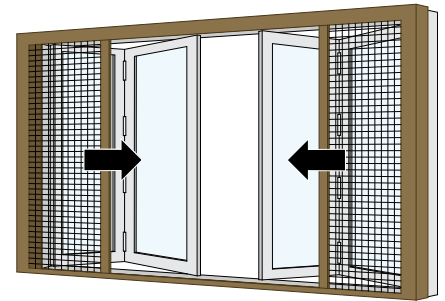

Two-Direction

Folding Outswing Doors

Typical Tools Needed



Safety Glasses



Protective Gloves



Tape Measure

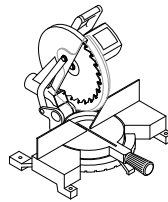

Miter Saw

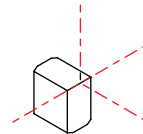

Laser Level

Parts Included

IMPORTANT

This Retractable Insect Screen sill shim must be used for Outswing Folding Door sill clip clearance when installing the Retractable Insect Screen. Failure to do so will result in Folding Outswing Door sill clip interference.

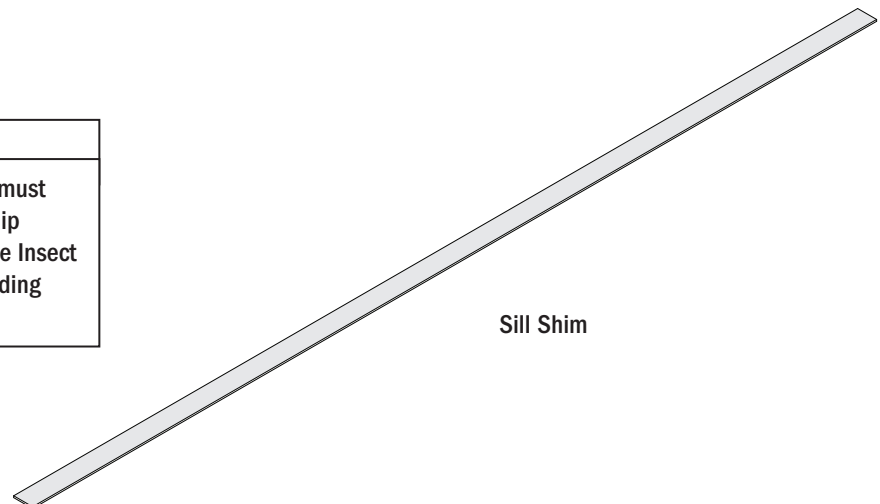

Sill Shim



Important Safety and Product Information

for Andersen® Windows and Doors



This is the Safety Alert Symbol used to alert you to potential injury hazards. Obey all safety messages that follow this symbol to avoid possible injury or death.

Signal Word and Consequence

COULD Result in:	 WARNING Major Injury/Death	COULD Result in:	 CAUTION Minor Injury
COULD Result in:	NOTICE Product or Property Damage		IMPORTANT Procedure and Product Information

Read this Important Safety and Product Information completely before starting.

Safety and Product Information Index

- Tools
- Handling
- Installation
- Sealing
- Fastening
- Finishing
- Glass
- Protective Film
- Cleaning
- Use/Operation
- Joining
- Product Information

- Leave this installation instruction with the home/building owner.
- For additional support or help please go to: andersenwindows.com and visit our Help Center.
- To configure installation instructions go to: andersenwindows.com/installation

Tools

WARNING

- Follow manufacturers' instructions for hand and power tools. Always wear safety glasses. Failure to do so could result in injury, product or property damage.

Handling

WARNING

- Windows and doors can be heavy. Use safe lifting techniques and a reasonable number of people with enough strength to lift, carry, and install window and door products. Heavier windows and doors will require mechanical assistance. Failure to do so could result in injury, product or property damage.
- **DO NOT** lift or carry window or door by the exterior trim or extension jambs. Doing so could result in injury, product or property damage.
- Windows, doors, and installation components can have sharp edges. Wear protective equipment when handling. Failure to do so could result in injury.
- **DO NOT** drag, rock, cartwheel, or walk windows, doors, sash, or panels across the floor. Doing so could result in product or property damage.

Installation

WARNING

- Use caution when working at elevated heights and around window and door openings. Follow the manufacturers' instructions for ladders and scaffolding. Failure to do so could result in injury or death.
- Support window or door in opening at all times until fully fastened. Failure to do so could result in window or door falling out causing injury, property or product damage.
- Windows and doors have small parts (e.g. hole plugs, operator spline caps, fasteners, etc.). Small parts if swallowed could pose a choking hazard to young children. Dispose of unused, loose, or easily removed small parts. Failure to do so could result in injury.

Installation (Continued)

NOTICE

- Andersen head flashing and installation flanges **DO NOT** take the place of window and door flashing tape or liquid flashing. Window or door must be properly flashed and sealed with a material compatible sealant for protection against water and air infiltration. Failure to do so could result in product or property damage.
- **DO NOT** set window or door directly on installation flange. Doing so could affect product performance, and could result in product or property damage.
- **DO NOT** set window directly on sill plate. Elevate window with shims under the side jambs. Failure to do so could affect operation and product performance, and could result in product damage.
- Window or door must be properly shimmed. Failure to do so could affect operation and product performance, and could result in product damage.
- A continuous full perimeter interior seal between window or door frame and opening is required. Failure to do so will affect product performance, and could result in product or property damage.
- Protect window and door sills during installation and throughout construction. Failure to do so could result in product damage.
- **DO NOT** remove window or door packaging material until instructed to do so. Doing so could result in product damage.

Sealing

CAUTION

- Follow instructions of foam, sealant, and flashing manufacturers regarding safety, material application, compatibility, and periodic maintenance for continued weather resistance of their products. Failure to do so could result in injury, product or property damage.

NOTICE

- Clean and prepare surfaces receiving sealant following sealant manufacturer's instructions. Failure to do so could result in water infiltration causing product or property damage.
- **DO NOT** use abrasive cleaners or solvents when cleaning Fibrex® material. Doing so could result in product damage. Go to andersenwindows.com for a list of recommended cleaners.

Fastening

WARNING

- Metal fasteners and components could corrode when exposed to preservative-treated or fire-retardant treated lumber. Use approved fasteners and components to fasten window or door. Failure to do so could cause a failure resulting in injury, product or property damage.
- Fastener must attach to a structural framing member with a 1-1/2" minimum fastener embedment. Failure to do so could result in injury, product or property damage.
- **DO NOT** remove screws that attach installation clips or gusset plates to window or door frames. Doing so could result in injury, product or property damage.

NOTICE

- Use masonry screws when fastening directly into masonry or through a buck into masonry. Failure to do so could affect product performance, and could result in product or property damage.
- **DO NOT** over drive screws or nails. Doing so could result in product damage.
- Fasteners must be attached to a structural framing member. Failure to do so will reduce the structural performance to less than published values and could affect product performance, and could result in product or property damage.

Finishing

NOTICE

- **DO NOT** stain or paint weatherstrip, vinyl, glass, or hardware. Doing so could result in product damage.
- Read and follow finish manufacturer's instructions and safety information. Failure to do so could result in product damage.
- **DO NOT** over load brush with stain or paint when finishing. Doing so could allow finish to wick between glass stop or grille, and glass.

Finishing (Continued)

NOTICE

- Finish all wood surfaces immediately after installation. Unfinished wood will deteriorate, discolor, and could bow or split. Some surfaces are hidden from view.

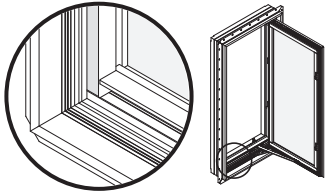

- Some products are shipped unassembled, and it may be more convenient to finish wood surfaces for these products prior to assembly and installation.

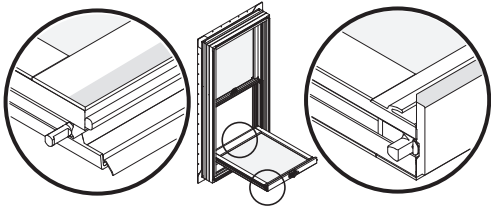

Glass

WARNING

- Unless specifically ordered, Andersen windows are not equipped with safety glass, and if broken, could fragment causing injury. Many laws and building codes require safety glass in locations adjacent to or near doors. Andersen windows are available with safety glass that could reduce the likelihood of injury when broken. Information on safety glass is available from your local Andersen dealer.

- Tempered or laminated safety glass is not standard for windows and must be special ordered. Check local building codes for required locations. Failure to do so could result in injury, product or property damage.

NOTICE

- **DO NOT** apply any type of film to insulating glass. Doing so could cause thermal stress conditions and result in glass damage. Shading devices (e.g. insulated coverings, shutters, etc.) could also cause thermal stress and condensation causing deterioration of windows or doors.

- **DO NOT** use sealants on exterior or interior glass surface.

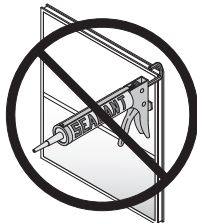

Protective Film

WARNING

- **DO NOT** place suction grips over film seams on glass. Suction grips will not hold if placed over film seam to lift or move window or door. Window or door will fall and could result in injury, product or property damage.



- **DO NOT** remove any protective film near flammable materials. Static charge created when removing film can ignite flammable materials or cause a shock. Doing so could result in injury, product or property damage. See warning label on glass.

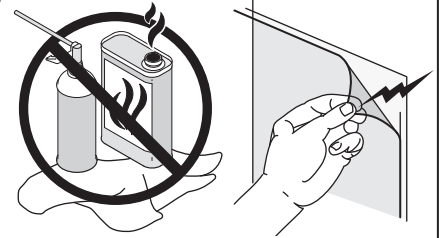

- Dispose of protective film immediately after removing. Failure to do so could pose a suffocation hazard to children.

NOTICE

- **DO NOT** remove protective film from glass until after construction is completed. Doing so could allow glass to be damaged.

- Remove protective film from non-glass components immediately after installation. Failure to do so could result in product damage.

Cleaning

NOTICE

- Acid solutions used for cleaning masonry or concrete will damage all components of window or doors. Protect window or door and follow cleaning product manufacturer's instructions. If acid contacts window or door, wash all surfaces immediately with clean water.

- **DO NOT** use or apply solvents, abrasives, harsh chemicals or cleaners to window or door components. Doing so will result in product damage. For a list of recommended cleaners go to: andersenwindows.com

- **DO NOT** use metal razor blades to clean glass surface. Glass damage could result.

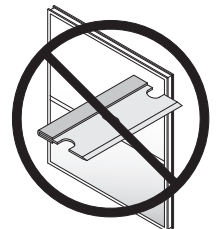

Use/Operation

WARNING

- **DO NOT** stand in front of or near windows or doors during a storm. Doing so could result in injury. Accessories such as grilles, art glass, and insect screens could dislodge and become airborne if window or door is impacted by wind-borne debris from severe storms or hurricane strength winds. In the event of a storm, remove all accessories from windows or doors and move to a safe location.

- **DO NOT** install air conditioner in window. Doing so could result in injury, product or property damage.

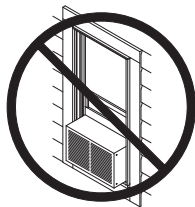

- Wind load brackets must be flipped out when not tilting or cleaning. If wind load brackets are not flipped out, window could blow in resulting in potential injury and/or product damage.

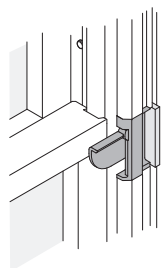

Flipped Out

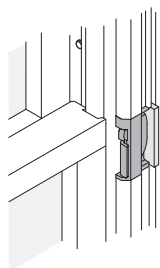

Flipped In

CAUTION

- **DO NOT** attach objects or accessories to window or door except Andersen® products specifically designed for the window or door. Doing so could result in injury, product or property damage.

Joining

WARNING

- **DO NOT** join any window or door, horizontally or vertically, to any window or door not designed for joining. Doing so could result in injury, product or property damage.

- Joined windows or doors must be individually supported in the opening. Failure to do so could affect operation and product performance, and could result in product or property damage.

Product and General Information

IMPORTANT

- Buildings constructed prior to 1978 could contain lead paint which could be disturbed during window or door replacement. For more information on proper management of lead paint, go to: www.epa.gov/lead

- Instructions may not be right for all installations due to building design, construction materials, or methods used and/or building or site conditions. Consult a contractor or architect for recommendations.

- Installation flanges may need to be removed for some installations. (e.g. masonry, replacement), or where exterior finish is already applied (e.g. siding, brick veneer, stucco).

- Installation flange on the window or door alone will not properly flash and seal the window or door.

- **DO NOT** remove band, plastic ties, or packing clips from window or door until instructed.

- **DO NOT** remove performance (NFRC) label until after final inspection. Doing so could delay final inspection and sign-off by the code official.

- Check with your local building code official to identify and confirm compliance with local building code requirements.

- Contact local authorities or waste management company for proper recycling and disposal instructions for removed window or door.

- For cleaning instructions for window and door components go to: andersenwindows.com.

- During construction protect products from construction debris, harsh chemical such as brick wash, roof runoff, and cement/masonry which can cause damage to window and door products.

- Protective film is not present on all windows or doors. Protective film is not a substitute for masking.

- Remove protective film from glass within six (6) months of installation and when temperature is above 32° F.

- Remove protective film by peeling from seam or corner. Use a plastic scraper to start if needed.

- Extension jambs can be factory applied on some windows or field applied prior to installation. **DO NOT** apply extension jambs prior to window or door installation that will be fastened with installation clips. Doing so could prevent access to installation clips for fastening.

- For extension jamb application refer to instructions included with part(s) or go to: andersenwindows.com

- Use painters masking tape for protecting products during construction. Avoid using duct or packaging tapes.

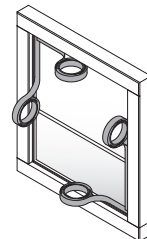

1

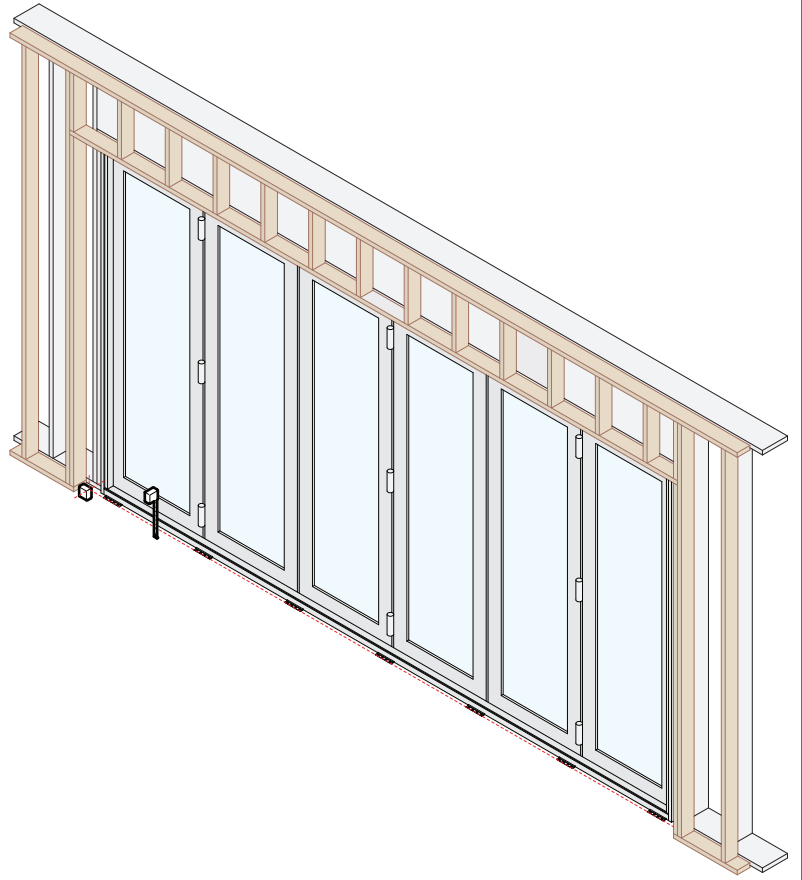
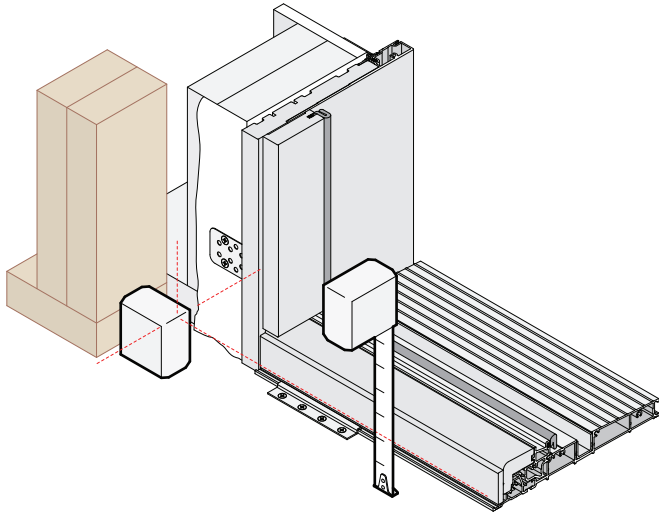

Verify the retractable insect screen's sill shim area is level and clear of all debris. Correct as needed.

2

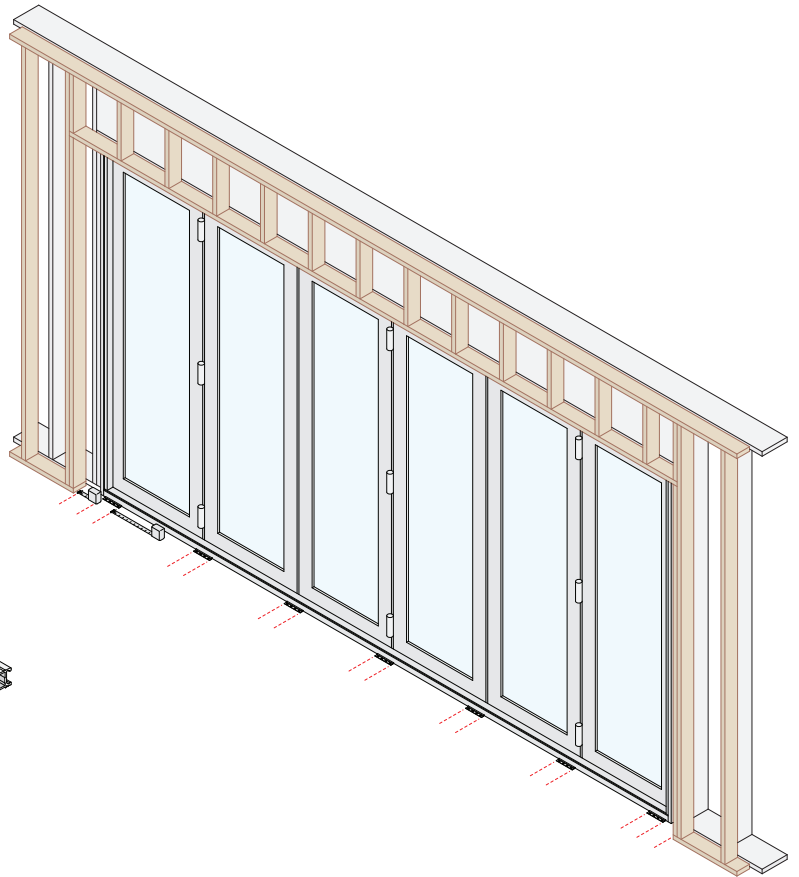
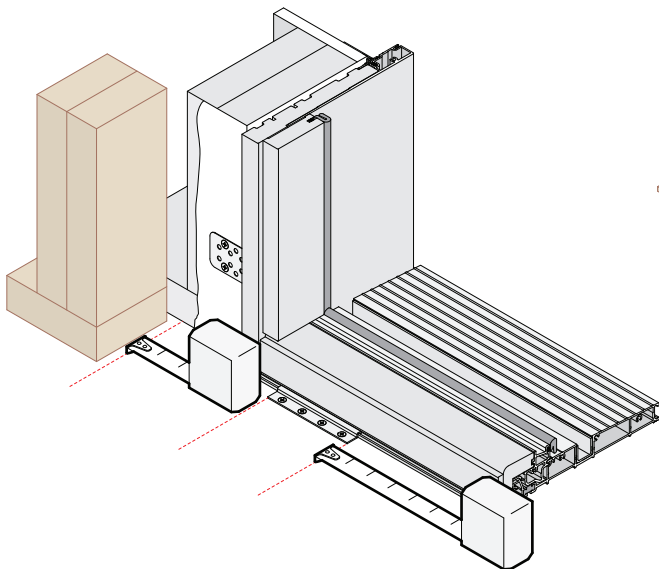

Measure and cut the sill shim to fit between the sill clips, and between the sill clips and the retractable insect screen rough opening.

3

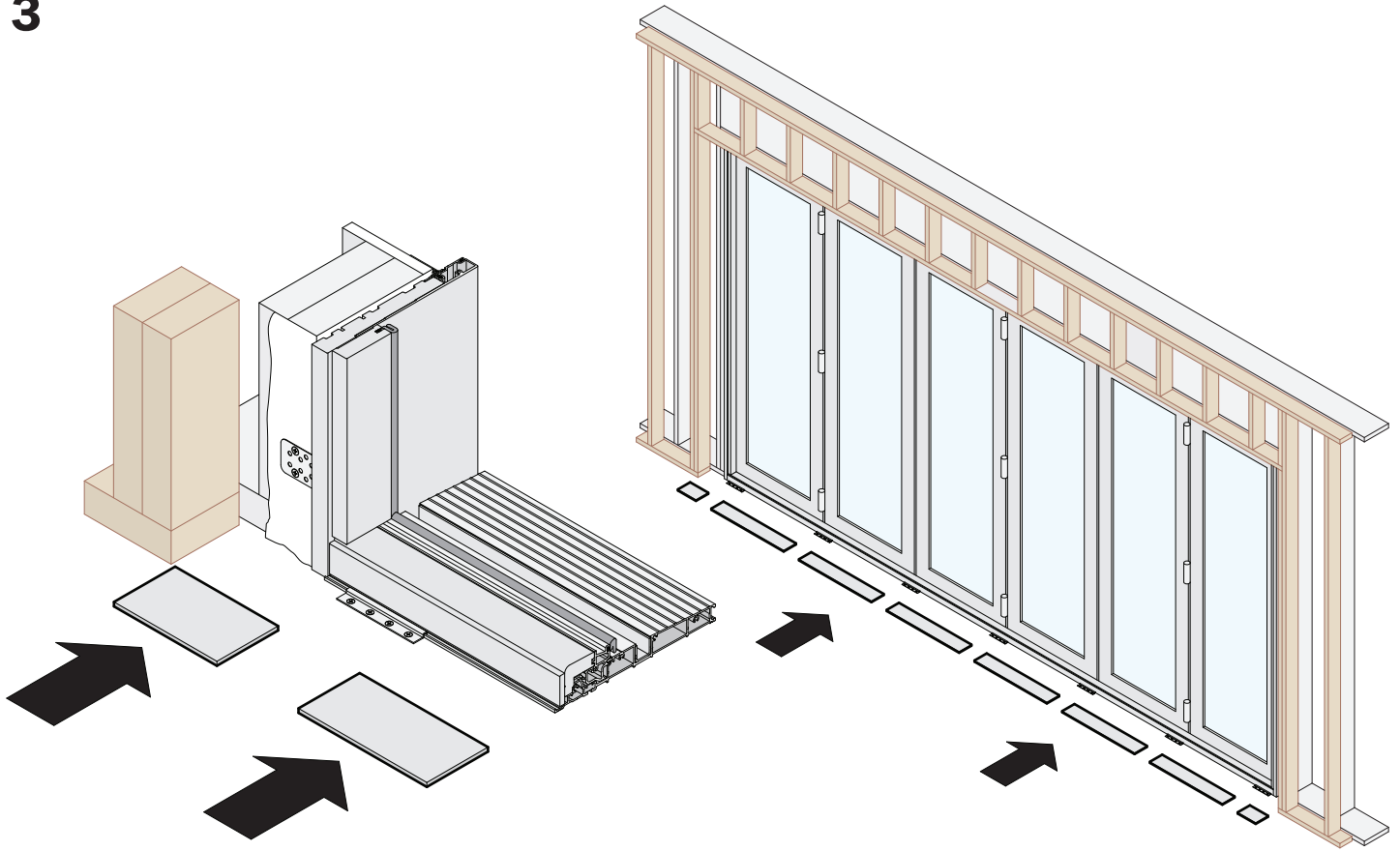

Position the sill shims between the sill clips and between the sill clips and the retractable insect screen rough opening.

4

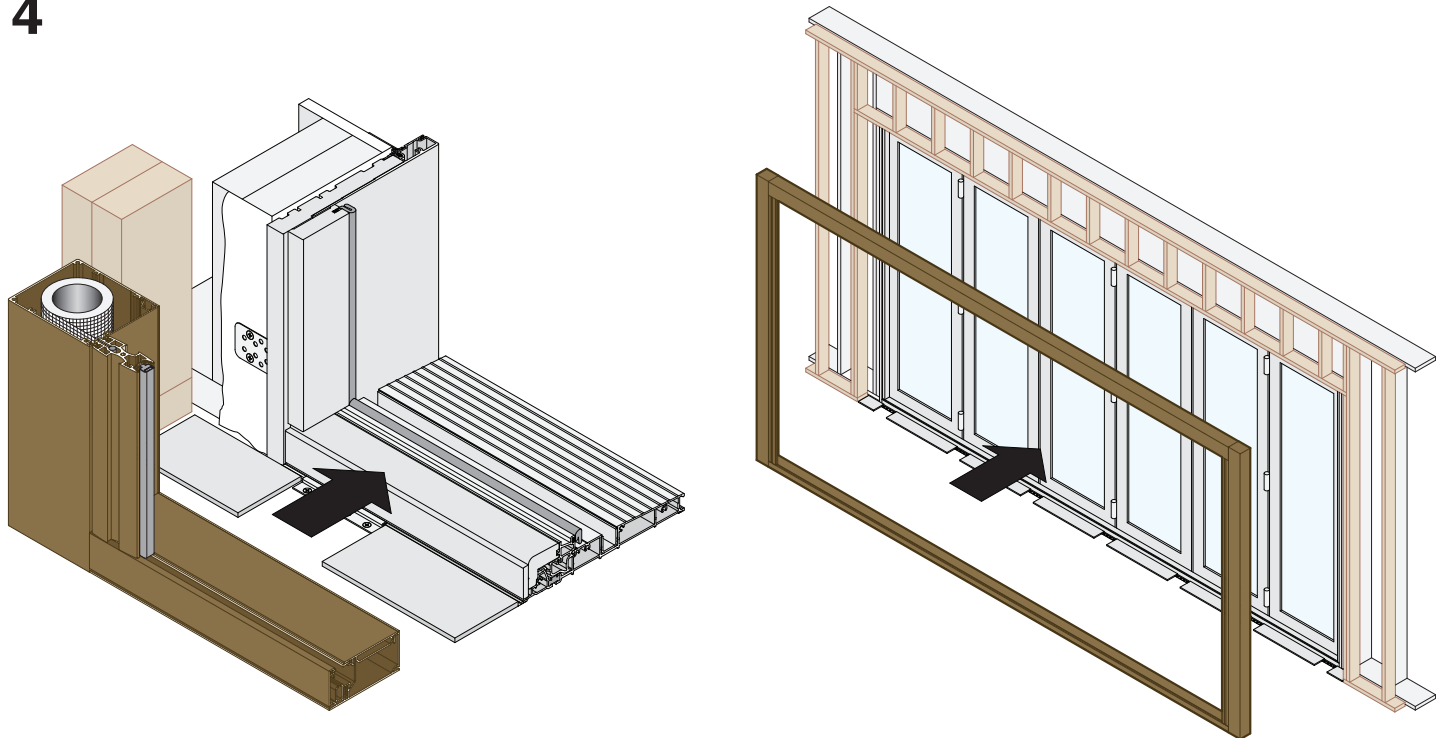

Go to the Retractable Insect Screen Installation Instructions to continue installing the retractable insect screen.

Retractable Insect Screen Sill Shim Application is complete.

**Save Sill Shim
For Retractable
Insect Screen
Installation**

**Save Sill Shim
For Retractable
Insect Screen
Installation**